

**NB-S series**  
**NB7W-TW1□B**

# **Programmable Terminals**

# **USER'S MANUAL**

# **OMRON**

## NOTE

All rights reserved. No part of this publication may be reproduced, stored in a retrieval system, or transmitted, in any form, or by any means, mechanical, electronic, photocopying, recording, or otherwise, without the prior written permission of OMRON.

No patent liability is assumed with respect to the use of the information contained herein. Moreover, because OMRON is constantly striving to improve its high-quality products, the information contained in this manual is subject to change without notice. Every precaution has been taken in the preparation of this manual. Nevertheless, OMRON assumes no responsibility for errors or omissions. Neither is any liability assumed for damages resulting from the use of the information contained in this publication.

## Trademarks

- Sysmac and SYSMAC are trademarks or registered trademarks of OMRON Corporation in Japan and other countries for OMRON factory automation products.
- Microsoft, Windows, Windows Vista, and Excel are either registered trademarks or trademarks of Microsoft Corporation in the United States and other countries.
- EtherCAT® is registered trademark and patented technology, licensed by Beckhoff Automation GmbH, Germany.
- ODVA, CIP, CompoNet, DeviceNet, and EtherNet/IP are trademarks of ODVA.
- The SD and SDHC logos are trademarks of SD-3C, LLC. 

Other company names and product names in this document are the trademarks or registered trademarks of their respective companies.

## Copyrights

Microsoft product screen shots reprinted with permission from Microsoft Corporation.

**NB-S series**  
**NB7W-TW1□B**  
**Programmable Terminals**  
**User's Manual**

*Revised August 2022*



# Introduction

---

Thank you for purchasing an NB-S series Programmable Terminal.

NB-S series Programmable Terminals (PTs) are designed to handle information generated in FA production sites. Be sure to understand the functions and performances etc thoroughly before using PT correctly.

## Intended Audience

This manual is intended for the following personnel, who must also have knowledge of electrical systems (an electrical engineer or the equivalent).

- Personnel in charge of introducing FA systems into production facilities.
- Personnel in charge of designing FA systems.
- Personnel in charge of installing and connecting FA facilities.
- Personnel in charge of managing FA systems and facilities

## General Precautions

- The user must operate the product according to the performance specifications described in the operation manuals.
- Do not use the PT touch switch input functions for applications where danger to human life or serious property damage is possible, or for emergency switch applications.
- Before using the product under conditions which are not described in the manual or applying the product to nuclear control systems, railroad systems, aviation systems, vehicles, combustion systems, medical equipment, amusement machines, safety equipment, and other systems, machines and equipment that may have a serious influence on lives and property if used improperly, consult your OMRON representative.
- Make sure that the ratings and performance characteristics of the product are sufficient for the systems, machines, and equipment, and be sure to provide the systems, machines, and equipment with double safety mechanisms.
- This manual provides information for connecting and setting up an NB-S series PT. Be sure to read this manual before attempting to use the PT and keep this manual close at hand for reference during installation and operation.

# NB-S series Manuals

NB-S series manuals are organized in the sections listed in the following tables. Refer to the appropriate section in the manuals as required.

## Programmable Terminals NB-S series User's Manual (Cat. No. V122) (This Manual)

Section	Contents
<b>PT Setup</b>	
<b>Section 1 Part Names and Functions</b>	This section describes the names and functions of the various parts of an NB Unit.
<b>Section 2 Installing the NB Unit</b>	This section describes the methods used to install the NB Unit.
<b>Section 3 System Setting Mode</b>	This section describes the System Setting Mode.
<b>Section 4 Calibrate Mode</b>	This section describes the Calibrate Mode.
<b>Appendices</b>	The appendices provide information on specifications, dimensions, wirings, and lists of the NB Units and options.
<b>NB-Designer Operation</b>	
<b>Section 1 Introduction</b>	This section provides an outline of the NB-series PTs, including their functions, features, connection types and communication methods.
<b>Section 2 Installation and Startup of NB-Designer</b>	This section describes how to install and start the NB-Designer.
<b>Section 3 Functions of NB-Designer</b>	This section describes the functions of NB-Designer.
<b>Section 4 Functions of NBManager</b>	This section describes the functions of NB-Manager.
<b>Section 5 Maintenance and Abnormality Handling</b>	This section describes the maintenance and check to prevent the abnormality occurrence and the handling of the abnormalities occurred in NB Unit.
<b>Section 6 Functions Related to External Memory</b>	This section describes the functions related to external memory.
<b>Section 7 PictBridge Function</b>	This section describes the PictBridge printing function.
<b>Section 8 Web Interface</b>	This section describes the Web Interface function.
<b>Appendices</b>	The appendices provide lists of the NB Units, the Communication Units, the applicable PLCs, the memories supported by PLC, and the list of NB-Designer functions.

**Note** The basic structure of the chapters in the NB-S series User's Manual is similar to that of the Setup Manual (Cat. No. V107) and Operation Manual (Cat. No. V106) of the NB series.

## Programmable Terminals NB-series Setup Manual (Cat. No. V107)

Section	Contents
<b>Section 1 Part Names and Functions</b>	This section describes the names and functions of the various parts of an NB Unit.
<b>Section 2 Installing the NB Unit and Connecting Peripheral Devices</b>	This section describes the methods used to install the NB Unit and connect peripheral devices.
<b>Section 3 System Setting Mode</b>	This section describes the System Setting Mode.
<b>Section 4 Calibrate Mode</b>	This section describes the Calibrate Mode.
<b>Appendices</b>	The appendices provide information on specifications, dimensions, wirings, and lists of the NB Units, the applicable PLCs and options.

## Programmable Terminals NB-Designer Operation Manual (Cat. No. V106)

Section	Contents
<b>Section 1 Introduction</b>	This section provides an outline of the NB-S series PTs, including their functions, features, connection types and communication methods.
<b>Section 2 Installation and Startup of NB-Designer</b>	This section describes how to install and start the NB-Designer.
<b>Section 3 Functions of NB-Designer</b>	This section describes the functions of NB-Designer.
<b>Section 4 Functions of NBManager</b>	This section describes the functions of NBManager.
<b>Section 5 Maintenance and Abnormality Handling</b>	This section describes the maintenance and check to prevent the abnormality occurrence and the handling of the abnormalities occurred in NB Unit.
<b>Section 6 Functions Related to External Memory</b>	This section describes the functions related to external memory.
<b>Section 7 Pictbridge Printing</b>	This section describes the Pictbridge printing function.
<b>Section 8 Web Interface</b>	This section describes the Web Interface function.
<b>Appendices</b>	The appendices provide lists of the NB Units, the Communication Units, the applicable PLCs, the registers supported by PLC, and the list of NB-Designer functions.

## Programmable Terminals NB-series Host Connection Manual (Cat. No. V108)

Section	Contents
<b>Section 1 List for All PLCs Supported by NB series</b>	This section lists all PLCs supported by NB Units.
<b>Section 2 Connecting to SIEMENS PLCs</b>	This section describes the connection to SIEMENS PLCs.
<b>Section 3 Connecting to Mitsubishi PLCs</b>	This section describes the connection to Mitsubishi PLCs.
<b>Section 4 Connecting to Schneider PLCs</b>	This section describes the connection to Schneider PLCs.
<b>Section 5 Modbus Connection</b>	This section describes the connection on Modbus protocol.
<b>Section 6 Connecting to Delta PLCs</b>	This section describes the connection to Delta PLCs.
<b>Section 7 Connecting to LSIS PLCs</b>	This section describes the connection to LSIS PLCs.
<b>Section 8 Connecting to Panasonic Industrial Devices SUNX PLCs</b>	This section describes the connection to Panasonic Industrial Devices SUNX PLCs.
<b>Section 9 Connecting to Allen-Bradley (Rockwell) PLC</b>	This section describes the connection to Allen-Bradley PLC.
<b>Section 10 Connecting to PLC of GE Fanuc Automation Inc.</b>	This section describes the connection to PLC of GE Fanuc Automation Inc.
<b>Section 11 Connecting to Keyence PLCs</b>	This section describes the connection to Keyence PLCs.
<b>Section 12 Connecting to OMRON Safety Controller</b>	This section describes the connection to OMRON Safety Controller.

## Programmable Terminals NB-series Startup Guide Manual (Cat. No. V109)

Section	Contents
<b>Section 1 NB Overview</b>	This section provide specifications of the NB Unit, describes its names and functions of the various parts.
<b>Section 2 System Design</b>	This section describes the manual structure, takes NB7W as an example to introduce the operation procedures of the NB system.
<b>Section 3 Installation and Wiring</b>	This section describes how to install and wire the NB Unit.
<b>Section 4 Screen Creation</b>	This section describes how to create a demonstration project through NB-Designer.
<b>Section 5 Run</b>	This section describes how to start running at the Host side and prepare to send screen data to NB7W.
<b>Section 6 Maintenance and Troubleshooting</b>	This section describes the maintenance and inspection methods for preventing errors occurring, and troubleshooting measures when errors occur.



### WARNING

Failure to read and understand the information provided in this manual may result in personal injury or death, damage to the product, or product failure. Please read each section in its entirety and be sure you understand the information provided in the section and related sections before attempting any of the procedures or operations given.



# Manual Structure

## Page Structure and Icons

The following page structure and icons are used in this manual.

Level 3 heading

Step in a procedure

Indicates a step in a procedure.

Special Information  
(See below.)

Icons are used to indicate precautions and additional information.

Manual name

2 Installing the NB Unit and Connecting Peripheral Devices

**2-1-2 Installation onto the Operation Panel**

Install the NB Unit by embedding it into the operation panel.  
Use the metal kit and tool (a crosshead screwdriver) supplied with the Unit for installation.  
Proceed the installation following the procedures below.

**1** Panel cutout with dimensions is shown below. Fit the NB Unit into the panel from the front side.

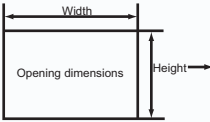
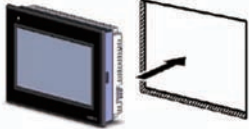
Models	Opening Dimension (W H mm)	
NB3Q-TW00B/TW01B	119.0(+0.5/-0)	93.0(+0.5/-0)
NB5Q-TW00B/TW01B	172.4(+0.5/-0)	131.0(+0.5/-0)
NB7W-TW00B/TW01B	191.0(+0.5/-0)	137.0(+0.5/-0)
NB10W-TW01B	258.0(+0.5/-0)	200.0(+0.5/-0)

**2** As follows, insert panel fixators at the locations indicated by red box around the back of the NB Unit. Insert the hooks of positioners into the square holes on the Unit to hold the fixators properly, and tighten the screws firmly with the screwdriver.

**NB5Q/NB7W-TW□□B**

**Precautions for Safe Use**

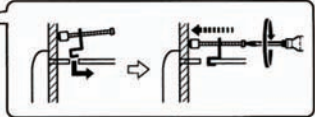
- When operating on the operation panel, make sure to keep metal particles from entering the Unit.

The mounting panel must be between 1.6 and 4.8 mm thick. The NB Unit must be installed in a control panel.

For the sake of waterproof and dustproof, all the fixators must be evenly tightened to a torque of 0.5-0.6 Nm. If the tightening torque exceeds the specified value, or the tightening is not even, deformation of the front panel may occur.

Make sure that the operation panel is clean, unbent, and strong enough for the installation process.

Level 1 heading

Level 2 heading

Level 3 heading

Gives the current headings.



Page tab

Gives the number of the section.

This illustration is provided only as a sample and may not literally appear in this manual.

## Special Information

Special information in this manual is classified as follows:

- 
**Precautions for Safe Use**  
 Precautions on what to do and what not to do to ensure using the product safely.
- 
**Precautions for Correct Use**  
 Precautions on what to do and what not to do to ensure proper operation and performance.
- 
**Additional Information**  
 Additional information to increase understanding or make operation easier.

# Terminology

The following terminology is used in this manual.

Terms	Descriptions
NB Unit	Indicates the main Unit of the products in the OMRON NB-S series of Programmable Terminal.
NB/NB-S Series	Indicates products in the OMRON NB□□ Series of Programmable Terminal. In this manual, unless otherwise specified, NB□□ Series is taken as the subject concerned.
PLC	Indicates a Programmable Controller.
CP Series	Indicates the following products in the OMRON CP Series of Programmable Controllers: CP1H, CP1L, CP1E, CP2E
CS/CJ Series	Indicates the following products in the OMRON CS/CJ Series of Programmable Controllers: CS1G, CS1H, CS1G-H, CS1H-H, CJ1G, CJ1M, CJ2M, CJ2H
NJ/NX Series	Indicates the following OMRON SYSMAC NJ/NX Series of Programmable Controllers: NJ501, NJ301, NJ101, NX102, NX1P2
C Series	Indicates the following products in the OMRON C Series of Programmable Controllers: C200HX(-Z), C200HG(-Z), C200HE(-Z), CPM2C
Serial Communication Unit	Indicates a Serial Communication Unit for an OMRON SYSMAC CS/CJ-Series PLC.
Serial Communication Board	Indicates a Serial Communication Board for an OMRON SYSMAC CS/CJ-Series PLC.
Communication Board	Indicates a Communication Board for an OMRON C200HX/HG/HE(-Z) PLC.
CPU Unit	Indicates a CPU Unit in the OMRON CP, CS/CJ or SYSMAC C Series of Programmable Controllers.
NB-Designer	Indicates the OMRON NB-Designer.
Host	Indicates the PLC and other units functioning as the control devices for NB-S series Units.
PT	Indicates an OMRON Programmable Terminal.

# CONTENTS

---

<b>Introduction.....</b>	<b>1</b>
<b>NB-S series Manuals .....</b>	<b>2</b>
<b>Manual Structure .....</b>	<b>5</b>
<b>Terminology .....</b>	<b>6</b>
<b>Terms and Conditions Agreement .....</b>	<b>15</b>
<b>Safety Precautions .....</b>	<b>17</b>
<b>Precautions for Safe Use .....</b>	<b>22</b>
<b>Precautions for Correct Use .....</b>	<b>24</b>
<b>Conformance to EU Directives .....</b>	<b>25</b>
<b>Related Manuals .....</b>	<b>26</b>

# PT Setup

## Sec. 1 Part Names and Functions..... 1-1

---

- 1-1 Part Names ..... 1-2
- 1-2 Part Specifications ..... 1-3

## Sec. 2 Installing the NB Unit..... 2-1

---

- 2-1 Installing the NB Unit ..... 2-2
  - 2-1-1 Installation environment ..... 2-2
  - 2-1-2 Installation onto the Operation Panel ..... 2-3
  - 2-1-3 Connecting the Power Supply ..... 2-5
  - 2-1-4 Grounding Wiring ..... 2-6
- 2-2 Start of NB-S series ..... 2-7
- 2-3 Connecting of NB-S series with PC ..... 2-9
  - 2-3-1 Connecting by RS-232C ..... 2-9
  - 2-3-2 Connecting by USB ..... 2-10
  - 2-3-3 Connecting by Ethernet ..... 2-11
- 2-4 Serial Communication Connection ..... 2-12
  - 2-4-1 Host Link Connection Method ..... 2-12
  - 2-4-2 Connecting more than one PLC ..... 2-13
  - 2-4-3 Settings for each Unit ..... 2-14
- 2-5 UDP Communication Connection ..... 2-27
  - 2-5-1 Connecting to Host Via Ethernet ..... 2-27
  - 2-5-2 Parameter Settings for UDP at NB Side ..... 2-30
  - 2-5-3 Host Types and Settings of Ethernet Unit ..... 2-32
  - 2-5-4 Host Types and Settings of Ethernet/IP Unit ..... 2-38
  - 2-5-5 Parameter Settings at Host Side (CX-Programmer) ..... 2-43
  - 2-5-6 Parameter Settings at Host Side (Sysmac Studio) ..... 2-44

## Sec. 3 System Setting Mode..... 3-1

---

- 3-1 Display Method of System Setting Mode ..... 3-2
- 3-2 Functions of System Setting Mode ..... 3-3

## Sec. 4 Calibrate Mode ..... 4-1

---

- 4-1 Display Method of Calibrate Mode ..... 4-2
- 4-2 Functions of Calibrate Mode ..... 4-2
- 4-3 On-line Touch-control Calibration Function ..... 4-2

## **Sec. A Appendices.....A-1**

---

<b>A-1</b>	<b>Specifications .....</b>	<b>A-2</b>
A-1-1	General Specifications.....	A-2
A-1-2	Performance Specifications.....	A-2
A-1-3	Communication Specifications.....	A-4
<b>A-2</b>	<b>External Dimensions .....</b>	<b>A-5</b>
<b>A-3</b>	<b>Fabrication of the Connection Cable .....</b>	<b>A-6</b>
A-3-1	Cable Processing.....	A-6
A-3-2	Soldering.....	A-7
A-3-3	Shield Assembly .....	A-7
A-3-4	Method for Fabricating the Cable for Connection to OMRON PLC .....	A-8
A-3-5	Method for fabricating the cable for connection to PC.....	A-9
<b>A-4</b>	<b>List of Models .....</b>	<b>A-10</b>
<b>A-5</b>	<b>List of Options .....</b>	<b>A-13</b>
<b>A-6</b>	<b>Differences of the hardware between NB and NB-S .....</b>	<b>A-14</b>

# NB-Designer Operation

<b>Sec. 1</b>	<b>Introduction .....</b>	<b>1-1</b>
<b>1-1</b>	<b>Functions and Structure of NB-S series PTs .....</b>	<b>1-2</b>
1-1-1	How NB-S series PTs Work at FA Production Sites .....	1-2
1-1-2	Operations of NB-S series PTs .....	1-2
<b>1-2</b>	<b>Communicating with the Host .....</b>	<b>1-4</b>
1-2-1	What's the Host Link? .....	1-4
1-2-2	Connecting Methods .....	1-5
1-2-3	Communicating with the PLC Manufactured by Other Companies .....	1-5
<b>1-3</b>	<b>System Configuration .....</b>	<b>1-6</b>
1-3-1	Connectable Peripheral Devices .....	1-6
<b>1-4</b>	<b>Procedures for NB-S series PTs' Operation .....</b>	<b>1-7</b>
<b>Sec. 2</b>	<b>Installation and Startup of NB-Designer .....</b>	<b>2-1</b>
<b>2-1</b>	<b>Before Installation .....</b>	<b>2-2</b>
<b>2-2</b>	<b>Installation/Uninstallation .....</b>	<b>2-3</b>
2-2-1	Installation Procedure .....	2-3
2-2-2	Uninstallation Procedure .....	2-3
<b>2-3</b>	<b>Startup &amp; Quit .....</b>	<b>2-4</b>
2-3-1	Starting Method .....	2-4
2-3-2	Quitting Method .....	2-4
<b>2-4</b>	<b>Installation of USB Driver for NB .....</b>	<b>2-5</b>
<b>Sec. 3</b>	<b>Functions of NB-Designer .....</b>	<b>3-1</b>
<b>3-1</b>	<b>User Screen .....</b>	<b>3-4</b>
<b>3-2</b>	<b>Menus .....</b>	<b>3-7</b>
3-2-1	File Menu .....	3-7
3-2-2	Edit Menu .....	3-11
3-2-3	View Menu .....	3-16
3-2-4	Screen Menu .....	3-27
3-2-5	Draw Menu .....	3-31
3-2-6	Components Menu .....	3-31
3-2-7	Tools Menu .....	3-32
3-2-8	Option Menu .....	3-32
3-2-9	Window Menu .....	3-33
3-2-10	Help Menu .....	3-34
<b>3-3</b>	<b>NB-Designer Software Window .....</b>	<b>3-35</b>
3-3-1	Project Library Window .....	3-35
3-3-2	Project File Window .....	3-39
3-3-3	Project Work Space .....	3-39
3-3-4	Output Window .....	3-45
3-3-5	Component List Window .....	3-46

<b>3-4</b>	<b>Screen Concept .....</b>	<b>3-47</b>
3-4-1	Screen Types.....	3-47
3-4-2	Screen Property.....	3-50
3-4-3	Screen Creation.....	3-54
3-4-4	Screen Opening.....	3-54
3-4-5	Screen Deletion .....	3-55
3-4-6	Components Related to Screen.....	3-55
<b>3-5</b>	<b>Basic Design Method .....</b>	<b>3-56</b>
3-5-1	Designing Components .....	3-56
3-5-2	About ID No. ....	3-57
3-5-3	Additional Comments (Descriptions) .....	3-58
3-5-4	Read/Write Address for PLC .....	3-59
3-5-5	Vector Graphic.....	3-60
3-5-6	Bitmap.....	3-65
3-5-7	Creating Label .....	3-68
3-5-8	Task Bar and Operation Buttons .....	3-70
3-5-9	Fonts.....	3-72
3-5-10	Basic Properties of Component.....	3-75
3-5-11	Control Setting of Component .....	3-76
3-5-12	Display Setting of Component .....	3-80
<b>3-6</b>	<b>Parts.....</b>	<b>3-82</b>
3-6-1	Bit Button .....	3-82
3-6-2	Bit Lamp.....	3-85
3-6-3	Bit Switch .....	3-88
3-6-4	Command Button.....	3-89
3-6-5	Word Lamp .....	3-96
3-6-6	Word Switch.....	3-98
3-6-7	XY Graph .....	3-102
3-6-8	Moving Component.....	3-111
3-6-9	Animation .....	3-116
3-6-10	Number Input.....	3-118
3-6-11	Number Display .....	3-124
3-6-12	Text Input.....	3-127
3-6-13	Text Display .....	3-131
3-6-14	Level Meter.....	3-132
3-6-15	Analog Meter .....	3-143
3-6-16	Indirect Screen.....	3-147
3-6-17	Direct Screen.....	3-150
3-6-18	Alarm .....	3-152
3-6-19	Data Log .....	3-154
3-6-20	Recipe.....	3-164
3-6-21	Oscillograph.....	3-164
3-6-22	Scroll Bar .....	3-168
3-6-23	Event .....	3-171
3-6-24	Note Book.....	3-178
3-6-25	Word Neon Lamp.....	3-189
3-6-26	Bit Neon Lamp.....	3-190
3-6-27	Touch Trigger .....	3-191
3-6-28	Table.....	3-193
3-6-29	Data History.....	3-194

<b>3-7</b>	<b>Function Parts .....</b>	<b>3-200</b>
3-7-1	Scale .....	3-200
3-7-2	Function Key .....	3-201
3-7-3	Alarm Display .....	3-209
3-7-4	Timer .....	3-213
3-7-5	Bitmap .....	3-218
3-7-6	Vector Graphics .....	3-219
3-7-7	Notepad.....	3-220
3-7-8	Data Transmission .....	3-223
3-7-9	Freeplotting .....	3-226
3-7-10	Date/Time.....	3-227
3-7-11	Indirect Shape .....	3-229
3-7-12	User Information.....	3-233
3-7-13	Multifunction .....	3-233
3-7-14	Event Display .....	3-236
<b>3-8</b>	<b>Project Database .....</b>	<b>3-238</b>
3-8-1	Text Library .....	3-238
3-8-2	Variable Table .....	3-244
3-8-3	Alarm Setting.....	3-248
3-8-4	Event Setting.....	3-253
3-8-5	PLC Control.....	3-257
<b>3-9</b>	<b>Macro Function .....</b>	<b>3-265</b>
3-9-1	Create a Simple Macro Program.....	3-265
3-9-2	Macro and Specification of Operation with Read/Write Variables.....	3-272
3-9-3	Macro Triggering .....	3-273
3-9-4	Other Descriptions .....	3-276
<b>3-10</b>	<b>System Parameters .....</b>	<b>3-291</b>
3-10-1	PT.....	3-292
3-10-2	Task Bar.....	3-294
3-10-3	PT Extended Properties .....	3-296
3-10-4	System Information Setting.....	3-306
3-10-5	Security Levels Setting.....	3-308
3-10-6	User Permission Setting.....	3-310
3-10-7	Event History Setting.....	3-324
3-10-8	COM1 Setting.....	3-325
3-10-9	Ethernet Communication Setting .....	3-327
<b>3-11</b>	<b>Address of System Memory .....</b>	<b>3-328</b>
3-11-1	Local Bit (LB).....	3-329
3-11-2	Local Word (LW) .....	3-334
3-11-3	Nonvolatile Local Word (LW10000~10255) .....	3-339
3-11-4	System Information Table .....	3-340
<b>3-12</b>	<b>Recipe Data .....</b>	<b>3-342</b>
3-12-1	Process of Creating One Recipe Component.....	3-342
3-12-2	Recipe Memory .....	3-344
3-12-3	Upload/Download of Recipe Data between PT and PLC.....	3-348
<b>3-13</b>	<b>Security Level .....</b>	<b>3-353</b>
<b>3-14</b>	<b>Test .....</b>	<b>3-359</b>
3-14-1	Offline test .....	3-359
3-14-2	Direct Online test.....	3-360
3-14-3	Indirect Online test .....	3-361
<b>3-15</b>	<b>Download .....</b>	<b>3-362</b>
3-15-1	Transmission Setting.....	3-362
3-15-2	Download via USB Memory .....	3-365
3-15-3	Specification of Downloading Contents.....	3-365
<b>3-16</b>	<b>Other Functions .....</b>	<b>3-369</b>
<b>3-17</b>	<b>RecipeEditor .....</b>	<b>3-418</b>



## **Sec. 4 Functions of NBManager ..... 4-1**

---

<b>4-1</b>	<b>Introduction of NBManager .....</b>	<b>4-2</b>
<b>4-2</b>	<b>Download Operation .....</b>	<b>4-3</b>
4-2-1	Communication Setting.....	4-3
4-2-2	Select Data .....	4-6
4-2-3	LOGO Setting .....	4-9
4-2-4	Clear Data.....	4-10
<b>4-3</b>	<b>Upload Operation .....</b>	<b>4-12</b>
<b>4-4</b>	<b>System Operation .....</b>	<b>4-15</b>
<b>4-5</b>	<b>Get Version .....</b>	<b>4-16</b>
<b>4-6</b>	<b>Decompile Operation .....</b>	<b>4-17</b>
<b>4-7</b>	<b>Web Interface Operation .....</b>	<b>4-18</b>

## **Sec. 5 Maintenance and Abnormality Handling ..... 5-1**

---

<b>5-1</b>	<b>Maintenance.....</b>	<b>5-2</b>
<b>5-2</b>	<b>Checking and Cleaning.....</b>	<b>5-4</b>
<b>5-3</b>	<b>Abnormality Handling .....</b>	<b>5-6</b>
<b>5-4</b>	<b>Unit Replacement Precautions.....</b>	<b>5-10</b>

## **Sec. 6 Functions Related to External Memory ..... 6-1**

---

<b>6-1</b>	<b>Components Related to External Memory .....</b>	<b>6-2</b>
6-1-1	Function Key.....	6-2
6-1-2	Event, Event History Display and Event Display .....	6-3
6-1-3	Data History, Data Log and XY Graph.....	6-4
6-1-4	Operation Log.....	6-4
6-1-5	Recipe Data.....	6-5
6-1-6	CSV Import / Export.....	6-5
6-1-7	PLC Control .....	6-6
6-1-8	File List .....	6-7
6-1-9	FTP Server .....	6-7

## **Sec. 7 PictBridge Printing ..... 7-1**

---

<b>7-1</b>	<b>PictBridge Function .....</b>	<b>7-2</b>
<b>7-2</b>	<b>Setting Method for Using Printing Function .....</b>	<b>7-4</b>
<b>7-3</b>	<b>Components Related to Printing and Setup Descriptions .....</b>	<b>7-6</b>
7-3-1	PLC Control .....	7-6
<b>7-4</b>	<b>List of System memories Related to Printing .....</b>	<b>7-8</b>
<b>7-5</b>	<b>List of Error Codes for Printing.....</b>	<b>7-9</b>
<b>7-6</b>	<b>Recommended Printer Models.....</b>	<b>7-10</b>

**Sec. 8 Web Interface ..... 8-1**

---

8-1 Defining Web Interface..... 8-2  
8-2 Setup Web Interface on a PC..... 8-3  
8-3 Connection Method and Each Page Function ..... 8-4  
8-4 URL List..... 8-8

**Sec. A Appendices.....A-1**

---

A-1 List of Models .....A-2  
A-2 NB-Designer Function List .....A-5  
A-3 List of memories supported by OMRON PLC .....A-10  
A-4 Usage of Forced Address Bit .....A-15  
A-5 Differences of the software between NB and NB-S.....A-16  
Revision History ..... 1

# Terms and Conditions Agreement

---

## Warranty, Limitations of Liability

### Warranties

---

- **Exclusive Warranty**

Omron's exclusive warranty is that the Products will be free from defects in materials and workmanship for a period of twelve months from the date of sale by Omron (or such other period expressed in writing by Omron). Omron disclaims all other warranties, express or implied.

- **Limitations**

OMRON MAKES NO WARRANTY OR REPRESENTATION, EXPRESS OR IMPLIED, ABOUT NON-INFRINGEMENT, MERCHANTABILITY OR FITNESS FOR A PARTICULAR PURPOSE OF THE PRODUCTS. BUYER ACKNOWLEDGES THAT IT ALONE HAS DETERMINED THAT THE PRODUCTS WILL SUITABLY MEET THE REQUIREMENTS OF THEIR INTENDED USE.

Omron further disclaims all warranties and responsibility of any type for claims or expenses based on infringement by the Products or otherwise of any intellectual property right.

- **Buyer Remedy**

Omron's sole obligation hereunder shall be, at Omron's election, to (i) replace (in the form originally shipped with Buyer responsible for labor charges for removal or replacement thereof) the non-complying Product, (ii) repair the non-complying Product, or (iii) repay or credit Buyer an amount equal to the purchase price of the non-complying Product; provided that in no event shall Omron be responsible for warranty, repair, indemnity or any other claims or expenses regarding the Products unless Omron's analysis confirms that the Products were properly handled, stored, installed and maintained and not subject to contamination, abuse, misuse or inappropriate modification. Return of any Products by Buyer must be approved in writing by Omron before shipment. Omron Companies shall not be liable for the suitability or unsuitability or the results from the use of Products in combination with any electrical or electronic components, circuits, system assemblies or any other materials or substances or environments. Any advice, recommendations or information given orally or in writing, are not to be construed as an amendment or addition to the above warranty.

See <http://www.omron.com/global/> or contact your Omron representative for published information.

### Limitation on Liability; Etc

---

OMRON COMPANIES SHALL NOT BE LIABLE FOR SPECIAL, INDIRECT, INCIDENTAL, OR CONSEQUENTIAL DAMAGES, LOSS OF PROFITS OR PRODUCTION OR COMMERCIAL LOSS IN ANY WAY CONNECTED WITH THE PRODUCTS, WHETHER SUCH CLAIM IS BASED IN CONTRACT, WARRANTY, NEGLIGENCE OR STRICT LIABILITY.

Further, in no event shall liability of Omron Companies exceed the individual price of the Product on which liability is asserted.

## Suitability of Use

---

Omron Companies shall not be responsible for conformity with any standards, codes or regulations which apply to the combination of the Product in the Buyer's application or use of the Product. At Buyer's request, Omron will provide applicable third party certification documents identifying ratings and limitations of use which apply to the Product. This information by itself is not sufficient for a complete determination of the suitability of the Product in combination with the end product, machine, system, or other application or use. Buyer shall be solely responsible for determining appropriateness of the particular Product with respect to Buyer's application, product or system. Buyer shall take application responsibility in all cases.

NEVER USE THE PRODUCT FOR AN APPLICATION INVOLVING SERIOUS RISK TO LIFE OR PROPERTY OR IN LARGE QUANTITIES WITHOUT ENSURING THAT THE SYSTEM AS A WHOLE HAS BEEN DESIGNED TO ADDRESS THE RISKS, AND THAT THE OMRON PRODUCT(S) IS PROPERLY RATED AND INSTALLED FOR THE INTENDED USE WITHIN THE OVER-ALL EQUIPMENT OR SYSTEM.

## Programmable Products

---

Omron Companies shall not be responsible for the user's programming of a programmable Product, or any consequence thereof.

## Disclaimers

### Performance Data

---

Data presented in Omron Company websites, catalogs and other materials is provided as a guide for the user in determining suitability and does not constitute a warranty. It may represent the result of Omron's test conditions, and the user must correlate it to actual application requirements. Actual performance is subject to the Omron's Warranty and Limitations of Liability.

### Change in Specifications

---

Product specifications and accessories may be changed at any time based on improvements and other reasons. It is our practice to change part numbers when published ratings or features are changed, or when significant construction changes are made. However, some specifications of the Product may be changed without any notice. When in doubt, special part numbers may be assigned to fix or establish key specifications for your application. Please consult with your Omron's representative at any time to confirm actual specifications of purchased Product.

### Errors and Omissions

---



Information presented by Omron Companies has been checked and is believed to be accurate; however, no responsibility is assumed for clerical, typographical or proofreading errors or omissions.

# Safety Precautions

## Notation Used for Safety Information

The following notation is used in this manual to provide precautions required to ensure safe usage of the product. The safety precautions that are provided are extremely important to safety. Always read and heed the information provided in all safety precautions.

 <b>WARNING</b>	Indicates an imminently hazardous situation which, if not avoided, will result in death or serious injury. Additionally, there may be severe property damage.
--	---

-  Precautions for Safe Use  
Indicates precautions on what to do and what not to do to ensure using the product safely.
  -  Precautions for Correct Use  
Indicates precautions on what to do and what not to do to ensure proper operation and performance.
- Note** Indicates suggestive information and precautions on operation of the product.

## Symbols



- Prohibition  
Indicates a general prohibition.



- Caution  
Indicates general cautionary, warning, or danger level information.

## **WARNING**

Do not attempt to take the product apart and do not touch the product inside while the power is being supplied. Otherwise it may result in electric shock.



Always ensure that the personnel in charge confirm that installation, inspection, and maintenance were properly performed for the NB Unit.

“Personnel in charge” refers to individuals qualified and responsible for ensuring safety during machine design, installation, operation, maintenance, and disposal.



Ensure that installation and post-installation checks are performed by personnel in charge who possess a thorough understanding of the machinery to be installed.



Do not use the input functions of the touch switch, etc. of the NB Unit, in applications that involve human life, in applications that may result in serious injury, or for emergency stop switches.



Do not attempt to disassemble, repair, or modify the NB Unit. Otherwise it may impair the safety functions.



Never press at two or more points on the touch panel of the NB Unit at a time. Otherwise, it may activate a switch somewhere between the two points.



## Security Measures

### Anti-virus protection

Install the latest commercial-quality antivirus software on the computer connected to the control system and maintain to keep the software up-to-date.



### Security measures to prevent unauthorized access

Take the following measures to prevent unauthorized access to our products.

- Install physical controls so that only authorized personnel can access control systems and equipment.
- Reduce connections to control systems and equipment via networks to prevent access from untrusted devices.
- Install firewalls to shut down unused communications ports and limit communications hosts and isolate control systems and equipment from the IT network.
- Use a virtual private network (VPN) for remote access to control systems and equipment.
- Adopt multifactor authentication to devices with remote access to control systems and equipment.
- Set strong passwords and change them frequently.
- Scan virus to ensure safety of USB drives or other external storages before connecting them to control systems and equipment.



### Data input and output protection

Validate backups and ranges to cope with unintentional modification of input/output data to control systems and equipment.

- Checking the scope of data
- Checking validity of backups and preparing data for restore in case of falsification and abnormalities
- Safety design, such as emergency shutdown and fail-soft operation in case of data tampering and abnormalities



### Data recovery

Backup data and keep the data up-to-date periodically to prepare for data loss.



When using an intranet environment through a global address, connecting to an unauthorized terminal such as a SCADA, HMI or to an unauthorized server may result in network security issues such as spoofing and tampering.

You must take sufficient measures such as restricting access to the terminal, using a terminal equipped with a secure function, and locking the installation area by yourself.



When constructing an intranet, communication failure may occur due to cable disconnection or the influence of unauthorized network equipment.

Take adequate measures, such as restricting physical access to network devices, by means such as locking the installation area.



When using a device equipped with the SD Memory Card function, there is a security risk that a third party may acquire, alter, or replace the files and data in the removable media by removing the removable media or unmounting the removable media.

Please take sufficient measures, such as restricting physical access to the Controller or taking appropriate management measures for removable media, by means of locking the installation area, entrance management, etc., by yourself.





## Precaution



### Wiring

In the case of the NB-S series, when grounding the positive terminal of power supply of 24 V to the NB, do not ground functional grounding terminal at NB side. Some functions of a PC connected to the NB may cause a short circuit and the NB Unit may cause damage.

- Caution:

Depending on the types of PC, SG terminals of RS-232C port or USB port and contour of connector can be connected. As the contour of tool port of the NB and the functional grounding terminal are not insulated, they are connected. Therefore, connecting the PC allows GND terminal and functional grounding terminal of the NB to be connected. If the power supply of 24V to the NB is grounded positively, grounding the functional grounding terminal allows a short circuit as shown in the diagram below and may result in damage.

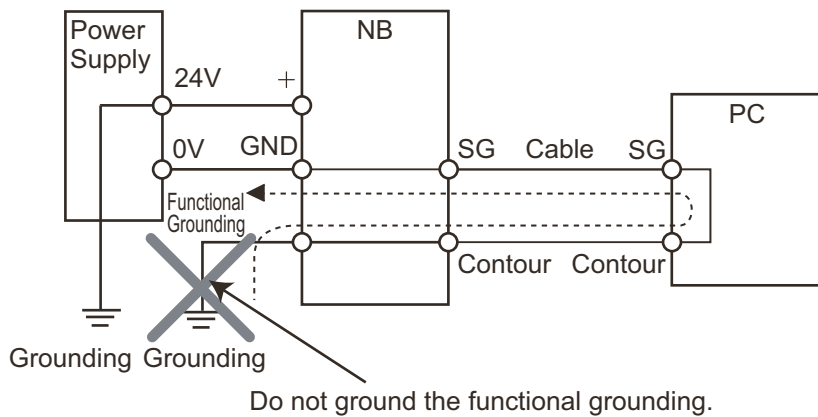

### Test Function

The Test Function is performed on PC, and it has different behaviors with actual NB running system. A problem may occur due to communication timing, cable differences and unexpected PC circumstances (such as freeze). When the Test Function is performed, please consider possible unexpected circumstances on the actual NB running system and confirm that any dangerous event will not occur beforehand.



# Precautions for Safe Use

---

- When unpacking the NB Units and the peripheral devices, check carefully for any external scratches or other damages. Also, shake the Units gently and check for any abnormal sound.
- The NB Unit must be installed in a control panel.
- The mounting panel must be between 1.6 and 4.8 mm thick. Tighten the Mounting Brackets evenly to a torque of between 0.5 and 0.6 N·m to maintain water and dust resistance. If the tightening torque exceeds the specified value, or the tightening is not even, deformation of the front panel may occur. What is more, make sure the panel is not dirty or warped and that it is strong enough to hold the Units.
- Do not let metal particles enter the Units when preparing the panel.
- Do not connect an AC power supply to the DC power terminals.
- Use a DC power with a slight voltage fluctuation and reinforced or double insulation, and that will provide a stable output even if the input is momentarily interrupted for 10 ms.  
Rated Power Supply Voltage: DC 24 V (Allowable range DC 20.4 ~ 27.6 V)
- Do not perform a dielectric voltage test.
- Before connecting the power supply to the NB unit, mount the cable on the terminal block. Make the connection by using terminal screws crimping on a twisted-pair cable with a crimping range of 12~26 AWG, and only 6.5 mm of insulation peel of the cable needs to be peeled off. Tighten the terminal screws at a torque of between 0.3 and 0.5 N·m.
- To prevent malfunctions caused by noise, ground the Unit correctly.
- Do not touch the packaging part of the circuit board with your bare hands. Discharge any static electricity from your body before handling the board.
- When using the No. 6 pin of the serial communication port COM1 connector for a voltage of DC+5V, make sure the supply equipment's current capacity is below 250mA before using it. The DC+5V voltage output of the NB unit is  $+5V \pm 5\%$ , and the maximum current is 250mA.
- Turn OFF the power supply before connecting or disconnecting cables.
- Always keep the connector screws firmly tightened after the communication cable is connected.
- Do not pull on the cables or bend the cables beyond their natural limit.  
Do not place heavy objects on top of the cables or other wiring lines. Doing so may break the cables.
- Confirm the safety of the system before turning ON or OFF the power supply.
- The whole system may stop depending on how the power supply is turned ON or OFF. Turn ON/OFF the power supply according to the specified procedure.
- To ensure the system's safety, make sure to incorporate a program that can confirm the normal functionality of the NB Unit before running the system.
- Start actual system application only after sufficiently checking screen data, macros and the operation of the program at the host side.
- Do not press the touch panel with a force greater than 30 N.
- Do not use hard or pointed objects to operate or scrub the screen, otherwise, the surface of the screen may be damaged.
- Confirm the safety of the system before pressing the touch panel.
- Signals from the touch switches may not be input if the touch switches are pressed consecutively at high speed. Confirm each input before proceeding to the next one.
- Do not accidentally press the touch panel when the backlight is not lit or when the display does not appear. Make sure of the safety of the system before pressing the touch panel.
- To use numeric input functions safely, always make maximum and minimum limit settings.
- Before initializing screen data, confirm that existing data is backed up at the NB-Designer.
- When changing the password with the screen, do not turn OFF the power supply until writing is finished. Failure to save the password may cause the screen to fail to function.

- When using an equipment monitor, confirm the safety of the system before carrying out the following operations:
  - Changing monitor data.
  - Changing operation mode.
  - Forced set/reset.
  - Changing the current value or the set value.
- Commercially available and the recommended USB HUBs are different from the general specifications of the NB Unit. The unit may not function well in an environment subject to noise, static electricity. Therefore, when using a USB HUB, employ sufficient noise and static electricity insulation measures, or install it at a site free of noise or static electricity.
- While uploading or downloading screen data or system programs, do not perform the following operations that may corrupt the screen data or the system program:
  - Turning OFF the power supply of the NB Unit.
- Do not use benzene, paint thinner, or other volatile solvents, and do not use chemically treated cloths.
- Do not dispose the Units together with general waste at waste yards. When disposing them, follow the related local ordinances or rules.
- The backlight lamp inside the NB Unit cannot be replaced.
- Deterioration over time can cause the touch points to move. Calibrate the touch panel periodically.
- Water resistance will be lost if the front sheet is torn or is peeling off. Do not use the Unit, if the front sheet is torn or is peeling off.
- The rubber packing will deteriorate, shrink, or harden depending on the operating environment. Inspect the rubber packing periodically.
- Periodically check the installation conditions in applications where the PT is subject to contact with oil or water.

# Precautions for Correct Use

---

- Do not install the unit in any of the following locations:
  - Locations subject to severe changes in temperature
  - Locations subject to temperatures or humidity outside the range specified in the specifications
  - Locations subject to condensation as the result of high humidity
  - Locations subject to corrosive or flammable gases
  - Locations subject to strong shock or vibration
  - Locations outdoors subject to direct wind and rain
  - Locations subject to strong ultraviolet light
  - Locations subject to dust
  - Locations subject to direct sunlight
  - Locations subject to splashing oil or chemicals
  - Locations subject to continuous water splashing
- Take appropriate and sufficient countermeasures when installing systems in the following locations:
  - Locations subject to static electricity or other forms of noise
  - Locations subject to strong electric field or magnetic field
  - Locations close to power supply lines
  - Locations subject to possible exposure to radioactivity
- Precautions for software:
  - The update, restoration, uninstall and reinstallation of software in running status is prohibited in order to guarantee the correct use of the product.

# Conformance to EU Directives

NB-S series Programmable Terminals are EMC compliant.

## Concepts

OMRON products are electronic devices that are incorporated in machines and manufacturing installations. OMRON PTs conform to the related EMC Directives (see note) so that the devices and machines into which they are built can more easily conform to EMC Directives. The actual products have been through inspections and are completely in accordance with EMC directives. However, when they are built into customers' systems, whether the systems also comply with these Directives is up to the customers for further inspection.

EMC-related performance of OMRON PTs will vary depending on the configuration, wiring, and other conditions of the OMRON equipment or control panel. The customer must, therefore, perform final checks to confirm that the overall machine or device conforms to EMC standards.

**Note** The applicable EMC (Electromagnetic Compatibility) standards are as follows:  
EMS (Electromagnetic sensitivity): EN61131-2: 2007  
EMI (Electromagnetic Interference): EN61131-2: 2007

## Conformance to EU Directives

NB-S series Programmable Terminals are EU compliant. Heed the following precautions in order to ensure that the customer's overall machine and device conform to EU Directives.

- 1** The PT must be installed in a control panel.
- 2** You must use reinforced insulation or double insulation for the DC power supply and the DC power supply must have minimal voltage fluctuations and provide a stable output even if the power supply input is interrupted for 10 ms.
- 3** The PTs conform to the standard EN 61131-2, but radiated emission characteristics (10m regulations) may vary depending on the configuration of the control panel used, other devices connected to the control panel, wiring, and other conditions. You must therefore confirm that the overall machine or equipment complies with EU Directives.
- 4** This is a Class A product (Product for industry purpose). It may cause radio interference in residential areas, in which case the user may be required to take adequate measures to reduce interference.

## Conformance to KC Standards

Observe the following precaution if you use NB-series Programmable Terminals in Korea.

A 급 기기 (업무용 방송통신기자재)  
이 기기는 업무용(A 급) 전자파적합기기로서 판매자  
또는 사용자는 이 점을 주의하시기 바라며, 가정외의  
지역에서 사용하는 것을 목적으로 합니다.

Class A Device (Broadcasting Communications Device for Office Use)

This device obtained EMC registration for office use (Class A), and it is intended to be used in places other than homes. Sellers and/or users need to take note of this.

# Related Manuals

The related manuals are as follows:

Devices and Software	Manual Name	Manual No.
NB-S series	NB-S Series User's Manual (This manual)	V122
NB series	NB Series NB-Designer Operation Manual	V106
	NB Series Setup Manual	V107
	NB Series Host Connection Manual	V108
	NB Series Startup Guide	V109
PLC	SYSMAC CP Series CP1L CPU Unit Operation Manual	W462
	SYSMAC CP Series CP1H/L CPU Unit Programming Manual	W451
	SYSMAC CP Series CP1H CPU Unit Operation Manual	W450
	SYSMAC CP Series CP1E CPU Unit Hardware USER'S Manual	W479
	SYSMAC CP Series CP1E CPU Unit Software USER'S Manual	W480
	SYSMAC CP Series CP1E/CP2E CPU UNIT INSTRUCTIONS REFERENCE MANUAL	W483
	SYSMAC CP Series CP1L-EL/EM CPU Unit Operation Manual	W516
	SYSMAC CP Series CP2E CPU Unit Hardware USER'S MANUAL	W613
	SYSMAC CP Series CP2E CPU Unit Software USER'S MANUAL	W614
	SYSMAC C200HX/HG/HE(-E/-ZE) Installation Guide	W302
	SYSMAC C200HX/HG/HE Operation Manual	W303
	SYSMAC C200HX/HG/HE(-ZE) Operation Manual	W322
	SYSMAC CPM1/CPM1A/CPM2A/CPM2C/SRM1(-V2) Programming Manual	W353
	SYSMAC CPM2C Operation Manual	W356
	SYSMAC CS1 Series CS1G/H Operation Manual	W339
	SYSMAC CS/CJ Series Serial Communications Boards and Serial Communications Units Operation Manual	W336
	SYSMAC CJ Series CJ1G/H(-H) CJ1M CJ1G Operation Manual	W393
	SYSMAC CS/CJ Series Programming Manual	W394
	SYSMAC CS/CJ Series INSTRUCTIONS Reference Manual	W340
	SYSMAC CS/CJ Series Programming Consoles Operation Manual	W341
	SYSMAC CS/CJ Series Communications Commands Reference Manual	W342
	SYSMAC CJ Series CJ2 CPU Unit Hardware USER'S Manual	W472
	SYSMAC CJ Series CJ2 CPU Unit Software USER'S Manual	W473
	SYSMAC CS/CJ Series CS1W/CJ1W-ETN21 (100Base-TX) Ethernet Units Operation Manual Construction of Networks	W420
	SYSMAC CS/CJ Series CS1W/CJ1W-ETN21 (100Base-TX) Ethernet Units Operation Manual Construction of Applications	W421
	SYSMAC CS/CJ Series CS1W/CJ1W-EIP21 (100Base-TX) EtherNet/IP™ Units Operation Manual	W465
	NJ Series CPU Unit Hardware USER'S Manual	W500
	NJ/NX Series CPU Unit Software USER'S Manual	W501
	NJ/NX Series CPU Unit Built-in EtherNet/IP™ Port USER'S Manual	W506
	NJ/NX Series Troubleshooting Manual	W503
	NX-Series NX102 CPU Unit Hardware User's Manual	W593
	NX-Series NX1P2 CPU Unit Hardware User's Manual	W578
	NX-Series NX1P2 CPU Unit Built-in I/O and Option Board User's Manual	W579
External Tool	CX-Programmer Ver.9.□ Operation Manual	W446
	Sysmac Studio Version 1 Operation Manual	W504

# 1

## Part Names and Functions

This section describes the names and functions of the various parts of an NB Unit.

---

<b>1-1</b>	<b>Part Names</b> .....	<b>1-2</b>
<b>1-2</b>	<b>Part Specifications</b> .....	<b>1-3</b>

# 1-1 Part Names

● NB7W-TW10B/NB7W-TW11B model

Front view

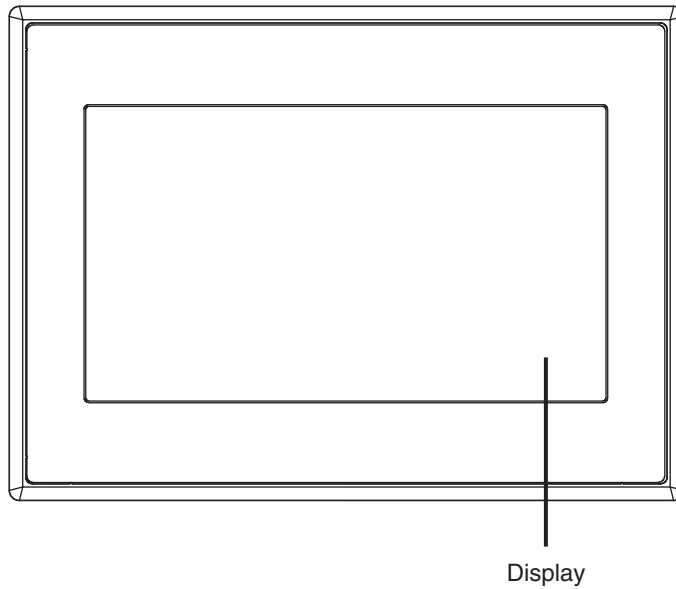

Back view

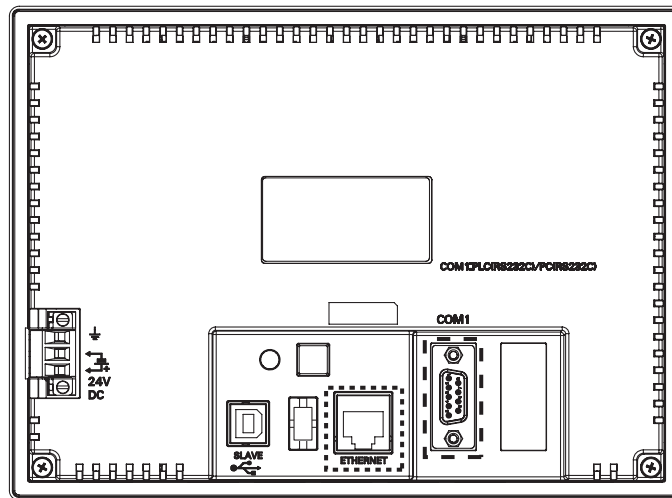

--- : NB7W-TW10B only

--- : NB7W-TW11B only



### Precautions for Safe Use

Confirm the safety of the system before turning ON or OFF the power supply.



## 1-2 Part Specifications

### ● Touch Panel

Input operation can be carried out by means of the touch panel. By pressing the touch panel, the screens can be switched, and the contact information can be transmitted to the host. Analog touch panel with 1024 × 1024 resolution is employed.

#### WARNING

Do not use the input functions of the touch switch, etc. of the NB Unit, in applications that involve human life, in applications that may result in serious injury, or for emergency stop switches.



Never press at two or more points on the touch panel of the NB Unit at a time. Otherwise, it may activate a switch somewhere between the two points.



#### Precautions for Safe Use

- Do not press a touch switch with a force greater than 30N.
- Do not accidentally press the touch panel when the backlight is not lit or when the display does not appear. Make sure of the safety of the system before pressing the touch panel.
- Confirm the safety of the system before pressing the touch panel.
- Do not use hard or pointed objects to operate or scrub the screen, or the surface of the screen may be damaged.
- Signals from the touch switches may not be input if the switches are pressed consecutively at high speed. Confirm each input before proceeding to the next one.
- Deterioration over time can cause the touch points to move. If deviation of the touch points stands out, calibrate the touch panel periodically.

### ● Serial Port COM1

- NB7W-TW10B

Serial port COM1 is a 9-pin D-type socket port. This port supports RS-232C communication function, making it connectable to a controller which features RS-232C function, and it can also be used for downloading programs or debugging for the product.

The pins are defined as follows:



Pins	Signals	I/O	Functions
1	NC	-	-
2	SD	O	Sending data
3	RD	I	Receiving data
4	RS(RTS)	O	Request to send*
5	CS(CTS)	I	Clear to send*
6	DC+5V	-	DC+5V output (Max. current: 250mA)
7	NC	-	-
8	NC	-	-
9	SG	-	Signal ground

\* Pins 4 and 5 are not used, thus not compliant with RS or CS functions.



**Precautions for Safe Use**

When using the No. 6 pin of the serial communications port COM1 connector for a voltage of DC+5V, make sure the supply equipment's current capacity is below 250 mA before using it. The DC+5V voltage output of the NB Unit is +5V±5%, and the maximum current is 250 mA.

**● USB SLAVE**

USB SLAVE port is USB B-type port, which can connect the USB port on PC side to perform the uploading, downloading and debugging of the programs for the product and the Pictbridge printing. And its pins are defined as follows:

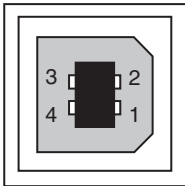

Pins	Signals	Functions
1	Vbus	Vbus
2	D-	Data -
3	D+	Data +
4	GND	Vbus ground

**● Ethernet Interface**

NB7W-TW11B is equipped with Ethernet Interface, which is adaptive RJ-45 type interface with the transmission rate of 10M/100M. It can be connected with PC to perform the uploading and downloading of the programs and the system initialization, and can also be used to realize the communication with the controller supporting the Ethernet communication. And its pins are defined as follows:

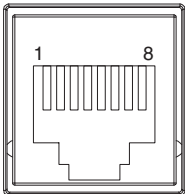

Pins	Signals	Functions
1	TD+	Sending data +
2	TD-	Sending data -
3	RD+	Receiving data +
4	---	Not used
5	---	Not used
6	RD-	Receiving data -
7	---	Not used
8	---	Not used

# 2

## Installing the NB Unit

This section describes the methods used to install the NB Unit and connect peripheral devices.

---

<b>2-1</b>	<b>Installing the NB Unit</b>	<b>2-2</b>
2-1-1	Installation environment	2-2
2-1-2	Installation onto the Operation Panel	2-3
2-1-3	Connecting the Power Supply	2-5
2-1-4	Grounding Wiring	2-6
<b>2-2</b>	<b>Start of NB-S series</b>	<b>2-7</b>
<b>2-3</b>	<b>Connecting of NB-S series with PC</b>	<b>2-9</b>
2-3-1	Connecting by RS-232C	2-9
2-3-2	Connecting by USB	2-10
2-3-3	Connecting by Ethernet	2-11
<b>2-4</b>	<b>Serial Communication Connection</b>	<b>2-12</b>
2-4-1	Host Link Connection Method	2-12
2-4-2	Connecting more than one PLC	2-13
2-4-3	Settings for each Unit	2-14
<b>2-5</b>	<b>UDP Communication Connection</b>	<b>2-27</b>
2-5-1	Connecting to Host Via Ethernet	2-27
2-5-2	Parameter Settings for UDP at NB Side	2-30
2-5-3	Host Types and Settings of Ethernet Unit	2-32
2-5-4	Host Types and Settings of Ethernet/IP Unit	2-38
2-5-5	Parameter Settings at Host Side (CX-Programmer)	2-43
2-5-6	Parameter Settings at Host Side (Sysmac Studio)	2-44

## 2-1 Installing the NB Unit

This section describes the methods used to mount the NB Unit onto an operation panel and connect the power supply.

### 2-1-1 Installation environment

When mounting the NB Unit onto the operation panel, pay attention to the following precautions.

#### WARNING

Always ensure that the personnel in charge confirm that installation, inspection, and maintenance were properly performed for the NB Unit.

“Personnel in charge” refers to individuals qualified and responsible for ensuring safety during machine design, installation, operation, maintenance, and disposal.



Ensure that installation and post-installation checks are performed by personnel in charge who possess a thorough understanding of the machinery to be installed.



#### Precautions for Correct Use

- Do not install the product in any of the following locations:
  - Locations subject to rapid changes in temperature
  - Locations subject to temperatures or humidity outside the range specified in the specifications
  - Locations subject to condensation as the result of high humidity
  - Locations subject to corrosive or flammable gases
  - Locations subject to strong shock or vibration
  - Locations outdoors subject to direct wind and rain
  - Locations subject to strong ultraviolet light
  - Locations subject to dust
  - Locations subject to direct sunlight
  - Locations subject to splashing oil or chemicals
  - Locations subject to continuous water splashing
- Take appropriate and sufficient countermeasures when the product is used in the following locations:
  - Locations subject to static electricity or other forms of noise
  - Locations subject to strong electric field or magnetic field
  - Locations close to power supply lines
  - Locations subject to possible exposure to radioactivity



#### Precautions for Safe Use

When unpacking the NB Units and the peripheral devices, check carefully for any external scratches or other damage. Also, shake the Units gently and check for any abnormal sound.

## 2-1-2 Installation onto the Operation Panel

Install the NB Unit by embedding it into the operation panel.

Use the panel mounting brackets and Phillips screwdriver for installation.

Proceed the installation following the procedures below.

- 1 Panel cutout with dimensions is shown below. Fit the NB Unit into the panel from the front side.

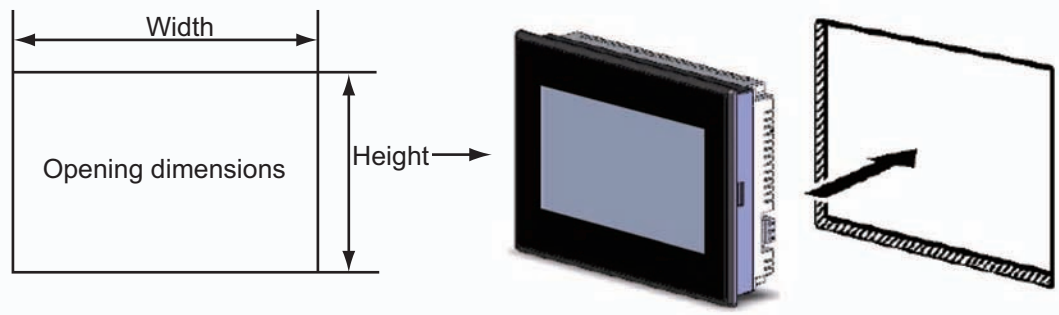

Models	Opening Dimension (W×H mm)
NB7W-TW10B/TW11B	191.0(+0.5/-0)×137.0(+0.5/-0)

- 2 As follows, insert the panel mounting brackets at the locations indicated by red box around the back of the NB Unit. Insert the hooks of positioners into the square holes on the Unit to hold the fixators properly, and tighten the screws firmly with the screwdriver.

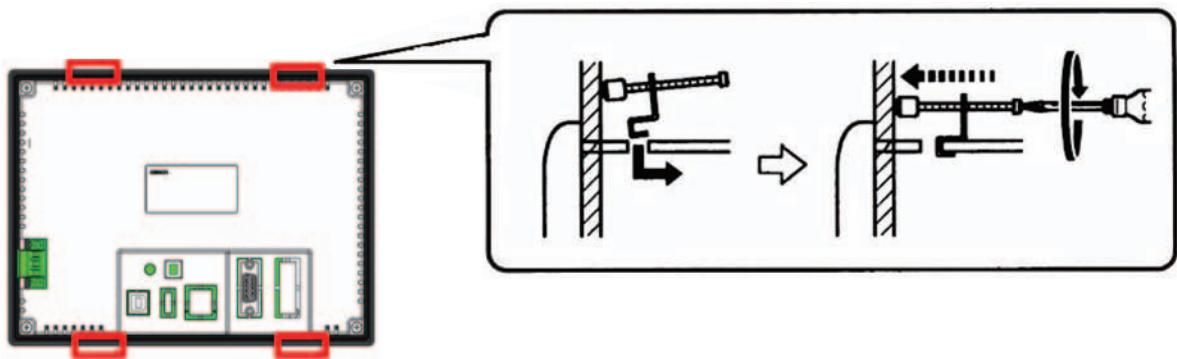

### Precautions for Safe Use

- Do not let metal particles enter the Units when preparing the panel.
- The mounting panel must be between 1.6 and 4.8 mm thick. Tighten the Mounting Brackets evenly to a torque of between 0.5 and 0.6 N·m to maintain water and dust resistance. If the tightening torque exceeds the specified value, or the tightening is not even, deformation of the front panel may occur. What is more, make sure the panel is not dirty or warped and that it is strong enough to hold the Units.

● **Display Mode of NB-S series touch panel**

NB-S series touch panel has 2 display modes: horizontal and vertical.  
The display mode can be selected when dragging a PT from Project Library Window into Configuration and Setup Window.

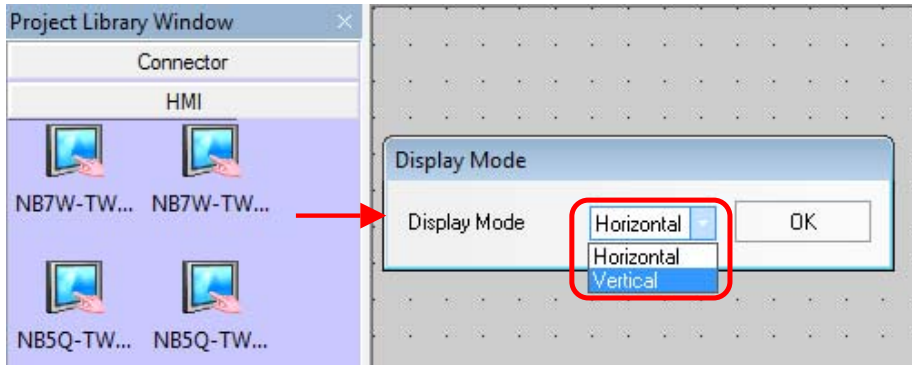

Horizontal display



Vertical display

When oriented vertically (vertical display), the power supply terminal block is on the top side.

## 2-1-3 Connecting the Power Supply



### Precautions for Safe Use

- Do not connect an AC power supply to the DC power terminals.
- Use a DC power with a slight voltage fluctuation and reinforced or double insulation, and that will provide a stable output even if the input is momentarily interrupted for 10 ms.  
Rated Power Supply Voltage: DC 24 V (Allowable range DC 20.4 ~ 27.6 V)

### ● Power Supply

The connectable power supply specifications are as follows: figure out a suitable power supply specification so as to satisfy the requirement for power supply capacity.

Models	Rated Voltage	Allowable Voltage Range	Power
NB7W-TW10B	DC24V	DC20.4V to 27.6V	7W
NB7W-TW11B			6W

### ● NB7W-TW1□B

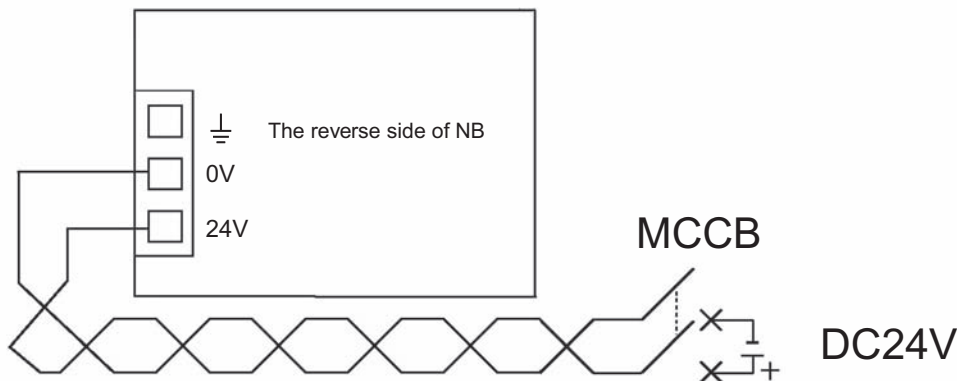

### Precautions for Safe Use

- Before connecting the power supply to the NB unit, mount the cable on the terminal block. Make the connection by using terminal screws crimping on a twisted-pair cable with a crimping range of 12~26 AWG, and only 6.5 mm of insulation peel of the cable needs to be peeled off. Tighten the terminal screws at a torque of between 0.3 and 0.5 N·m. Make sure the screws are properly tightened.

### 2-1-4 Grounding Wiring

The NB Unit has a functional grounding terminal ( $\perp$ ).

Arrange the wiring according to the following conditions.

- 1** When a potential difference occurs between the NB Unit and the host, arrange the grounding as illustrated. If the distance is too long to realize a single-point grounding, do not ground the  $\perp$  of the NB Unit.
- 2** When the NB Unit, and noise source equipment such as motors and inverters, etc. are installed on the same panel, do not ground the  $\perp$  of the NB Unit.

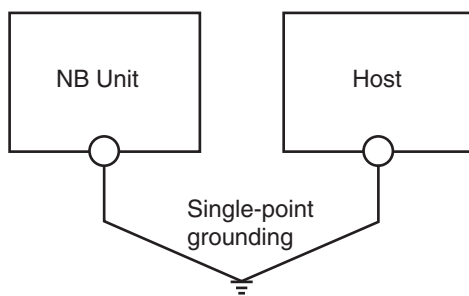

#### Precautions for Safe Use

---

To prevent malfunctions caused by noise, ground the Unit correctly.

---



## 2-2 Start of NB-S series

Confirm the hardware are all correctly connected, turn on the power supply, and start the NB-S series. This part describes the operations of the NB-S series when it starts.

### ● Opening the Start Menu

You can change the operation mode of the NB unit in the Start Menu.

The NB has the operation modes below.

- **System Setting Mode:** The PT will be launched into a built-in system setup screen, and is subject to the user for the settings of brightness, system time, buzzer and Pict-bridge printing function.
- **Calibrate Mode:** When the user touches the panel, a symbol "+" will pop up on the screen, with which the touch control precision level can be calibrated.
- **Downloader Mode:** This is used for updating Kernel and root file system.
- **User Project Mode:** This is used to display the downloaded user projects.

You can display the Start Menu by turning on the power of the NB unit while pressing the upper left corner of the touch panel of the NB unit.

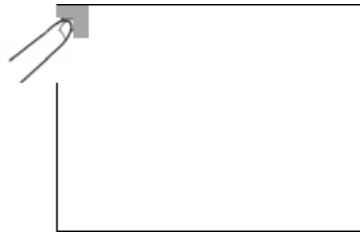

To enter an operation mode, press the button for that operation mode in the Start Menu.

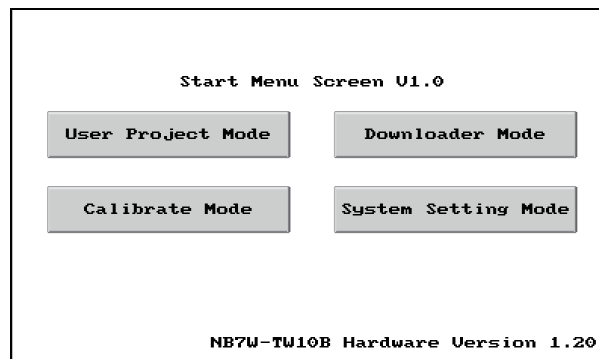

- **When starting the NB Unit for the first time**

- (1) To enter System Setting Mode, press the [System Setting Mode] button in the Start Menu.
- (2) Through the System Setup screen, the system time, starting window No., screen saving time, buzzer and the screen brightness can be set. When the setup is finished, turn OFF the power supply, and then switch on the power supply again.

- **When starting the NB Unit after downloading the screen data to it.**

- (1) Turn on the power supply of the NB Unit, the NB Unit starts.
- (2) The starting screen of the screen data downloaded to the NB Unit will be shown.

- **Entering into Calibrate Mode.**

- (1) To enter Calibrate Mode, press the [Calibrate Mode] button in the Start Menu.
- (2) When the user touches the panel, a symbol "+" will pop up on the screen, with which the touch control precision level can be calibrated.



---

**Precautions for Safe Use**

---

Confirm the safety of the system before turning ON or OFF the power supply.

---

## 2-3 Connecting of NB-S series with PC

In order to transmit the screen data established by the NB-Designer to the NB Unit, the NB Unit needs to be connected to a PC with a RS-232C, USB or Ethernet cable.

### 2-3-1 Connecting by RS-232C

Take NB7W-TW10B as example:

Connect the RS-232C cable at the PC side to the serial port COM1 of the NB Unit.

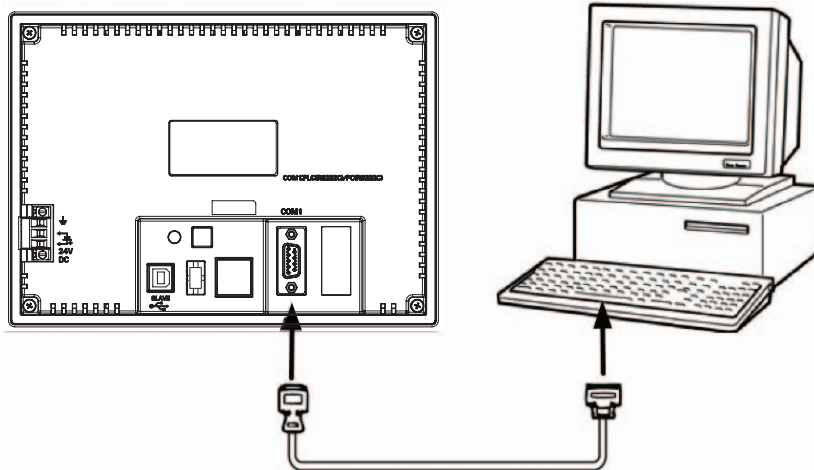

- **Communication conditions**

Select the downloader mode through the tool menu of the NB-Designer. For details, refer to 3-15 *Download* in *NB-Designer Operation*.

- **Communication cable**

Users can make connection cables by themselves. For details, refer to A-3 *Fabrication of the Connection Cable* in *PT Setup*.

### 2-3-2 Connecting by USB

Use the USB transmission cable to connect the USB A-type port on PC side with the USB SLAVE B-type port on NB Unit. As to the USB connection, there are some preparations and restrictions that need to be done or heeded. Refer to the following content to ensure a correct connection.

Take NB7W-TW1□B as example:

Connect the USB port at the PC side and the USB slave connector of the NB Unit.

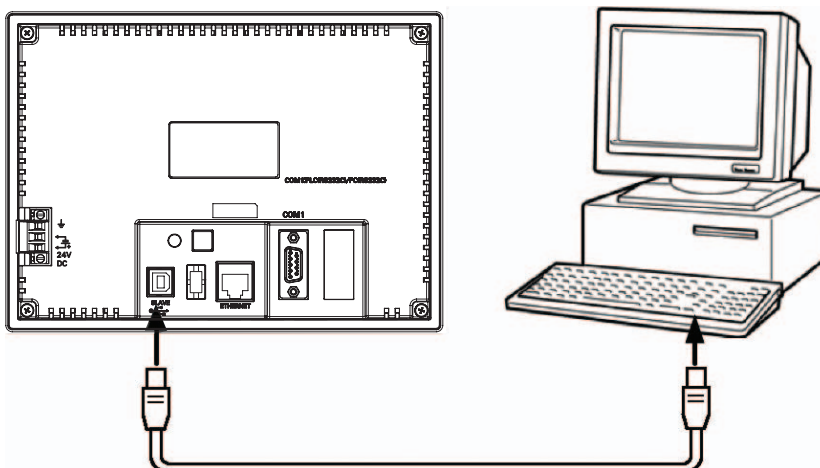

#### ● USB driver for the NB-Designer

A USB driver needs to be installed in the PC for the purpose of transmitting screen data through USB. The USB driver should be installed at the first time when connecting the NB Unit to a PC.

Please refer to *2-4 Installation of USB-Driver for NB* in *NB-Designer Operation* for details on the USB driver.



#### Precautions for Safe Use

- Commercially available and the recommended USB HUBs are different from the general specifications of the NB Unit. The Unit may not function well in an environment subject to noise, static electricity. Therefore, when using a USB HUB, employ sufficient noise and static electricity insulation measures, or install it at a site free of noise or static electricity.
- Do not connect a USB connector to any device that is not applicable.
- Before connecting a USB connector to a device, make sure that the device is free of damage.

### 2-3-3 Connecting by Ethernet

PT with model number of NB7W-TW11B can perform the uploading & downloading of data (such as user project and recipe etc.) and the refreshing of PT firmware through connecting the Ethernet cable with RJ45 connectors on both ends and the network interface on PC side.

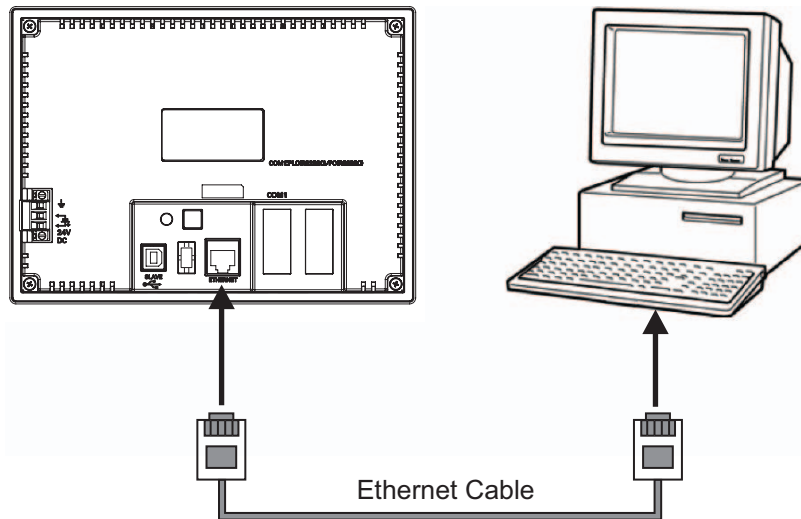

#### ● Communication conditions

Select the corresponding download method by clicking the Download Way option in Tools menu of the NB-Designer. For details, refer to 3-15 Download in *NB-Designer Operation*.

## 2-4 Serial Communication Connection

### 2-4-1 Host Link Connection Method

Host Link is a connection method in which one PLC is connected to one NB Unit.

- **The RS-232C connection method using serial ports COM1**

This is the simplest and most feasible method.

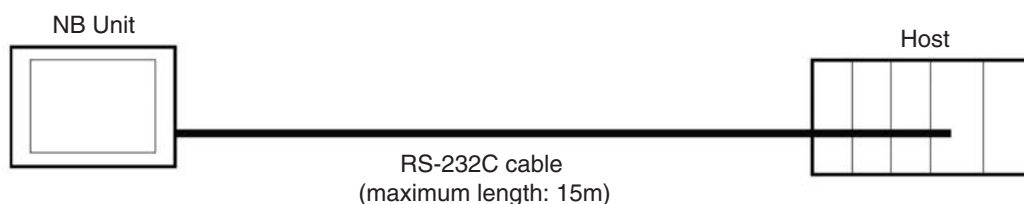

The following cables are recommended.

XW2Z-200T (Cable length: 2m) by OMRON

XW2Z-500T (Cable length: 5m) by OMRON

- **Connectable Units at the host side**

When using OMRON PLCs, the Units with built-in Host Link function vary depending on models and series. There is also the CPU Unit connected in a Host Link method through adding the serial communication unit or communication option board.

When connecting, confirm the connected PLC's series, model and the models of the installed circuit board/Unit.

As to the Units at the host side which can be connected to NB-S series Unit by RS-232C through a Host Link, refer to *A-4 List of Models in PT Setup*.

- **Communication setting**

The communication settings need to be set as following values before carrying out communications in the Use Host link.

Items	Settings
Data bit	7bit
Stop bit	2bit
Parity check	Even
Communication speed	Any value, but the values for the NB Unit and the host must be the same.
Station No.	00

Settings at the NB Unit should be specified from the [Configuration and Setup Window] in NB-Designer. For details, refer to *3-10-8 COM1 Setting in NB-Designer Operation*.

For communication settings at the host side, refer to the related PLC manuals as needed.

## 2-4-2 Connecting more than one PLC

PT with the model number of NB7W-TW11B, which supports Ethernet, can connect single PLC or multiple PLCs simultaneously through the Ethernet (through the router). When connecting with multiple PLCs, it can connect the Host manufactured by the same manufacture or different manufactures simultaneously.

**Note** Multiple Communications systems cannot be used simultaneously by the same COM port.



### Precautions for Safe Use

---

- Be sure to press in the cable until it locks into place.
  - The maximum tensile load for cables is 30N. Do not apply loads greater than this.
-

### 2-4-3 Settings for each Unit

When connecting with the serial communication ports, the settings for each Unit are as follows:

#### When connecting to CP-Series CPU Units

CP1L-L14/L20/M30/M40/M60 models  
 CP1H-X40/XA40/Y20 models  
 CP1E-N14/N20 models  
 CP1E-N30/N40/N60/NA20 models  
 CP1L-EL20/EM30/EM40 models  
 CP2E-N14/N20 models  
 CP2E-N30/N40/N60 models  
 CP2E-S30/S40/S60 models  
 CP2E-E14/E20 models  
 CP2E-E30/E40/E60 models

#### ● PLC System Settings Area

Write settings directly into the [PLC System Settings Area] with a peripheral tool (CX-Programmer, etc.) based on the model and port of the host.

Host model and Port No.	Channel No. (*1)	Write Value	Setting
CP1L-M30/M40/M60, serial port 1	144	8000	Use Host Link
CP1H-X40/XA40/Y20, serial port 1	145	0000~000A(*2)	Communication speed
CP1L-EM30/EM40, serial port 1	147	0000~001F	Unit number
CP1L-L14/L20, serial port 1	160	8000	Use Host Link
CP1L-M30/M40/M60, serial port 2	161	0000~000A(*2)	Communication speed
CP1H-X40/XA40/Y20, serial port 2	163	0000~001F	Unit number
CP1L-EL20, serial port 1			
CP1L-EM30/EM40, serial port 2			

Host model and Port No.	Channel No.	Write Value	Setting
CP1E-N14/N20, serial port 1	A617.15~12	0	Use Host Link
CP1E-N30/N40/N60/NA20, serial port 1	A617.11~08	0, 3~A(*2)	Communication speed
CP2E-S30/S40/S60, Built-in RS-232C Port	A617.07~00	00	7 data bits, 2 stop bits, Even
CP2E-E14/E20, Built-in RS-232C Port			
CP2E-E30/E40/E60, Built-in RS-232C Port			
CP2E-N14/N20, serial port 1			
CP2E-N30/N40/N60, serial port 1			
CP1E-N30/N40/N60/NA20, serial port 2	A618.15~12	0	Use Host Link
CP2E-N30/N40/N60, serial port 2 (*3)	A618.11~08	0, 3~A(*2)	Communication speed
	A618.07~00	00	7 data bits, 2 stop bits, Even

\*1 The channel No. of CP1L/H is PLC Setup area.

\*2 The communication speed should be set to the same value as that of the NB Unit.

\*3 The NB cannot be connected to the CP2E series Built-in RS-485 Port (2-wire).

#### ● Settings for the front-side DIP Switches

Set the front-side DIP switches so as to validate the settings for [PLC System Settings Area].

Set the SW4 to OFF when serial port 1 is used, set SW5 to OFF when serial port 2 is used. As the CP1L-L has only one serial port, it has no DIP switch SW5.

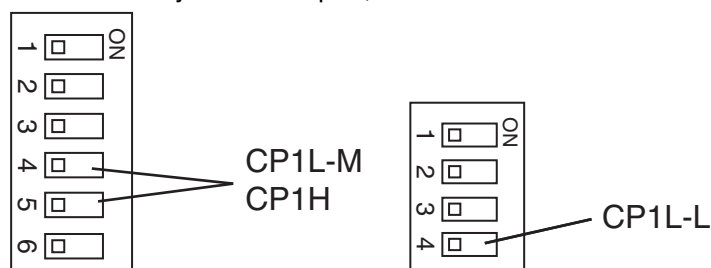



## When connecting to C-Series CPU Units

C200HX/HG/HE(-Z), CPM2C type CPU Units

### ● Connection Methods

The connection methods for the CPU Units of different PLC models.

PLC Models	RS-232C connection
C200HX/HG/HE(-Z)	<ul style="list-style-type: none"> <li>Connect to the RS-232C port built in the CPU Unit</li> <li>Connect to the RS-232C port (Ports A, B) of the serial communication board</li> </ul>
CPM2C	<ul style="list-style-type: none"> <li>Connect to the RS-232C port built in the CPU Unit or the peripheral port with a dedicated conversion cable (CPM2C-CN111 type, CS1W-CN118 type and CS1W-CN114 type) (CPM2C-CN111 type is a cable that divides the Unit port into the RS-232C port built in the CPU Unit and the peripheral port. When connecting to the peripheral port, a RS-232C adaptor (CPM1-CIF01 type) is also needed to be connected.)</li> </ul>



### Precautions for Safe Use

The C-Series CPU does not support the automatic clock adjustment function of the NB7W-TW1□ series. If a communication error occurs when connected to the NB7W-TW1□ series, do not use the automatic clock adjustment function.

### ● PLC System Settings Area

Write settings directly into the [PLC System Settings Area] (Data memory) with a peripheral tool (CX-Programmer, etc.) based on the model and port of the host.

For RS-232C

Host Model	Channel No.	Write Value	Setting
The RS-232C port built in C200HX/HG/HE(-Z), CPM2C	DM6645	0001	Use Host Link
	DM6646	03□□(*2)	Communication conditions are standard settings. (*3)
	DM6648	0000	Unit No. 00
Port A of C200HX/HG/HE(-Z) (*1)	DM6555	0001	Use Host Link
	DM6556	03□□(*2)	Communication conditions are standard settings. (*3)
	DM6558	0000	Unit No. 00
Port B of C200HX/HG/HE(-Z) (*1)	DM6550	0001	Use Host Link
	DM6551	03□□(*2)	Communication conditions are standard settings. (*3)
	DM6553	0000	Unit No. 00

\*1 The RS-232C port of the Communication Board.

\*2 □□ is the set value of the communication speed. Set the communication speed to the same value as that of the NB Unit.

\*3 Standard settings of the Communication conditions are as follows:  
Start bit: 1 bit, Data bit: 7 bit, Stop bit: 2 bit, parity check: even



### Additional Information

When the NB Unit communicates with the C-Series via Host Link while the PLC is in the Run mode, the mode will be automatically switched to the Monitor mode. Make sure that there will be no problem with the actual system before using them.

● **Connection methods for CPM2C**

CPM2C only has a connector with the same shape of the CS-Series' peripheral port, but the signal cables inside are classified as used for the RS-232C port built in the CPU Unit and for the peripheral port. Therefore, when using CPM2C, differentiate between the settings for the RS-232C port built in the CPU and for the peripheral port based on the conversion cable and port employed to ensure correct use. Besides, when using a simple communication device (CPM2C-CIF21 type), connect to the RS-232C port. For details, refer to the *CPM2C Operation Manual (W356)*.

Use a self-made connection cable to connect the NB Unit and CPM2C. Connect to CPM2C's built-in RS-232C port instead of the peripheral port.

Port connected to the PT	PLC System Settings
CS1W-CN118 type port(D-Sub 9-pin)	Carry out settings for the built-in RS-232C port

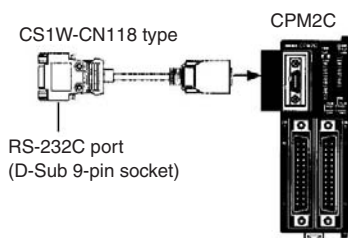

When using a simple communication device (CPM2C-CIF21 type), connect to the RS-232C port directly.

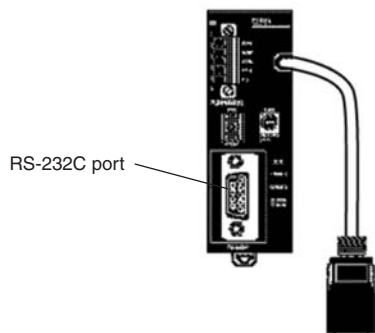

## ● Settings for the front-side DIP Switches

To activate the settings of [PLC System Settings Area] (Data memory), set as follows according to the PLC:

- For C200HX/HG/HE (-Z)

For C200HX/HG/HE(-Z)

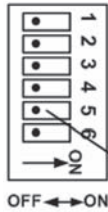

Communication condition setting for the RS-232C port.  
Set the DIP switch 5 to OFF, and activate the "settings" in PLC system settings.

- For CPM2C (Only the RS-232C port can be connected)

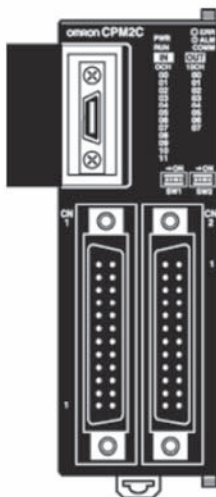

Carry out settings according to the using conditions of the peripheral port and built-in RS-232C port.

- When connecting the PT to the built-in RS-232C port (connect the device that needs to perform communications other than that within the standard setting range)



Set SW1 to OFF  
Set SW2 to ON

- When connecting the PT to the built-in RS-232C port (connect a programming console to the peripheral port)



Set SW1 to OFF  
Set SW2 to OFF

## When connecting to CS-Series CPU Units

For CS1G/H-CPU□□ (-V1) types and CS1G/H-CPU□□H types

### ● Connection Methods

Connect to the RS-232C port built in the CPU Unit or the RS-232C port of the communication board. When connecting to the peripheral port, a connection cable dedicated for the peripheral port is needed (CS1W-CN118 type).

Only RS-232C can be used for connection.

### ● PLC System Settings Area

When connecting to CS-Series CPU Unit, refer to the following table and set the communication conditions as follows in [PLC System Settings] based on the communication port in use.

Connection Methods	Channel No.	Write Value	Setting
Use the RS-232C port built in CS1G/H, CS1G/H-H	160	8000	Use Host Link
	161	0000~000A(*1)	Communication speed
	163	0000	Unit No. 00
Use the peripheral port of CS1G/H, CS1G/H-H	144	8000	Use Host Link
	145	0000~000A(*1)	Communication speed
	147	0000	Unit No. 00

\*1 The communication speed should be set to the same value as that of the NB Unit.

[PLC System Settings] can be directly set with a peripheral tool (programming console), or it can be set by transmitting the [PLC System Settings] set up by a peripheral tool (CX-Programmer) to the CPU Unit.

For details about the [PLC System Settings], refer to *SYSMAC CS Series Operation Manual (W339)*.

### ● Settings for the front-side Switches

Set the DIP switches 4 or 5 as follows according to the NB-S series port connected.

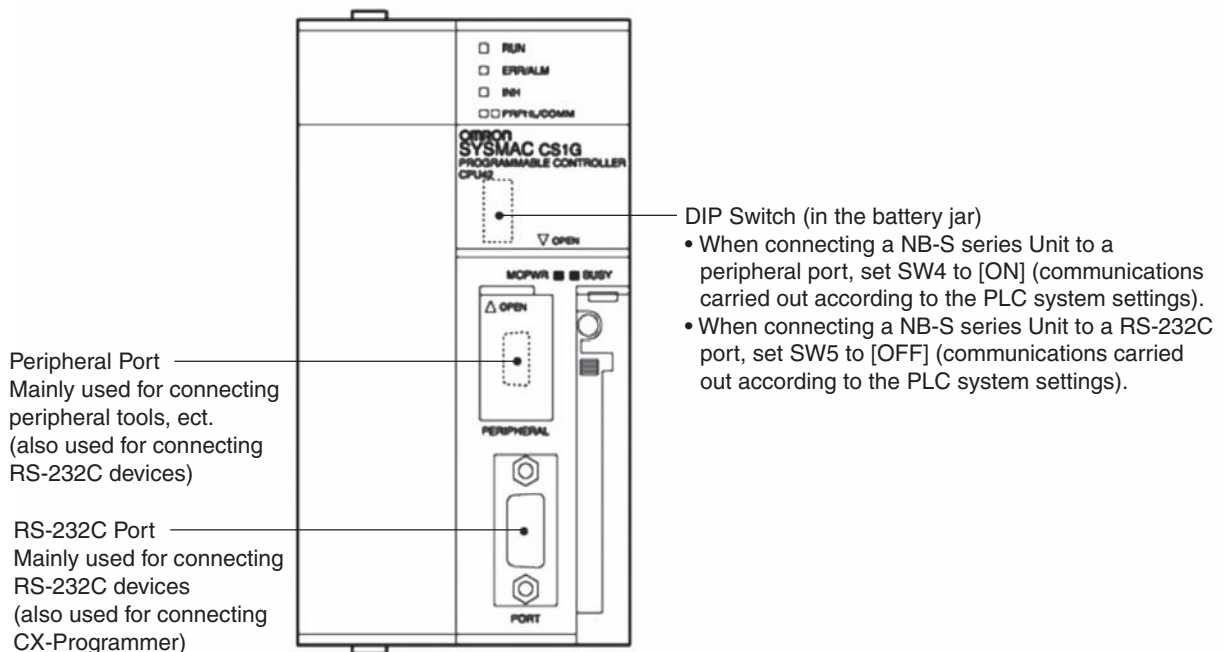

## When connecting to CJ Series CPU Units

For CJ1G-CPU□□ type, CJ1G/H-CPU□□H types and CJ1M-CPU□□ type

### ● Connection Methods

Connect to the RS-232C port built in the CPU Unit or the RS-232C port of the communication board. When connecting to the peripheral port, a connection cable dedicated for the peripheral port is needed (CS1W-CN118 type). Only RS-232C can be used for connection.

### ● PLC System Settings Area (for RS-232C)

When connecting to the CJ-Series CPU Unit, refer to the following table and set the communication conditions as follows in [PLC System Settings] based on the communication port in use.

Connection Methods	Channel No.	Write Value	Setting
Use the RS-232C port built in CJ1G-CPU□□ type, CJ1G/H-CPU□□H types, CJ1M-CPU□□ types	160	8000	Use Host Link
	161	0000~000A(*1)	Communication speed
	163	0000	Unit No. 00
Use the peripheral port of CJ1G-CPU□□ type, CJ1G/H-CPU□□H types, CJ1M-CPU□□ type	144	8000	Use Host Link
	145	0000~000A(*1)	Communication speed
	147	0000	Unit No. 00

\*1 The communication speed should be set to the same value as that of the NB Unit.

[PLC System Settings] can be directly set with a peripheral tool (Programming console), or it can be set by transmitting the [PLC System Settings] set up by a peripheral tool (CX-Programmer) to the CPU Unit.

For details about the [PLC System Settings], refer to *SYSMAC CJ Series Operation Manual (W393)*.

### ● Settings for the front-side Switches

Set the DIP switches 4 or 5 as follows according to the NB-S series port connected.

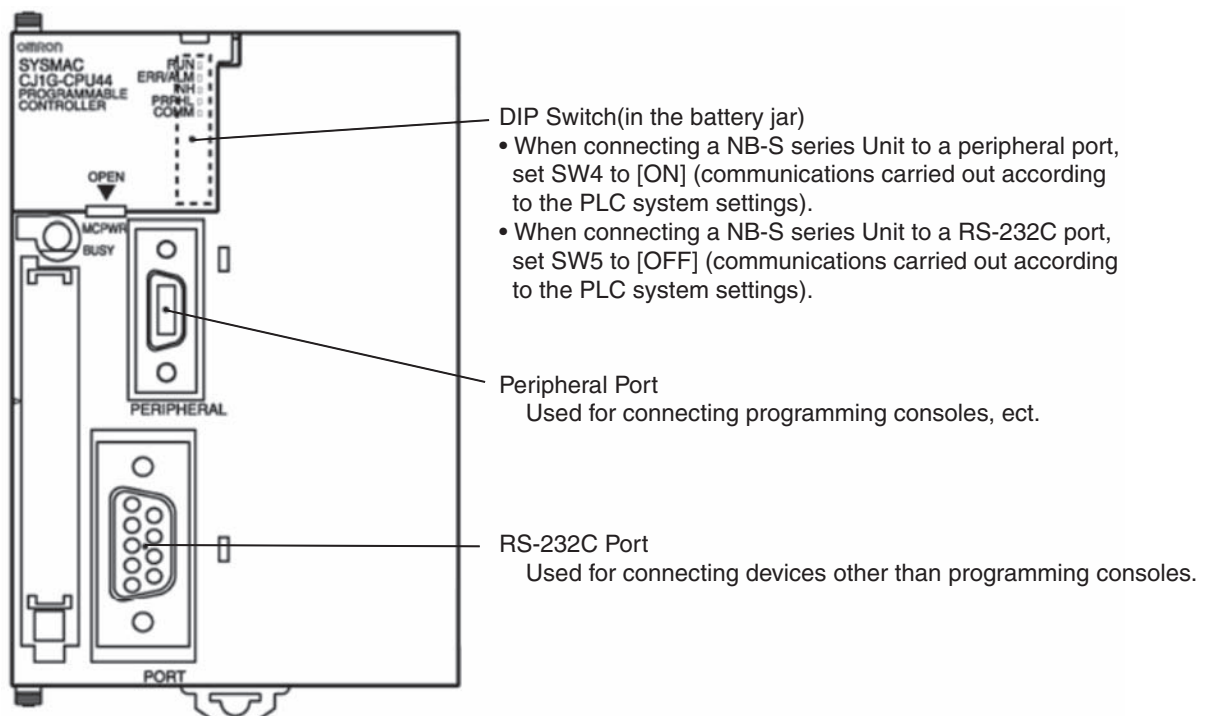

## When connecting to CJ2-Series CPU Units

For CJ2M-CPU3□ type, CJ2M-CPU1□ type and CJ2H-CPU6□(-EIP) type

### ● Connection Methods

Connect to the RS-232C port built in the CPU Unit or the RS-232C port of the communication board.

### ● PLC System Settings Area (for RS-232C)

Carry out setting by transmitting the [PLC System Settings] set up by a peripheral tool (CX-Programmer) to the CPU Unit. On the [Serial Port] options page of [PLC System Settings], set the connection mode to Host Link: 7 Data Bits, 2 Stop Bits, Even. And set the communication speed to the same as that of the NB Unit.

For details about the [PLC System Settings], refer to *SYSMAC CJ2 Series Software User's Manual* (W473).

### ● Settings for the front-side Switches

Set the DIP switch 5 of the CPU Unit as follows according to the NB-S series port connected.

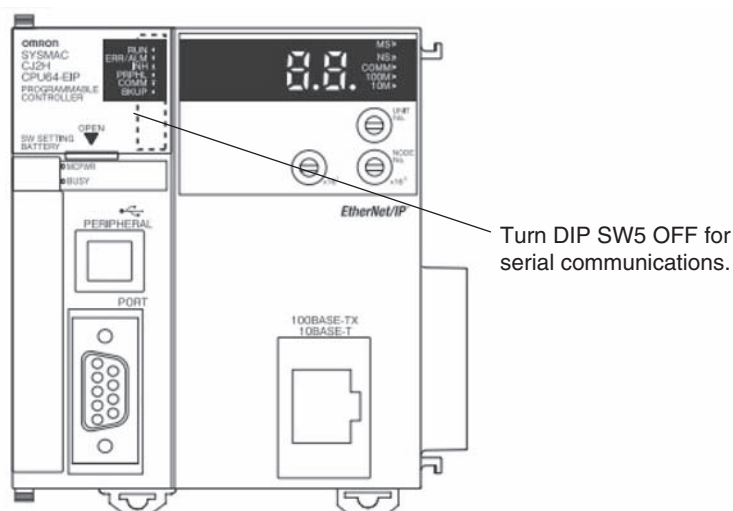

## When connecting to a CS-Series Serial Communication Board

For CS1W-SCB21 type (Both of port 1 and 2 are RS-232C ports)

For CS1W-SCB41 type (Port 1 is RS-232C port)

### ● Settings for the DM Fixed Allocation Area of the CPU Unit

Write settings directly to the [DM Fixed Allocation Area] of the CPU Unit (System Settings Area) with a peripheral tool (programming console or CX-Programmer). After finishing the write-in, the settings can be activated through any of the methods of reconnecting the power supply, restarting the Unit, reactivating the communication port, executing the STUP instruction.

The followings are the Channel Nos. and settings of the DM Fixed Allocation Area.

It is the same when using RS-232C.

DM Fixed Allocation Area (CH)	Write Value	Setting
Port 1		
DM32000	8000	Use Host Link
DM32001	0000~000A (*1)	Communication speed
DM32003	0000	Unit No. 00

\*1 The communication speed should be set to the same value as that of the NB Unit.

## When connecting to a CS-Series Serial Communication Unit

For CS1W-SCU21 type (Both of port 1 and 2 are RS-232C ports)

### ● Settings for the DM Fixed Allocation Area of the CPU Unit

Write settings directly to the [DM Fixed Allocation Area] of the CPU Unit (System Settings Area) with a peripheral tool (programming console or CX-Programmer). After finishing the write-in, the settings can be activated through any of the methods of reconnecting the power supply, restarting the Unit, reactivating the communication port, executing the STUP instruction.

The followings are the Channel Nos. and settings of the DM Fixed Allocation Area.

$m = \text{DM30000} + 100 \times \text{Unit No. (CH)}$

DM Fixed Allocation Area (CH)		Write Value	Setting
Port 1	Port 2		
m	m+10	8000	Use Host Link
m+1	m+11	0000~000A (*1)	Communication speed
m+3	m+13	0000	Unit No. 00

\*1 The communication speed should be set to the same value as that of the NB Unit.

### ● Settings for the front-side Switches (Take CS1W-SCU21 as an example)

Set the Unit No. of the serial communication Unit by the rotary switch on the front side of the Unit. Use a straight screwdriver set the switches as follows to display the numbers and symbols shown in the table.

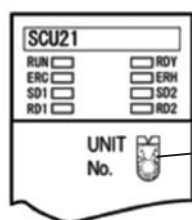

- Unit number settings  
Set it to [0] ~ [F] in order to avoid duplicating other Units.



## When connecting to a CJ Series Serial Communication Unit

For CJ1W-SCU21/22 type (Both of port 1 and 2 are RS-232C ports)

For CJ1W-SCU41/42 type (Port 2 is RS-232C port)

### ● Settings for the DM Fixed Allocation Area of the CPU Unit

Write settings directly to the [DM Fixed Allocation Area] of the CPU Unit (System Settings Area) with a peripheral tool (programming console or CX-Programmer). After finishing the write-in, the settings can be activated through any of the methods of reconnecting the power supply, restarting the Unit, reactivating the communication port, executing the STUP instruction.

The followings are the Channel Nos. and settings of the DM Fixed Allocation Area.

It is the same when using RS-232C.

$m = \text{DM30000} + 100 \times \text{Unit No. (CH)}$

DM Fixed Allocation Area (CH)		Write Value	Setting
Port 1	Port 2		
m	m+10	8000	Use Host Link
m+1	m+11	0000~000A (*1)	Communication speed
m+3	m+13	0000	Unit No. 00

\*1 The communication speed should be set to the same value as that of the NB Unit.

### ● Settings for the NJ Series

Set the Serial Communication Unit configuration below with peripheral tool (Sysmac Studio). Under Configurations and Setup - CPU/Expansion Racks in the Multiview Explore, settings are existed.

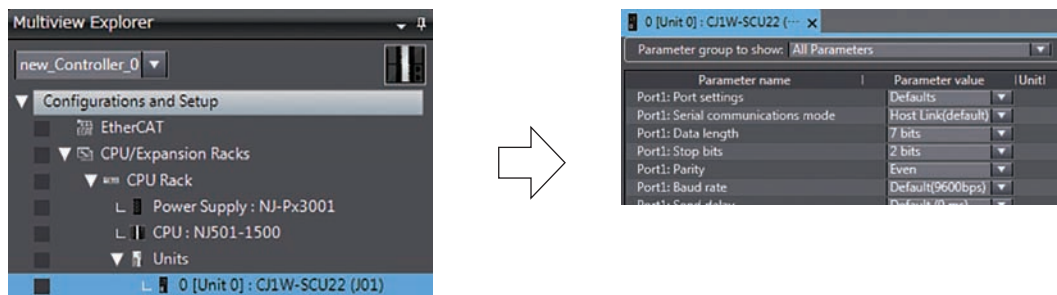

In the Serial Communication Unit settings, configure the following settings:

Item	Set value
Serial communications mode	Host Link (FINS)
Unit No.	0
Baud rate	Set this to match the setting on the NB-series Unit.
Data length	7 bits
Parity	Even
Stop bit	2 bits

● Settings for the front-side Switches (Take CJ1W-SCU41 as an example)

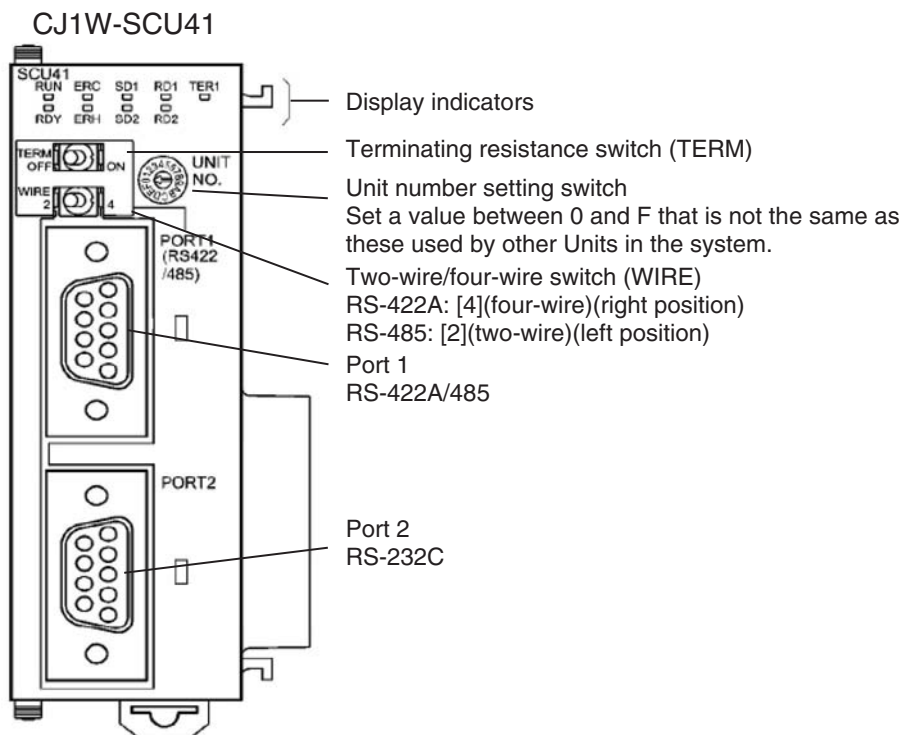

## When connecting to a NX Serial Communication Board

For NX1W-CIF01 (RS-232C)

### ● Setting for the CPU Unit

Set the CPU Unit configuration below with peripheral tool (Sysmac Studio).

### ● Configuration and Option Board Serial Communications Settings

Configure these settings in the Option Board Settings Tab Page, which is displayed by selecting **Option Board Settings** under **Configurations and Setup - Controller Setup**.

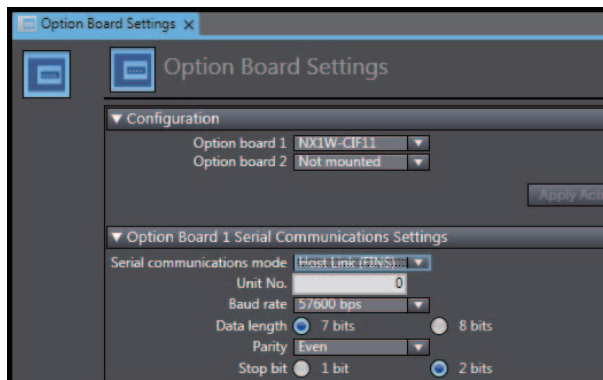

Under **Configuration**, specify the models of the Option Boards to use.

Under **Option Board Settings**, configure the following settings:

Item	Set value
Serial communications mode	Host Link (FINS)
Unit No.	0
Baud rate	Set this to match the setting on the NB-series Unit.
Data length	7 bits
Parity	Even
Stop bit	2 bits

### ● Memory Settings for CJ-series Units

Specify the memory used for CJ-series Units in the Memory Settings for CJ-series Units Tab Page, which is displayed by selecting **Memory Settings** under **Configurations and Setup - Controller Setup**.

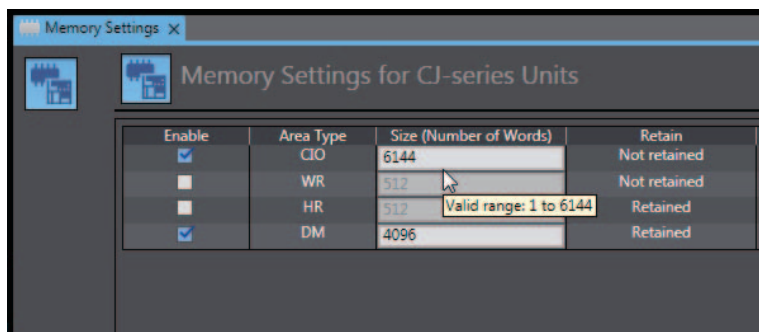

Set the area type and the number of words of memory enough to include the memory that will be used for the screen data to create.



#### **Precautions for Correct Use**

Create screen data to avoid using the EM area because the NX1P2 CPU Unit does not support the EM area type.

## 2-5 UDP Communication Connection

This section describes how to connect the PT with the Host through the UDP protocol.

**Note** Both OMRON CJ/CS/NJ/NX Series Ethernet UDP and OMRON CP Series Ethernet UDP communication protocols are UDP protocol. The difference between these two protocols is only in the address range of the channel.

When using OMRON Ethernet UDP communication protocol, EM4 bank or higher cannot be accessed at bit level.

### 2-5-1 Connecting to Host Via Ethernet

To connect to the network using Ethernet, the network number, node number, and IP address must be set. Use the NB-Designer to set the settings. (The default IP address of PT Unit is 192.168.250.1.)

#### ● Connecting PT Directly to the Host

Connect the NB to the host using twisted-pair cable.

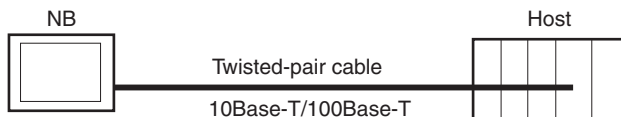

#### ● Connecting PT to Host with a Hub

Multiple NBs and hosts can be connected using twisted-pair cable and a hub.

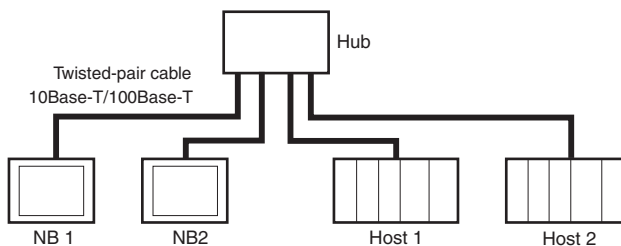

- **The UDP communication for NB / NB-S series products is only limited the local network, but the Ethernet communication crossing the network segment is allowable with the prerequisite of using the router. That's to say, the supported network is only limited to the local network, but the various devices in the network can cross the network segment. Please take the following architecture as reference.**

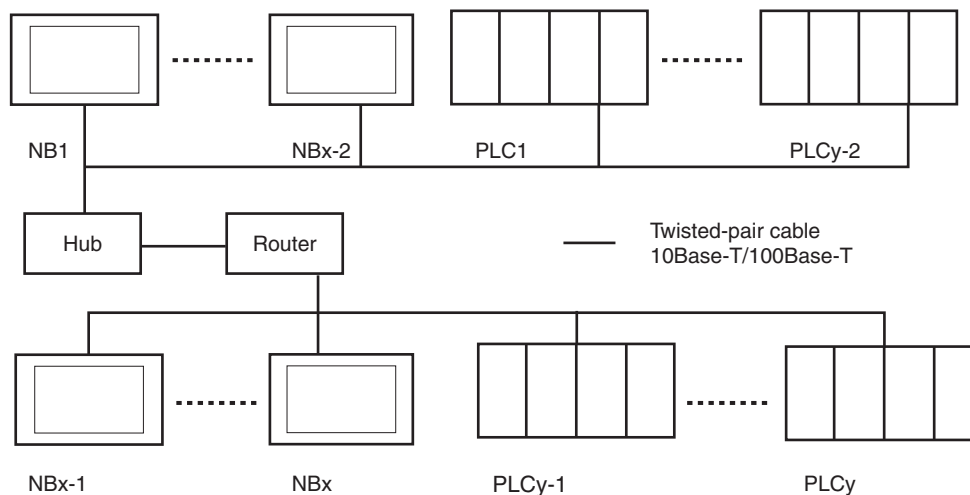

X represents the amount of NB / NB-S series products, and y represents the amount of PLC. The relationship between x and y must meet the following conditions:

- $x = 1$
- $y \geq 1$
- $x + y \leq 33$

In this system architecture, the system has only one network number. And the unique ID, i.e. Node ID, is assigned to both NB / NB-S and PLC in the system.

When the actual amount of configured devices (NB / NB-S series products + PLC) is greater than 33, or add another NB, the customer can create a new NB-Designer project to handle this problem.



**Additional Information**

UDP communication via Ethernet is convenient as it allows free access to hosts on the network. In cases where there are many hosts and NB Units connected on a single network, however, response speed of a host may be lowered due to excessive access to the particular host or NB Unit, subsequently leading to possible lowered response speed of the NB Unit which refers to values in the host. Thus, when making a system, please examine the load of the maximum configuration, and design and test the system while fully considering performance.

● **Recommended Network Configuration Devices**

The following products are recommended for configuring the network when an Ethernet Unit is used.

Part	Maker	Model number	Specifications	Inquires
Hub	100BASE-TX			
	OMRON	W4S1-03B	10/100 Mbit/s 3-port switching hub	
	OMRON	W4S1-05B(C)	10/100 Mbit/s 5-port switching hub	
	Phoenix Contact	SWITCH5TX	10/100 Mbit/s 5-port switching hub	
Twisted-pair cable	100BASE-TX			
	Fujikura	CTP-LAN50.5mm x 4P	UTP (unshielded twisted-pair) cable: Category 5, 5e	
	10BASE-T			
	Fujikura	CTP-LAN50.5mm x 4P	UTP (unshielded twisted-pair) cable: Category 3, 4, 5, 5e	
Connectors (Modular plug)	UTP Plug			
	Panduit Corp	MP588-C	---	

## Precautions on Laying Twisted-pair Cable

### ● Basic Precautions

- Push the cable connector until it clicks into the place both the PLC and the hub.
- After laying the twisted-pair cable, check the connection with a 10Base-T cable tester.

### ● Environment Precautions

- The UTP cable is not shielded. Also, hub is created for use under OA environment. Construct a system using a hub suitable for use under FA environment in locations subject to noise.
- Do not lay the twisted-pair cable together with high-voltage lines.
- Do not lay the twisted-pair cable near devices that generate noise.
- Do not lay the twisted-pair cable in locations subject to high temperature or high humidity.
- Do not lay the twisted-pair cable in locations subject to excessive dirt and dust or to oil mist or other contaminants.

### ● Hub Installation Environment Precautions

- Do not install the hub near devices that generate noise.
- Do not install the hub in locations subject to high temperature or high humidity.
- Do not install the hub in locations subject to excessive dirt and dust or to oil mist or other contaminants.

## Connecting the Cable

**Note 1** Turn OFF the PLC's power supply before connection or disconnecting twisted-pair cable.

- 2 Allow enough space for the bending radius of the twisted-pair cable.

**1** Lay the twisted-pair cable.

**2** Connect the cable to the hub. Be sure to press in the cable until it locks into place.  
Request cable installation from a qualified professional.

**3** Connect the cable to the connector on the PLC. Be sure to press in the cable until it locks into place.

## 2-5-2 Parameter Settings for UDP at NB Side

After placing the desired PT and PLC into Configuration and Setup Window, select [Communication Setting] in the [Option] menu, and then click the “Add” button after the “Communication Setting” dialog box pops up.

After selecting the Device Type and the related UDP protocol, you can make settings of IP Address, Node ID and Network No. and etc. for the PT.

The screenshot shows the 'Communication Setting' dialog box with the following settings:

- Device Type:  PT  PLC
- Device No.: HM10
- IP Address: 192 . 168 . 250 . 1
- Port No.: 9600
- Comm Protocol: OMRON CJ/CS/NJ S
- Node ID: 1
- Network No.:  Default (0:CP1E)  User Defined 0

The 'PLC Communication Setting' panel on the right contains the following parameters:

PLC Communication Type	UDP
PLC Communication Time Out(s)	1
Protocol Time Out 1(ms)	1
Protocol Time Out 2(ms)	1
Max interval of word block pack	16
Max interval of bit block pack	16
Max size of word block package	32
Max size of bit block package	16

Buttons: Use Default Setting, OK, Cancel

**Note** When there is CP1E PLC in the UDP network architecture, the Network No. should be 0. Otherwise, the communications through the UDP protocol between the NB and CP1E in this architecture will be impossible.

The settings of IP Address, Node ID and related communication parameters for PLC can be made.

The screenshot shows the 'Communication Setting' dialog box with the following settings:

- Device Type:  PT  PLC
- Device No.: PLC0
- IP Address: 192 . 168 . 250 . 2
- Port No.: 9600
- Comm Protocol: OMRON CJ/CS/NJ S
- Node ID: 2

The 'PLC Communication Setting' panel on the right contains the following parameters:

PLC Communication Type	UDP
PLC Communication Time Out(s)	1
Protocol Time Out 1(ms)	1
Protocol Time Out 2(ms)	1
Max interval of word block pack	16
Max interval of bit block pack	16
Max size of word block package	32
Max size of bit block package	16

Buttons: Use Default Setting, OK, Cancel

**Note** The settings of communication parameters should be the same as that of the actual PLC.



Take the communication between single PT and the PLC of Omron CJ2M-CPU33 (hereinafter abbreviated as “PLC0”) as example:

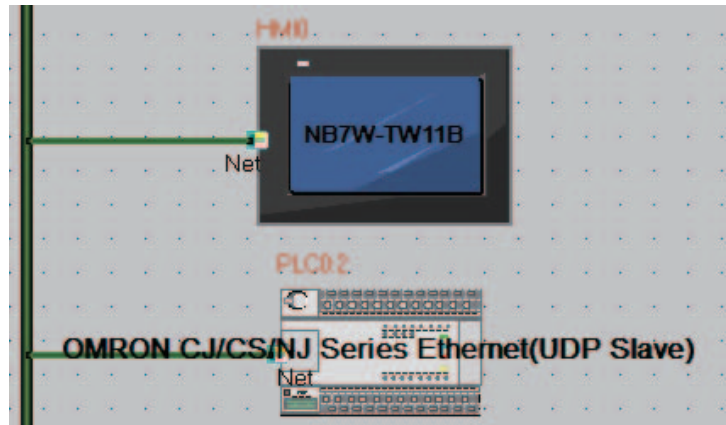

Configure the devices and set the communication parameters in the Configuration and Setup Window, then click [Add] in [PT Property] - [PT] - [Communication Setting] to set parameters for PT network-interface communication.

### ● PT settings (example)

Device Type	Device No.	IP Address	Port Number	Communication Protocol	Mater/Slave	Station No. / Node Number
PT	HMI0	192.168.250.1	9600	OMRON CJ/CS/NJ Series Ethernet UDP	M(Master)	1
PLC	PLC0	192.168.250.2	9600	OMRON CJ/CS/NJ Series Ethernet (UDP Slave)	S(Slave)	2

Please note that the IP address set here should be same as the actual IP address of PLC during the configuration. The result is shown as below:

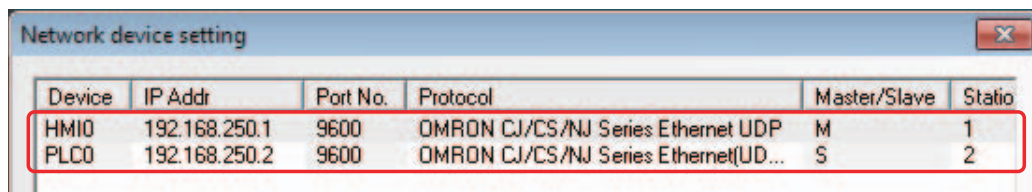

### ● PT settings for connection with 2 and more types of hosts (example)

Device Type	Device No.	IP Address	Port Number	Communication Protocol	Mater/Slave	Station No. / Node Number
PT	HMI0	192.168.250.1	9600	OMRON CP Series Ethernet UDP	M(Master)	1
PT	HMI0	192.168.250.1	9600	OMRON NX1 Series Ethernet UDP	M(Master)	1
PLC	PLC0	192.168.250.2	9600	OMRON CP Series Ethernet(UDP Slave)	S(Slave)	2
PLC	PLC1	192.168.250.3	9600	OMRON NX1 Series Ethernet(UDP Slave)	S(Slave)	3

When you connect 2 or more types of PLCs with the NB, register them according to their protocols respectively even though you use one PT. The result is shown below.

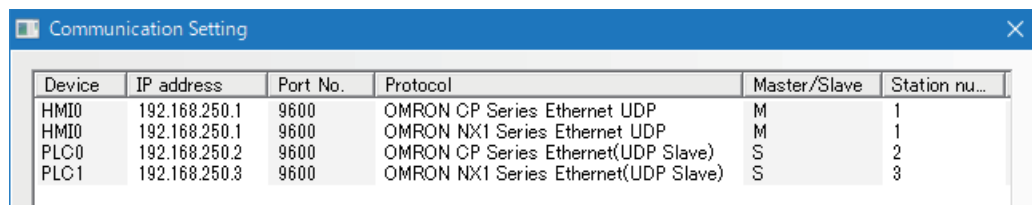

### 2-5-3 Host Types and Settings of Ethernet Unit

Units that are used for Ethernet communications vary according to the type and series of OMRON PLC used.

When connecting an Ethernet Unit, check the series and type of the PLC that it will be connected to and the model of the Unit that is mounted to the PLC.

Connecting the Controllers and NB-S series Units by the combinations in the table below.

Series name	Using the built-in board	Using an Ethernet Unit	Ethernet Unit
CS Series	—	CS1G/H-CPU□□(-V1)	CS1W-ETN21
		CS1G/H-CPU□□H	
		CS1D-CPU□□H	CS1W-ETN21
CJ Series	—	CJ1G/H-CPU□□H	CJ1W-ETN21
		CJ1M-CPU□□(-ETN)	
	CJ1M-CPU□□-ETN	—	
	—	CJ2H-CPU□□(-EIP)	CJ1W-ETN21
CJ2M-CPU□□			
CP1H Series	—	CP1H-Y	CJ1W-ETN21
		CP1H-XA	CP1W-CIF41
		CP1H-X	
CP1L Series	—	CP1L-L14/20	CP1W-CIF41
		CP1L-M30/40/60	
	CP1L-EL20	—	
CP1E Series	—	CP1E-N30/40/60	CP1W-CIF41
		CP1E-NA20	
CP2E Series	CP2E-N14/20/30/40/60	—	—

For details on the hosts that can be connected to NB-S series PTs via the Ethernet, refer to *A-4 List of Models in PT Setup*.

#### ● Host Settings

The types of hosts that can be connected to NB-S series PTs with the Ethernet and the host settings are as follows. The following settings must be set at the host.

Item	Host Settings
Number of nodes	33 (See note 1)
Network number	0 to 127 (See note 2)
UDP port number	1024 to 65535, default is 9600.
IP address	0.0.0.0 to 255.255.255.255
Subnet mask	0.0.0.0 to 255.255.255.255
Default gateway	0.0.0.0 to 255.255.255.255
Node number	0 to 254 (See note 3)

**Note 1** The max total number of registered nodes by NB-Designer in the network is 33, at least 1 NB-S series PT and 1 host included.

**2** If there is CP1E PLC in the actual network architecture, the Network No. must be set to 0.

**3** The Node ID of 0 is equivalent to that of 1 (default).

For the limitations to the Host parameters' setting, refer to *2-5-5 Parameter Settings at Host Side (CX-Programmer)* in *PT Setup*.

## IP Address Configuration

The IP address is comprised of 32 bits of binary data, consisting of the net ID and host ID. The net ID is the address that identifies the network, and the host ID is the ID that identifies the host (node).

The IP address is divided into class A, B, and C. Select the address system from among the classes according to the network configuration.

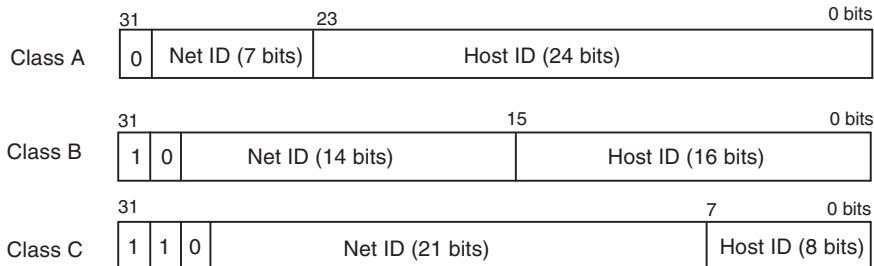

The number of networks and hosts that can be identified depends on the class used.

Class	Network scope	Number of hosts
Class A	Small	$2^{24} - 2$ max. (16,777,214 max.)
Class B	Medium	$2^{16} - 2$ max. (65,534 max.)
Class C	Large	$2^8 - 2$ max. (254 max.)

The IP address is a 32-bit value divided into four 8-bit fields. Each octet is expressed as a decimal and is separated by a period.

Example: 10000010 00111010 00010001 00100000 → 130.58.17.32



### Additional Information

- Set the same net ID for all nodes in the same network.
- The net ID of the IP address is the value that identifies the Ethernet network (IP network segment). The net ID is not the same as the network address used for FINS communications.
- The IP network segment is the logical network unit that is configured by the nodes that have the same net ID.

## IP Address Allocation

The IP addresses are allocated so that they are unique for each node in the network (or between two or more networks). If two or more nodes are allocated the same IP address, the remote nodes with the same IP address will also malfunction.

IP (Internet Protocol) is a communications protocol that conforms to international standards. Therefore, to connect to the Internet, always obtain IP addresses that have been allocated by a public organization (i.e., the NIC in the country of use, such as the JPNIC in Japan). Using IP addresses that are not recognized by the NIC (JPNIC) to connect to the Internet could have unforeseen social consequences, such as causing the networks of another organizations to malfunction unexpectedly.

## Local IP Address

The local IP address indicates the IP address of the Ethernet Unit that is used to set the settings.

The following IP address settings are not possible.

Net ID with all bits set to 0 or 1.

Host ID with all bits set to 0 or 1.

Subnet ID with all bits set to 1.

IP addresses that begin with 127 (7F Hex) (e.g., 127.35.21.16).

## Subnet Mask

When more than one node is connected to the network, network operation and management can be difficult. Therefore, for convenience, configure the system by dividing a single network into multiple sub-networks. The system operates internally as multiple networks, but externally appears as a single network.

To operate a system in this way, divide the host ID field of the IP address into a subnet ID field and a host ID field.

The subnet ID field is identified by the information in the subnet mask. The subnet mask is a bit mask in which the net ID and subnet ID fields are 1 and the host ID field is 0.

Example: 11111111 11111111 11111111 00000000 → FFFFFFF0

The subnet mask must have a value that is common to all nodes on the same sub-network.

Setting the subnet mask is not required if sub-networks are not used. The system recognizes subnet masks without a subnet ID field (i.e., subnet masks with net ID and host ID fields only).

The methods for setting each Unit are described next.

## CS-series PLCs

**Note 1** Always turn OFF the power to the PLC before setting the rotary switches.

**2** Create I/O tables for the CPU Unit when setting the unit number for the first time or changing settings.

CS-series Ethernet Units:

CS1W-ETN21

### ● Setting the Front Panel Switches

#### Setting Unit Numbers

Always set the unit numbers so that the unit numbers of other CPU Bus Units mounted to the CPU Unit are all unique.

Use a small screwdriver to set the rotary switches, being careful not to damage them.

The factory setting is 0.



Setting range
0 to F

## Setting Node Numbers

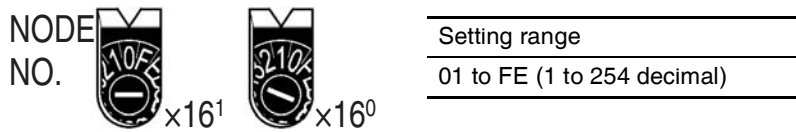

Set the upper digit using the left rotary switch and the lower digit using the right rotary switch.

The factory setting is 01. The Node ID of the rotary switch here must be consistent with that of PLC in the “Communication Setting” dialog box for the actual project created in the NB-Designer.

### ● Setting Local IP Addresses

For CS-series Ethernet Units, set the local IP address from the CX-Programmer or other Support Software for the CPU Unit. Refer to the SYSMAC CS/CJ Series Ethernet Unit Operation Manual (Cat. No. W420) for details on setting methods.

### ● Ethernet Connectors

CS1W-ETN21

This is the connector used to connect the twisted-pair cable to the Ethernet.

- Electrical characteristics: Conforms to IEEE802.3 standards.
- Connector structure: RJ45 8-pin modular connector (conforms to ISO8877).

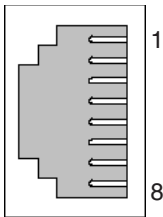

Connector Pin	Signal name	Abbreviation	Signal direction
1	Send data +	TD+	Output
2	Send data -	TD-	Output
3	Receive data +	RD+	Input
4	Not used.	-	-
5	Not used.	-	-
6	Receive data -	RD-	Input
7	Not used.	-	-
8	Not used.	-	-

## CJ-series PLCs

**Note 1** Always turn OFF the power to the PLC before setting the rotary switches.

**2** Create I/O tables for the CPU Unit when setting the unit number for the first time or changing settings.

CJ-series Ethernet Units:

CJ1W-ETN21

### ● Setting the Front Panel Switches

#### Setting Unit Numbers

Always set the unit numbers so that the unit numbers of other CPU Bus Units mounted to the same CPU Unit are all unique.

Use a small screwdriver to set the rotary switches, being careful not to damage them.

The factory setting is 0.

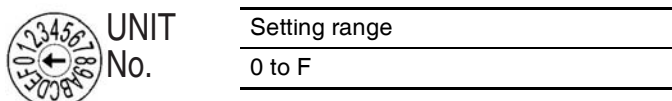

## Setting Node Numbers

Set the node numbers as hexadecimal values with the node number setting switch. Always set the node numbers so that other Ethernet Units connected to the same Ethernet network all have unique addresses. As long as the addresses are unique, they can be set between 01 and FE (1 to 254 decimal).

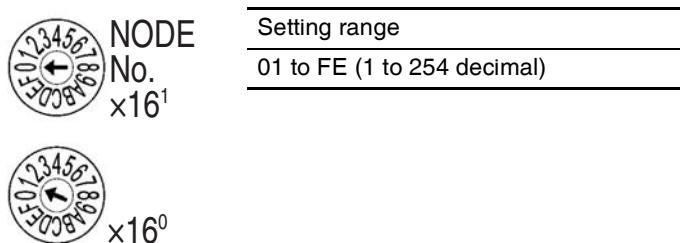

Set the upper digit using the top rotary switch and the lower digit using the bottom rotary switch. The factory setting is 01.

### ● Setting Local IP Addresses

For CJ-series Ethernet Units, set the local IP address from the CX-Programmer or other Support Software for the CPU Unit. Refer to the SYSMAC CS/CJ Series Ethernet Unit Operation Manual (Cat. No. W420) for details on setting methods.

### ● Ethernet Connectors

CJ1W-ETN21

This is the connector used to connect the twisted-pair cable to the Ethernet.

- Electrical Characteristics: Conforms to IEEE802.3 standards.
- Connector Layout: RJ45 8-pin modular connector (conforms to ISO8877).



#### Additional Information

- CX-Programmer version 8.1 or higher is required when CP1W-CIF41 is used.

## CP-series PLCs

CP-series Ethernet Option Board

CP1W-CIF41

### ● Setting Node Numbers

Set the node number to a unique value. Do not set it to the same value as any other Ethernet node on the same Ethernet network. Refer to the following manuals for the setting procedures.

CP1H: SYSMAC CP Series CP1H CPU Unit Operation Manual (Cat. No. W450)

CP1L: SYSMAC CP Series CP1L CPU Unit Operation Manual (Cat. No. W462)

CP1E: SYSMAC CP Series CP1E CPU Unit Software User's Manual (Cat. No. W480)

### ● Setting Local IP Addresses

Use a Web browser to set the local IP address of the CP-series Ethernet Option/Built-in Board. Refer to the following manuals for the setting procedures.

CP1H: SYSMAC CP Series CP1H CPU Unit Operation Manual (Cat. No. W450)

CP1L: SYSMAC CP Series CP1L CPU Unit Operation Manual (Cat. No. W462)

CP1E: SYSMAC CP Series CP1E CPU Unit Software User's Manual (Cat. No. W480)

### ● Ethernet Connector

CP1W-CIF41

This is the connector used to connect the twisted-pair cable to the Ethernet.

- Electrical Characteristics: Conform to the IEEE 802.3 standard.
- Connector Layout: RJ45 8-pin modular connector (conforms to ISO8877.)

## CP1L-EL/EM

### ● Setting Node Numbers

Set the node number to a unique value from the CX-Programmer or other Support Software. Do not set it to the same value as any other Ethernet node on the same Ethernet network. Refer to the following manuals for the setting procedures.

CP1L-EL/EM: SYSMAC CP Series CP1L-EL/EM CPU Unit Operation Manual (Cat. No. W516)

### ● Setting Local IP Addresses

Set the local IP address from the CX-Programmer or other Support Software for the CP1L-EL/EM series CPU Unit. Refer to the following manuals for the setting procedures.

CP1L-EL/EM: SYSMAC CP Series CP1L-EL/EM CPU Unit Operation Manual (Cat. No. W516)

### ● Ethernet Connector

CP1L-ETN21

This is the connector used to connect the twisted-pair cable to the Ethernet.

- Electrical Characteristics: Conform to the IEEE 802.3 standard.
- Connector Layout: RJ45 8-pin modular connector (conforms to ISO8877.)

## CP2E-N

### ● Setting Node Numbers

Set the node number to a unique value from the CX-Programmer or other Support Software. Do not set it to the same value as any other Ethernet node on the same Ethernet network. Refer to the following manuals for the setting procedures.

CP2E-N: SYSMAC CP Series CP2E CPU Unit Software USER'S MANUAL (Cat. No. W614)

### ● Setting Local IP Addresses

Set the local IP address from the CX-Programmer or other Support Software for the CP2E-N series CPU Unit. Refer to the following manuals for the setting procedures.

CP2E-N: SYSMAC CP Series CP2E CPU Unit Software USER'S MANUAL (Cat. No. W614)

### ● Ethernet Connector

CP2E-N14/N20/N30/N40/N60 Built-in Ethernet Port

This is the connector used to connect the twisted-pair cable to the Ethernet.

- Electrical Characteristics: Conform to the IEEE 802.3 standard.
- Connector Layout: RJ45 8-pin modular connector (conforms to ISO8877.)

## 2-5-4 Host Types and Settings of Ethernet/IP Unit

NB-series enables communication with a controller via the Ethernet using built-in ports of the controller or EtherNet/IP Unit.

Units that are used for communications vary according to the type and series of OMRON PLC used.

When connecting an Ethernet/IP Unit, check the series and type of the PLC that it will be connected to and the model of the Unit that is mounted to the PLC.

NB-S series PTs and the following Controllers can be connected with Ethernet/IP units.

Series name	Using the built-in board	Using an EtherNet/IP Unit	EtherNet/IP Unit
CS Series	—	CS1G/H-CPU□□(-V1) CS1G/H-CPU□□H CS1D-CPU□□H	CS1W-EIP21
CJ Series	—	CJ1G/H-CPU□□H CJ1M-CPU□□(-ETN)	CJ1W-EIP21
	CJ2H-CPU□□-EIP	—	—
	CJ2M-CPU3□	—	—
	—	CJ2H-CPU□□(-EIP) CJ2M-CPU□□	CJ1W-EIP21
CP Series	—	CP1H	CJ1W-EIP21
NJ Series	NJ501 NJ301 NJ101	—	—
NX Series	NX102 NX1P2	—	—

**Note 1** Ethernet/IP Unit: Unit version 2.1 or later, the CJ2H-CPU□□-EIP and CJ2M-CPU3□ CPU Units have a built-in Ethernet connector.

**2** Use Port 2 to communicate via a built-in EtherNet/IP port of NX102.

For details on the hosts that can be connected to NB-S series PTs via the Ethernet/IP, refer to *A-4 List of Models* in *PT Setup*.

Refer to the following manual for host parameter settings:

SYSMAC CS/CJ-series Ethernet/IP Units Operation Manual (Cat. No. W465),

SYSMAC CJ-series CJ2 CPU Units Operation Manual (Cat. No. W472).

For the limitations to the Host parameters' setting, refer to *2-5-5 Parameter Settings at Host Side (CX-Programmer)* in *PT Setup*.

Refer to the following manual for the setting methods of each parameter, when connecting an NJ/NX-series CPU Unit:

NJ/NX Series CPU Unit Built-in EtherNet/IP Port User's Manual (Cat. No. W506)

There are limitations on the parameters' setting. Refer to *2-5-6 Parameter Settings at Host Side (Sysmac Studio)* in *PT Setup* for details.



## Connecting to a CJ-series CPU Unit

**Note 1** Always turn OFF the power to the PLC before setting the rotary switches.

2 Create I/O tables for the CPU Unit when setting the unit number for the first time or changing settings.

CJ-series CPU Unit (Built-in EtherNet/IP Port):

CJ2H-CPU□□-EIP

CJ2M-CPU3□

### ● Setting Local IP Addresses

Set the local IP address with the CX-Programmer or other Support Software.

Refer to the *SYSMAC CS/CJ Series Ethernet/IP Units Operation Manual* (Cat. No. W465) for details on setting methods.

### ● Setting the Front Panel Switches

#### Setting the Unit Numbers

Set a unique unit number for the CJ2 CPU Unit built-in Ethernet/IP port. The same unit number cannot be used by any other CPU Bus Unit connected to the CJ2 CPU Unit.

Use a small screwdriver to make the setting, and be sure not to damage the rotary switch. The unit number is factory-set to 0.

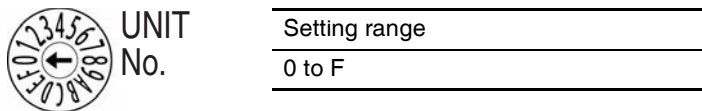

#### Setting Node Numbers

Set a node address for the built-in Ethernet/IP port. With the OMRON CJ/CS/NJ/CP UDP drive communications service, multiple Ethernet/IP Units (including the CJ2 Unit built-in Ethernet/IP port) connected by Ethernet are identified by their node addresses. Using the node address switches, set a unique node address in hexadecimal. The same node address cannot be used by any other Ethernet/IP Unit or Ethernet Unit connected on the same Ethernet network.

As long as it does not duplicate any other address, the node address can be set from 01 to FE (1 to 254 in decimal).

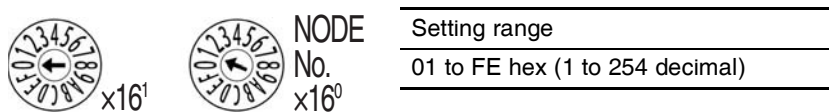

**Note** The node address is factory-set to 01. With the default setting, the values set on these switches become the last two digits of the built-in Ethernet/IP port's IP address.

The default IP address is 192.168.250.node\_address. With the factory-set node address of 01, the default IP address is 192.168.250.1.

The Node ID of the rotary switch here must be consistent with that of PLC in the "Communication Setting" dialog box for the actual project created in the NB-Designer.

● **Ethernet Connectors**

This is the connector used to connect the twisted-pair cable to the Ethernet.

- Electrical Characteristics: Conforms to IEEE802.3 standards.
- Connector Layout: RJ45 8-pin modular connector (conforms to ISO 8877).

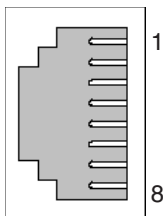

Connector Pin	Signal name	Abbreviation	Signal direction
1	Send data +	TD+	Output
2	Send data -	TD-	Output
3	Receive data +	RD+	Input
4	Not used.	-	-
5	Not used.	-	-
6	Receive data -	RD-	Input
7	Not used.	-	-
8	Not used.	-	-

**Connecting to a NJ/NX-series CPU Unit**

NJ-series CPU Unit (Built-in EtherNet/IP Port)

NJ501

NJ301

NJ101

NX-series CPU Unit (Built-in EtherNet/IP Port)

NX102 \*1

NX1P2

\*1 Use Port 2 to communicate via a built-in EtherNet/IP port of NX102.

● **Setting IP Addresses**

Set the IP address of the NJ/NX unit with the Sysmac Studio.

Refer to the Sysmac Studio Version 1 Operation Manual (Cat. No. W504) and the NJ/NX-series CPU Unit Built-in EtherNet/IP Port User's Manual (Cat. No. W501) for details on setting methods.

● **Ethernet Connectors**

This is the connector used to connect the twisted-pair cable to the Ethernet.

- Electrical Characteristics: Conforms to IEEE802.3 standards.
- Connector Layout: RJ45 8-pin modular connector (conforms to ISO 8877).

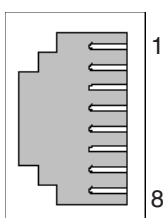

Connector Pin	Signal name	Abbreviation	Signal direction
1	Send data	TD+	Output
2	Send data -	TD-	Output
3	Receive data +	RD+	Input
4	Not used.	-	-
5	Not used.	-	-
6	Receive data -	RD-	Input
7	Not used.	-	-
8	Not used.	-	-

- Memory Settings for CJ-series Units  
Refer to the description of "When connecting to a NX Serial Communication Board" in *2-4-3 Settings for each Unit*.

## Connecting to a CS-series Ethernet/IP Unit

**Note 1** Always turn OFF the power to the PLC before setting the rotary switches.

- 2 Create I/O tables for the CPU Unit when setting the unit number for the first time or changing settings.

CS-series EtherNet/IP Unit:

CS1W-EIP21

### ● Setting the Front Panel Switches

#### Setting Unit Numbers

Always set the unit numbers so that the unit numbers of other CPU Bus Units mounted to the same CPU Unit are all unique.

Use a small screwdriver to set the rotary switches, being careful not to damage them.

The factory setting is 0.

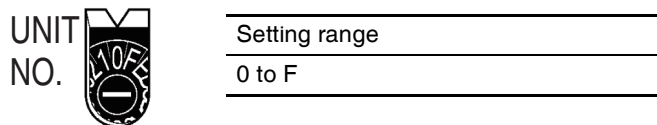

#### Setting Node Numbers

Use the node address switches to set the node address to a unique hexadecimal value. Do not set it to the same value as any other Ethernet/IP Unit or built-in port on the same Ethernet/IP network. As long as it does not duplicate the address of any other Ethernet/IP Unit or built-in port, the node address can be set from 01 to FE hex (1 to 254 decimal).

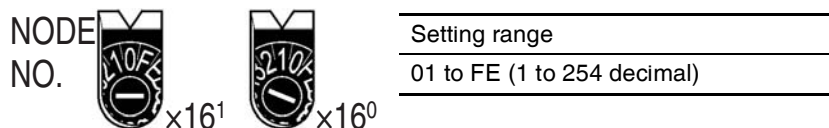

Set the upper digit using the left rotary switch and the lower digit using the right rotary switch.

The factory setting is 01. The Node ID of the rotary switch here must be consistent with that of PLC in the "Communication Setting" dialog box for the actual project created in the NB-Designer.

### ● Setting Local IP Addresses

Set the local IP address with the CX-Programmer or other Support Software.

For the setting procedure, refer to the *SYSMAC CS/CJ-series Ethernet/IP Units Operation Manual* (Cat. No. W465).

### ● Ethernet Connectors

This is the connector used to connect the twisted-pair cable to the Ethernet.

- Electrical Characteristics: Conforms to IEEE802.3 standards.
- Connector Layout: RJ45 8-pin modular connector (conforms to ISO 8877).

## Connecting to a CJ-series Ethernet/IP Unit

**Note 1** Always turn OFF the power to the PLC before setting the rotary switches.

2 Create I/O tables for the CPU Unit when setting the unit number for the first time or changing settings.

CJ-series EtherNet/IP Unit:

CJ1W-EIP21

### ● Setting the Front Panel Switches

#### Setting Unit Numbers

Always set the unit numbers so that the unit numbers of other CPU Bus Units mounted to the same CPU Unit are all unique.

Use a small screwdriver to set the rotary switches, being careful not to damage them.

The factory setting is 0.



UNIT  
No.

Setting range
---------------

0 to F
--------

#### Setting Node Numbers

Use the node address switches to set the node address to a unique hexadecimal value. Do not set it to the same value as any other Ethernet/IP Unit or built-in port on the same Ethernet/IP network. As long as it does not duplicate the address of any other Ethernet/IP Unit or built-in port, the node address can be set from 01 to FE hex (1 to 254 decimal).



x16<sup>1</sup>



NODE  
No.  
x16<sup>0</sup>

Setting range
---------------

01 to FE (1 to 254 decimal)
-----------------------------

Set the upper digit using the left rotary switch and the lower digit using the right rotary switch.

The factory setting is 01. The Node ID of the rotary switch here must be consistent with that of PLC in the “Communication Setting” dialog box for the actual project created in the NB-Designer.

### ● Setting Local IP Addresses

Set the local IP address with the CX-Programmer or other computer support software. Refer to the *Ethernet/IP Unit Operation Manual* (Cat. No. W465) for details on setting methods.

### ● Ethernet Connectors

This is the connector used to connect the twisted-pair cable to the Ethernet.

- Electrical Characteristics: Conforms to IEEE802.3 standards.
- Connector Layout: RJ45 8-pin modular connector (conforms to ISO8877).

## 2-5-5 Parameter Settings at Host Side (CX-Programmer)

Because the port number of NB is dynamic, the user doesn't need to set it during the communications through the UDP protocol. But user needs to set the UDP parameters at the Host side of OMRON PLC in the CX-Programmer referring to the following limitations.

Take the settings of CJ1W-ETN21 as example:

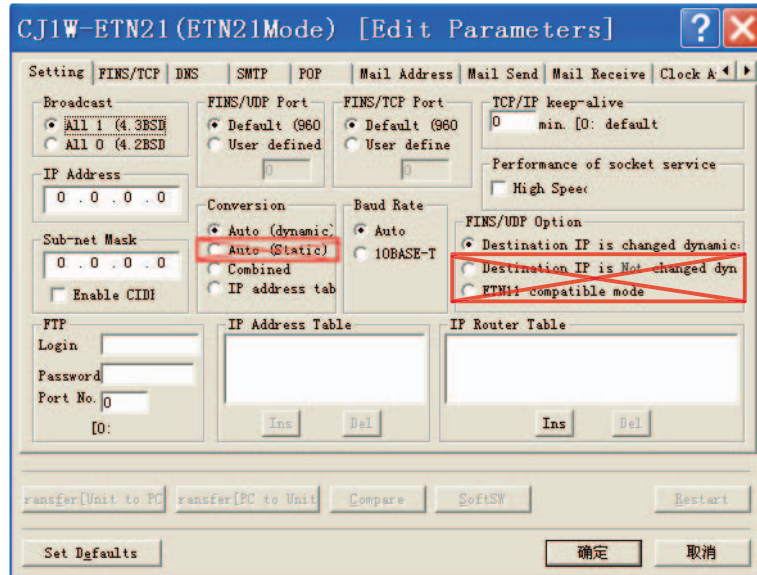

The limitations are as follows:

1. Do not check the "Auto (Static)" option in the [Conversion] check box.
2. Do not check the "Destination IP is Not changed dyn:" in the [FINS/UDP Option] check box.
3. Only the "Destination IP is changed dynamic:" can be checked in the [FINS/UDP Option] check box after either of "Auto (dynamic)", "Combined" and "IP address table" is checked in the [Conversion] check box. When insert the IP address into the [IP Address Table] after the "IP address table" or "Combined" is checked, do not make the Node ID of NB into it. \*1

\*1 If the Node ID of NB is placed into the [IP Address Table], the system will require the NB to use the same port with the PLC, and "PLC response error" information will appear on NB.

The prompts for possible errors occurred to NB when UDP protocol is adopted are described as follows:

"PLC Response Error": Response to the abnormal information caused by the Read/Write command to PLC.

"PLC No Response: xx-xx-x": No response is made by PLC and xx-xx-x represents PT No.-Node ID of PLC-Port Number.

## 2-5-6 Parameter Settings at Host Side (Sysmac Studio)

Because the port number of NB is dynamic, the user doesn't need to set it during the communications through the OMRON CJ/CS/NJ Series or NX1 Series Ethernet UDP driver. But user needs to set the UDP parameters of the NJ-series controller in the Sysmac Studio referring to the following limitations.

Take the settings in the Sysmac Studio as example:

- **[TCP/IP] settings dialog**

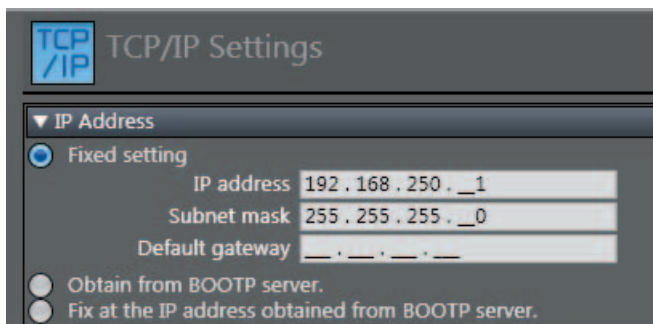

- **[FINS settings] dialog**

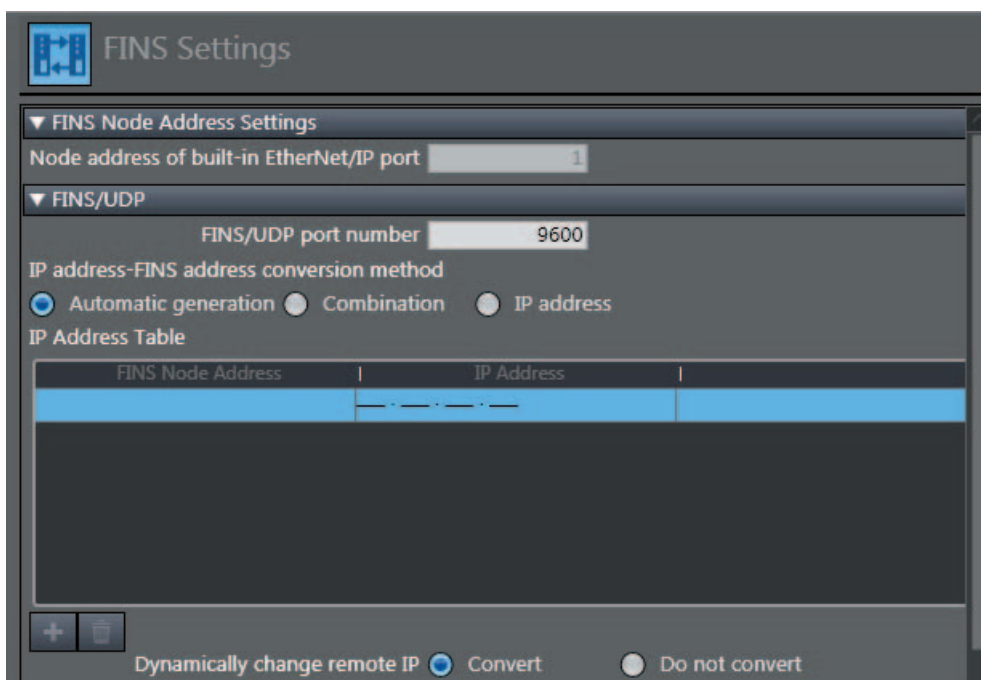

The limitations are as follows:

1. Select the “Convert” in the [Dynamically change remote IP] setting.
2. Set the IP address in the [IP Address Table] when either the “IP address” or “Combination” is selected in the [IP address-FINS address conversion method] setting and do not set the Node ID of NB into it. \*1

\*1 If the Node ID of NB is placed into the [IP address Table], the system will require the NB to use the same port with the PLC, and “PLC response error” information will appear on NB.

The prompts for possible errors occurred to NB when OMRON CJ/CS/NJ Series or NX1 Series Ethernet UDP driver is adopted are described as follows.

“PLC Response Error”: Response to the abnormal information caused by the Read/Write command to PLC.

“PLC No Response: xx-xx-x”: No response is made by PLC and xx-xx-x represents PT No.-Node ID of PLC-Port Number.





# 3

## System Setting Mode

This section describes the System Setting Mode

---

<b>3-1</b>	<b>Display Method of System Setting Mode</b>	<b>3-2</b>
<b>3-2</b>	<b>Functions of System Setting Mode</b>	<b>3-3</b>

## 3-1 Display Method of System Setting Mode

---

Enter the System Setting Mode following the procedures below.

- (1) To start the NB unit and display the Start Menu, turn on the power of the NB unit while pressing the upper left corner of the NB unit's touch panel.

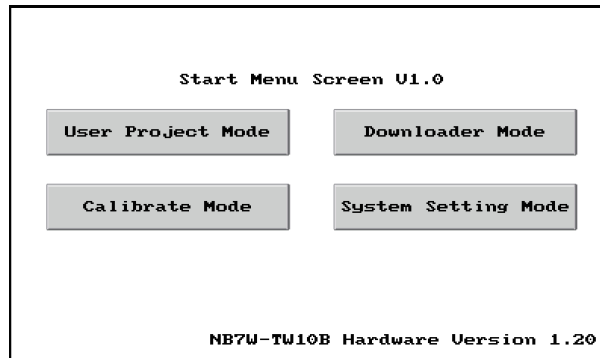

- (2) To enter System Setting Mode, press the [System Setting Mode] button.

## 3-2 Functions of System Setting Mode

The following items can be set in System Setting Mode:

- (1) Time calibration: check whether the year, month, day, hour, minute and second are the current time values, and if not, rectify them manually.
- (2) IP Address (Only supported by NB7W-TW11B): Sets the IP address for PT.  
Port (Only supported by NB7W-TW11B): Sets the port number.  
Subnet Mask (Only supported by NB7W-TW11B): Sets the subnet mask.  
Gateway (Only supported by NB7W-TW11B): Sets the gateway.
- (3) Startup Window No.: the window displayed after launching the NB Unit. The default is window 0.
- (4) Backlight Saver Time: time to activate the screen saver, and the Unit is minute. The default is 10 minutes. The screen saver is not brought into effect when the set value is 0.
- (5) Mute Enabled/Disabled: ON/OFF of the buzzer.
- (6) Brightness Up/Down: with this, brightness of the screen can be adjusted, bringing the screen to its best visual effect.
- (7) Enable Printer Function: refer to *Section 7 Pictbridge Printing in NB-Designer Operation* for details.

The System Setting Mode screen of the NB7W-TW11B is as follows:

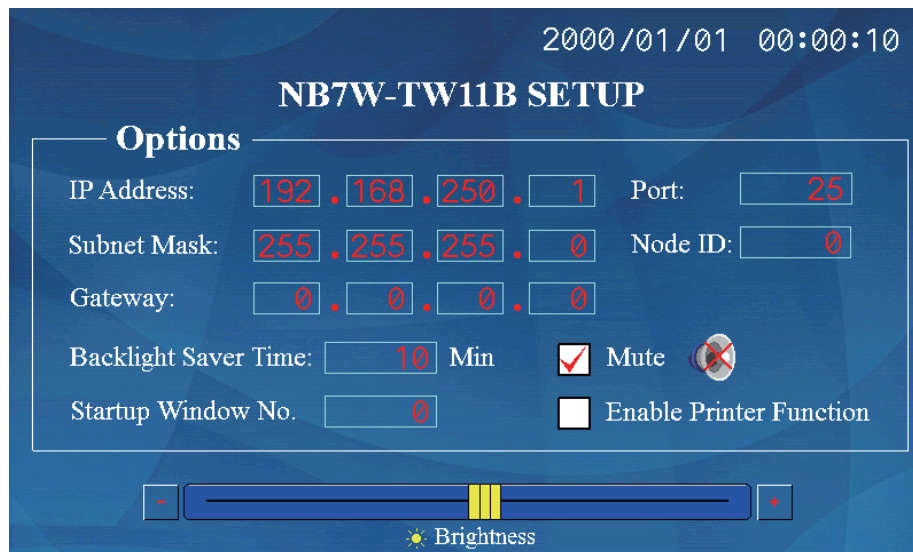

The System Setting Mode screen of the NB7W-TW10B is as follows:

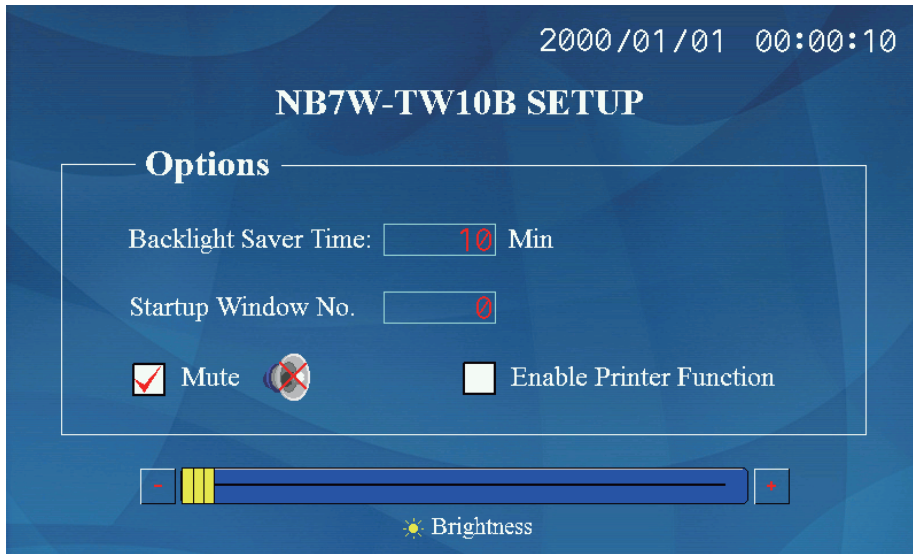

If you want to change the month, touch where the month is (eg. 09), and a digit input keyboard will pop up. Input the month value, and touch the Enter button to confirm the change.

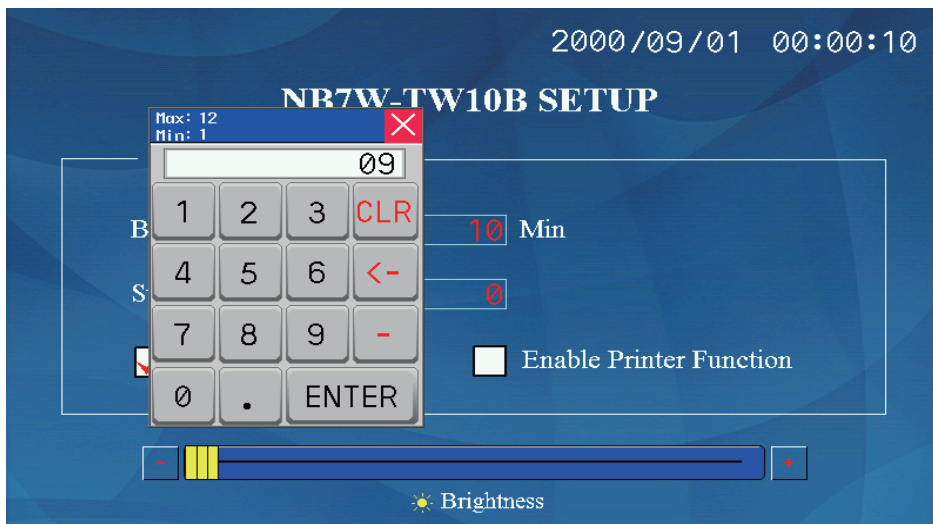

# 4

## Calibrate Mode

---

This section describes the Calibrate Mode.

---

<b>4-1</b>	<b>Display Method of Calibrate Mode</b>	<b>4-2</b>
<b>4-2</b>	<b>Functions of Calibrate Mode</b>	<b>4-2</b>
<b>4-3</b>	<b>On-line Touch-control Calibration Function</b>	<b>4-2</b>

## 4-1 Display Method of Calibrate Mode

---

There are 2 methods for entering into Calibrate Mode.

- (1) To start the NB unit and display the Start Menu, turn on the power of the NB unit while pressing the upper left corner of the NB unit's touch panel.  
To enter Calibrate Mode, press the [Calibrate Mode] button.

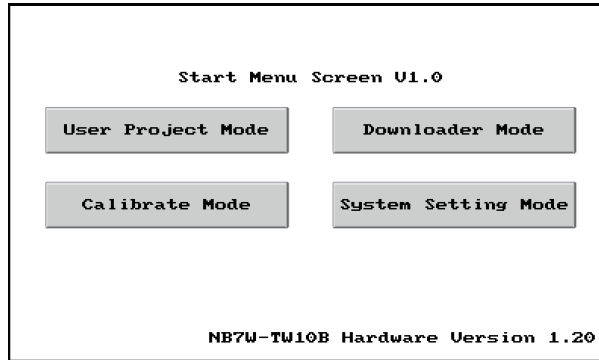

- (2) Place a "Function Key" component in the window, and set its function to "Touch Calibration". Touch the "Function Key" component in the window to start Calibrate Mode.

## 4-2 Functions of Calibrate Mode

---

Procedures to carry out Calibrate Mode:

Track and touch the "+" displayed on the screen and you will hear a "touch". Carry on with this, until the "+" disappear followed by a "TP Adjust Success!" turning up on the screen.

## 4-3 On-line Touch-control Calibration Function

---

Touch-control Calibration can also be achieved with a function key while the software is running, thus sparing the time of equipment adjustment and the trouble of opening the control panel. For details, refer to 3-7-2 *Function Key* in *NB-Designer Operation*.

# App

## Appendices

---

<b>A-1 Specifications</b> .....	<b>A-2</b>
A-1-1 General Specifications .....	A-2
A-1-2 Performance Specifications .....	A-2
A-1-3 Communication Specifications .....	A-4
<b>A-2 External Dimensions</b> .....	<b>A-5</b>
<b>A-3 Fabrication of the Connection Cable</b> .....	<b>A-6</b>
A-3-1 Cable Processing .....	A-6
A-3-2 Soldering .....	A-7
A-3-3 Shield Assembly .....	A-7
A-3-4 Method for Fabricating the Cable for Connection to OMRON PLC .....	A-8
A-3-5 Method for fabricating the cable for connection to PC .....	A-9
<b>A-4 List of Models</b> .....	<b>A-10</b>
<b>A-5 List of Options</b> .....	<b>A-13</b>
<b>A-6 Differences of the hardware between NB and NB-S</b> .....	<b>A-14</b>

# A-1 Specifications

## A-1-1 General Specifications

Items	Specifications	
	NB7W	
	TW10B	TW11B
Rated power supply voltage	DC24V±15%(DC20.4~27.6V)	
Power consumption	7W	6W
Ambient operating temperature	0°C~50°C	
Ambient storage temperature	-20°C~60°C	
Ambient operating humidity	10%~90% RH (without condensation)	
Ambient storage humidity	10%~90% RH (without condensation)	
Operating environment	No corrosive gases	
Noise Immunity	Compliant with IEC61000-4-4, 2KV (Power cable)	
Vibration resistance (During operation)	10 to 57Hz with a 0.075mm amplitude, 57 to 150Hz 9.8m/s <sup>2</sup> for 30 min each in X, Y and Z directions	
Shock resistance (During operation)	147m/s <sup>2</sup> for 3 times each in X, Y and Z directions, with each time lasting for 11 ms	
Dimensions W×H×D(mm)	202.0×148.0×46.0	
Panel opening dimension W×H(mm)	191.0×137.0	
Panel thickness range	1.6~4.8 mm	
Weight	603g	607g
Degree of protection	Front operation part: IP65 (Dust proof and drip proof only from the front of the panel)	
Applicable standards	EU Directives, UL61010-2-201	

**Note 1** OMRON accepts repair and analysis of the NB Units including the display device for five years of the manufacture date.

**2** The flash memory can be rewritten approximately 100,000 times at maximum.

## A-1-2 Performance Specifications

### ● Display specifications

Items	Specifications	
	NB7W	
	TW10B	TW11B
Display panel	Display device	7" TFT LCD
	Number of dots	800×480
	Display color	65536 colors
	Valid display area W×H(mm)	154×85
Backlight	Life	50,000 hours (Typ) of operating time at the normal temperature (25 °C) with 40% brightness



● Operation part specifications

Items	Specifications	
	NB7W	
	TW10B	TW11B
Touch panel	Type: resistive type	
	Operation force: 0.5~0.8 N	
	Press endurance: min. 1,000,000 times (at 25 °C)	

● External I/F specifications

Items	Specifications	
	NB7W	
	TW10B	TW11B
USB Slave	1 port (for screen data transmission with a PC and Pictbridge printing) Equivalent of USB 2.0 Full speed	

● Programmer (a software for making screen data, and "✓" mark means support.)

Items	Specifications	
	NB7W	
	TW10B	TW11B
Name/Version		
NB-Designer version 1.4X or later	✓	✓

### A-1-3 Communication Specifications

● **Host Link communication specifications**

Items	Specifications
	NB7W
	TW10B
COM1	Compliant with EIA RS-232C D-sub, 9-pin connector socket Pin 6 DC +5V output (Max. current: 250mA) Communication cable length: Max.15m

● **Ethernet communication specifications**

**Note** The PT of the NB7W-TW11B has the Ethernet connection function.

Items	Specifications
Conformance standards	Conforms to IEEE 802.3 / Ethernet (10/100Base-T)
Transmission medium	2 pair Cat 3 UTP 22 to 26AWG, Cat 5, Cat 5e, Cat 6
Transmission distance	100 m (node-to-hub and hub-to-hub)
Connector	8-pin modular connector

# A-2 External Dimensions

- NB7W-TW10B/NB7W-TW11B model

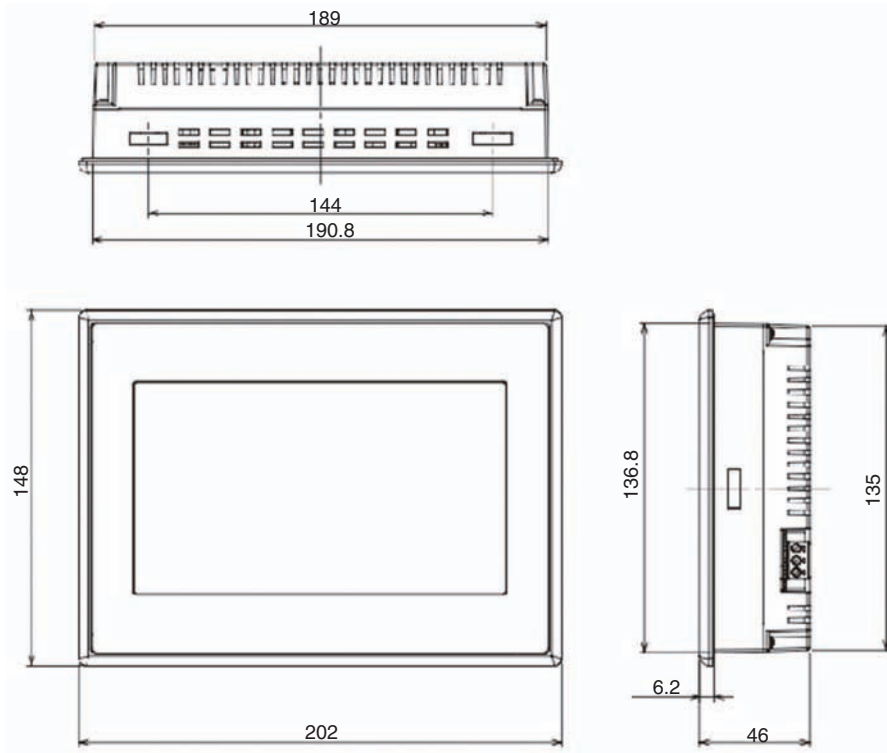

# A-3 Fabrication of the Connection Cable

Fabricate the connection cable following the procedures below.

## A-3-1 Cable Processing

- 1** Cut the cable to the required length.
- 2** Use a tool like a razor, etc. to cut off the ethylene peel of the cable. Be care not to damage the shielding layer (for grouping purpose)
- 3** Use a pair of scissors to snip off the shielding layer.
- 4** Bring out the core of each wire using a wire stripper.
- 5** Fold back the shielding layer.
- 6** Wrap the folded part of the shielding layer with aluminum foil tape.

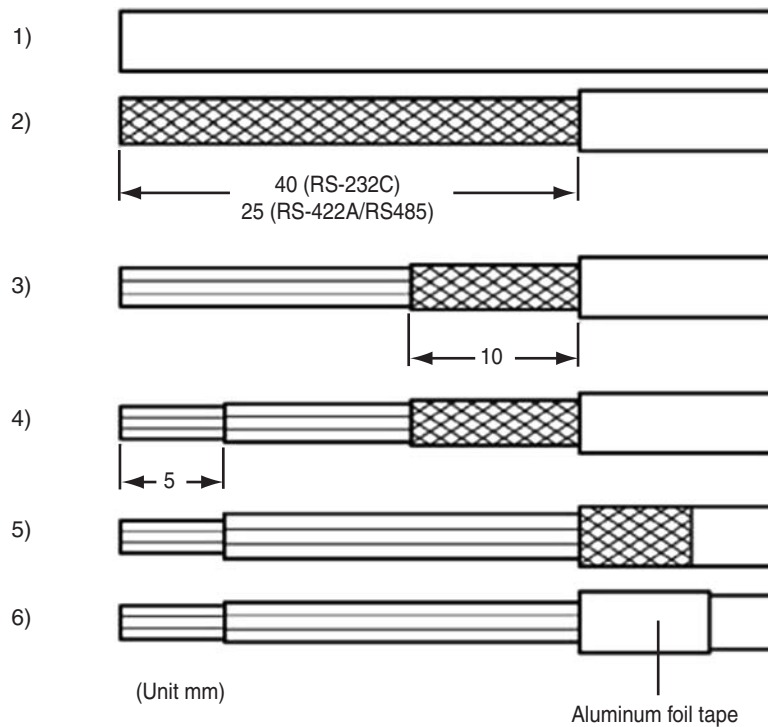

### A-3-2 Soldering

- 1** Sheathe each wire with a heat shrinkable tube.
- 2** Place some standby soldering tin on each wire and each pin of the connector.
- 3** Solder each wire and each pin of the connector.

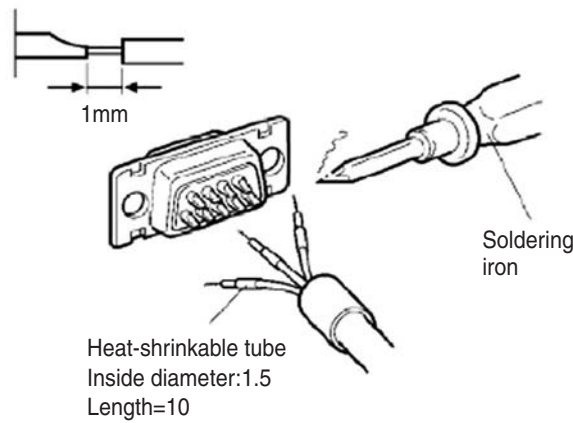

- 4** Pull the heat shrinkable tubes back to the soldering parts, heat them with a heat shrinking gun to make them shrink.

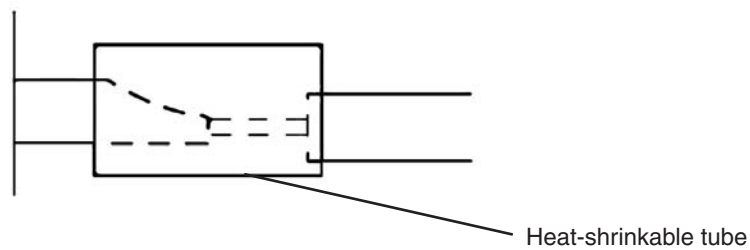

### A-3-3 Shield Assembly

Assemble the connector shield as shown below.

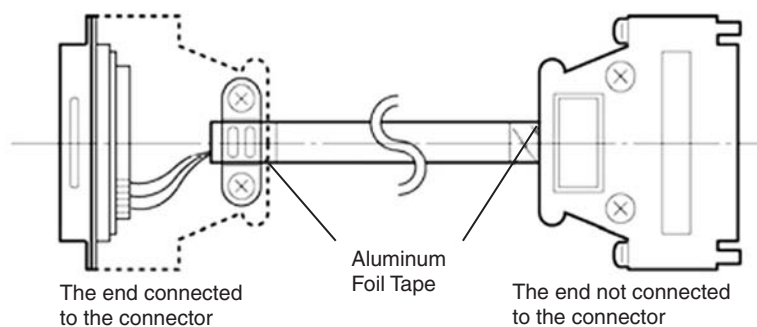

## A-3-4 Method for Fabricating the Cable for Connection to OMRON PLC

When fabricating the cable for connecting the NB Unit and OMRON PLC, refer to the following methods:

These examples assume the CJ1W-SCU□□ OMRON PLC. For the pin numbers, check the specification of the actual target device before connection.

### COM1

#### ● The cable for connecting the NB7W Unit serial port COM1 to OMRON PLC (RS-232C)

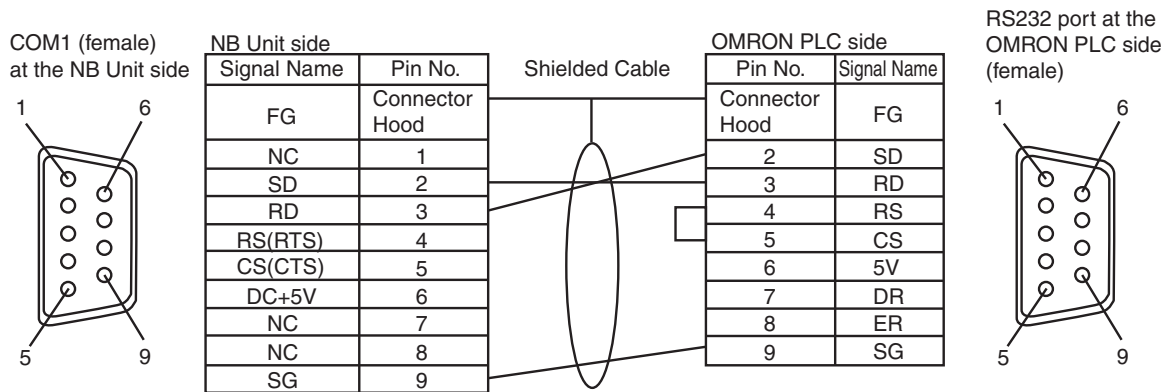

#### ● The cable for connecting the NB7W Unit serial port COM1 to OMRON NX1W-CIF01 (RS-232C)

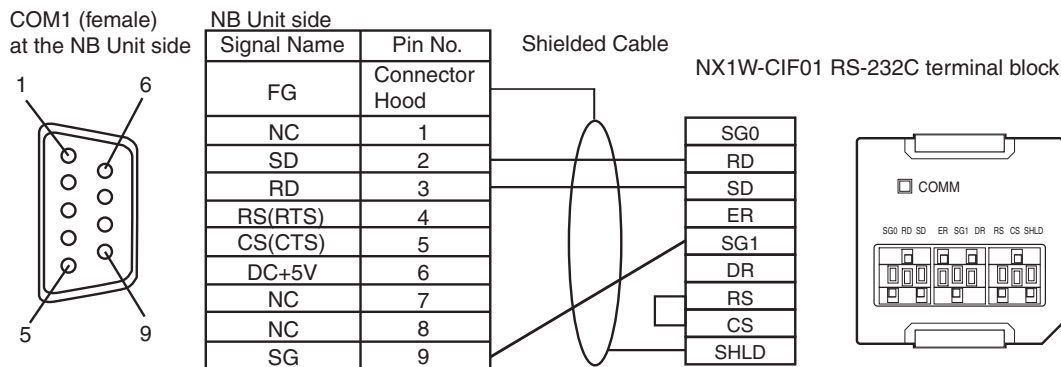

## A-3-5 Method for fabricating the cable for connection to PC

When fabricating the cable for connecting with NB-Designer, refer to the following methods:

Depending on the type of the RS-232C connector compatible with PCs according to DOS/V, deploy the wiring as shown below:

### 25-pin Connector

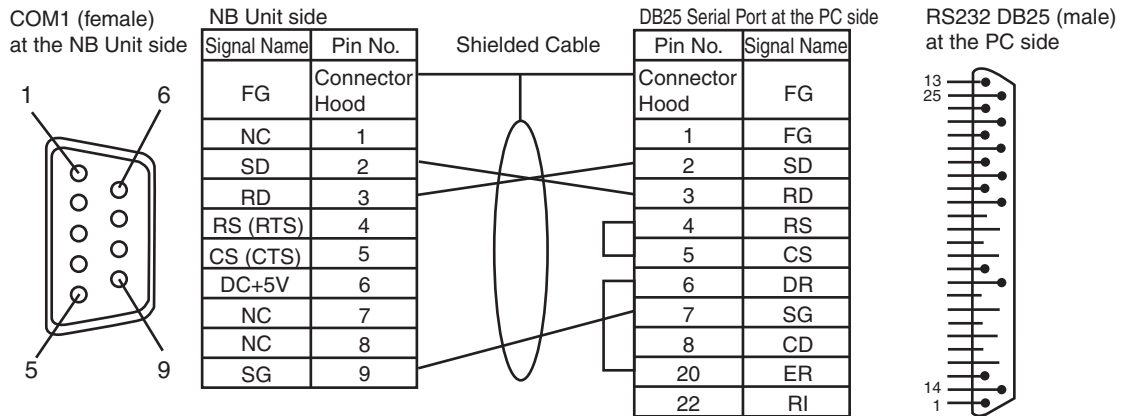

### 9-pin Connector

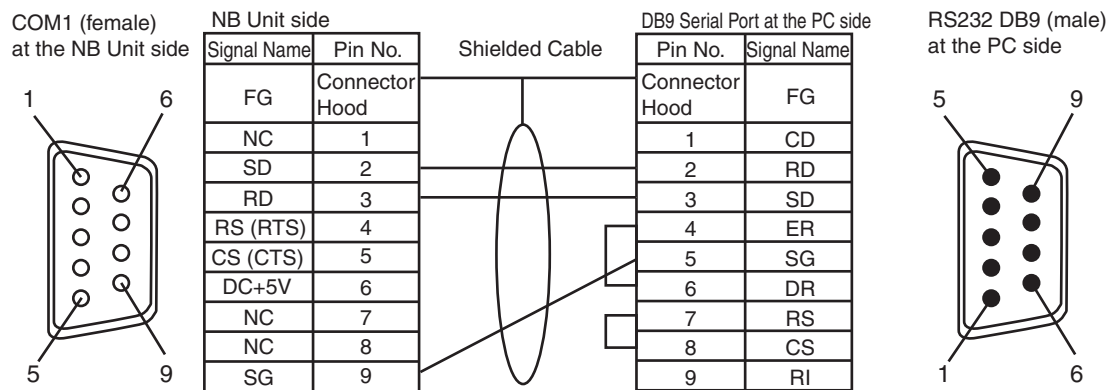

## A-4 List of Models

### ● NB Unit

Models	Resolution	Size	Communication	USB (Equivalent of USB 2.0 Full Speed)
NB7W-TW10B	WVGA 800×480	7 inches	COM1	Slave
NB7W-TW11B	WVGA 800×480	7 inches	Ethernet	Slave

### ● Serial Communication Unit

Models	Specifications	Applicable PLC Series
CS1W-SCB21	• RS-232C (2 ports)	CS series
CS1W-SCB41	• RS-232C (1 port) • RS-422A/485 (1 port)	CS series
CS1W-SCU21	• RS-232C (2 ports)	CS series
CJ1W-SCU21/22	• RS-232C (2 ports)	CJ/NJ series
CJ1W-SCU41/42	• RS-232C (1 port) • RS-422A/485 (1 port)	CJ/NJ series
CP1W-CIF01	• RS-232C (1 port)	CP series
CP2W-CIFD1	• RS-232C (2 ports)	CP series
CP2W-CIFD2	• RS-232C (1 port) • RS-485 (1 port)	CP series

### ● Ethernet Communication Unit

Models	Specifications	Applicable PLC Series
CS1W-ETN21	• 100Base-TX, 10Base-T	CS series
CS1W-EIP21	• 100Base-TX, 10Base-T	CS series
CJ1W-ETN21	• 100Base-TX, 10Base-T	CJ series
CJ1W-EIP21	• 100Base-TX, 10Base-T	CJ series
CP1W-CIF41	• 100Base-TX, 10Base-T	CP series



● Units at the host side which can be connected using the serial port of the NB Unit in the RS-232C mode through Host Link

PLC Series	CPU Unit with built-in Host Link function	CPU Unit that can be connected using Serial Communication Units/Boards	Options required for connection
CP Series		CP1L-L14/L20/M30/M40/M60	CP1W-CIF01
		CP1H-X40/XA40/Y20	CP1W-CIF01
	CP1E-N14/N20		
	CP1E-N30/N40/N60/NA20	CP1E-N30/N40/N60/NA20	CP1W-CIF01
		CP1L-EL20/EM30/EM40	CP1W-CIF01
	CP2E-E14/E20/E30/E40/E60 CP2E-S30/S40/S60	CP2E-N14/N20/N30/N40/N60	CP1W-CIF01 CP2W-CIFD1/CIFD2 (*2)
C Series	C200HE-CPU42 C200HE-CPU42-Z	C200HE-CPU32/42 C200HE-CPU32/42-Z	C200HW-COM02/04/05/06-V1
	C200HG-CPU43/63 C200HG-CPU43/63-Z	C200HG-CPU33/43/53/63 C200HG-CPU33/43/53/63-Z	C200HW-COM02/04/05/06-V1
	C200HX-CPU44/64 C200HX-CPU44/64/65/85-Z	C200HX-CPU34/44/54/64 C200HX-CPU34/44/54/64/65/85-Z	C200HW-COM02/04/05/06-V1
	CPM2C-10/20□□□□□□□□ (*1)		
CS Series	CS1G-CPU42/43/44/45(-V1) CS1H-CPU63/64/65/66/67(-V1)	CS1G-CPU42/43/44/45(-V1) CS1H-CPU63/64/65/66/67(-V1)	CS1W-SCU21(-V1) CS1W-SCB21/41(-V1)
	CS1G-CPU42H/43H/44H/45H CS1H-CPU63H/64H/65H/66H/67H	CS1G-CPU42H/43H/44H/45H CS1H-CPU63H/64H/65H/66H/67H	CS1W-SCU21(-V1) CS1W-SCB21/41(-V1)
CJ Series	CJ1G-CPU44/CPU45	CJ1G-CPU44/CPU45	CJ1W-SCU21/41/-V1
	CJ1G-CPU42H/43H/44H/45H CJ1H-CPU65H/66H/67H	CJ1G-CPU42H/43H/44H/45H CJ1H-CPU65H/66H/67H	CJ1W-SCU21/41/-V1
	CJ1M-CPU11/12/13/21/22/23	CJ1M-CPU11/12/13/21/22/23	CJ1W-SCU21/41/-V1
	CJ2M-CPU31/32/33/34/35		CP1W-CIF01
	CJ2M-CPU11/12/13/14/15		
	CJ2H-CPU64/65/66/67/68(-EIP)		
NJ Series		NJ501/301/101	CJ1W-SCU22/42
NX Series		NX1P2	NX1W-CIF01

\*1: Connect using conversion cables (CPM2C-CN111 type or CS1W-CN114/118 type), the RS-232C adaptor (CPM1-CIF01 type).

\*2: CP2W-CIFD1 option board has 2 RS-232C serial ports with different protocols. Connection with NB HMI is available only through Port 1.

● **Units at the host side which can be connected using the Ethernet port of the NB Unit**

PLC Series	CPU Unit with built-in Ethernet communication function	CPU Unit that can be connected through adding Ethernet Communication Unit/optional communication board	Options required for connection
CP Series		CP1L-L14/L20/M30/M40/M60	CP1W-CIF41
		CP1H-X40/XA40/Y20	CP1W-CIF41
		CP1E-N30/N40/N60/NA20	CP1W-CIF41
	CP1L-EL20/EM30/EM40		
	CP2E-N14/N20/N30/N40/N60		
CS Series		CS1G-CPU42/43/44/45(-V1) CS1H-CPU63/64/65/66/67(-V1)	CS1W-ETN21 CS1W-EIP21
		CS1G-CPU42H/43H/44H/45H CS1H-CPU63H/64H/65H/66H/67H	CS1W-ETN21 CS1W-EIP21
		CS1H-CPU63/64/65/66/67(-V1)	CS1W-ETN21 CS1W-EIP21
		CS1H-CPU63H/64H/65H/66H/67H	CS1W-ETN21 CS1W-EIP21
CJ Series		CJ1G-CPU42H/43H/44H/45H CJ1H-CPU65H/CPU66H	CJ1W-ETN21 CJ1W-EIP21
		CJ1M-CPU11/12/13/21/22/23	CJ1W-ETN21 CJ1W-EIP21
		CJ1H-CPU65H-R/66H-R/67H-R CJ1H-CPU65H/CPU66H	CJ1W-ETN21 CJ1W-EIP21
	CJ2M-CPU31/32/33/34/35		
		CJ2M-CPU11/12/13/14/15	CJ1W-ETN21 CJ1W-EIP21
	CJ2H-CPU64/65/66/67/68(-EIP)		
NJ Series	NJ501/301/101		
NX Series	NX102		
	NX1P2		

● **NB-Designer information**

Descriptions	Remarks
The software that creates screen data for NB/NB-S series PT.	OS: Windows XP (SP3 or higher) Windows Vista/Windows 7 / 8 / 8.1 / 10 (32/64-bit) The NB-Designer incorporates a transmission program and a standard system program specified for the NB-Series Units. For download the application programs, please access your local Omron website, If local site cannot be found, please access Omron IA global site "http://www.ia.omron.com/" at first and select the area where you are.

● **Related connecting objects**

Cable with connectors (NB Unit ↔ PLC)

Models	Cable Length	Object Unit	Communications methods	Specifications
XW2Z-200T	2m	Units with 9-pin connectors by OMRON	Host Link (RS-232C)	9-pin ↔9-pin
XW2Z-500T	5m			

## A-5 List of Options

---

- **Protective Sheet**

It adheres to the display preventing reflection and also dirt from sticking to the display. The sheet is colorless and transparent, with 1 set containing 5 pieces.

NB Unit Models	Models	Specifications
NB7W-TW1□B	NB7W-KBA04	5 pieces

## A-6 Differences of the hardware between NB and NB-S

Differences between the hardware of the NB series and the NB-S series are described below.

Model	NB series		NB-S series	
	NB7W-TW00B	NB7W-TW01B	NB7W-TW10B	NB7W-TW11B
Front-side LED	ON: power connected OFF: power disconnected		No	
USB Host	No	1 port Equivalent of USB2.0 Full speed	No (*1)	
COM1	Compliant with EIA RS-232C D-sub, 9-pin connector socket Pin 6 DC +5V output (Max. current: 250mA) Communication cable length: Max.15m			No
COM2	Compliant with EIA RS-232C/422A/485 D-sub, 9-pin connector socket At one point, only one from RS-232C, RS-422A and RS-485 can be designated to perform communications Communication cable length: Max.15m (RS-232C) Max. 500m (RS-422A/485)		No	
Battery	Yes		No	
RTC	Yes		No (*2)	
DIP switches	Yes		No (*3)	
Reset switch	Yes		No	

\*1: Functions that use a USB memory device cannot be used.

\*2: There are limitations on the functions related to clock data.

\*3: The operation mode is changed using the touch panel. Refer to *2-2 Start of NB-S series in PT Setup*.

# 1

## Introduction

This section provides an outline of the NB-S series PTs, including their functions, features, connection types and communication methods.

---

<b>1-1</b>	<b>Functions and Structure of NB-S series PTs</b>	<b>1-2</b>
1-1-1	How NB-S series PTs Work at FA Production Sites	1-2
1-1-2	Operations of NB-S series PTs	1-2
<b>1-2</b>	<b>Communicating with the Host</b>	<b>1-4</b>
1-2-1	What's the Host Link?	1-4
1-2-2	Connecting Methods	1-5
1-2-3	Communicating with the PLC Manufactured by Other Companies	1-5
<b>1-3</b>	<b>System Configuration</b>	<b>1-6</b>
1-3-1	Connectable Peripheral Devices	1-6
<b>1-4</b>	<b>Procedures for NB-S series PTs' Operation</b>	<b>1-7</b>

# 1-1 Functions and Structure of NB-S series PTs

The NB-S series Programmable Terminals (PTs) are sophisticated operator interfaces that can indicate information and perform operations as required at FA production sites. This section provides a brief of the roles and performances of the NB-S series PTs for beginning users.

## 1-1-1 How NB-S series PTs Work at FA Production Sites

- **Monitoring Line Operating Status**  
The device and operation status of the system can be displayed in real time. Using graphic charts or other allows display data in easy-to-understand format.
- **Instructing FA Staff**  
PTs can be used to notify system operators if there is a system or device error and to indicate countermeasures and necessary information.
- **Controlling Panel Switches**  
NB-S series PTs allow the users to create various kinds of switches on the displayed screen. The values allocated to the switches can be sent to the host by clicking the switches.

## 1-1-2 Operations of NB-S series PTs

### ● Transferring Screen Data

The screen data displayed on NB-S series PTs is created by using NB-Designer in the PC. The screen data is transferred to the NB units through the USB, Ethernet, and the RS-232C.

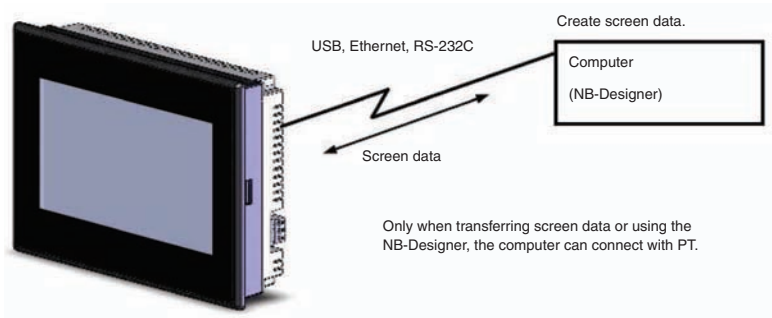

### ● Displaying Screens

The data to be displayed on the screens is created by using NB-Designer in PC and the data is transferred to the PT. The required screen can be displayed by a command from the host or by operating the touch switches.

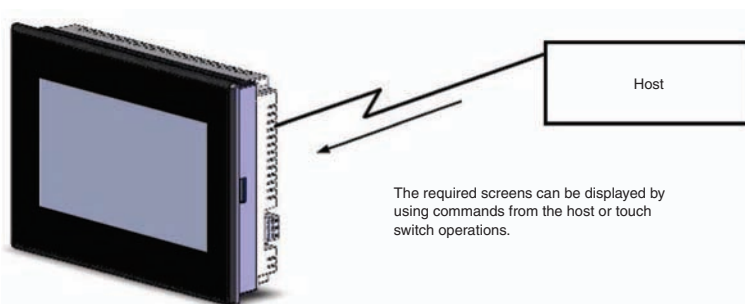

### ● Reading Data from the Host

NB-S series PTs can be connected to the host by using communication methods such as RS-232C or Ethernet to automatically read the required data from the host.

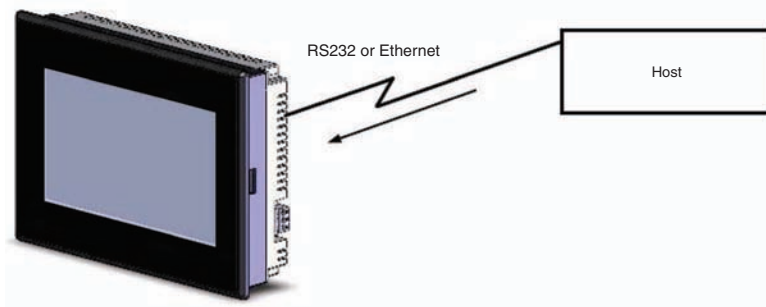

### ● Sending Data to the Host

The data entered from the touch panel (ON/OFF button status, numeric data and character strings) can be sent to the host.

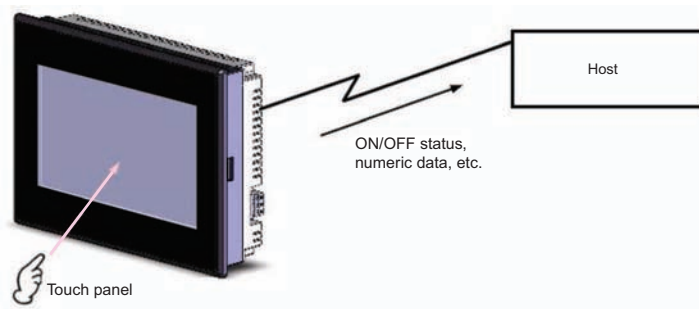

## 1-2 Communicating with the Host

With NB-S series PTs, data required for display can be accessed and the words and bits where the entered data will be stored can be allocated to any area in the PLC. The operations include the direct reading and writing of the allocated words and bits, the modification of the display status for the functional objects on the PT screen, and the control and report of the PT status.

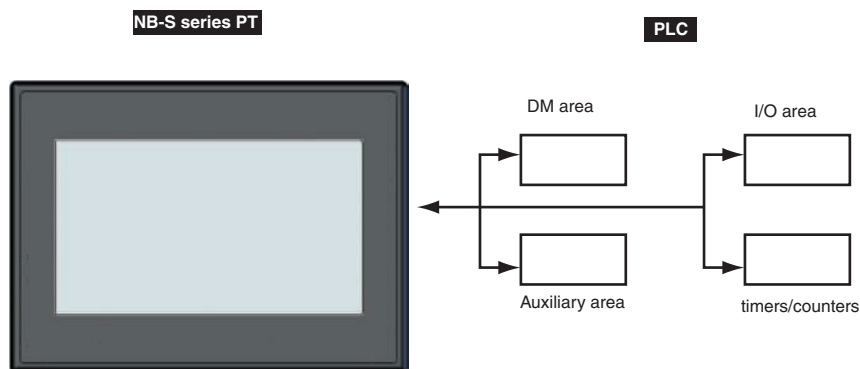

NB-S series PTs can be connected to the PLC manufactured by OMRON using the Host Link method.

### 1-2-1 What's the Host Link?

The Host Link is a kind of optimized and economical communication method for FA system, which is applicable to link one PT with one PLC or more. The PC can be used to transfer programs to the PLC, monitor the data area of PLC and control the operation of PLC. The NB-S series PTs, however, only support 1:1 communication. Do not connect multiple PLCs with an NB Unit.

In the system using Host Link system, one PT sends Host Link commands to the PLC and the commands' processing is completed followed by returning the results of the processing by the PLC (the host).

System Features:

Connection method: RS-232C

Transmission rate (baud rate): 4800, 9600, 14400, 19200, 38400, 56000, 57600, 115200 and 187500 bps.

The transmission rates of 14400, 56000 and 187500 bps are not supported by the PLC manufactured by OMRON.

Host monitoring: The PC can be used to transfer or read the PLC programs, and perform reading and writing of the data area of PLC.

Error check system: Both parity and frame check are performed to estimate the errors occurring during all the communications.



## 1-2-2 Connecting Methods

### RS-232C

RS-232C is a kind of serial physical interface standard formulated by Electric Industry Association (EIA).

RS-232C method is based on 1:1 communication, which is applied to the point-to-point communication within 15-meter distance due to the existence of common-ground noise and the unavoidable common-mode interference etc.

### Ethernet

Ethernet is a kind of baseband LAN specification, established by Xerox company and jointly developed by Xerox, Intel and DEC companies, which is the most common communication protocol standard adopted by the existing LANs. PT uses the standard UTP as the transmission media for the Ethernet. The NB-S series use UTP cables.

The network communications between PT and PLC can be realized through the Ethernet connection. Connecting the PT and the PLC manufactured by OMRON through the Ethernet allows the data read and written. What's more, connecting the PT with PC via the Ethernet can also perform the project upload/download and the system processing.

## 1-2-3 Communicating with the PLC Manufactured by Other Companies

Besides the connection with the PLC manufactured by OMRON, NB-S series PTs can also communicate with the devices manufactured by SIEMENS, Mitsubishi Electric Corporation, Schneider Electric, Ltd., Delta, Panasonic, Allen-Bradley, GE Fanuc Automation Inc., LG and the PLCs supporting Modbus protocol. For the manufacturers and the models of the PLCs that can be communicated with, refer to [NB Series Host Connection Manual].

# 1-3 System Configuration

## 1-3-1 Connectable Peripheral Devices

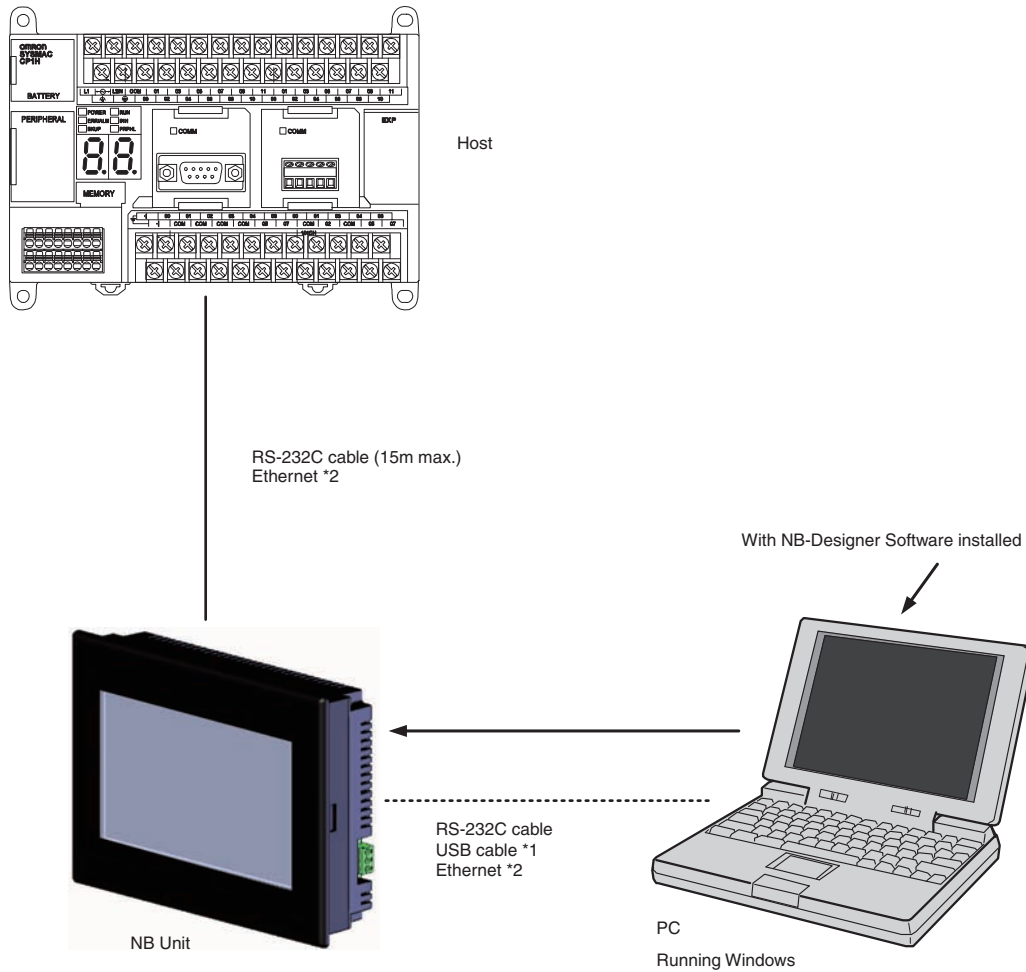

- \*1 When using USB to connect NB Unit with the computer, please refer to 2-3-2 *Connecting by USB* in *PT Setup*.
- \*2 When connecting NB□□-TW11B and the Host through the Ethernet, the Host should support the Ethernet communications.

# 1-4 Procedures for NB-S series PTs' Operation

Perform the following procedures to operate the NB-S series PTs.

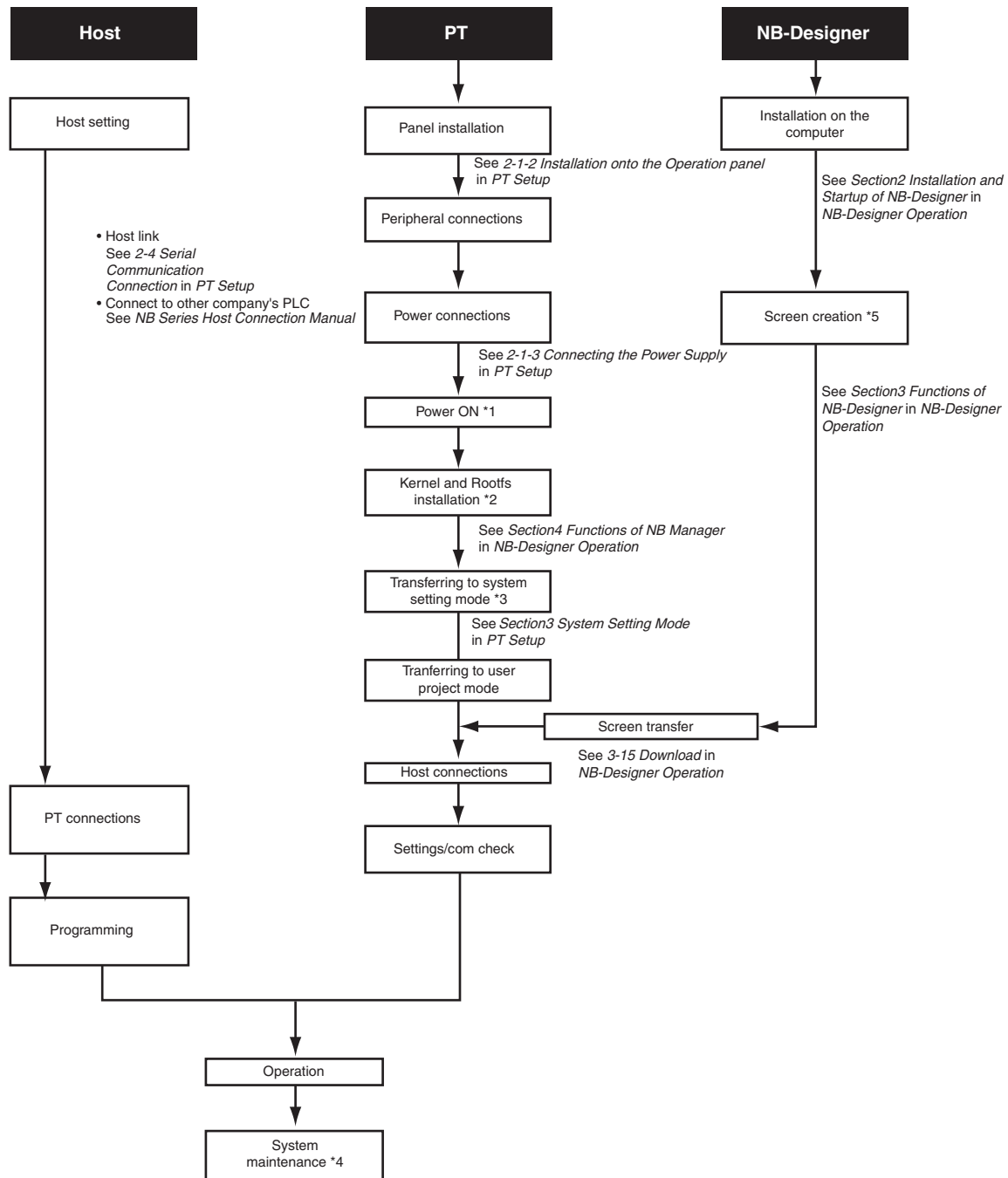

\*1 The system will enter RUN mode after the screen data is input.

\*2 System program is installed only under special circumstances, such as when the system program is transformed or repaired.

\*3 The system setting mode can be entered by long-pressing the upper left corner of the screen for at least 3 seconds when turning the power ON.

\*4 When the abnormalities occur during the operation, the operations such as checking input/output and confirming the setting state etc can be performed as required.

\*5 Use only alphanumeric in a file name of a project file or graphic library and folder where those files are stored. It may cause a compile error when edited in countries except the file's origin country.



# 2

## Installation and Startup of NB-Designer

The NB-Designer software needs to be installed on your computer when you use it for the first time.  
NB-Designer is a kind of application software running in Windows developed by Microsoft Corporation.

---

<b>2-1</b>	<b>Before Installation</b>	<b>2-2</b>
<b>2-2</b>	<b>Installation/Uninstallation</b>	<b>2-3</b>
2-2-1	Installation Procedure	2-3
2-2-2	Uninstallation Procedure	2-3
<b>2-3</b>	<b>Startup &amp; Quit</b>	<b>2-4</b>
2-3-1	Starting Method	2-4
2-3-2	Quitting Method	2-4
<b>2-4</b>	<b>Installation of USB Driver for NB</b>	<b>2-5</b>

## 2-1 Before Installation

The system environment to run the NB-Designer is as follows.

### System Configuration

Items	Minimum Configurations
Operating System (OS)	Microsoft Windows XP (SP3 or higher) Microsoft Windows Vista (32-bit or 64-bit edition) Microsoft Windows 7 (32-bit or 64-bit edition) Microsoft Windows 8 (32-bit or 64-bit edition) Microsoft Windows 8.1 (32-bit or 64-bit edition) Microsoft Windows 10 (32-bit or 64-bit edition)
CPU	Intel Pentium II or higher
Memory	512 MB or more
Hard Disk	2.5 GB or more, with the disk space more than 800 MB at least
Display	Supports the display with resolution of 800×600 and 16-bit high color (1024×768 and 32-bit true color are recommended.) 100% (96DPI) is recommended for Windows Text size (DPI) settings.
RS-232C COM Port	One port or more is kept for the serial communication used by the touch panel.
USB Port	USB 1.1 or higher
CD-ROM Drive	4x or higher

## 2-2 Installation/Uninstallation

### 2-2-1 Installation Procedure

- 1** Start Windows.
- 2** Double click [Setup\_NBD\_V□□□] to perform the installation.  
**Note** For download the application programs, please access your local OMRON website. If local site cannot be found, please access OMRON IA global site "http://www.ia.omron.com/" at first and select the area where you are.
- 3** Select your language to use the program in the [Choose Installation Language] window, and click NEXT.
- 4** Click the [Next] again to display the [Select the Destination Location] dialog box.
- 5** After selecting default of the installing location, click the [Next].
- 6** To select another available location to install, click [Browse]. After a folder list appears, select an available folder to install NB-Designer. Then click the [OK] and followed by [Next].
- 7** When [Ready to install the program] dialog box appears, click [Install] to start installation.
- 8** When [InstallShield Wizard is completed] dialog box appears, click [Finish] to complete the installation.
- 9** Start NB-Designer on Windows other than Windows XP.  
If you use NB-Designer on Windows other than Windows XP, NB-Designer is executed with administrator authority.

### 2-2-2 Uninstallation Procedure

Perform [Uninstall or change a program] in Windows.

**Note** When using new-version software to update a project created with software of an old version, backup necessarily the project before update.



#### **Precautions for Correct Use**

In order to use the product correctly, when running the software, do not perform definitely update, restoration, uninstallation, and reinstallation.

## 2-3 Startup & Quit

This section provides a brief for startup and quit of NB-Designer.

### 2-3-1 Starting Method

Select [Start]-[All Programs]-[OMRON]-[NB-Designer]-[NB-Designer]. The startup can also be realized by double clicking the shortcut icon  on the desktop.

- The user should run this program as an administrator in operation system of Windows other than Windows XP.
- When the NB-Designer is started for the second time, the project operated last time will be opened automatically.
- During the first launch of NB-Designer, the following screen will be displayed.

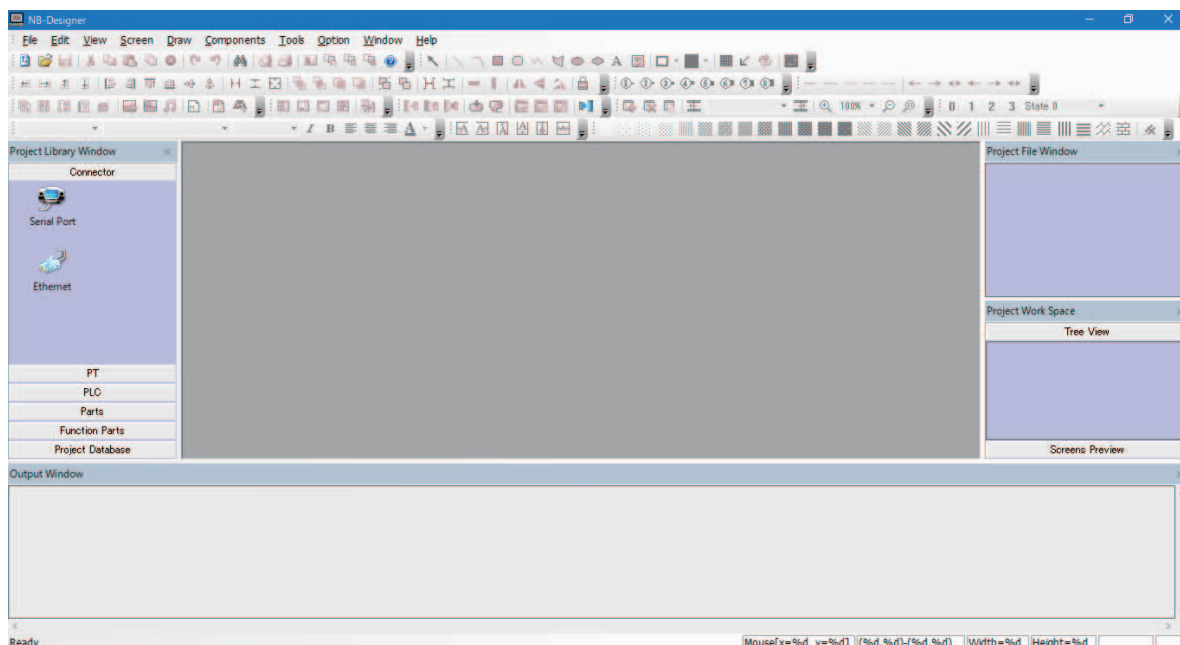

### 2-3-2 Quitting Method

To quit the NB-Designer can be realized by using any one of the following methods.

- Select [Exit] in the [File] menu.
- Click the button in the upper right corner of the main window.
- Double click the NB-Designer icon in the upper left corner of the main window.
- Click the NB-Designer icon in the upper left corner of the main window, and select [Close] from the displayed control menu bar.
- Press the [Alt] key and [F4] key simultaneously.

**Note** When the edited data in the file is not saved, "Save the Current Project?" dialog box will pop up.



## 2-4 Installation of USB Driver for NB

Install the USB driver for NB on PC.

After the installation, the data transmission between the PC and the NB Unit is available via USB.

Because the USB driver included in the NB-Designer is certified by Microsoft, it will be installed automatically accompanying with the software installation, so there is no need to install the USB driver by manual again.

### ● Operating procedure

- 1 After the USB slave for the NB Unit and the computer are connected by the USB cable, “Found New Hardware Wizard” will be displayed on PC. After selecting [Install the software automatically (Recommended)], click the [Next] button.

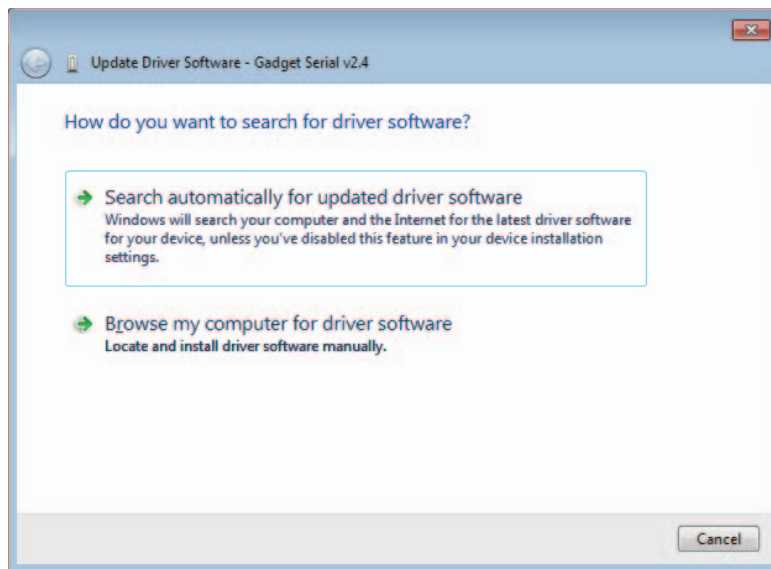

- 2 USB driver is being installed.

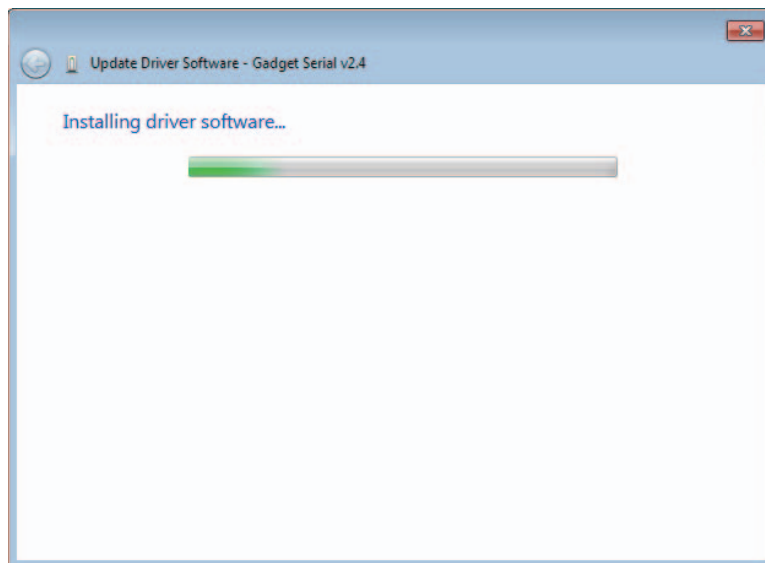

- 3** After the completion of installation, the following dialog box will be displayed. Click the [Close] button.

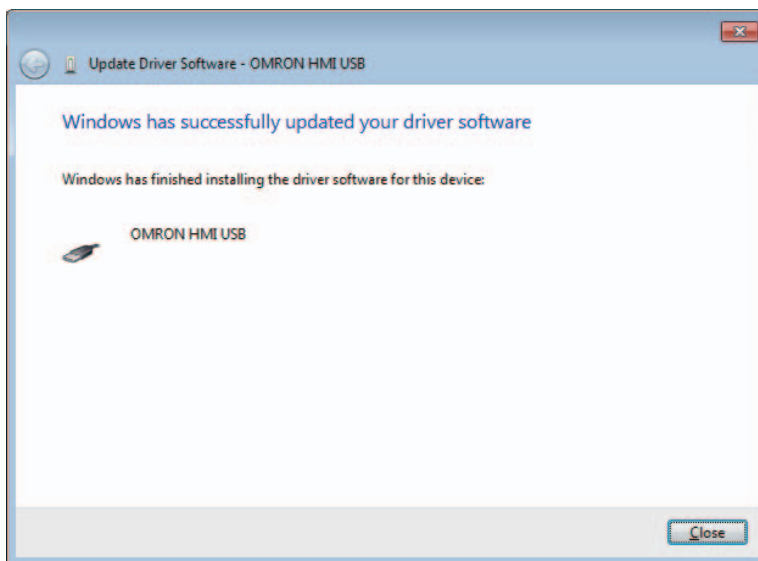

● **When the above-mentioned installation methods don't work.**

- 1** After the USB slave for the NB Unit and the computer are connected by the USB cable, "Update Driver Software" will be displayed on PC. After selecting [Browse my computer for driver software].

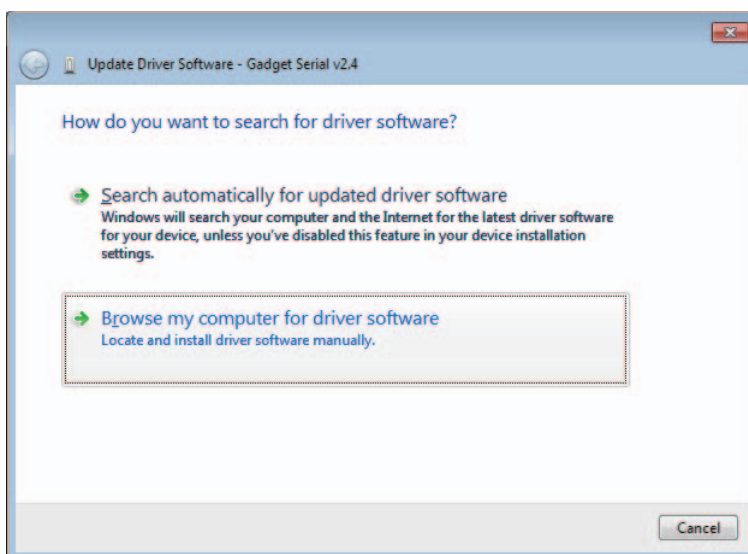

- 2** The following dialog box is displayed. Select [Include subfolders] and click the [Browse] button to specify the folder.

Specify the driver folder under NB-Designer installation directly and click [Next] button.

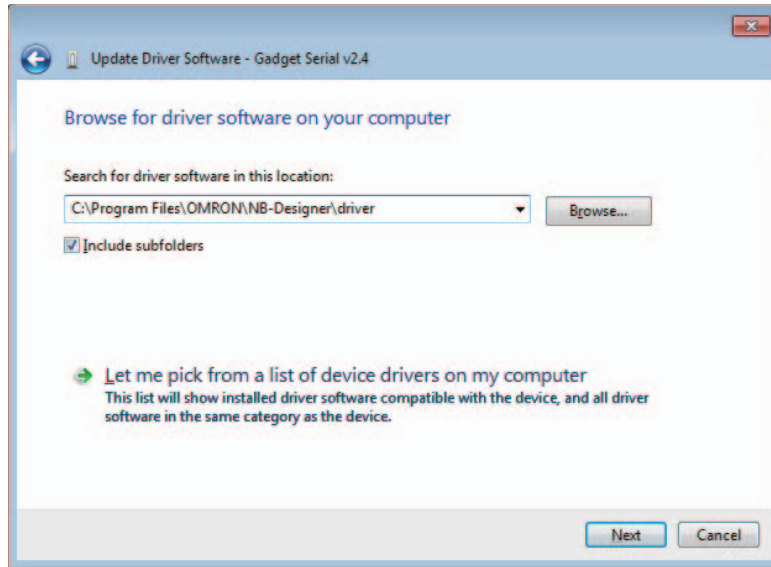

- 3** USB driver is being installed.

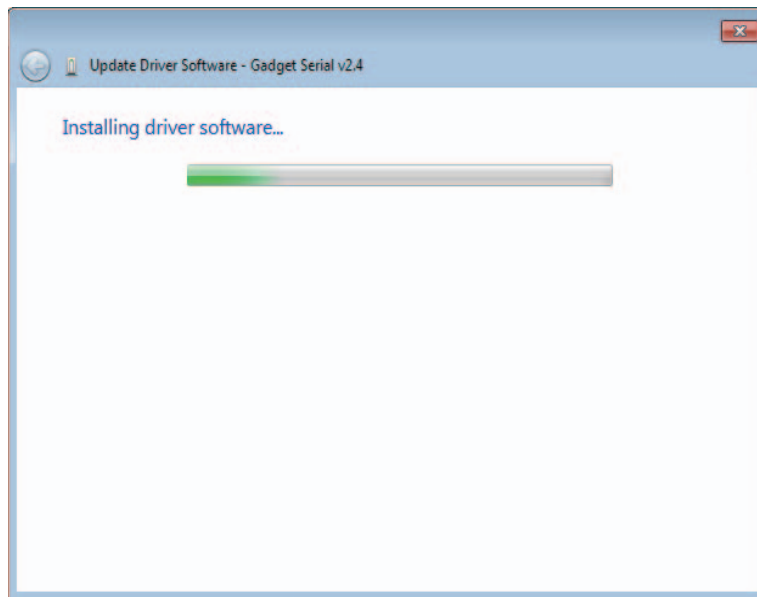

- 4** After the completion of installation, the following dialog box will appear. Click the [Close] button.

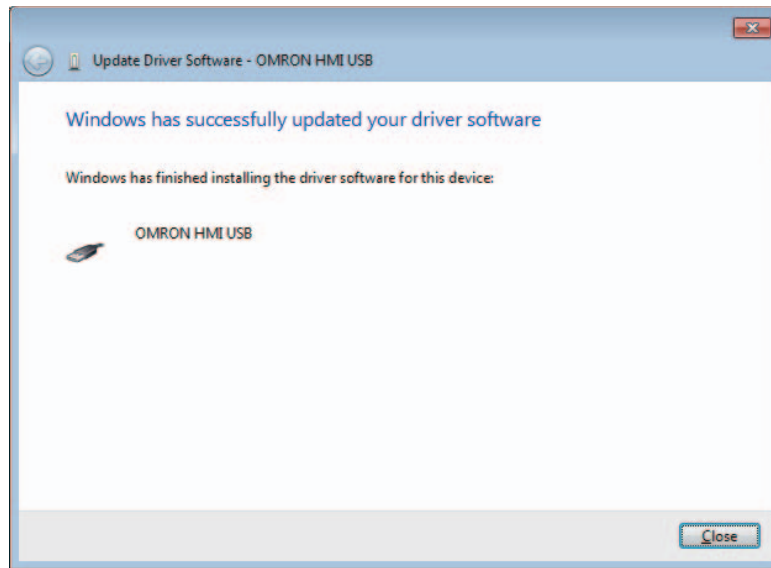

You can check whether the USB driver is installed successfully by selecting “Computer / Manage / Hardware / Device Manager / Universal Serial Bus controllers” location, as shown below.

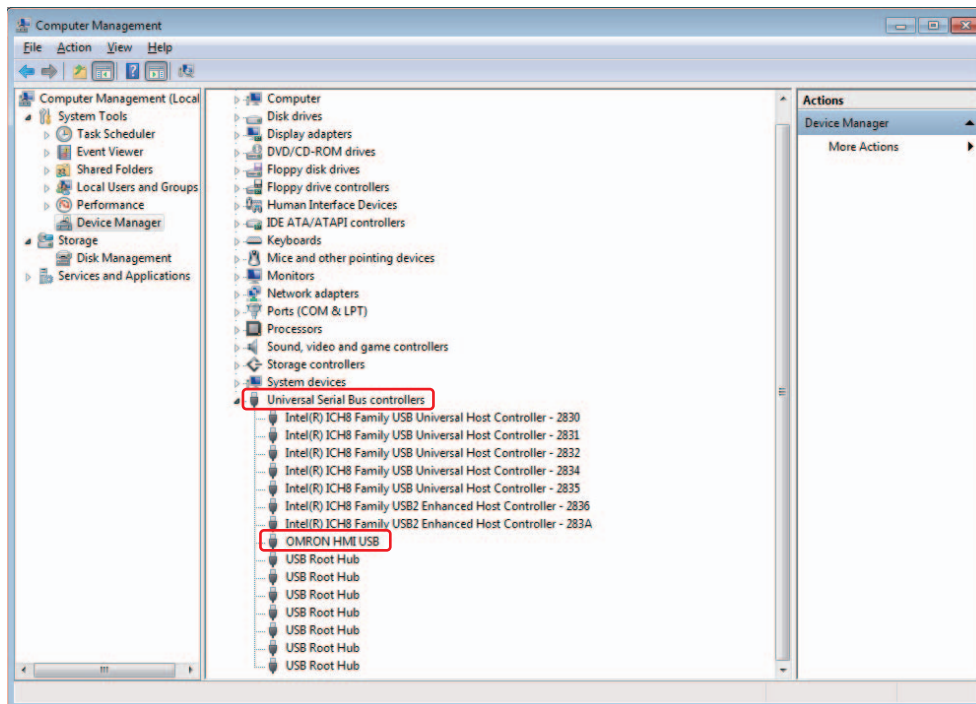

### Additional Information

When USB device is registered as Gadget Serial, it may not be installed automatically. In this case, right-click on the device manager, and select Update Driver Software from the menu, then take this step.

# 3

## Functions of NB-Designer

This section describes the functions of NB-Designer.

In this chapter, the illustrations of the functions show the NB7W-TW00B and NB7W-TW01B. Please substitute the NB7W-TW10B and NB7W-TW11B as appropriate.

---

<b>3-1</b>	<b>User Screen</b>	<b>3-4</b>
<b>3-2</b>	<b>Menus</b>	<b>3-7</b>
3-2-1	File Menu	3-7
3-2-2	Edit Menu	3-11
3-2-3	View Menu	3-16
3-2-4	Screen Menu	3-27
3-2-5	Draw Menu	3-31
3-2-6	Components Menu	3-31
3-2-7	Tools Menu	3-32
3-2-8	Option Menu	3-32
3-2-9	Window Menu	3-33
3-2-10	Help Menu	3-34
<b>3-3</b>	<b>NB-Designer Software Window</b>	<b>3-35</b>
3-3-1	Project Library Window	3-35
3-3-2	Project File Window	3-39
3-3-3	Project Work Space	3-39
3-3-4	Output Window	3-45
3-3-5	Component List Window	3-46
<b>3-4</b>	<b>Screen Concept</b>	<b>3-47</b>
3-4-1	Screen Types	3-47
3-4-2	Screen Property	3-50
3-4-3	Screen Creation	3-54
3-4-4	Screen Opening	3-54
3-4-5	Screen Deletion	3-55
3-4-6	Components Related to Screen	3-55
<b>3-5</b>	<b>Basic Design Method</b>	<b>3-56</b>
3-5-1	Designing Components	3-56
3-5-2	About ID No.	3-57
3-5-3	Additional Comments (Descriptions)	3-58
3-5-4	Read/Write Address for PLC	3-59
3-5-5	Vector Graphic	3-60

3-5-6	Bitmap	3-65
3-5-7	Creating Label	3-68
3-5-8	Task Bar and Operation Buttons	3-70
3-5-9	Fonts	3-72
3-5-10	Basic Properties of Component	3-75
3-5-11	Control Setting of Component	3-76
3-5-12	Display Setting of Component	3-80
<b>3-6</b>	<b>Parts</b>	<b>3-82</b>
3-6-1	Bit Button	3-82
3-6-2	Bit Lamp	3-85
3-6-3	Bit Switch	3-88
3-6-4	Command Button	3-89
3-6-5	Word Lamp	3-96
3-6-6	Word Switch	3-98
3-6-7	XY Graph	3-102
3-6-8	Moving Component	3-111
3-6-9	Animation	3-116
3-6-10	Number Input	3-118
3-6-11	Number Display	3-124
3-6-12	Text Input	3-127
3-6-13	Text Display	3-131
3-6-14	Level Meter	3-132
3-6-15	Analog Meter	3-143
3-6-16	Indirect Screen	3-147
3-6-17	Direct Screen	3-150
3-6-18	Alarm	3-152
3-6-19	Data Log	3-154
3-6-20	Recipe	3-164
3-6-21	Oscillograph	3-164
3-6-22	Scroll Bar	3-168
3-6-23	Event	3-171
3-6-24	Note Book	3-178
3-6-25	Word Neon Lamp	3-189
3-6-26	Bit Neon Lamp	3-190
3-6-27	Touch Trigger	3-191
3-6-28	Table	3-193
3-6-29	Data History	3-194
<b>3-7</b>	<b>Function Parts</b>	<b>3-200</b>
3-7-1	Scale	3-200
3-7-2	Function Key	3-201
3-7-3	Alarm Display	3-209
3-7-4	Timer	3-213
3-7-5	Bitmap	3-218
3-7-6	Vector Graphics	3-219
3-7-7	Notepad	3-220
3-7-8	Data Transmission	3-223
3-7-9	Freeplotting	3-226
3-7-10	Date/Time	3-227
3-7-11	Indirect Shape	3-229
3-7-12	User Information	3-233
3-7-13	Multifunction	3-233
3-7-14	Event Display	3-236

<b>3-8 Project Database</b>	<b>3-238</b>
3-8-1 Text Library	3-238
3-8-2 Variable Table	3-244
3-8-3 Alarm Setting	3-248
3-8-4 Event Setting	3-253
3-8-5 PLC Control	3-257
<b>3-9 Macro Function</b>	<b>3-265</b>
3-9-1 Create a Simple Macro Program	3-265
3-9-2 Macro and Specification of Operation with Read/Write Variables	3-272
3-9-3 Macro Triggering	3-273
3-9-4 Other Descriptions	3-276
<b>3-10 System Parameters</b>	<b>3-291</b>
3-10-1 PT	3-292
3-10-2 Task Bar	3-294
3-10-3 PT Extended Properties	3-296
3-10-4 System Information Setting	3-306
3-10-5 Security Levels Setting	3-308
3-10-6 User Permission Setting	3-310
3-10-7 Event History Setting	3-324
3-10-8 COM1 Setting	3-325
3-10-9 Ethernet Communication Setting	3-327
<b>3-11 Address of System Memory</b>	<b>3-328</b>
3-11-1 Local Bit (LB)	3-329
3-11-2 Local Word (LW)	3-334
3-11-3 Nonvolatile Local Word (LW10000~10255)	3-339
3-11-4 System Information Table	3-340
<b>3-12 Recipe Data</b>	<b>3-342</b>
3-12-1 Process of Creating One Recipe Component	3-342
3-12-2 Recipe Memory	3-344
3-12-3 Upload/Download of Recipe Data between PT and PLC	3-348
<b>3-13 Security Level</b>	<b>3-353</b>
<b>3-14 Test</b>	<b>3-359</b>
3-14-1 Offline test	3-359
3-14-2 Direct Online test	3-360
3-14-3 Indirect Online test	3-361
<b>3-15 Download</b>	<b>3-362</b>
3-15-1 Transmission Setting	3-362
3-15-2 Download via USB Memory	3-365
3-15-3 Specification of Downloading Contents	3-365
<b>3-16 Other Functions</b>	<b>3-369</b>
<b>3-17 RecipeEditor</b>	<b>3-418</b>

## 3-1 User Screen

The displayed contents in the screen are shown as below when the NB-Designer is running. You can also right-click [View] - [Toolbar] or toolbar to see each toolbar shown as below.

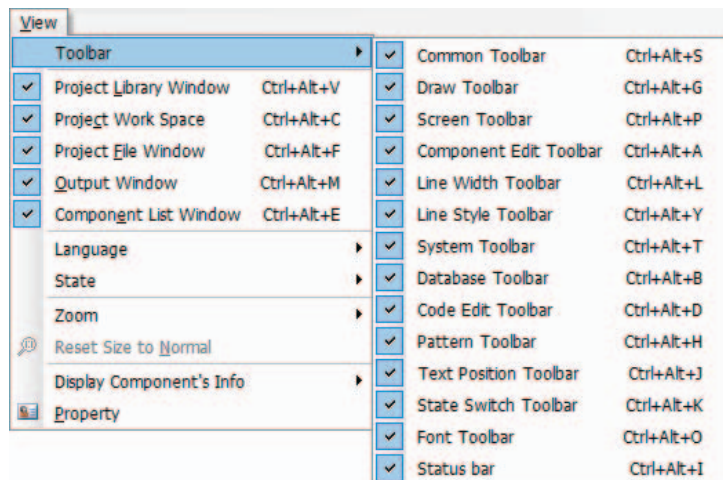
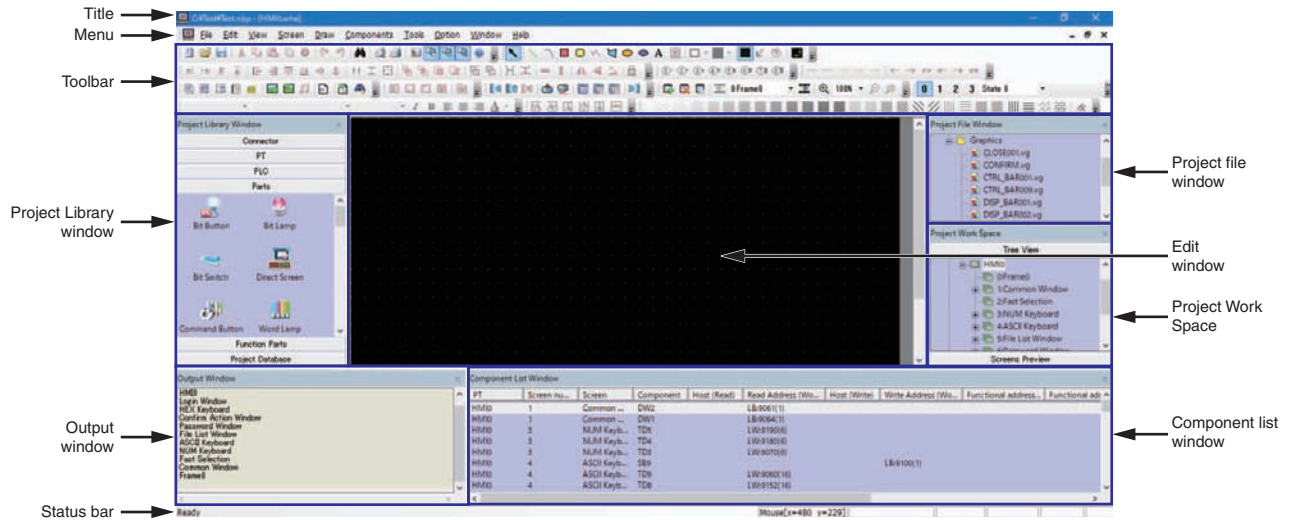

### ● Title

Editing project file name and others are displayed.

### ● Menu

Selects the various kinds of command menus of NB-Designer. After these menus being selected, the corresponding pull-down menu will pop up. Each pull-down menu corresponds to one command operation.



## ● Toolbar

### **1 Common Toolbar**

Includes some basic tools such as “New”, “Open”, “Cut” and “Copy” etc.

### **2 Draw Toolbar**

Each image of figure drawing is displayed in icons. The available drawing tools include Line, Rectangle, Ellipse, Sector, Polygon, Text etc.

### **3 Screen Toolbar**

Performs Up/Down operation of the screen.

### **4 Component Edit Toolbar**

Adjusts the position of the component (i.e. top-alignment, bottom-alignment, left-alignment, right-alignment etc), the size, cascading, combination and flip methods.

### **5 Line Width Toolbar**

Adjusts the width of the line in the figure.

### **6 Line Style Toolbar**

Add or delete the arrow head, replace solid line with broken line in the figures.

### **7 System Toolbar**

Performs the compilation, downloading and test of the project.

### **8 Database Toolbar**

Includes text library, alarm information, Variable Table, PLC control and event information.

### **9 Code Edit Toolbar**

The icon to edit macro is displayed.

### **10 Pattern Toolbar**

Select the filling-style of screen background or the closed space such as rectangle, ellipse, sector etc.

### **11 Label Component Edit Toolbar**

Performs the alignments of the label such as label aligning to the left-border/right-border/top-border or bottom-border of the component, label locating in the vertical center or horizontal center of the component.

### **12 State Switch Toolbar**

Simulates the switching of the various states of each component in the current screen and languages.

### **13 Font Toolbar**

Sets dot matrix/vector/graphics mode, font and font size of various kinds of texts displayed in the screen.

## **14** Status Bar Toolbar

Displays the information such as the current mouse position, the width/height of the destination object and the editing state etc.

### ● **Project Library Window**

6 columns in the Project Library Window are available.

Connector: Selects the communication cable type.

PT: Selects the PT type.

PLC: Selects the PLC type.

Parts: Selects various kinds of configuration parts.

Function Parts: Selects various kinds of multi-function parts.

Project Database: Selects some special functions.

### ● **Project Work Space**

Project Work Space adopts tree view chart to show the relations of the PLC, PT, PT internal screens and components in the whole project.

### ● **Project File Window**

Project File Window adopts tree view to show the correlations between the PT and bitmap files related to the project, and all the information of the files (such as the recipe files, macro files and graphics library files etc) contained in the project.

### ● **Output Window**

For details, refer to *3-3-4 Output Window (Page 3-45)* in *NB-Designer Operation*.

### ● **Component List Window**

For details, refer to *3-3-1 Project Library Window (Page 3-35)* in *NB-Designer Operation*.

### ● **Configuration and Setup Window, Edit Window**

Users setup configurations or create drawings in the window.

## 3-2 Menus

There are various kinds of menus in NB-Designer. You can set the object, graphics, chart, macro, data block etc, and create the screen data displayed on the NB Unit. The pull-down menu list and the purposes of each item are as follows.

### 3-2-1 File Menu

#### ● New

Select [New] in the [File] menu or  icon to create a new project.

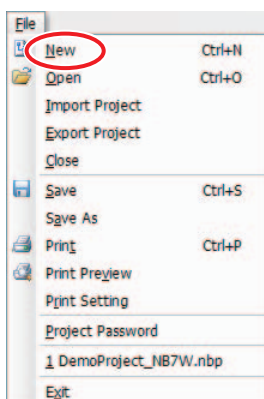

A new project is created when you press [OK] after inputting the project name.

#### ● Open

Select [Open] in the [File] menu or  icon to open an existing project.

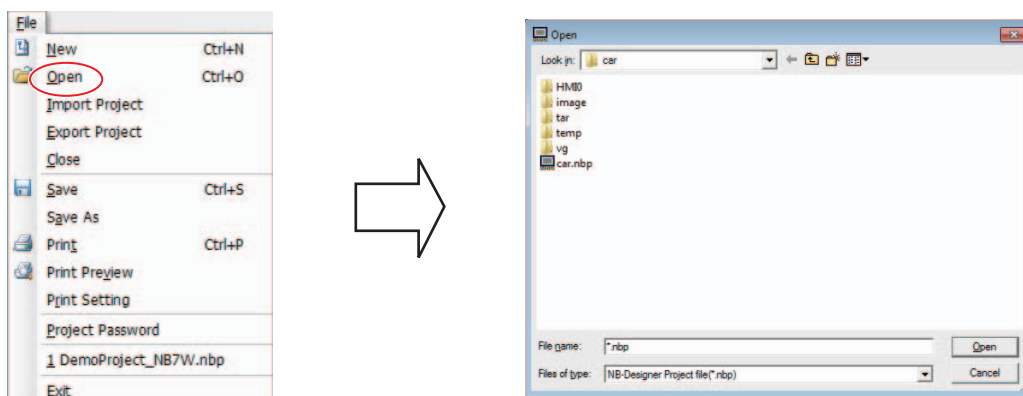

Select the project file to be opened, and press [Open] or double click this project file.

● **Import Project/ Export Project**

Select [Export Project] in the [File] menu to save an opened project as a pkg file. Select [Import Project] in the [File] menu to import an existing pkg file.

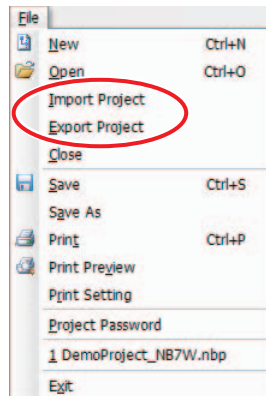

● **Save**

Select either of "Save" and "Save As".

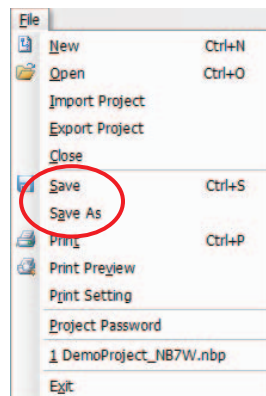

● **Print**

Select a project data and open a screen to enable this function. This functionality will allow the user to print screen images.

Click [Print] to open print setup window.

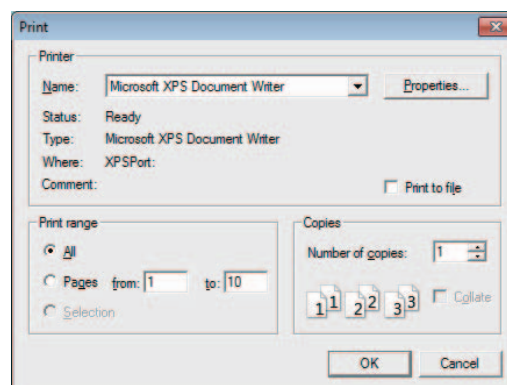
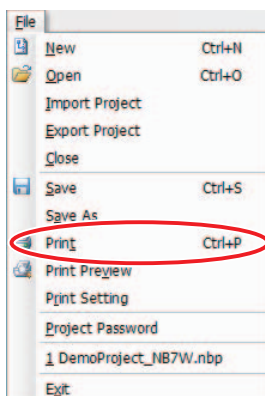

Select [Print Preview] to display a preview window.

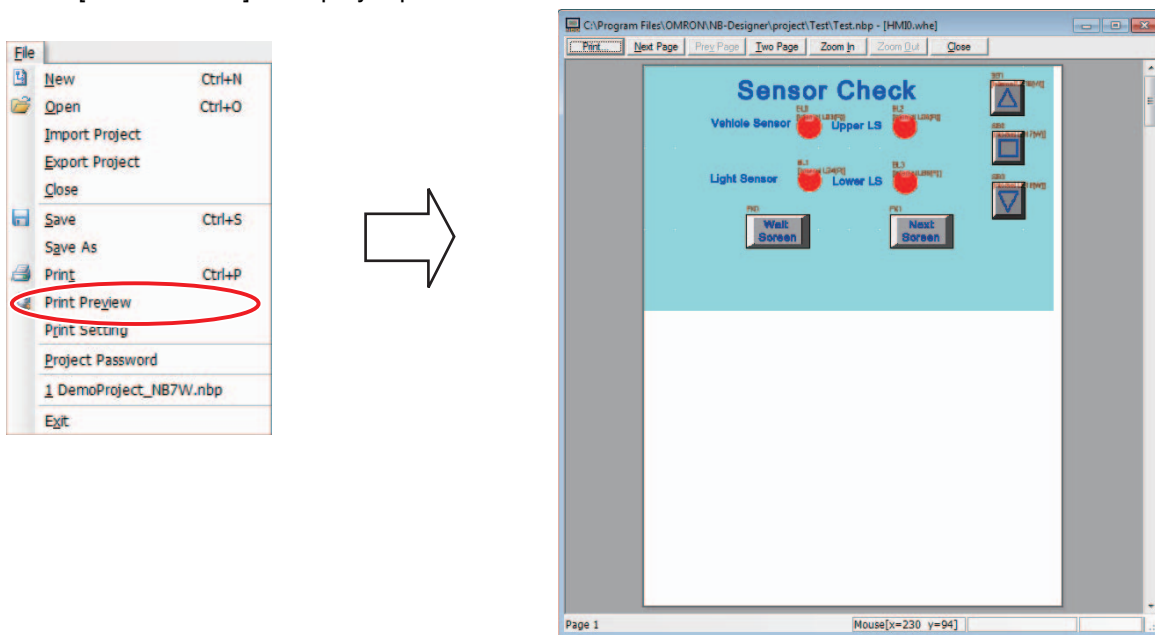

To display the Print Setup window, click [Print Setting].

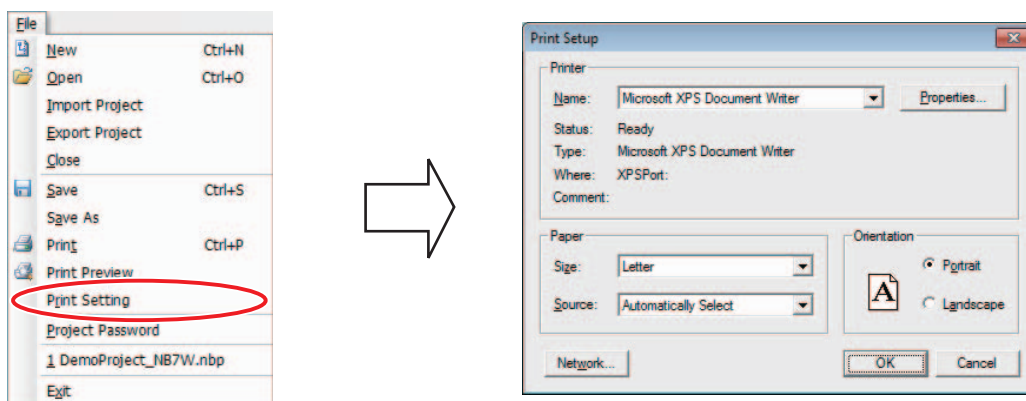

● **Close**

Select [Close] in the [File] menu to close the current project.

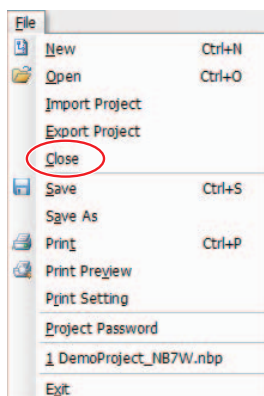

All the current windows will be closed after “Close” being pressed, and the display screen is shown as below.

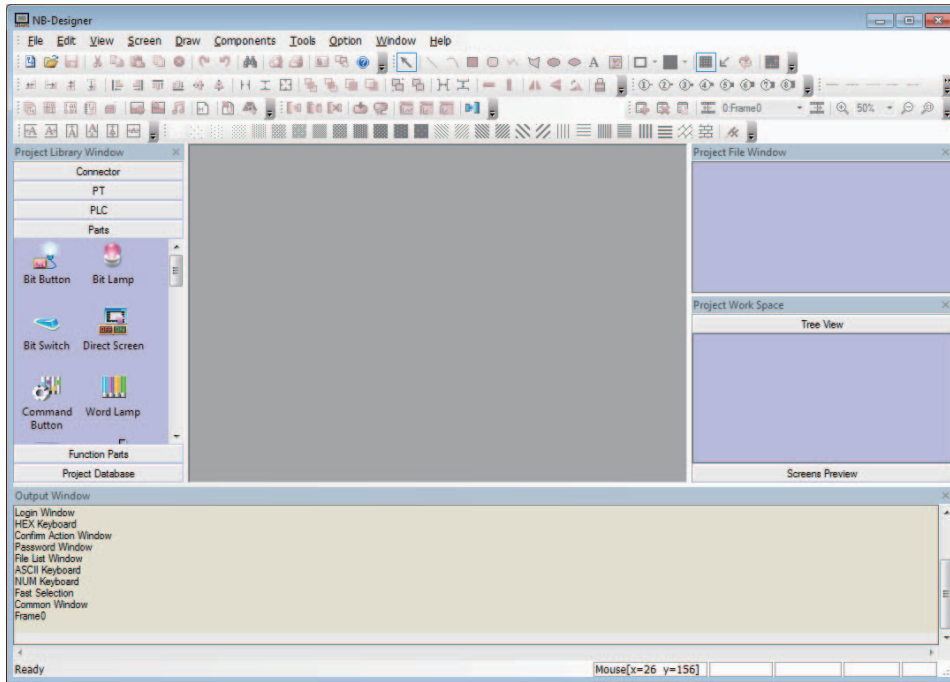

- List up the 4 projects opened recently

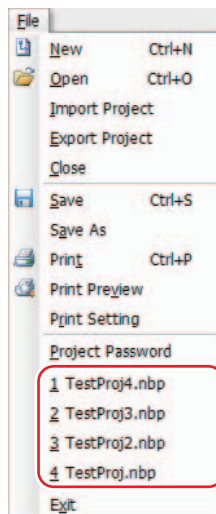

- Exit

Exit the NB-Designer software.

**Note** When Free-editing multiple project screens, adds the multiple-project-simultaneous-opening function, thus making the copy of the component in the editing screens of two projects available.



#### Additional Information

Operations related to files cannot be executed via networks.

Do not use the system locale-dependent characters for the project file name and folder name.

## 3-2-2 Edit Menu

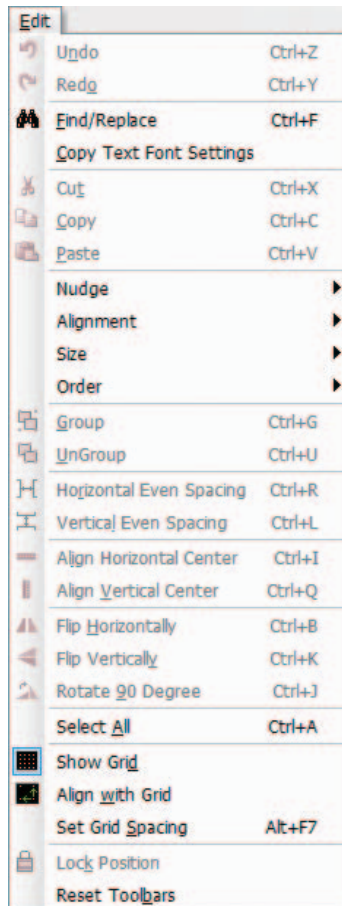

### ● Undo

The latest operation can be cancelled by using this function, and the screen will return to the state before this operation. Pressing  icon or selecting [Undo] in the [Edit] menu can cancel the latest operation.

### ● Redo

Using this function after performing “Undo” operation can restore the “Undo” operation done just now. It just needs to press  icon or select [Redo] in the [Edit] menu.

The operations supported by “Undo” and “Redo” are as follows.

- (1) Dragging a part or a functional part from the Project Library Window
- (2) Drawing a component
- (3) Moving the object
- (4) Adjusting the object size
- (5) Performing all the operations with the Component Edit Toolbar
- (6) Selecting the line width, line style or arrow
- (7) Selecting the object filling style
- (8) Selecting the object border color
- (9) Selecting the object filled color
- (10) Performing “Set Top Layer” and “Set Bottom Layer” operations
- (11) Performing cut, copy, paste and deletion

(12)Performing the Repeat operation

An example of operation in which a bit switch component is added to the PT screen and [Undo] or [Redo] is performed to the addition is provided as below.



Press [Undo].



Then press [Redo].

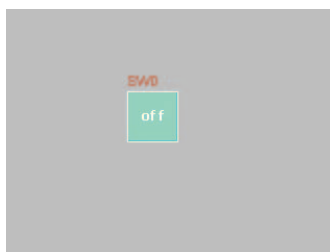

**Note** The software only supports single-step “Undo/Redo” operation.

● **Cut, Copy, Paste and Delete**

After selecting one component or more, you can cut, copy, paste it or them etc, and the corresponding icons are shown as  .

● **Nudge**

The component position can be adjusted by “Nudge” method after it is selected. The component movement can be realized by using direction key or the corresponding [Nudge] icons. Each time the “Nudge” button is pressed, the component will move a pixel distance accordingly. The

corresponding icons are shown as  and they are “Left”, “Right”, “Up”, “Down”

corresponding one-to-one with the contents of [Nudge] in the [Edit] menu. The simple nudge method is to use the arrow keys on the keyboard, which realizes the easy component movement.

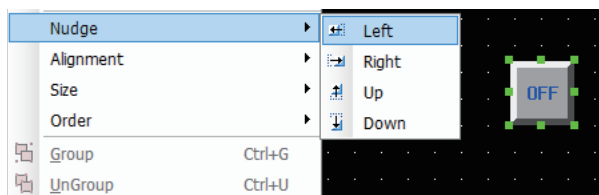



● **Alignment**

Makes the selected component realize the Left, Right, Top, Bottom, Vertical Midline or Horizontal Midline alignment. The corresponding icons are shown as Here  only take “Left” as an example with the effect shown as below.

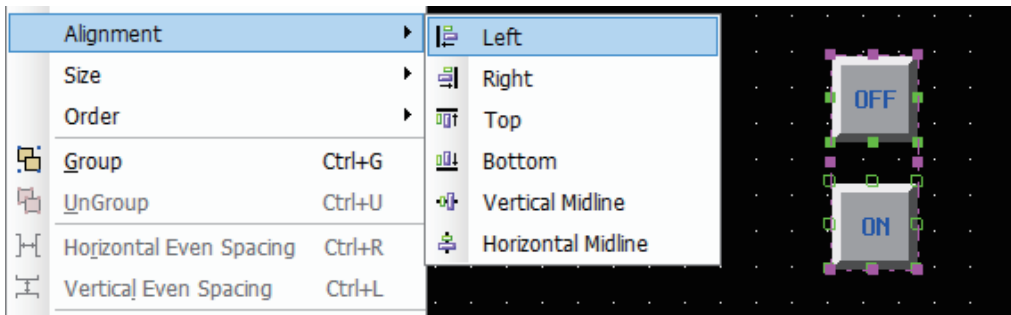
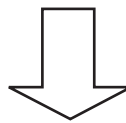
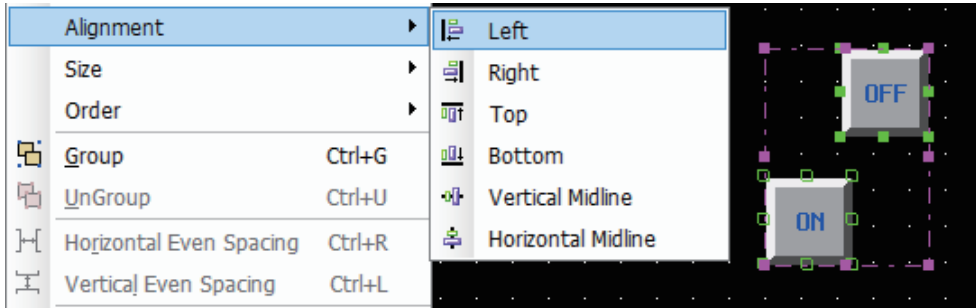

● **Size**

To make the multiple components with the same width, height or size, you just need to press the corresponding icons for adjusting the size of the component, or to select the options in the corresponding menus. The corresponding icons are shown as  and they are “Width”, “Height” and “Both” respectively. Unify the size for all components according to the size of the component is located in the left end among all the components. If you want to specify a certain component as the reference, select other components after pressing the [shift] key to select the reference.

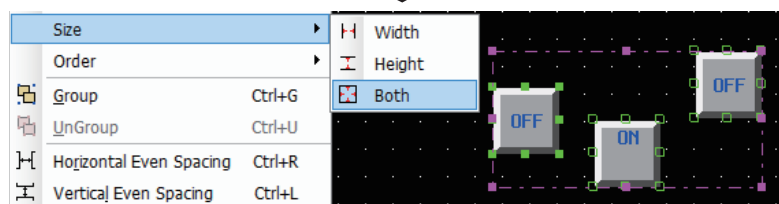
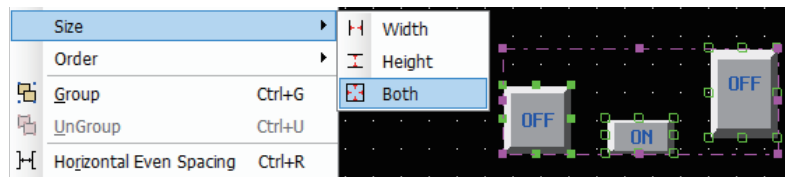

● **Order**

When the multiple components are overlapped together, you can use the icons shown as





(Bring to Front, Send to Back, Bring Forward, Send Backward) or select [Bring to Front], [Send to Back], [Bring Forward], [Send Backward] in [Order] of the [Edit] menu to change the display order of the components.

Firstly select the component and set the layer of the component by pressing the corresponding icon. The component in the front layer is always displayed above that in the back layer.



● **Group/UnGroup**

This function is used to make the multiple selected components or graphics combined together as a separate component. To make multiple components combined together, it just needs to select these components, and then select [Group] in the [Edit] menu or press  icon. To cancel the combination, it only needs to select this combined component, then select [UnGroup] in the [Edit] menu or press  icon.

● **Horizontal Even Spacing**

This function is used to make the horizontal space between the multiple selected components or graphics same. Select the graphics or components to be operated, and then select [Horizontal Even Spacing] in the [Edit] menu or press  icon. Clicking the icon allows the components lined as below.



● **Vertical Even Spacing**

This function is used to make the vertical space between the multiple selected components or graphics same. Select the graphics or components to be operated, and then select [Vertical Even Spacing] in the [Edit] menu or press  icon.

### ● Align Horizontal Center

This function is used to make the multiple selected components or graphics located in the horizontal center of the Edit Window. Firstly select the components or graphics to be operated, and then select [Align Horizontal Center] in the [Edit] menu or press  icon, as shown below.

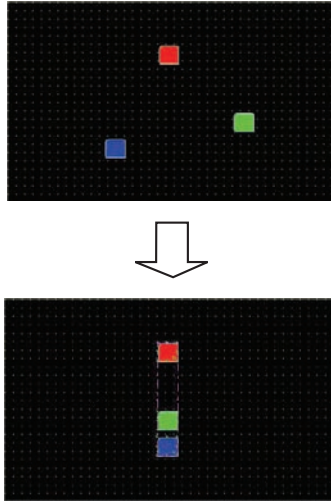

### ● Align Vertical Center

This function is used to make the multiple selected components or graphics located in the vertical center of the Edit Window. Firstly select the graphics to be operated, and then select [Align Vertical Center] in the [Edit] menu or press  icon.

### ● Flip

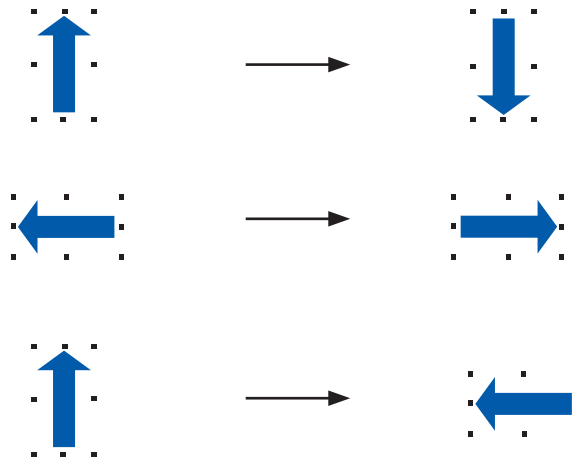

Only shapes (such as line, circle, polygon etc) drawn by drawing tools rather than other components can be flipped. Firstly select the graphics to be operated, and then select [Flip Horizontally], [Flip Vertically], [Rotate 90 Degree] in the [Edit] menu or select the corresponding  icons to flip the components.

#### ● Reset Toolbars

When the toolbar is moved to the other position, it can be restored to the default position by clicking this option, as shown below.

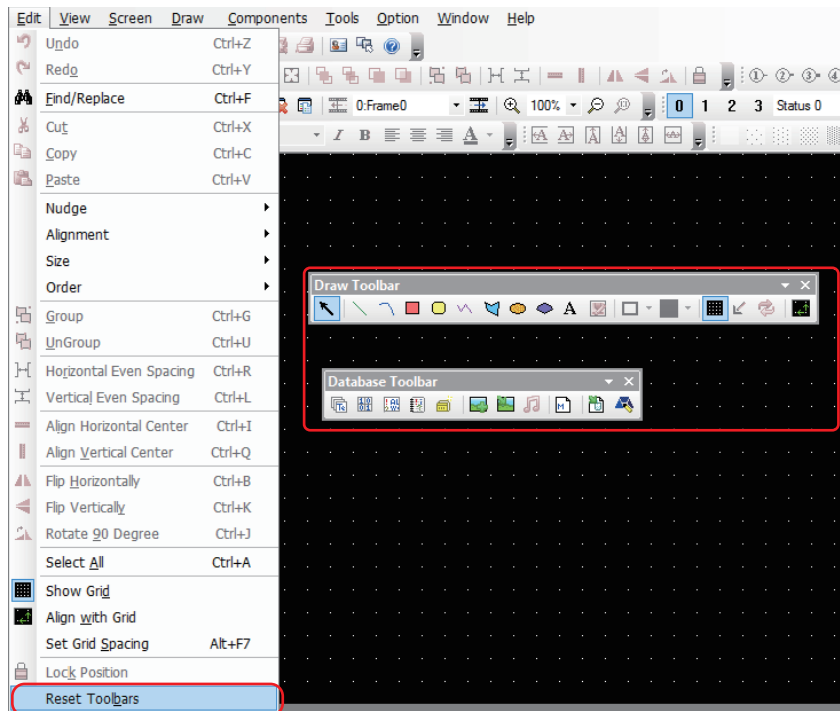

### 3-2-3 View Menu

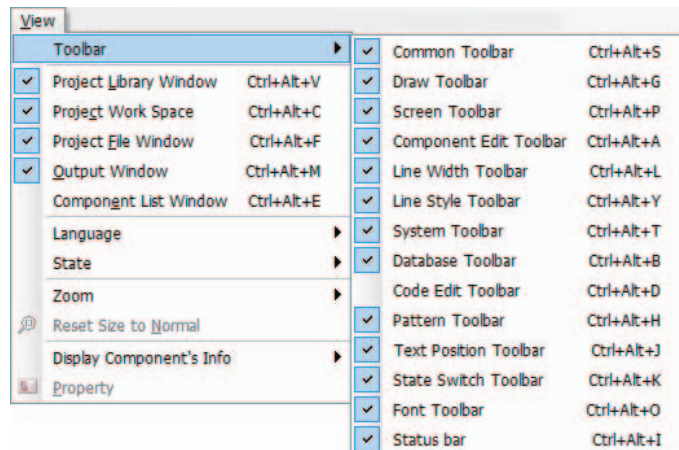

The options in the [View] menu are used to control the various kinds of toolbars to be displayed or not.

### ● Common Toolbar

The correspondences of all the items (i.e. the icons here) in the standard toolbar to the options in the menus are shown as below.

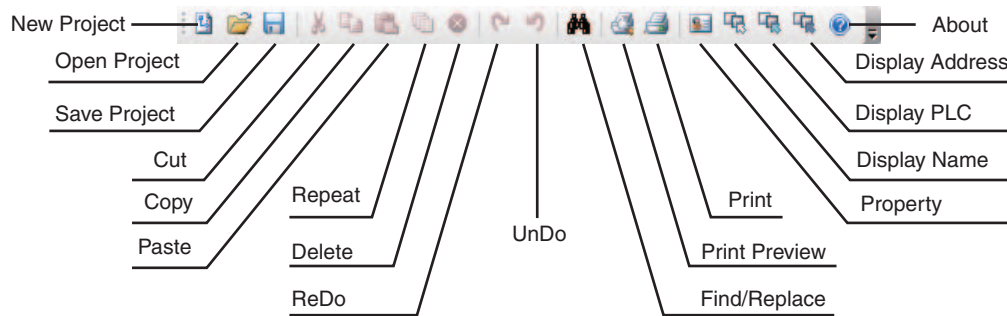

[New Project]: To create a new project

[Open Project]: To open an existing project

[Save Project]: To save the current project

[Cut]: To perform cutting operation

[Copy]: To perform copy operation

[Paste]: To perform paste operation

[Repeat]: To perform Repeat operation

[Delete]: To delete the component

[Redo]: To restore the latest cancelled operation

[Undo]: To cancel the latest operation procedure

[Find/Replace]: To search the memory addresses used in the current project, screen or macro and perform the replacement

[Print Preview]: To preview the print effect

[Print]: To print

[Property]: To show the object Properties

[Display Name]: To display/hide the component's name

[Display PLC]: To display/hide the component's PLC name

[Display Address]: To display/hide the component's address

[About]: To describe the version information of NB-Designer

## ● Repeat

With this function, one component can become multiple components through the copy operation, thus saving a lot of time. You can make the multiple components available by clicking  icon or right-clicking [Repeat] in the corresponding menu after the component being selected, as shown below.

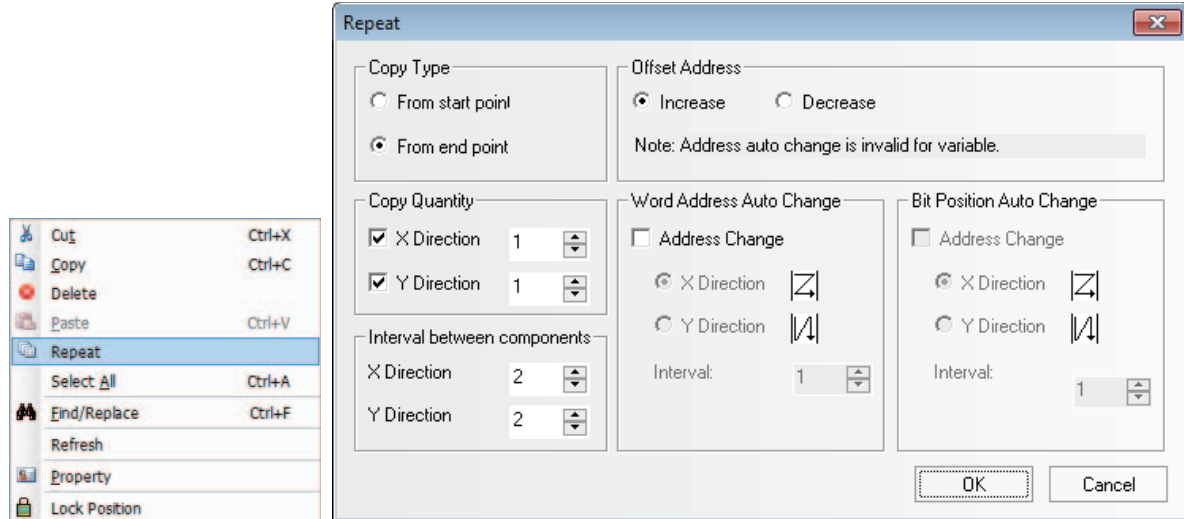

**Copy Type:** Selecting [From start point], the copied component to be arranged according to the upper left top of the component as the reference point.

Selecting [From end point], the copied component to be arranged according to the lower right top of the component as the reference point.

**Copy Quantity:** The number of the copied component in each line and each column.

**Interval between components:** Specifying the horizontal interval and vertical interval between the two of the copied components.

**Offset Address:** The address of the copied component increases/decreases in X, Y directions.

**Word Address Auto Change:** The word address of the copied component increases/decreases in X, Y directions.

**Bit Position Auto Change:** The bit address of the copied component increases/decreases in X, Y directions.

**Interval:** To select the address increment among the copied components.

[Property]: When changing the property of the components, select and double-click the component which is necessary to change the property. Also clicking the  icon and displaying [Property] dialog box allow the property of the component edited.

● **Database Toolbar**

The correspondences of all the items (i.e. the icons here) in the toolbar to the options in the menus are shown as below.

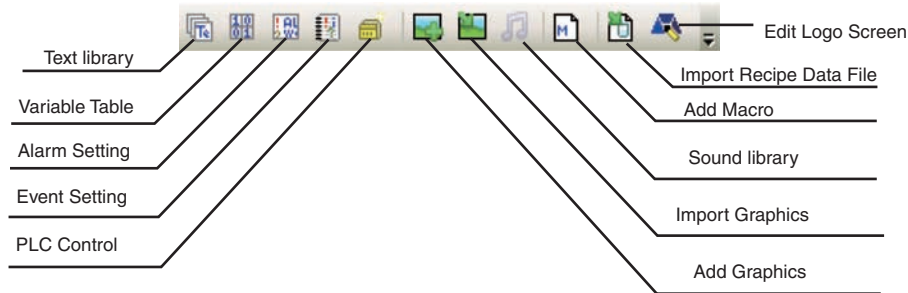

[Text Library]: To register the text string for the labels.

[Variable Table]: To register the variable information

[Alarm Setting]: To memory the alarm information

[Event Setting]: To memory the event information

[PLC Control]: To register the PLC control configurations

[Add Graphics]: To create the new bitmap or Vector Graphics

[Import Graphics]: To import the bitmap or Vector Graphics

[Sound Library]: To add the audio file (The NB-S series does not support the function.)

[Add Macro]: To add the Macro

[Import Recipe Data File]: To import the recipe file

[Edit Logo Screen]: Click this button to make the screen switch to the logo edit screen. therefore you can make modification or editing the logo screen displayed when the PT is powered on, as shown below.

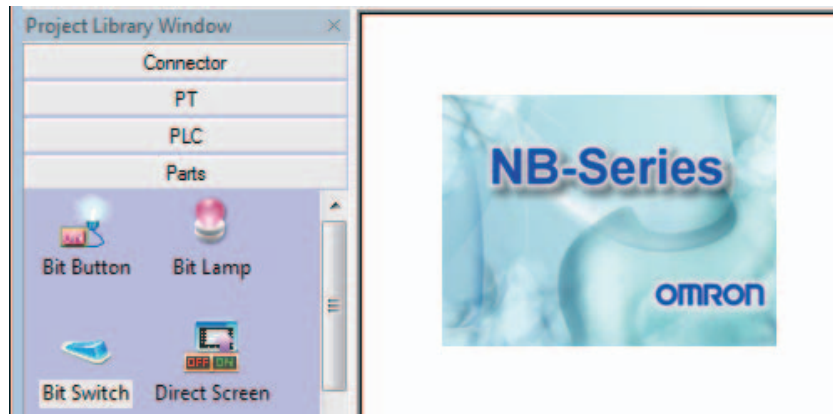

● **Line Style Toolbar**

Adding or deleting the arrow head or replacing solid line with broken line.



### ● Component Edit Toolbar



- [Nudge Left]: To make the component move left by 1 grid
- [Nudge Right]: To make the component move right by 1 grid
- [Nudge Up]: To make the component move up by 1 grid
- [Nudge Down]: To make the component move down by 1 grid
- [Align Left]: To make the multiple components left-aligned
- [Align Right]: To make the multiple components right-aligned
- [Align Top]: To make the multiple components top-aligned
- [Align Bottom]: To make the multiple components bottom-aligned
- [Align Horizontal Midline]: To make the multiple components horizontal-midline-aligned
- [Align Vertical Midline]: To make the multiple components vertical-midline-aligned
- [Equal Width]: To make the multiple components with the same width
- [Equal Height]: To make the multiple components with the same height
- [Equal Size]: To make the multiple components with the same size
- [Bring to Front]: To bring the component to top layer
- [Send to Back]: To send the component to bottom layer
- [Bring Forward]: To bring the selected component to previous layer
- [Send Backward]: To send the selected component to next layer
- [Group]: To make the multiple components combined together
- [UnGroup]: To cancel the combination of the multiple components
- [Horizontal Even Spacing]: Arranging the multiple components in a horizontal row with equal interval each by the middle point as reference point.
- [Vertical Even Spacing]: Arranging the multiple components in a vertical row with equal interval each by the middle point as reference point.
- [Align Horizontal Center]: To make the center(s) of one component or multiple components located in the horizontal center of the PT Edit area
- [Align Vertical Center]: To make the center(s) of one component or multiple components located in the vertical center of the PT Edit area
- [Flip Horizontally]: To perform horizontal flip
- [Flip Vertically]: To perform vertical flip
- [Rotate 90 Degree]: To rotate the component 90 degree clockwise
- [Lock Position]: To lock the position of the component

### ● Label Component Edit Toolbar



Click the component, and then click the label displayed later to select it. Later when you see the label is not gray any more, you can set the position of the label as required (e.g. Left Label, Right Label, Top Label, Bottom Label, Vertical Middle Label and Horizontal Middle Label).



## ● Draw Toolbar



The contents of the items in the Draw Toolbar are shown as below.

[Select]: To select one component or multiple components

[Line]: To draw a line

[Arc]: To draw an arc

[Rect]: To draw a rectangle

[Round Rect]: To draw a rounded rectangle

[Polyline]: To draw a consecutive line

[Polygon]: To draw a polygon

[Ellipse]: To draw a circle or ellipse

[Sector]: To draw a sector

[Text]: To add the text

[Load Graphic]: To add the bitmap in the editing window

[Frame Color]: To set the frame color for the shapes

[Background Color]: To set the background color for the shapes

[Show Grid]: To make the grid displayed in the screen

[Transparent Color]: To add transparency to the added bitmap

[Multicolor-Grayscale Switch]: To make the transformation between the color and black/white

[Align with Grid]: After the component being selected, click this button once to make the grid point as the moving unit, and click it twice to restore the default pixel point as the moving unit of the component.

For the color setup, there are 40 kinds of colors available, as shown below.



Besides the 40 kinds of colors shown above, the custom colors are also available. The following dialog box will be displayed after clicking "Custom Color..." at the bottom.

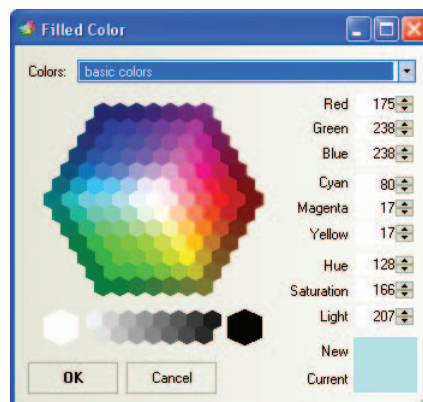

Here you can select any color you want to have. In addition, there are also several color Properties, as shown below, available to you.

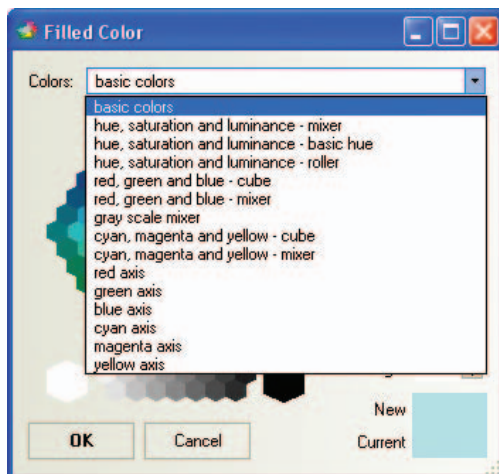

● **Select Component**

The selection methods of the components are as follows.

- (1) Direct selection: The component can be selected by using the mouse directly to click it.
- (2) Selecting all the components: All the components in the current screen can be selected by using [Select All] in the [Edit] menu.
- (3) The multiple components can be selected by clicking them consecutively while pressing the [Shift] key.

**Note** The copy operation can be performed by clicking the component to be copied while pressing the [Ctrl] key.

● **Modify Component Size**

The modification of the component size can be made by clicking the component. The specific method is as follows: select any one of the eight green points on the component, as shown below, after the component being selected, and then drag it by using the mouse.

**Note** The white dots displayed on the component mean that the text is selected. If you should change the size of component, click the area without a text to select whole the component.



● **Fill Component and Frame**

To change the frame or the background color of the shapes, it just needs to click the small arrow behind the  "Frame Color" icon after the component being selected to change the frame color, and to click the small arrow displayed in the right to the [Background Color] icon change the background color of the shapes, as shown below.

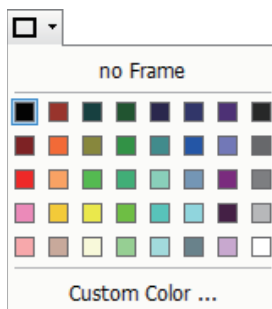

## ● Text

After the text icon  being pressed, the text dialog box will pop up, as shown below.

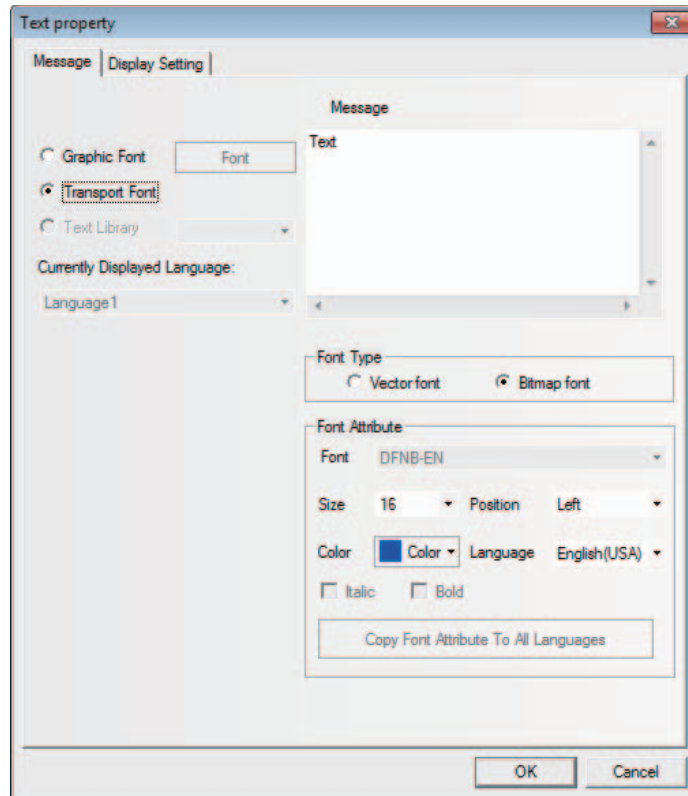

**Message:** Enter the text which will be displayed on the component. You can use the “Enter” key to break the input text.

**Graphic Font:** The font and its size and style etc can be modified in this mode. The Modify dialog box, as shown below, can be entered by clicking the “Font” on the right side of “Graphic Font”.

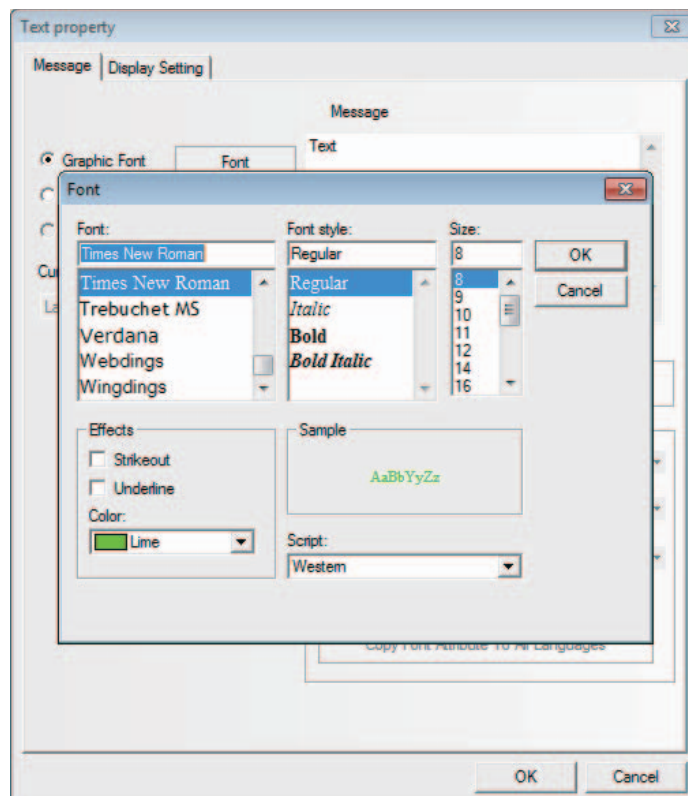

**Transport Font:** In this mode, both Vector Font and Bitmap Font can be used, and the font size, alignment method or color etc can be changed.

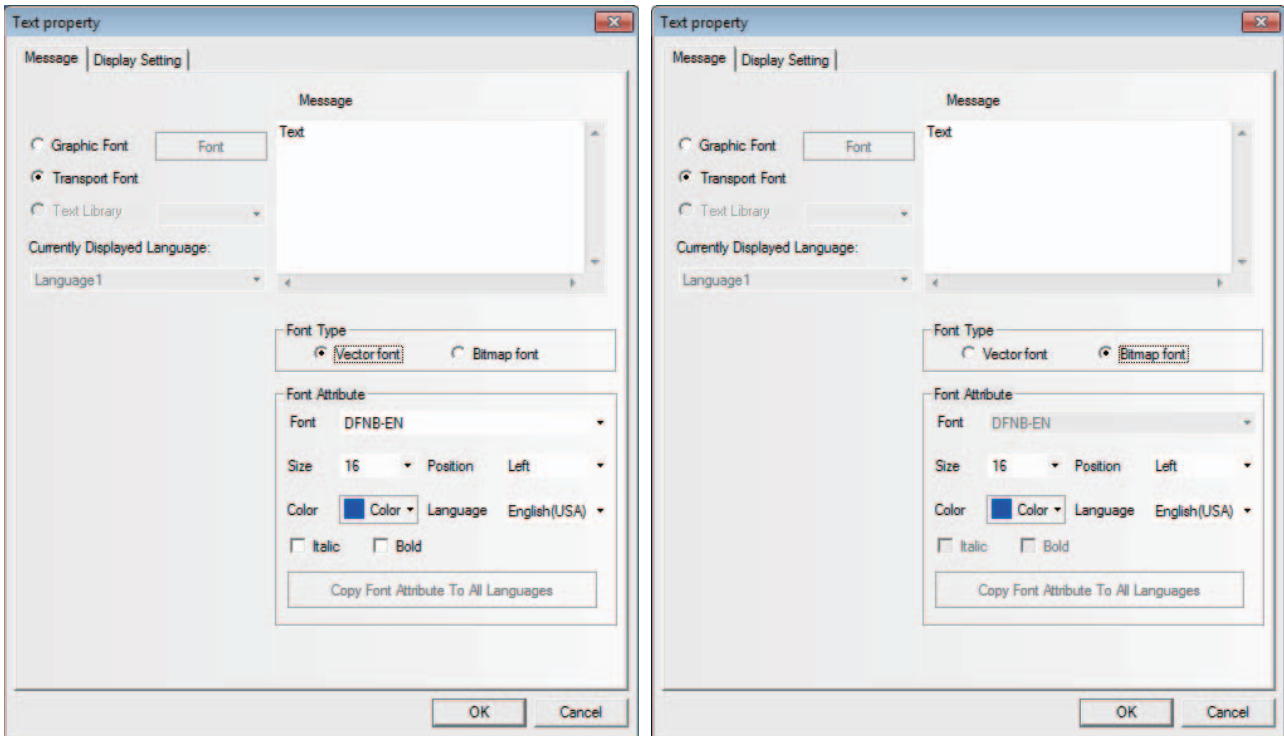

#### ● Load Graphic

The  icon can be used to add the graphic when you create a new bitmap. For the creation of the bitmap, refer to *3-5-6 Bitmap (Page 3-65)* in *NB-Designer Operation*.

#### ● Screen Toolbar



[Add Screen]: To add the Edit Window

[Delete Screen]: To delete the current Edit Window

[Current Screen Property]: To display the Properties of the current Edit Window

[Previous Page]: The previous Edit Window

[Current Page]: The title of the current Edit Window

[Next Page]: The next Edit Window

[Magnify]: To magnify in the current Edit Window

[Zoom]: 100%, 200%, and 300% available

[Dwindle]: To dwindle the current Edit Window

[1:1]: The current Edit Window displayed in 100%

#### ● Line Style Toolbar

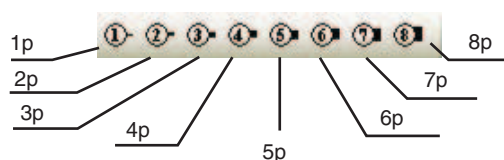

They are used for the selection of line width

## ● System Toolbar



[Compile]: To only compile the parts with changes in the current project and to check whether there is an error or not. The project must be compiled before the download or test. otherwise the download or test will fail.

[Recompile]: To recompile the items in the current project

[Clear Compiled Result]: To clear the result of the current project

[Download]: To download the project into PT

[Transmission Setting]: To set the transmission method. Either of the Ethernet, USB port, or serial port can be set.

[Offline test]: To perform offline test of the project

[Indirect Online test]: To perform online test of the project indirectly

[Direct Online test]: To perform online test of the project directly

[Decompile]: To decompile the project

## ● Code Edit Toolbar

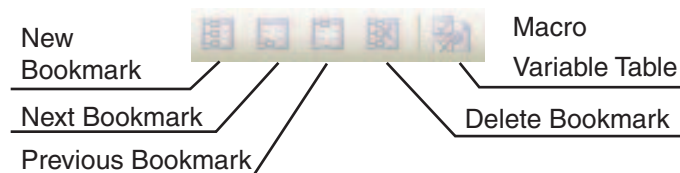

[New Bookmark]: To create a new bookmark

[Next Bookmark]: To check the next bookmark

[Previous Bookmark]: To check the previous bookmark

[Delete Bookmark]: To delete the bookmark

[Macro Variable Table]: To open or close the Macro Variable Table

## ● Status Bar Toolbar



Displays the information such as the current mouse position, the width/height of the destination object and editing state etc.

## ● Pattern Toolbar



Select one fill effect among various styles as above to set to the drawing components or Edit Window.

In order to set the fill effect to the displayed window, double-click the window and check “Use Background Color” in the displayed “Screen Property”, as shown below.

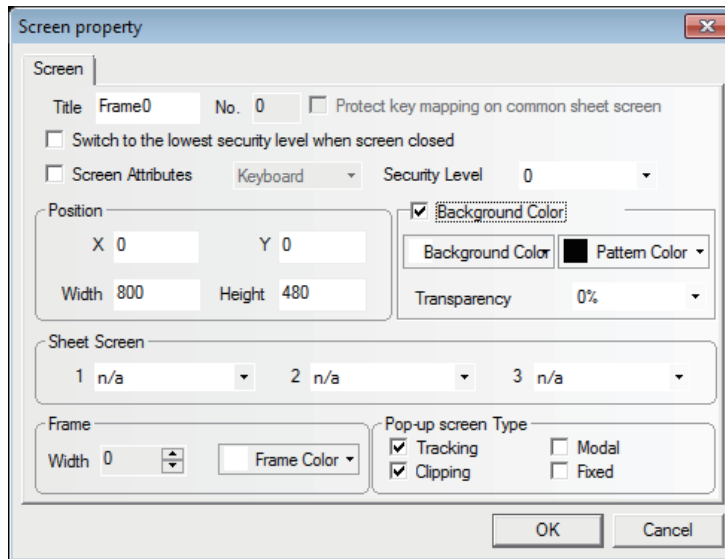

Then select the pattern color and the background color as well as the fill effect you want, as shown below.

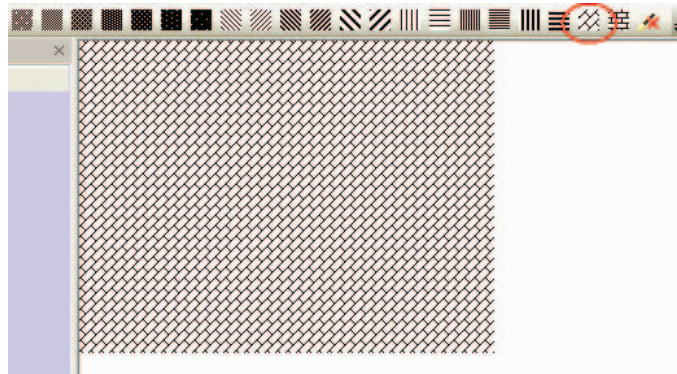

In order to add fill effect to the shapes, select the shape to add fill effect and select the fill effect. The procedure to set the fill effect is the same as the one for adding fill effect to the PT. But when setting the fill effect to the components, [Pattern Color] is applied to the outline color and [Background color] is applied to the component's color. The parameters set to the shape is reflected as below.

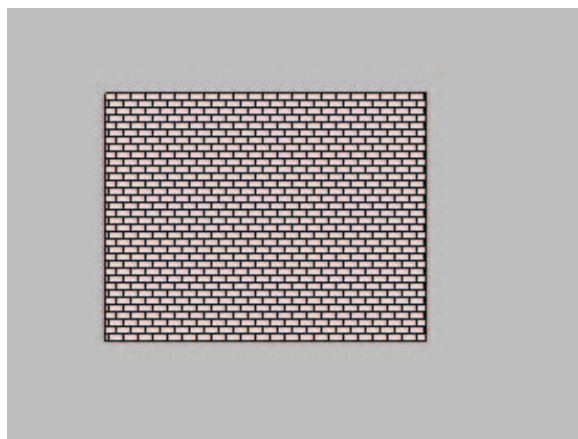

### 3-2-4 Screen Menu

The corresponding contents in the [Screen] menu shown as below have been described in [3-2-3 View Menu], here only the function of [Copy/Delete Screen] and [Save Screen Image] are described in details.

#### ● Copy / Delete Screen

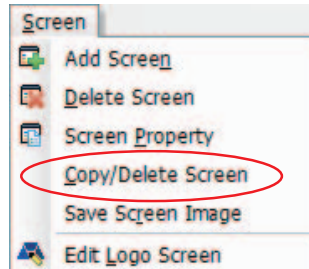

Click [Screen]→[Copy/Delete Screen], and the following dialog box will be displayed.

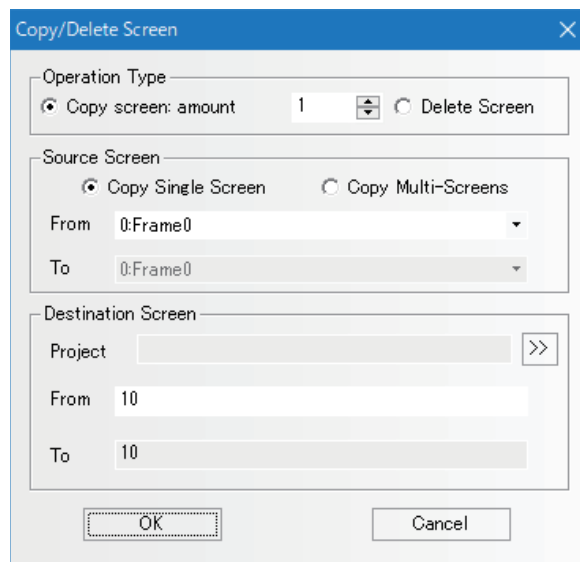

#### ● Operation Type

##### (1) Copy Screen

It can be one or more and its range is between 1 and 999.

##### • Copy Single Screen

When the number is 1, both the starting source screen ID and the starting destination screen ID can be set, which means the screen and Properties of the source screen will be copied into the destination screen.

If the destination screen doesn't exist, the screen with a specified number will be created automatically after the copy operation. And if the destination screen exists already, "Copy error: the destination screen ID already exists!" will prompt.

When the number is greater than 1, both the starting source screen ID and the starting destination screen ID can be set, and the destination screen ID will increase automatically according to the copied number in this case, which means the screen and Properties of the source screen will be copied into the screens between the starting destination screen and the end destination screen respectively.

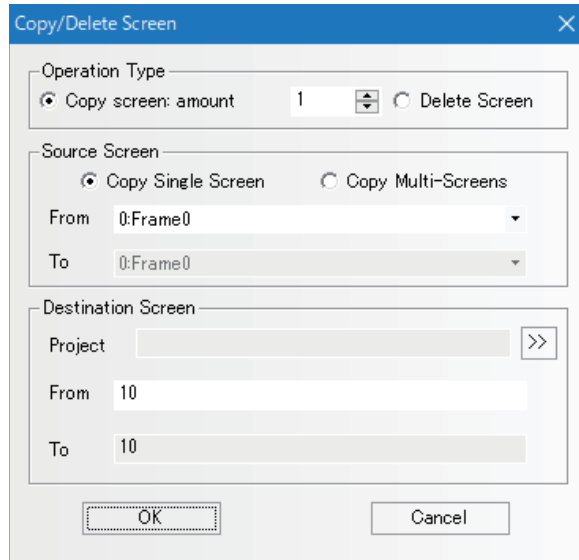

- Copy Multi-Screens

When the number is 1, both the starting source screen ID, the end source screen ID and the starting destination screen ID can be set, and the end destination screen ID will increase automatically according to the number of the source screen, which means the screens and properties of the screens between the starting source screen and the end source screen will be copied in order into the screens between the starting destination screen and the end destination screen respectively.

When the copy number is greater than 1, the starting source screen ID, the end source screen ID and the starting destination screen ID can be set, and the end destination screen ID will increase automatically according to the copied number and the number of the source screen, which means the screens and properties of the screens between the starting source screen and the end source screen will be copied in order and as specified number into the screens between the starting destination screen and the end destination screen respectively.

- Copy and Paste to Other Project

Screens of a project can be copied and pasted to other project by specifying the project in [Project]. Copied screens are pasted to the destination project given the screen numbers which begin with the next number of the last screen number.

**Note** The destination screen ID must be a new screen ID because the existing screen ID doesn't support the screen copy.

(2) Delete Screen

Supports single-screen deletion or multiple-screen deletion.

- Delete Single Screen

The starting screen ID can be set, which means to delete the screen with this ID.

- Delete Multi-Screens

Both the starting screen ID and the end screen ID can be set, which means to delete the screens with the ID between the starting ID and the end ID.



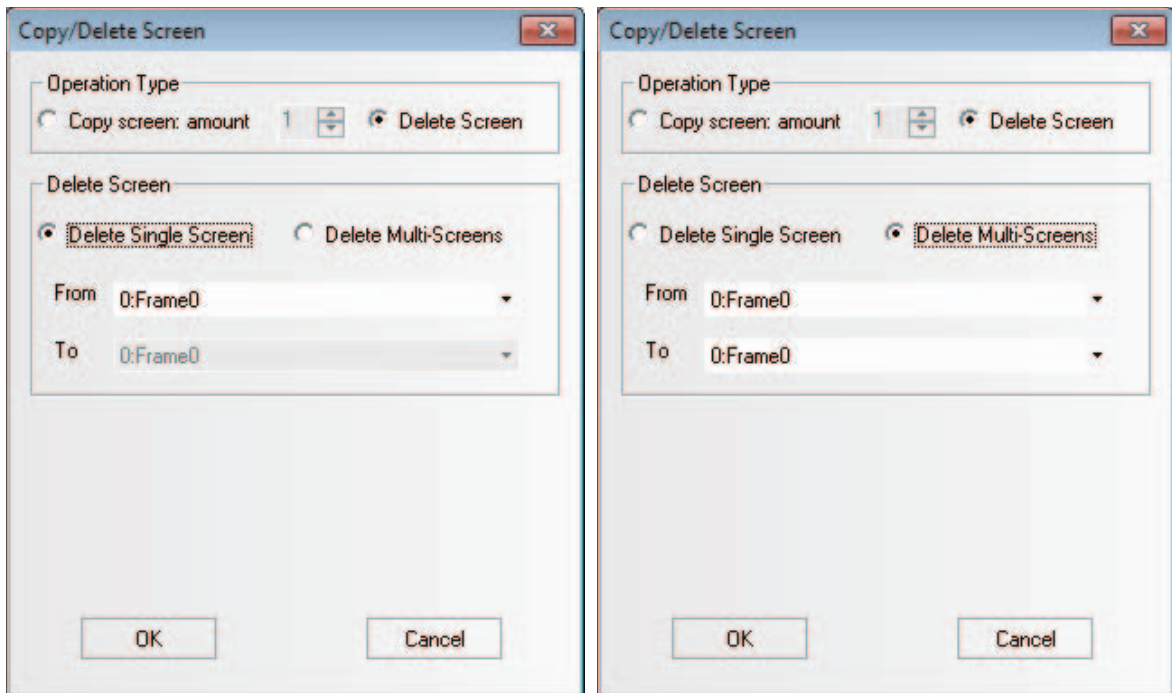

The following example is only for the multiple-screen copying.

We want to copy Frame 6, Frame 7 and Frame 8 into Frame 11, Frame 12, and Frame 13.

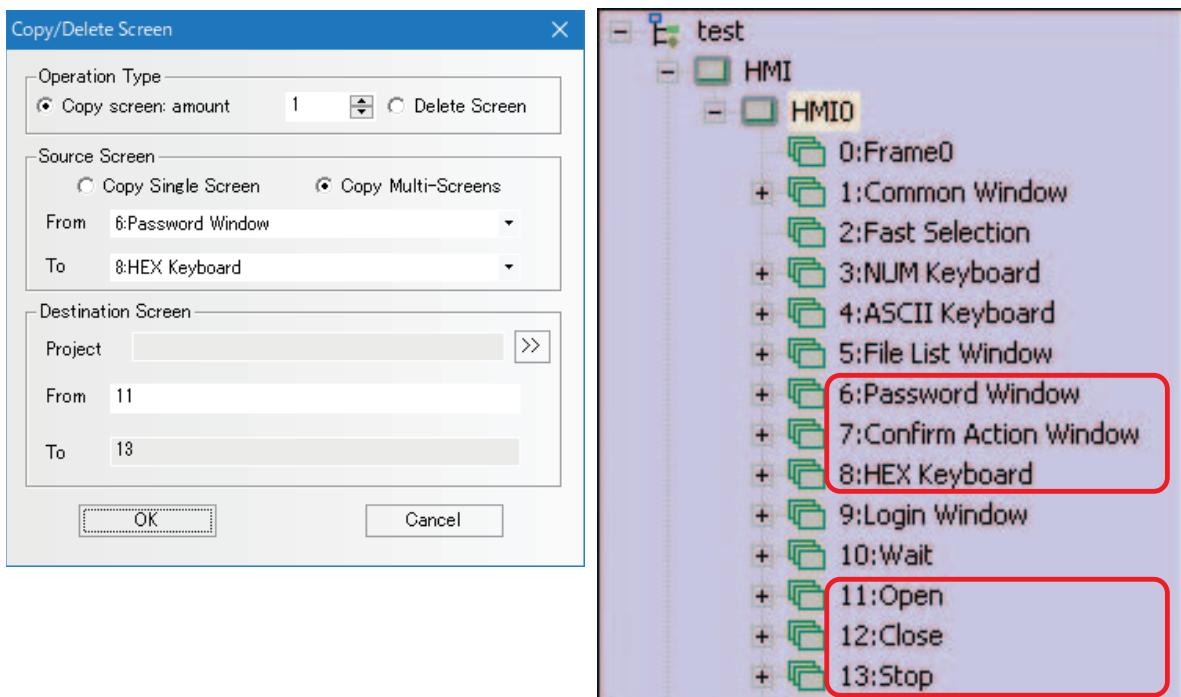

**Note 1** The copy of screens is available within the same project or the same PT.

**2** When the multiple screens are operated, the copying and deletion among the non-continuous screens are not supported.

● **Save Screen Image**

Select a project data and open a screen to enable this function.

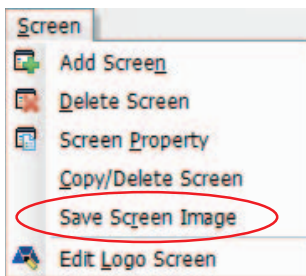

Click [Screen] - [Save Screen Image] , then the dialog box below appears to save the screen images.

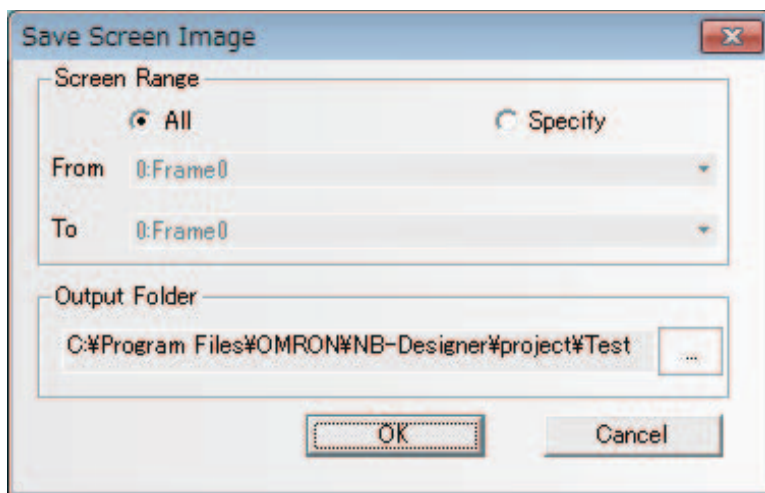

● **Screen Range**

Specify the screen area to save to a file. Select [All] to save all screens. Click [Specify], then the field [From] and [To] are enabled. Specify the range to save.

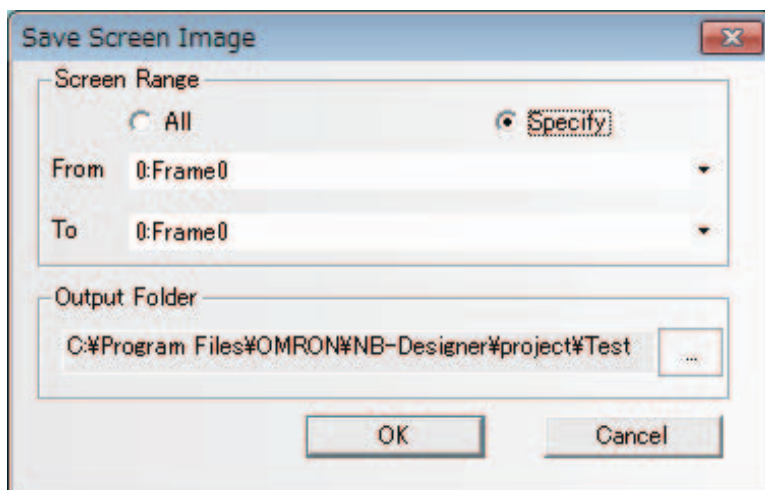

● **Output Folder**

Designate a folder to save the file. The folder where the project data is stored is specified by default.

A screen image data is saved as bitmap file to the designated folder.

### 3-2-5 Draw Menu

The corresponding contents in the [Draw] menu shown as below have been described in 3-2-3 View Menu (Page 3-16) in NB-Designer Operation.

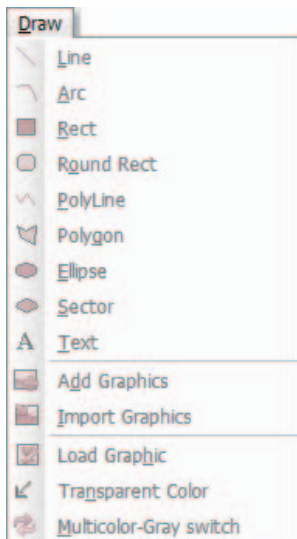

### 3-2-6 Components Menu

For the corresponding contents in the [Components] menu shown as below, refer to 3-6 Parts (Page 3-82), 3-7 Function Parts (Page 3-200) and 3-8 Project Database (Page 3-238) in NB-Designer Operation.

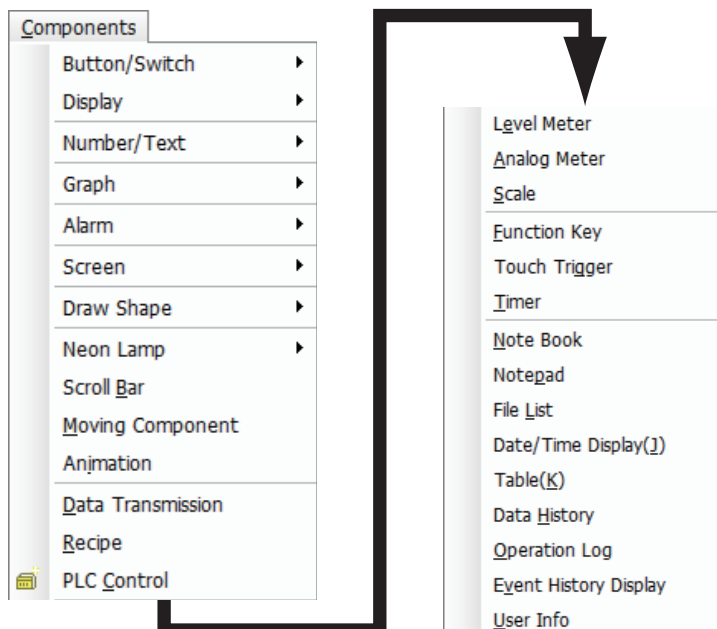

### 3-2-7 Tools Menu

For the corresponding contents in the [Tools] menu shown as below, refer to 3-12 Recipe Data (Page 3-342), 3-14 Test (Page 3-359) and 3-15 Download (Page 3-362) in NB-Designer Operation.

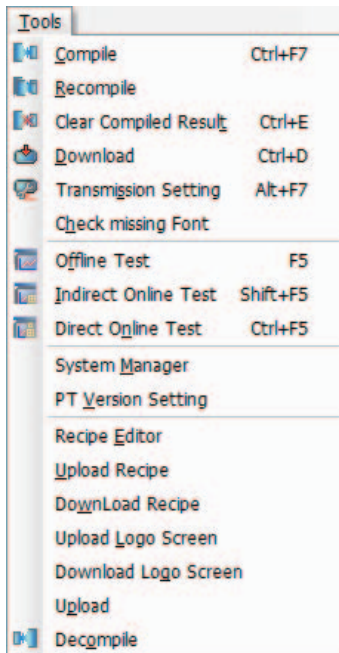

### 3-2-8 Option Menu

The corresponding contents in [Option] menu shown as below have been described in 3-2-3 View Menu (Page 3-16) in NB-Designer Operation.

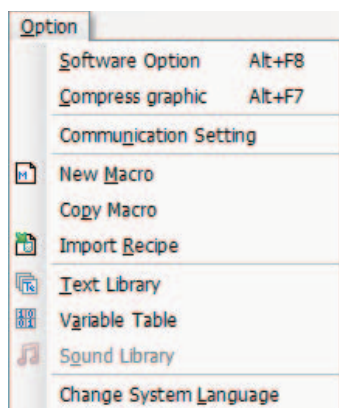

Software option: Sets operation of NB-Designer.

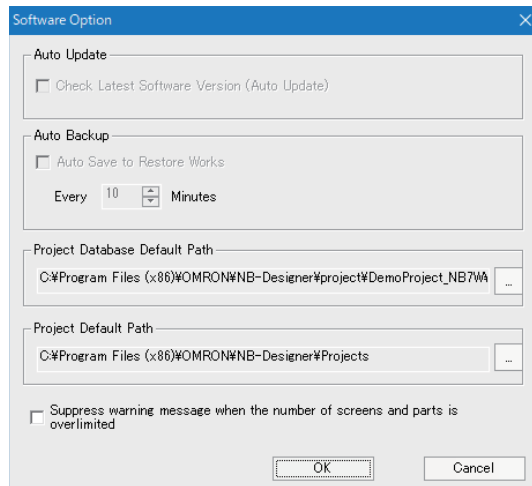

Copy Macro: Macros can be copied and pasted to other project. Copied macros are pasted to the destination project given the macro numbers which begin with the next number of the last macro number.

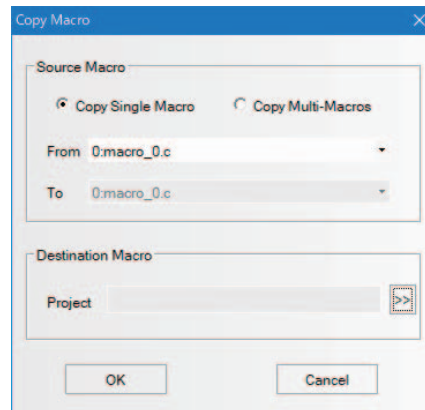

Change System Language: used for changing the system language of the software tool.

## 3-2-9 Window Menu

The corresponding contents in the [Window] menu are as follows.

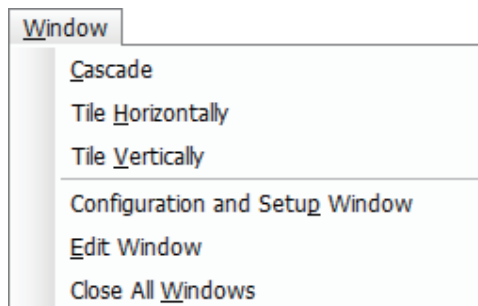

The horizontally-tile window is shown as below.

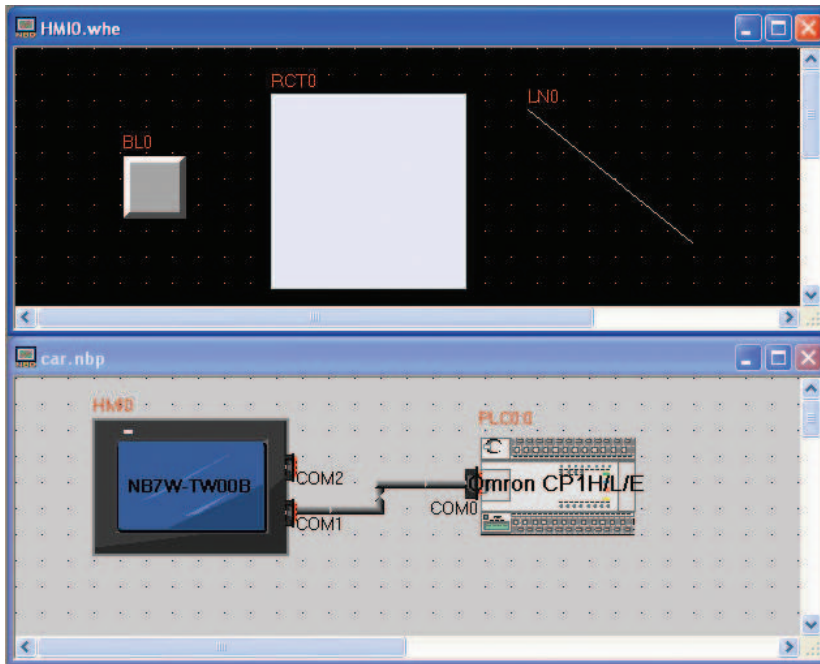

The vertically-tile window is shown as below.

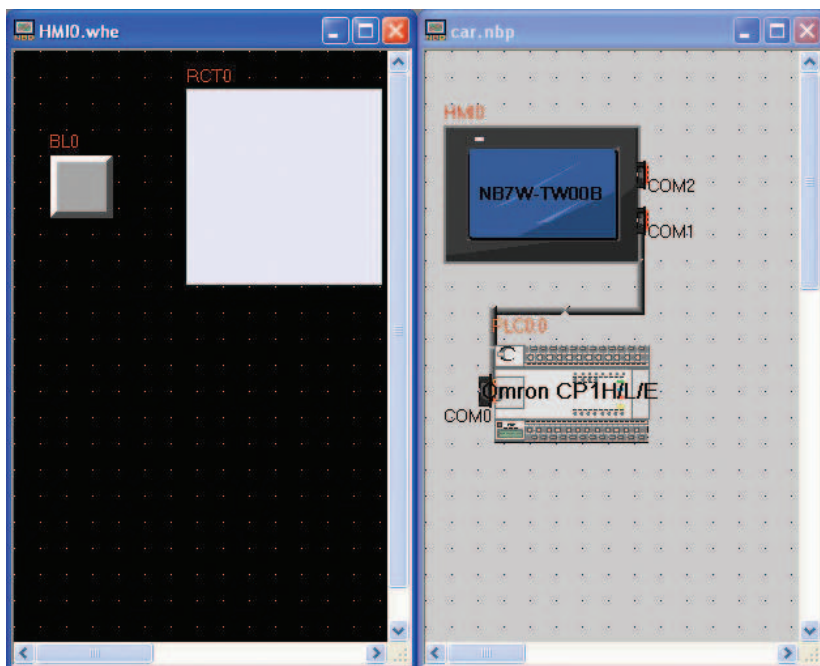

## 3-2-10 Help Menu

The corresponding items in the [Help] menu are shown as follows.

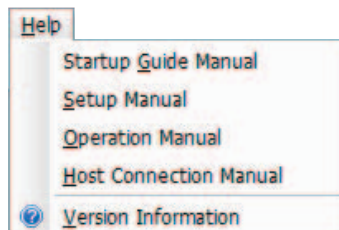

## 3-3 NB-Designer Software Window

NB-Designer has quite a few windows, which will be illustrated in this part.

### 3-3-1 Project Library Window

When starting the NB-Designer, you will see Project Library Window, Project File Window, and Project Work Space shown as below. For the concept of the “screen”, the brief will be provided in *3-4 Screen Concept (Page 3-47) in NB-Designer Operation*.

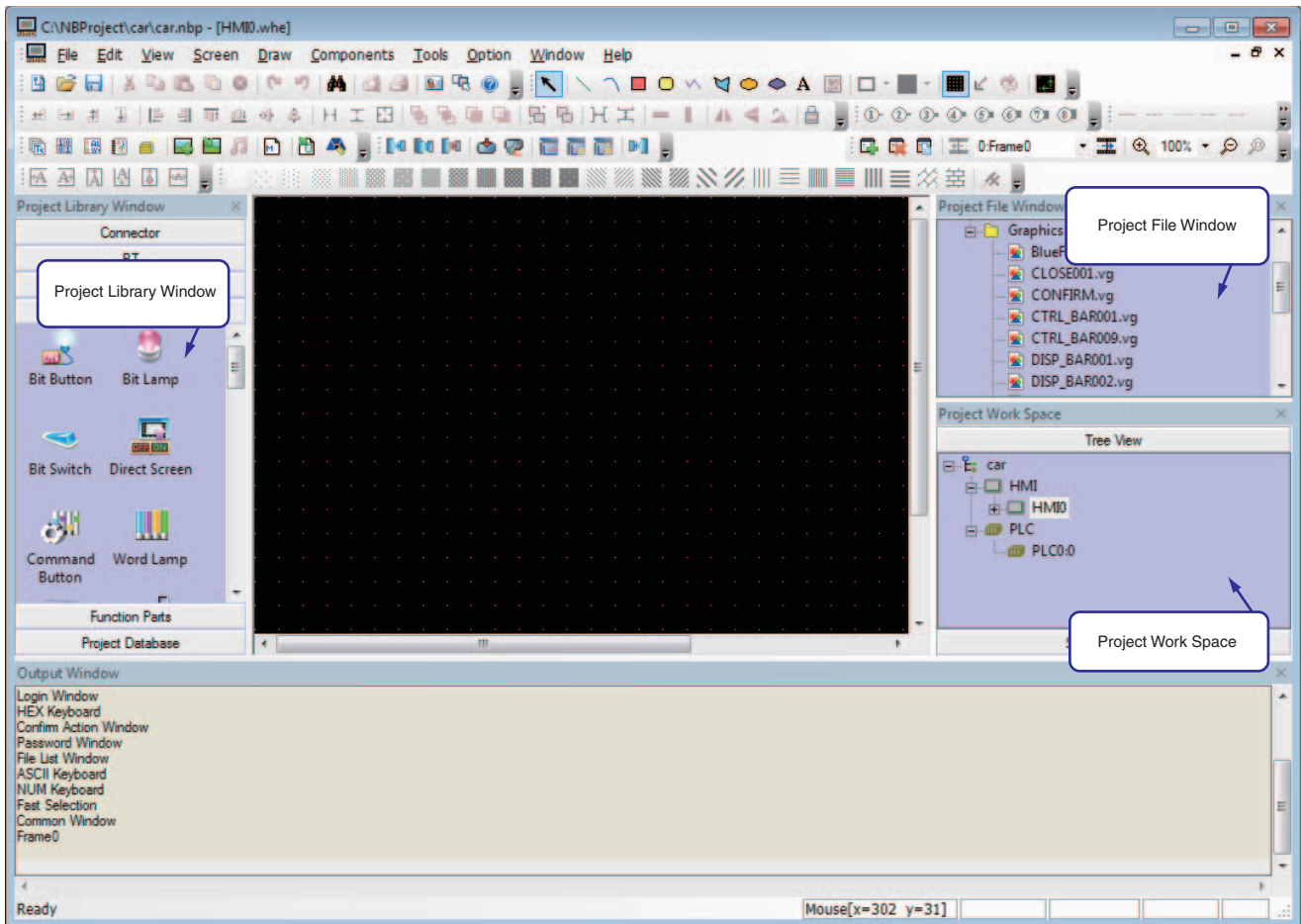

The Project Library Window contains: Connector, PT, PLC, Parts, Function Parts and Project Database.

**Connector:** Serial Port, Ethernet

**PT:** NB7W-TW10B, NB7W-TW11B, NB5Q-TW00B, NB5Q-TW01B...

**PLC:** OMRON, SIEMENS, MITSUBISHI, Schneider...

**Parts:** Bit Button, Bit Switch, Word Lamp, Data Log, XY Graph, Number Input, Text Input...

**Function Parts:** Scale, Function Key, Alarm Display, Timer...

**Project Database:** Text Library, Variable Table, PLC Control...

**Directions:****1 Connector**

Just click “Serial Port”, and drag it to the Project Work Space.

**2 PT**

Check your PT type, find and drag the PT with the same type in the “PT” to the Project Work Space.

NB7W-TW1□B only appears when Simplified Chinese, Traditional Chinese, or English is selected in the [Option]-[Change System Language] menu of NB-Designer.

**3 PLC**

Check your PLC type, find and drag the PLC with the same type in the “PLC” to the Project Work Space.

After finishing selection of the PLC, PT and Connector, carry out connection. The connection method is as follows: move the locations of PT and PLC accordingly, or click one end of the connection line and drag it to the vicinity of the COM port of the PLC or the PT, then bring the connection port close to either end of the connection line, and a successful connection can be completed.

**Note** If the PLC or PT is not dragged into the “Project Work Space”, both of the “Project File Window” and “Project Work Space” will be empty, as shown below.

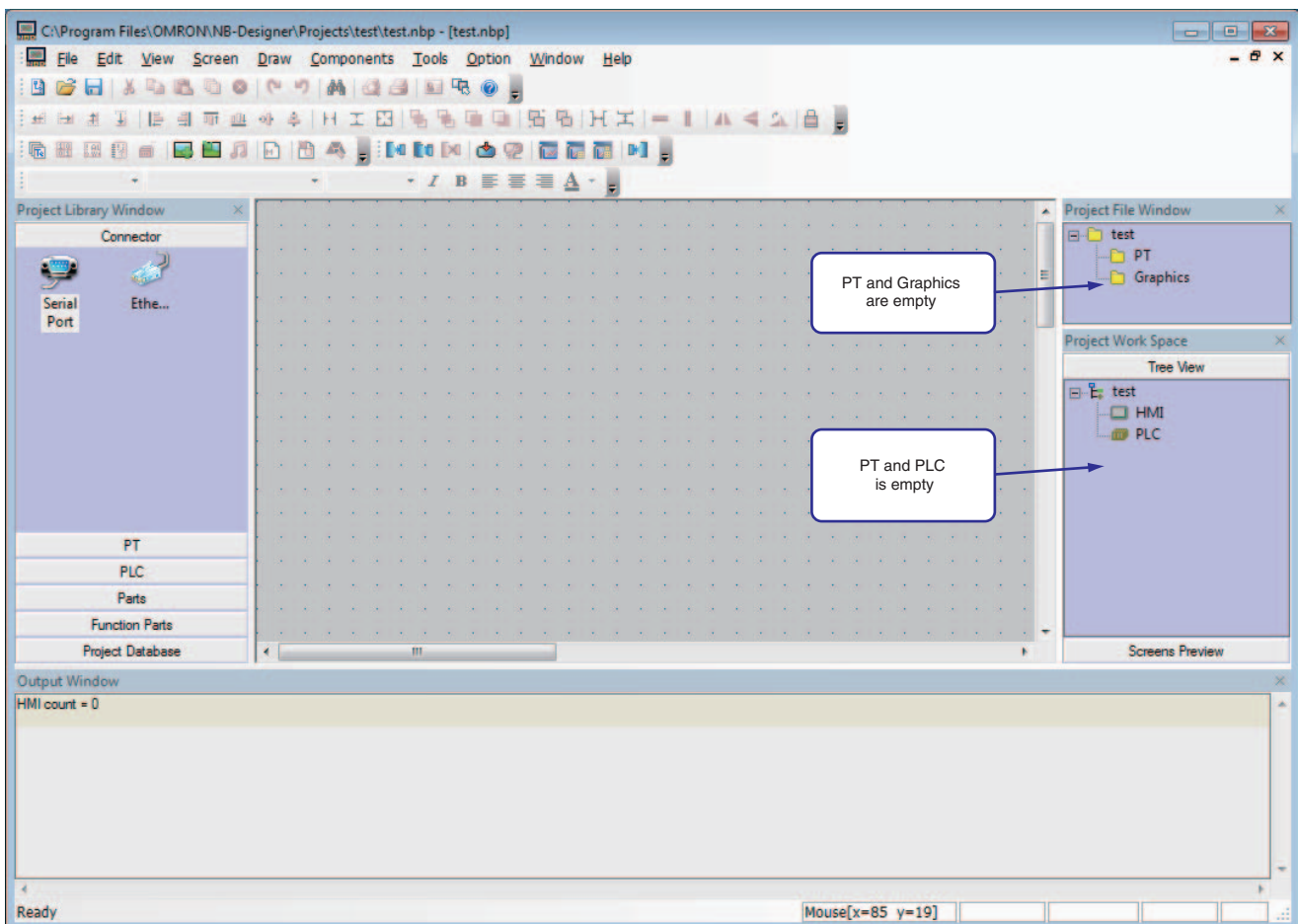



Once the PLC and PT are dragged in, the “Project File Window” and “Project Work Space” will be filled with appropriate content, as shown below:

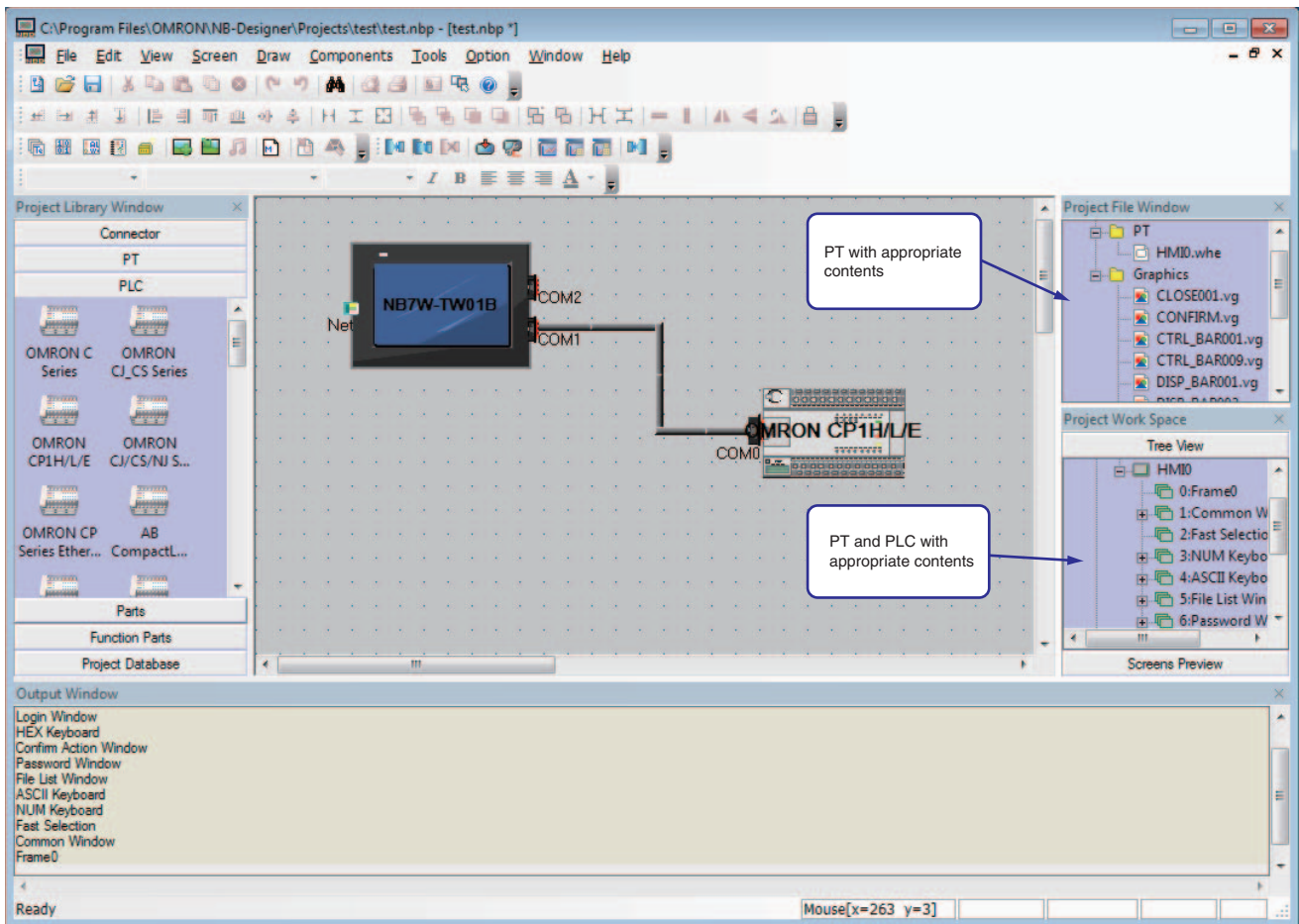

## 4 Parts

These include various editing components, as shown below:

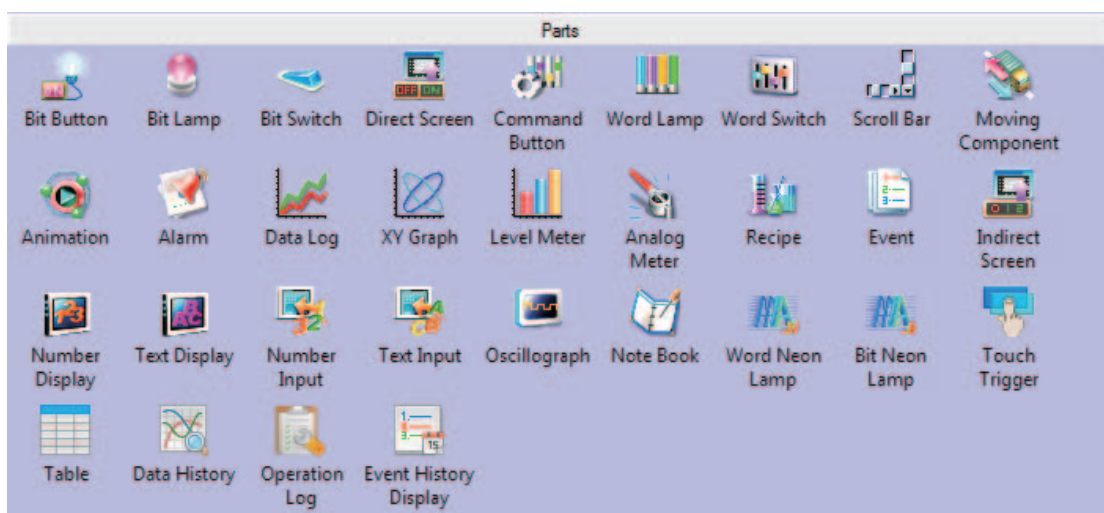

When a project is created, and the Edit Window is entered, it just needs to drag the required components to the Edit Window.

As to the usage methods of the components, refer to 3-6 Parts (Page 3-82) in *NB-Designer Operation*.

In the Project Library Window, you can right-click, select and use “Small Icon”, as shown below.

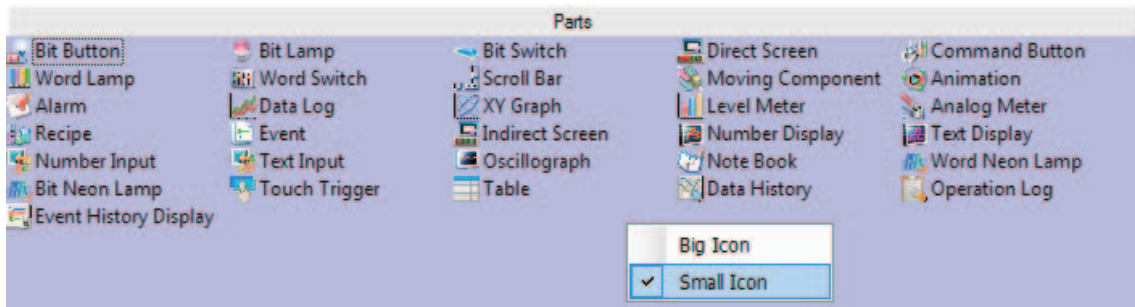

## 5 Function Parts

These include Scale, Function Key, Alarm Display, Timer, etc. For details, refer to *3-7 Function Parts (Page 3-200)* in *NB-Designer Operation*.

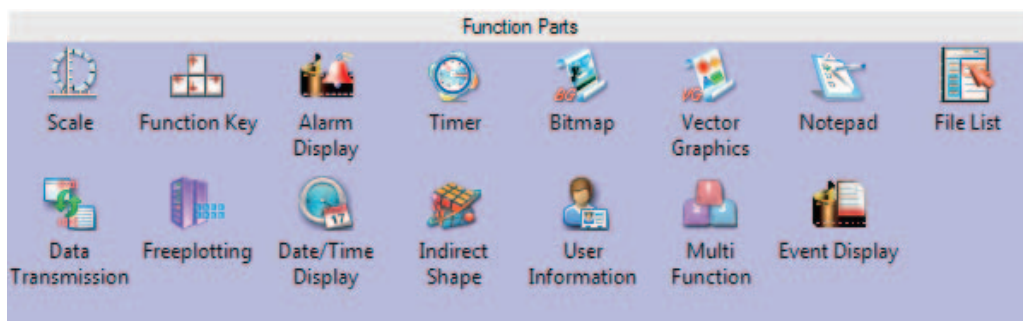

## 6 Project Database

This contains Text Library, Variable Table, Alarm Information, Event Information and PLC Control. For details, refer to *3-8 Project Database (Page 3-238)* in *NB-Designer Operation*.

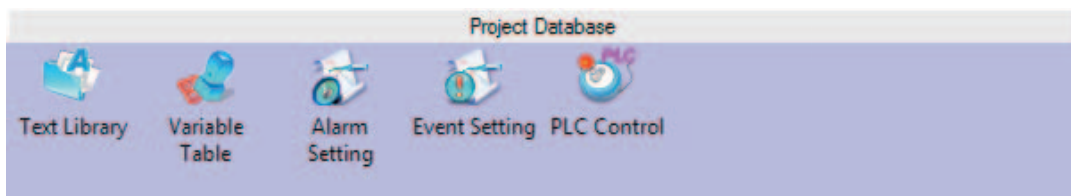

### 3-3-2 Project File Window

The Project File Window is intended for displaying information about the PT, Macro, Recipe and Vector Graphic, etc. contained in a project. If this project uses 1 PT, only one “HMI0.whe” will appear below the [PT]. if 3 PTs are involved, “HMI0.whe, HMI1.whe, HMI2.whe” will appear accordingly. The rest can be deduced from this. See the following diagram.

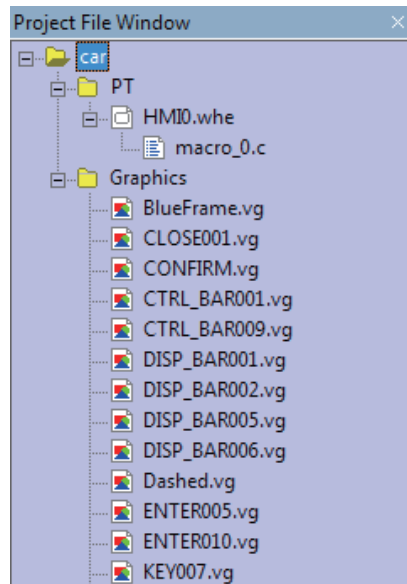

By clicking the “+” or “-” symbol on the left of the icon, the folder tree can be unfolded or folded.

By double-clicking a specific file, the editing state can be entered.

**Note** The recipe file (.RCP) can only be imported and deleted, but not be edited in the Edit Window.

#### Graphics

The Graphics mainly indicates this project contains how many Vector Graphics and bitmaps. If a new Vector Graphics or bitmap is created in this project, it will show up immediately here. If a created Vector Graphics or bitmap is double-clicked, the screen will be switched to the graphics edit window immediately. For Vector Graphics and bitmaps, refer to 3-5-5 *Vector Graphic* (Page 3-60) and 3-5-6 *Bitmap* (Page 3-65) in *NB-Designer Operation*.

### 3-3-3 Project Work Space

The Project Work Space is mainly intended for displaying the structure of the project, and contains two parts: PT and PLC, as shown below.

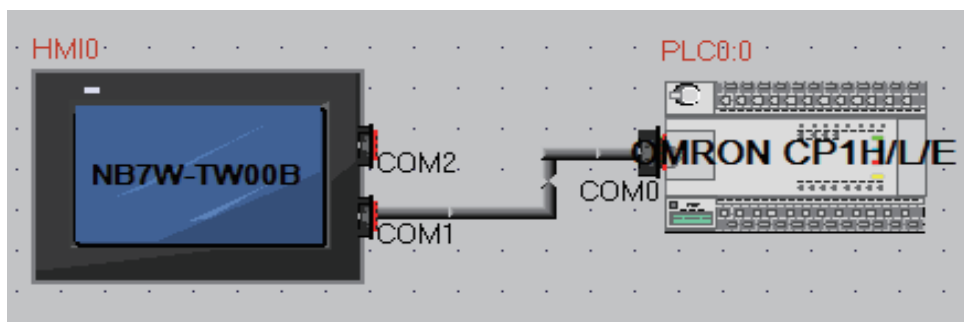

And the schematic diagram is shown as below.

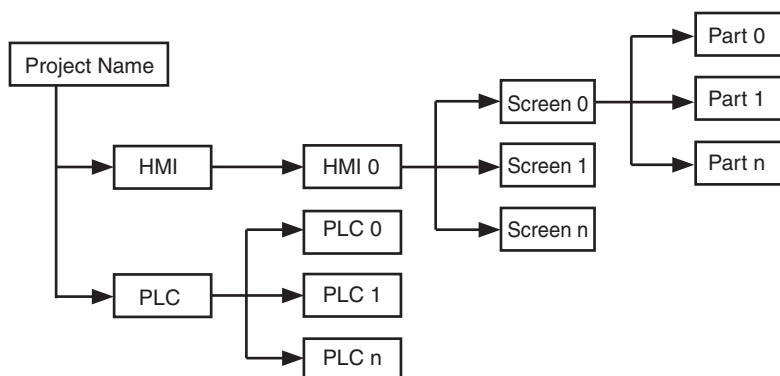

● **PT**

It mainly displays (stores) the PT used in the project, which also has a subfolder. Every folder stores its own structure. NB7W-TW10B and NB7W-TW11B can only be selected when the System Language of NB-Designer is English, Simplified Chinese, or Traditional Chinese. Data that includes these models can only be opened when one of the above languages is selected.

● **PLC**

It mainly displays (stores) the number of PLC, PLC No. and Station No. addresses used in the project.

**Note** Creating a new project for each PT is recommended.

● **Tree View**

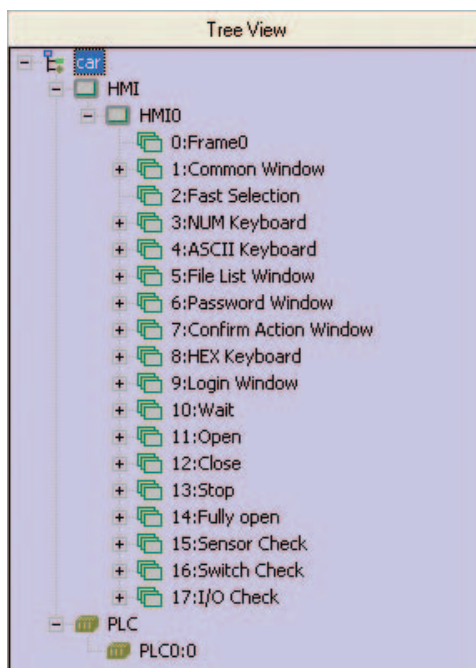

All the components contained in each screen will be displayed here, and if there is no component in a screen, nothing will appear below it.

By clicking the “+” or “-” symbol on the left of icon, the folder tree can be unfolded or folded. Directly double-click the Screen or the component No. in the Screen to skip to the edit page involving the component. When a Screen or component is selected, pressing the DELETE button can delete the related screen or component.

Explanation about the characters on the top of the PLC Property window.

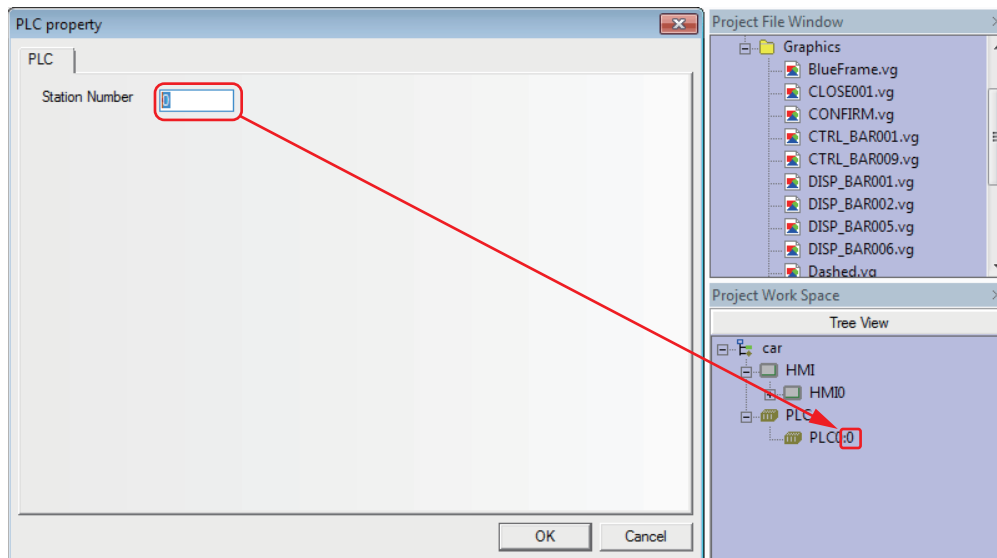

The first digit indicates the PLC No. currently used.

The second digit indicates the Station No. of PLC currently used.

### ● Screens Preview

Click [Screens Preview] in the [Project Work Space] to display the preview of the corresponding screen. This makes browsing the thumbnails quite conveniently.

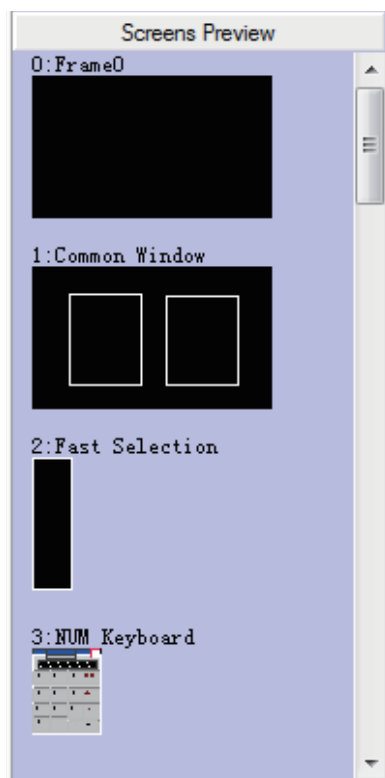

### ● PLC and PT replacement

#### • Supporting PLC Model Replacement

**Note** PLC replacement must be carried out through the [Change PLC Model] option. If you do not use this function and delete all the settings of PLC to reconnect with the new PLC, the PLC area is replaced with all the local addresses of PT.

It provides a parameter setting dialog box for the PLC to be replaced and other PLCs in the navigation mode for the user to make replacement operation. Select a PLC and right-click it in the Configuration and Setup Window to make the pull-down menu popup, and then click “Change PLC Model”.

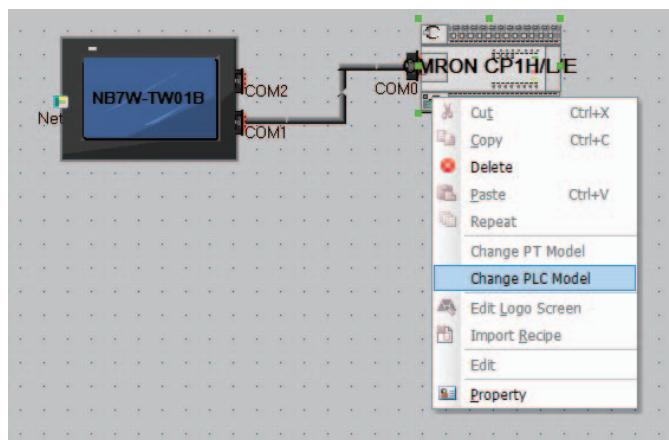

Then, the Change PLC Model dialog box will pop up, as shown below.

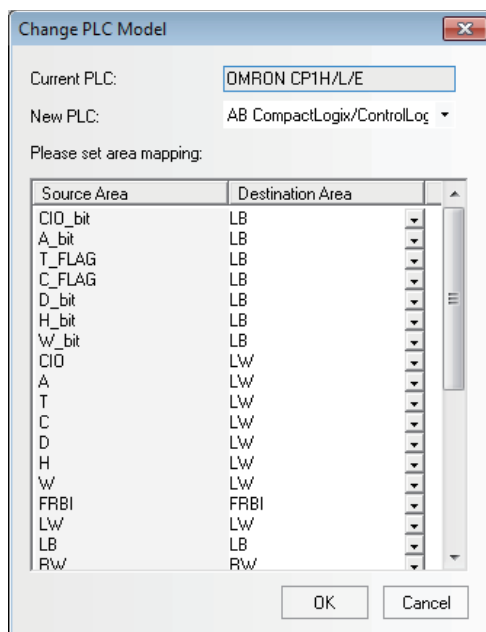

A dialog box as shown above will pop up automatically, and all the supported PLC names are included in the pull-down list of the PLC names. When the user select a PLC, the memory address types supported by this PLC will be added to the address type box. The default selections are LB & LW, but the user can select different address types according to the specific PLC. After being confirmed by the user, the PLC will be replaced, and the corresponding PLC memory address in the project will also be replaced at the same time.

**Note** The function does not support the replacement from the unit type of the Ethernet connections to the unit type of the serial connections.

An example of setting addresses for [Current PLC] and [New PLC] are as follows.

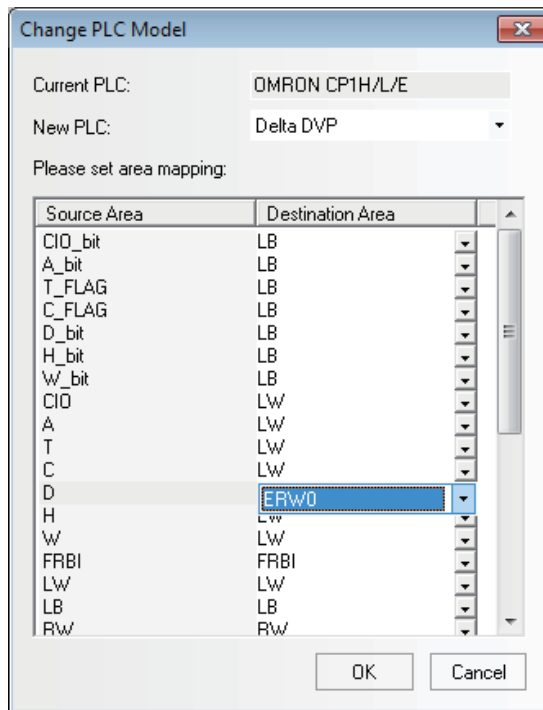

#### • Supporting PT Model Replacement

**Note** PT replacement must be carried out through the [Change PT Model] option. If you do not use this function and delete all the settings of PLC to reconnect with the new PLC, the PLC area is replaced with all the local addresses of PT.

**Note** If the previous data uses an interface device that the model that you want to change to does not have, the model cannot be changed.

When the PT needs to be replaced, you can select the PT by right-clicking it in the Configuration and Setup Window, and select "Change PT Model" in the pop-up menu.

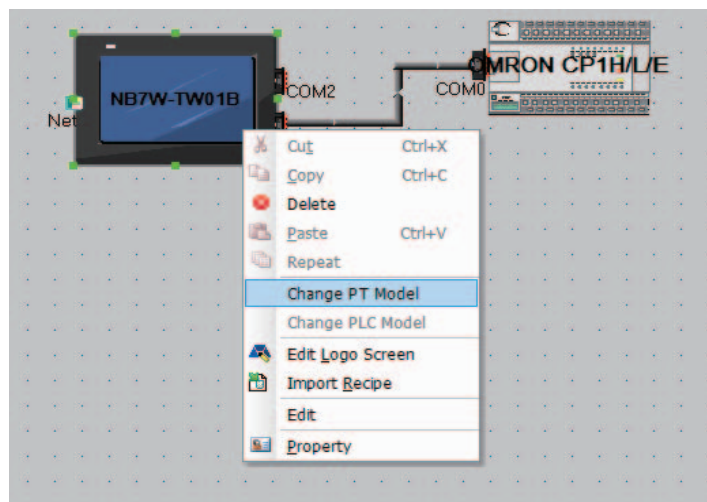

The following dialog box will pop up automatically.

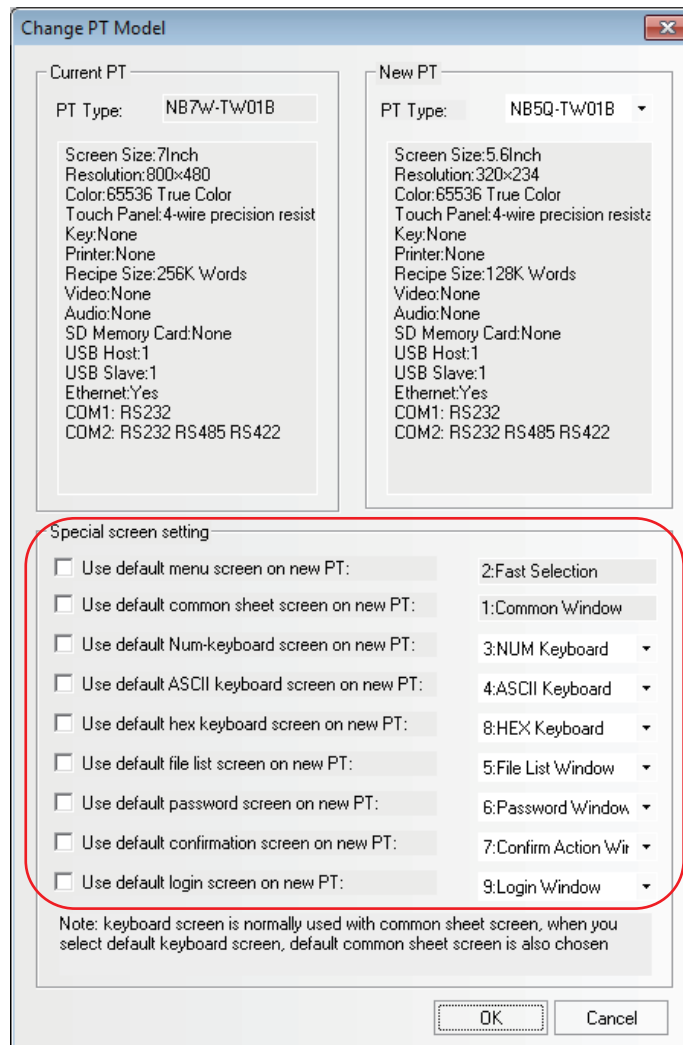

Here, the name and descriptions of the Current PT cannot be altered, while the pull-down box of the New PT lists all the supported [PT type], and the descriptions displayed at the lower part will be updated automatically according to the type selected by the user. After being confirmed, the PT will be replaced, and all the size of graphics in the PT will zoom automatically according to the resolution of the screen.

After the PT is replaced, the original user edit screen will be adjusted by related scales according to the difference of the resolution of various types. All the components with screen display will adjust automatically. For example, all the components (such as the bitmaps, Vector Graphics, button and lamp, etc.) with location and size adjustments can all change their sizes automatically. However, note that there are a few exceptions: as the font size of text strings and label can't be changed, the components using text strings and label will be restricted to mainly display the text in the minimum display area when size changes, especially when it becomes smaller as square components like the Analog Meter change sizes in a "square" way, the changed sizes may disrupt the proportion among the component sizes, therefore it requires a second fine-adjustment by the user.

By the [Special screen settings] in the dialog box, the special screen which will be replaced to Replace PT is set. If the [Special screen settings] is not used, the special screen of the Current PT will continue to be used.

If the resolutions of the Current PT and New PT are the same, no adjustment is required. But on the contrary, if they are different, it will require the user to adjust the fonts and pictures to appropriate sizes.



### 3-3-4 Output Window

The Output Window mainly displays compilation information of the project so that the user can precisely pinpoint where errors lie, as shown below.

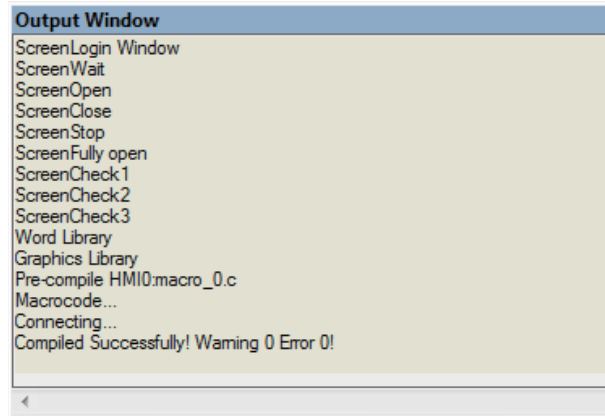

When the project is opened, the Output Window will display the loaded information of the project. when the project is compiled, the Output Window will display the compilation process and error information.

- **Clearance/Export of Message**

The compiled information can be cleared or exported in the Output Window. Right-click the mouse in the [Output Window], the following menu will pop up.

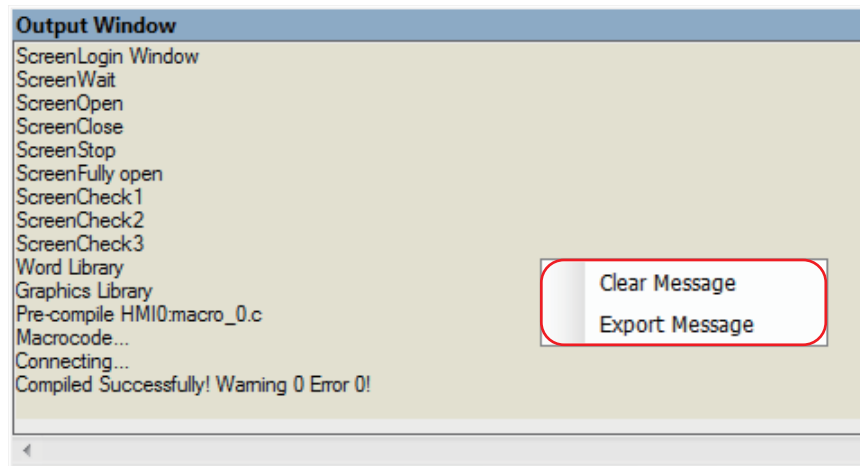

**Clear Message:** All the information in the Output Window will be removed.

**Export Message:** All the contents in the Output Window are exported to the folder which contains the current project, forming a file named "log.txt".

### 3-3-5 Component List Window

If the [Component List Window] is selected from the [View] menu, the Component list window will pop up.

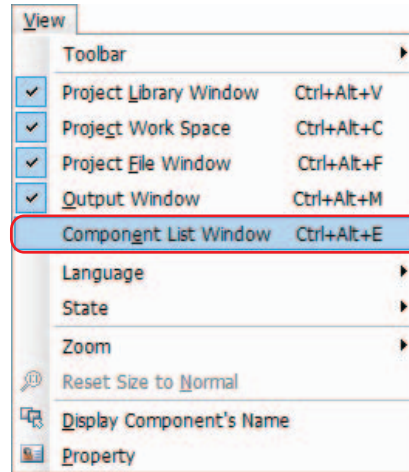

PT	Screen nu...	Screen	Component	Host (Read)	Read Address (Wo...	Host (Write)	Write Address (Wo...	Functional address...	Funcio
HMI0	1	Common ...	DW2		LB:9061(1)				
HMI0	1	Common ...	DW1		LB:9064(1)				
HMI0	3	NUM Keyb...	TD5		LW:9190(6)				
HMI0	3	NUM Keyb...	TD4		LW:9180(6)				
HMI0	3	NUM Keyb...	TD3		LW:9070(6)				
HMI0	4	ASCII Keyb...	SB9				LB:9100(1)		
HMI0	4	ASCII Keyb...	TD9		LW:9060(16)				
HMI0	4	ASCII Keyb...	TD8		LW:9152(16)				
HMI0	4	ASCII Keyb...	TD7		LW:9140(16)				

This window displays all the component information used by the project, including PT No., Screen, Component's Name, Read PLC, Read Address, Write Address, Functional Address etc. Double-click an item to reveal the Properties of the selected component, and the Edit Window will skip to the screen where this component locates.

## 3-4 Screen Concept

### 3-4-1 Screen Types

The project of the NB-Designer is composed of multiple screens. There are 3 types of screen, i.e. Base Screen, Common Sheet and Menu Screen. The Base Screen after its size is changed can also be used as Pop-up Screen. All the screen can be used as the Sheet Screen.

#### ● Base Screen

This is the common-type screen. When Base Screen is switched by using “Screen switching” command, the current screen will be cleared (All the screen rather than Common Sheet and Menu Screen will be cleared.), and Base Screen to be switched to will be displayed in the current screen. When the component in Base Screen calls the pop-up screens out, the original information in Base Screen will be reserved, and the called pop-up screen will be attached to the current Base Screen. The master-slave relationship is between Base Screen and all of related pop-up screens. When Base Screen N is switched to Base Screen M, all of the sub-screens of Base Screen N will be closed while Base Screen M and its sub-screens will be displayed. Base Screen must cover the whole screen.

#### ● Menu Screen

Menu Screen is the screen called by pressing the button of Menu Screen while the task-bar is displayed, and it will be always displayed in the screen until the operation button makes it hidden. Therefore, it can be used to put screen-switching button or some other common components. The default Menu Screen is Frame 2. When the other screen is set as Menu Screen, the size of that screen must be same as that of Menu Screen.

#### ● Common Sheet

Common Sheet will always be displayed in the screen, and the components to be displayed forever can be put in Common Sheet. In this way, you can see the state of this component or operate this component at any time. The default Common Sheet is Frame 1. You can use [Change Common Sheet] function key to switch the other screen as the current Common Sheet, but only one screen can be used as the current Common Sheet.

#### ● Sheet Screen

3 Sheet Screens (max.) can be set for the screen in [Screen Property] dialog box. Sheet Screen is generally used to put some common components such as background graphics, charts and titles and so on for the multiple components. Each screen can be set as Sheet Screen.

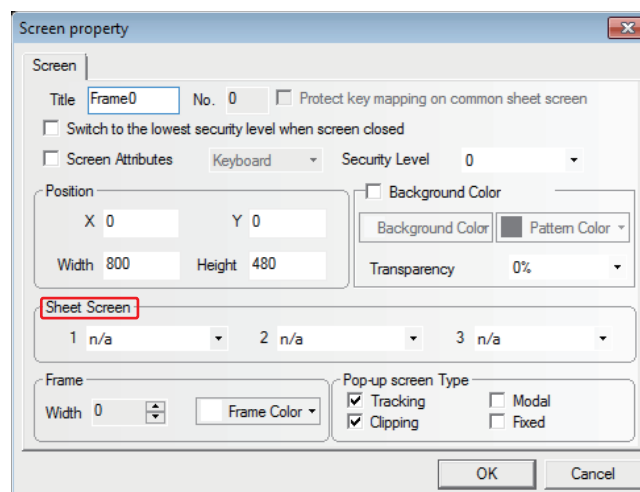

As shown above, Sheet Screen can be selected directly from the [Sheet Screen] option. Sheet Screen is different from the general screen. The components in Sheet Screen will be inserted into the general screen during the running, and in fact Sheet Screen isn't displayed at all, but the display and control of its components are similar to that of the components in the general screen.

### ● The Relationship of Screen

One screen can include Common Sheet, Base Screen and Menu Screen while one Common Sheet or Base Screen can include many pop-up screens. And the relationship between them is shown as below.

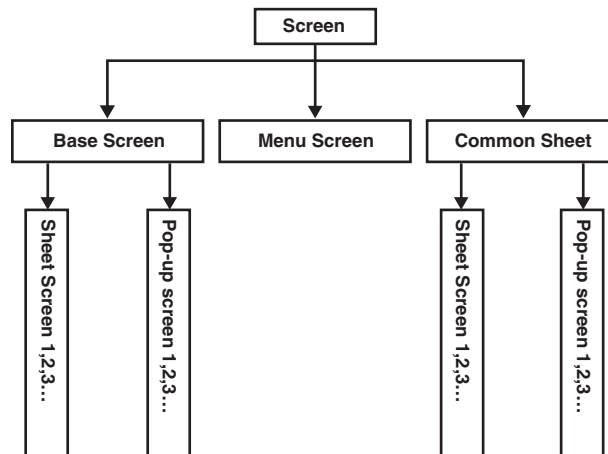

When the screen-switching command is executed, the PT will clear the current screen (the pop-up screen attached on the current screen etc included) and switch to the screen to be displayed, but Common Sheet will always be displayed in the screen. The original contents of Base Screen can't be changed by the pop-up screen that called by the direct screen or indirect screen, and the pop-up screen is just attached to Base Screen. In addition, up to 3 sheet screens can be set for each screen in screen property setup.

When one Base Screen (Screen No. is 0 or ranges from 10 to 32767) is called out, all the components in this screen will be displayed in the PT. If Base Screen has the Sheet Screen, all the components defined in its Sheet Screen will be displayed. All of the Touch Trigger components (such as Bit Button, Function Key etc.) defined in the Sheet Screen are valid in the current screen. If there are display components in Common Sheet, they will be displayed in the current screen. And all the Touch Trigger components defined in Common Sheet are valid.

Each project includes 32768 screens (max.) (Base Screen, Common Sheet and Menu Screen etc included), and only one screen can be used as Menu Screen. But you can use [Change Menu Screen] function key to make the screen switch to the specified screen as Menu Screen. For details, refer to 3-7-2 Function Key (Page 3-201) in *NB-Designer Operation*.

Each new project has a default initial screen, and the default screen No. is 0 (If you want to change it, you just need to make changes in [PT Property] in project editing screen.). The valid screen No. ranges from 0 to 32767.

The default Common Sheet and Menu Screen for the project are Frame 1 and Frame 2. If you want to change the default Menu Screen and Common Sheet, you just need to double click PT to modify [PT Extended Property], as shown below:

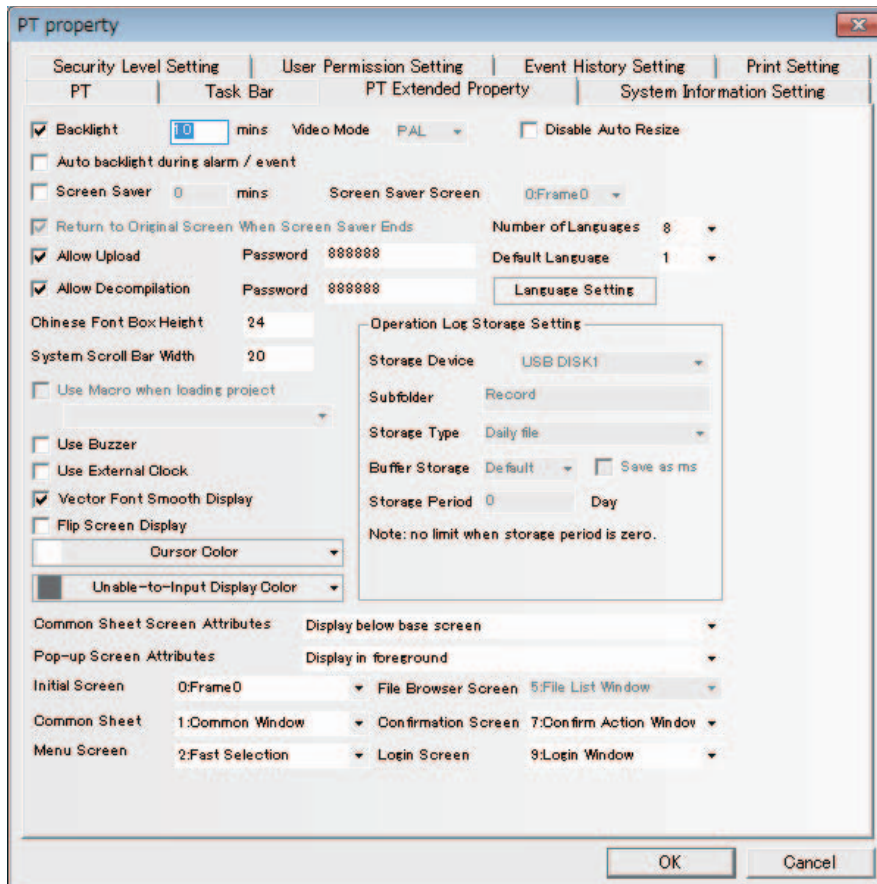

**Note 1** 16 pop-up screens can be opened simultaneously.

- 2 More than two of the same screens cannot be called from one screen simultaneously. Therefore you can't open the same screen by using 2 direct (indirect) screens in the Base Screen.
- 3 The screens closed by the function keys can't close the Direct Screen or Indirect Screen, because the opening or closing of Direct Screen is related to the ON/OFF status of bit address that controls the Direct Screen, while the opening and closing of Indirect Screen is just related to the data content of the word address that controls the Indirect screen. The screen closed by the function keys can't change the values of these bits (words) addresses, so it can't close these screens mentioned above.
- 4 All the Pop-up Screens are attached to the current Base Screen, so when the current screen is closed (or switched to the other Base Screen), the attached Pop-up Screen will be closed. In this case, if the screen is switched back to this Base Screen, you will find that the Pop-up Screens originally attached to this Base Screen still exist (Otherwise there are commands sent to close them.)
- 5 Base Screen must cover the whole screen.
- 6 Every Pop-up Screen belongs to the screen where the component ejecting them locates, and master-slave relationship is between them. Therefore, the screen opened by the component in Common Sheet will always be displayed until Common Sheet closes it again.

### 3-4-2 Screen Property

The methods to change the screen property:

- Double-click the area in which no components are arranged in the screen.
- Do not click the components in the screen and click the  icons of tool bar.

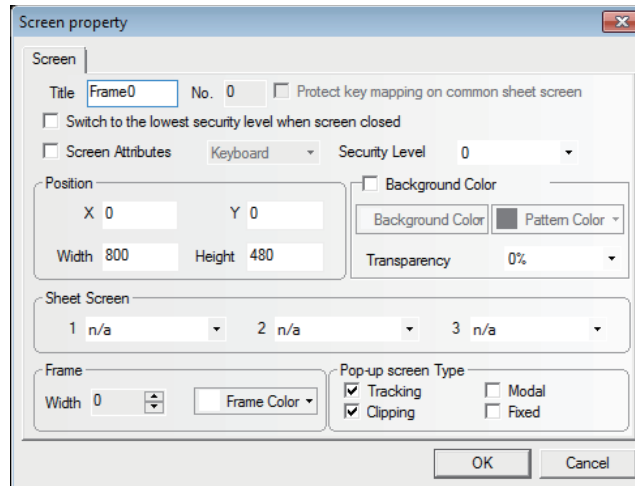

- **Title**

Assign the unique name for each screen for convenient differentiation. Of course, the screen title can be changed.

- **Screen No.**

Screen No. range is from 0 to 32767. When a new screen is created, automatically is assigned a Screen No.

Screens from 0 to 10 are fixed. The screen No. of the other screens can be changed by the user. Screen No. can be not consecutive.

- **Position**

When the screen is the screen ejected by using “Pop-up Screen” function of the function key, the vertex in the upper-left of the screen will be displayed in this position.

- **Width and Height**

Width and height can be set for the Pop-up Screen, and if it is the Base Screen, it must be set to the default size (i.e. the size of the full screen).

- **Screen Attribute**

Keyboard page determines whether to set the screen as Keyboard Screen. Print page can be used to set the size of this screen regardless of the limitation of the actual resolution of the PT. The NB-S series does not support [Print page].

- **Protect key mapping on common sheet screen**

The NB-S series does not support this function.

- **Switching to the lowest security level when screen closed**

If the security level is set for one screen to realize the function, i.e. the password will be cleared automatically when the screen is closed, and the password needs to be input again when the screen is entered again, the security level will become 0 only if the screen is closed.

### ● Background Color

If the filling effects for the screen are needed, select this option.

### ● Pattern Color and Background Color

The selected [Pattern Color] is applied as outline color and the selected [Background Color] is applied as ground color. For details, refer to the descriptions of “Fill Style Toolbar” in 3-2-3 View Menu (Page 3-16) in *NB-Designer Operation*. In the default settings, the [Pattern style] is set to 0 so that only the background color is displayed by this setting.

### ● Pop-up Screen Type

The types are “Tracking”, “Modal”, “Clipping” and “Fixed”.

The above parameters show the relationship between one Pop-up Screen and its adjacent screen. If one Pop-up Screen features “Modal”, the location of parent screen will be frozen after it pops up, and the pop-up screen will always be displayed in the Top layer. If one Pop-up Screen features “Clipping”, the border of this screen will be restricted by its parent screen, i.e. the part displayed out of the border of its parent screen will be cut off. If one Pop-up Screen features “Tracking”, it will move together when its parent screen moves.

**Note** If “Clipping” is selected, “Tracking” must be selected simultaneously.

The following Screen A and Screen B are both attached to the Base Screen. Generally, Screen A will be displayed in the Top layer when it is touched. But if “Fixed” is selected for Screen A, it will not be displayed in the Top layer even if it is touched, but it will always be attached to its parent screen.

**Note** The screen No. can't be changed once it is created, but the name, frame and background can be changed still.

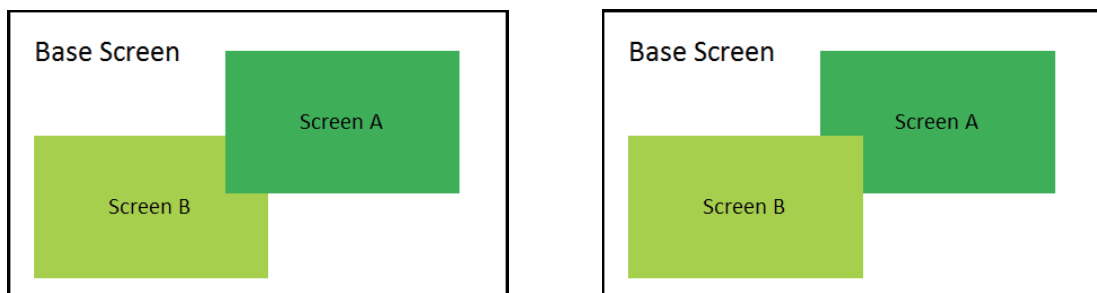

### ● Security Level

Set the corresponding security level for the screen. For details, refer to 3-13 Security Level (Page 3-353) in *NB-Designer Operation*.

### ● Sheet Screen

Set the corresponding Sheet Screens for the current screen. The screen to be set as the Sheet Screen must be the created screen, where the components used by the multiple screens together can be put.

### ● Frame

Refers to the frame recommended to be used by the Pop-up Screen. The width of the frame can be any number from 0 to 16. If the width is not 0, the color can be selected for the frame.

● **Transparency**

It is only valid for the Pop-up Screen and the Menu Screen.

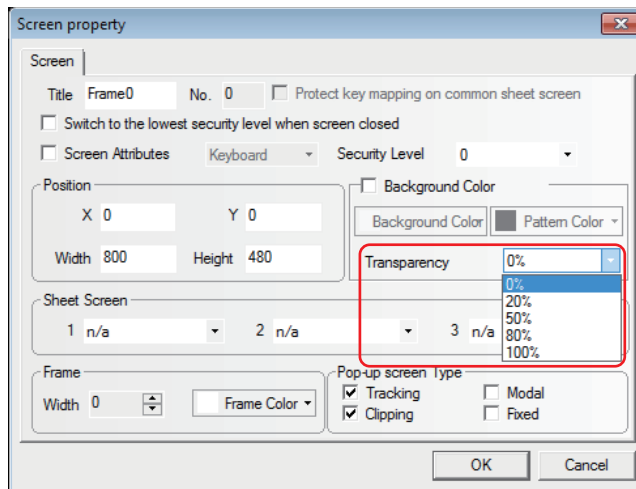

Example of transparency of Pop-up Screen

Placing one function key to [Pop-up screen] “Frame 10” with the property in “Frame 0”, as shown below.

- When the transparency is 0%.

Set the width and height of Frame 10 to “200” each, the [Background color] to “Yellow”, and the [Transparency] to “0%”, as shown below.

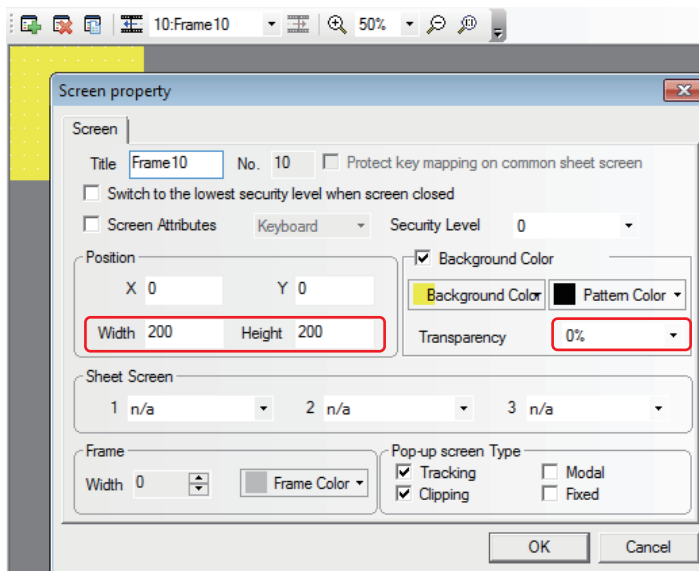

Perform the offline test, as shown below.

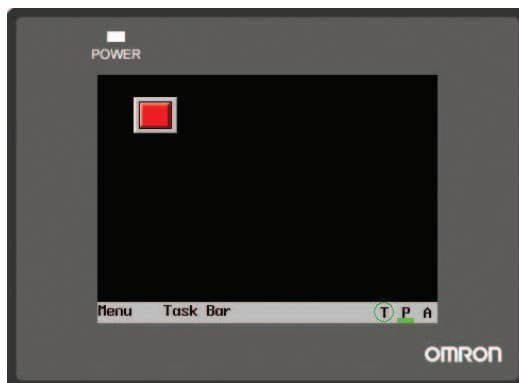



Press the function key and pop-up Frame 10 will cover the function key, which is caused by the transparency of 0% for Frame 10, as shown below.



- When the transparency is 20%.

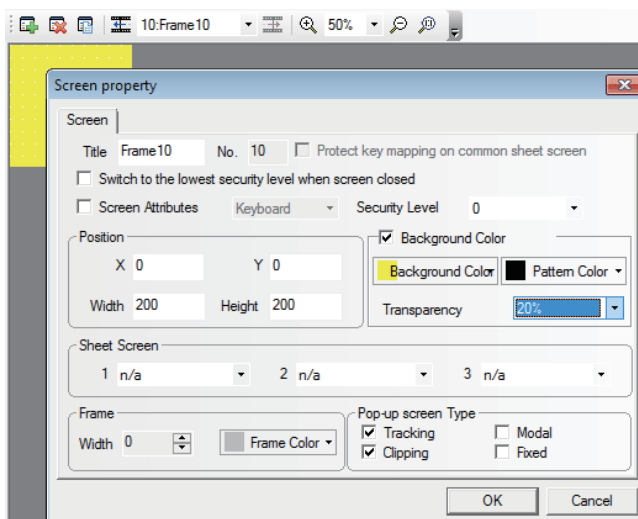

Perform the offline test and press the function key, the displayed effect is shown as below.

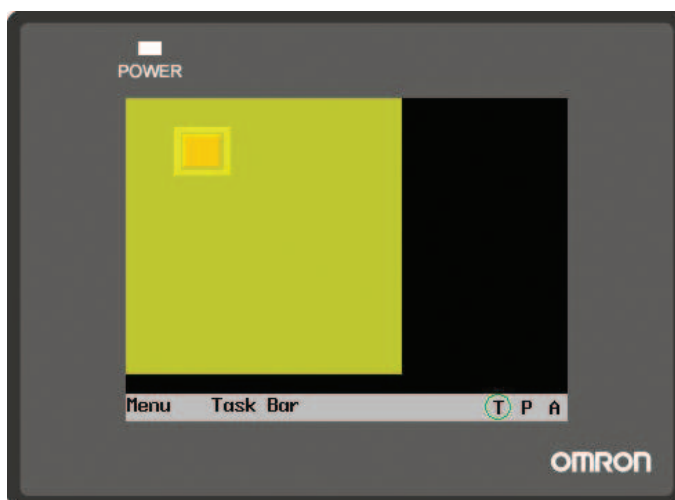

- When the transparency is 80%.

Perform the offline test and the effect is as shown below.

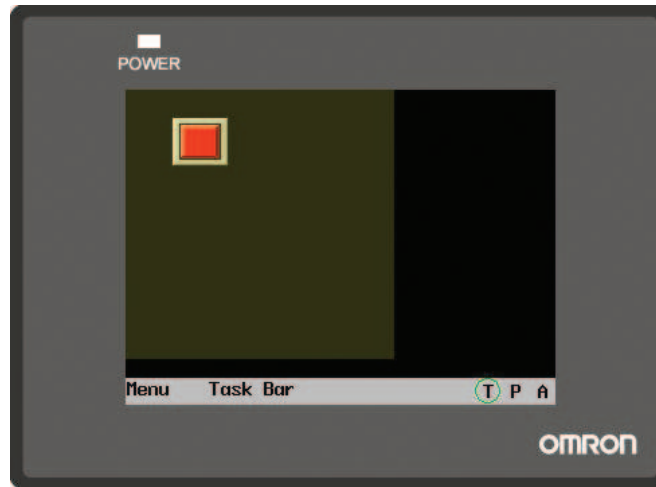



#### 3-4-3 Screen Creation

Clicking the  icon in [Screen Toolbar] can create a new screen.



#### 3-4-4 Screen Opening

After the screen is created, the previous screen can be displayed by selecting it in the pull-down menu in [Screen Toolbar] or by clicking the  icon, and the next screen can be displayed by clicking the  icon. If the mouse with the roller is used, the screen No. can be changed directly by using the roller.

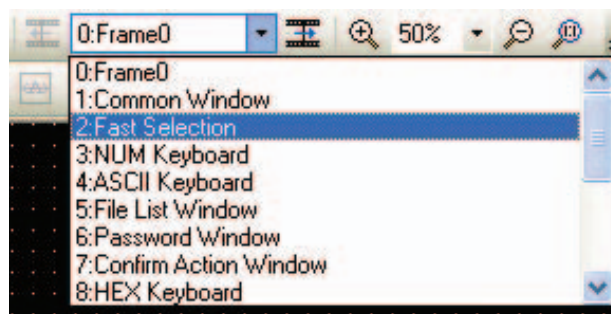

### 3-4-5 Screen Deletion

In Project Work Space, select the screen No. to be deleted, and press the “Delete” key in the keyboard or click the  icon in [Screen Toolbar]. When the Confirm Screen pops up, select “Yes” to delete this screen, and all the components in this screen will be deleted and can’t be restored. Please be careful when you use this function.

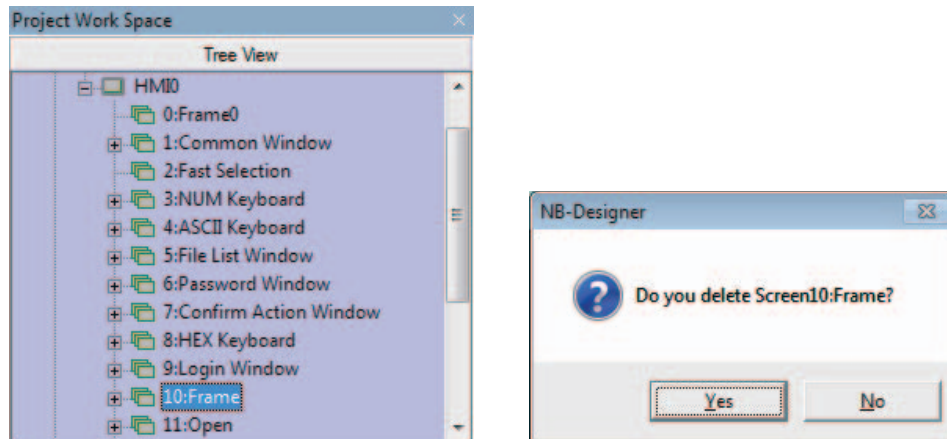

**Note** Frame 0, Frame 1 to Frame 9 are all the default screens for the system, and they are not allowed to be deleted.

### 3-4-6 Components Related to Screen

The function keys which are directly related to the screen operations include: Change Screen, Backward, Change Common Screen, Pop-up Screen and Change Menu Screen. Components which are directly related to the screen operations include: Direct Screen and Indirect Screen. For the contents of these components, refer to 3-6-16 *Indirect Screen* (Page 3-147) and 3-6-17 *Direct Screen* (Page 3-150) in *NB-Designer Operation*.

## 3-5 Basic Design Method

### 3-5-1 Designing Components

Generally speaking, one screen includes various kinds of components such as switches, lamps, number input and shapes. It is simple to add one component to the screen, and it is basically divided into 3 procedures as shown below.

#### ● Component Addition

- 1** Drag the component icon from [Project Library Window]-[Parts] to the Edit Window.
- 2** When the Property dialog box of this component appears, set the various Properties for this component such as PLC Read/Write Address, Vector Graphics or Bitmap, Label and Position etc.

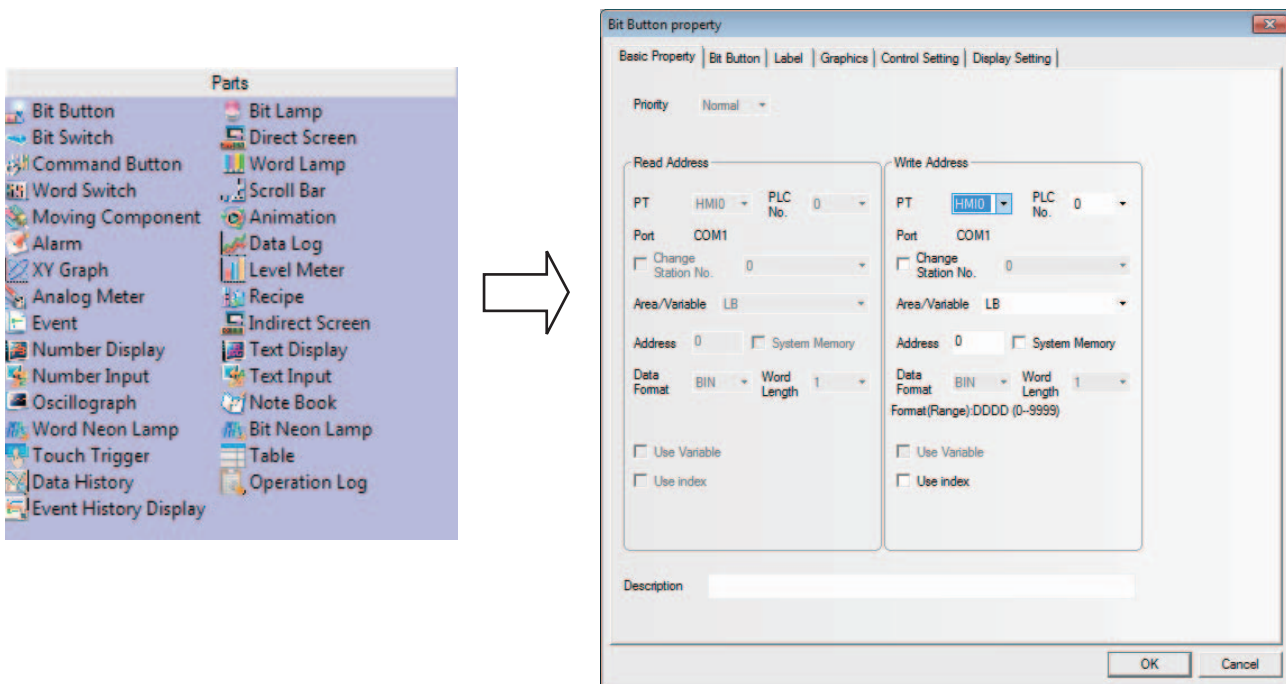

- 3** After the various Properties of this component are set, click the [OK] button. And you can see this component has been placed in the screen after exiting from this dialog box. If required, you can adjust the size of the component by changing settings in "Position" in "Display Setting" tab or drag it to the desired position.

### 3-5-2 About ID No.

ID No. is the number automatically assigned to the component for differentiating the components on the PT. The designer cannot change component ID number artificially.

The contents represented by ID No. are as follows:

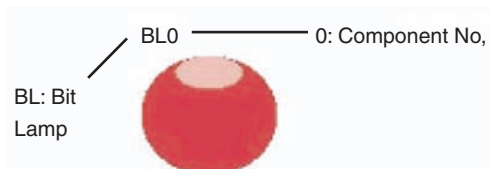

#### Parts:

SB: Bit Button

BL: Bit Lamp

SW: Bit Switch

DW: Direct Screen

SWD: Command Button

WL: Word Lamp

MSW: Word Switch

SCR: Scroll Bar

MV: Moving Component

ANI: Animation

AD: Alarm

TR: Data Log

XY: XY Graph

BR: Level Meter

MT: Analog Meter

RCP: Recipe

ED: Event

IDW: Indirect Screen

ND: Number Display

TD: Text Display

NI: Number Input

TI: Text Input

OS: Oscillograph

NB: Note Book

NL: Word Neon Lamp

BNL: Bit Neon Lamp

TT: Touch Trigger

GR: Table

HDD: Data History

**Function Parts:**

- SC: Scale
- FK: Function Key
- AB: Alarm Display
- TM: Timer
- BG: Bitmap
- VG: Vector Graphic
- NP: Notepad
- DT: Data Transmission
- VM: Freeplotting
- DTM: Date/Time Display
- DG: Indirect Shape
- UID: User Information
- CO: Multifunction
- EB: Event Display

### 3-5-3 Additional Comments (Descriptions)

If necessary, you can add comments to each component. The comments are used for entering remarks or descriptions of the program on creation. Therefore, the descriptions entered as the comments will be referred in future or the text entered will be used to describe when the text is printing. The entered comments will not cause any effects to the program. (The NB-Designer does not support comment printing.)

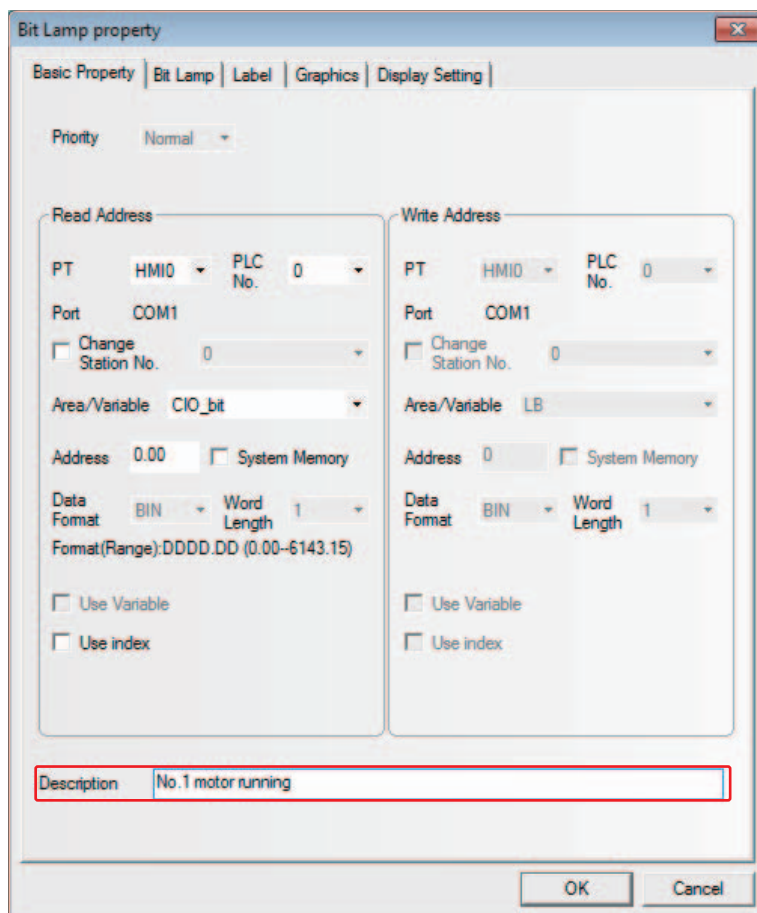

### 3-5-4 Read/Write Address for PLC

The correct area and address range vary with the PLC. In the following figure, PLC0 is manufactured by OMRON, while PLC1 is manufactured by SIEMENS, so their addresses are different.

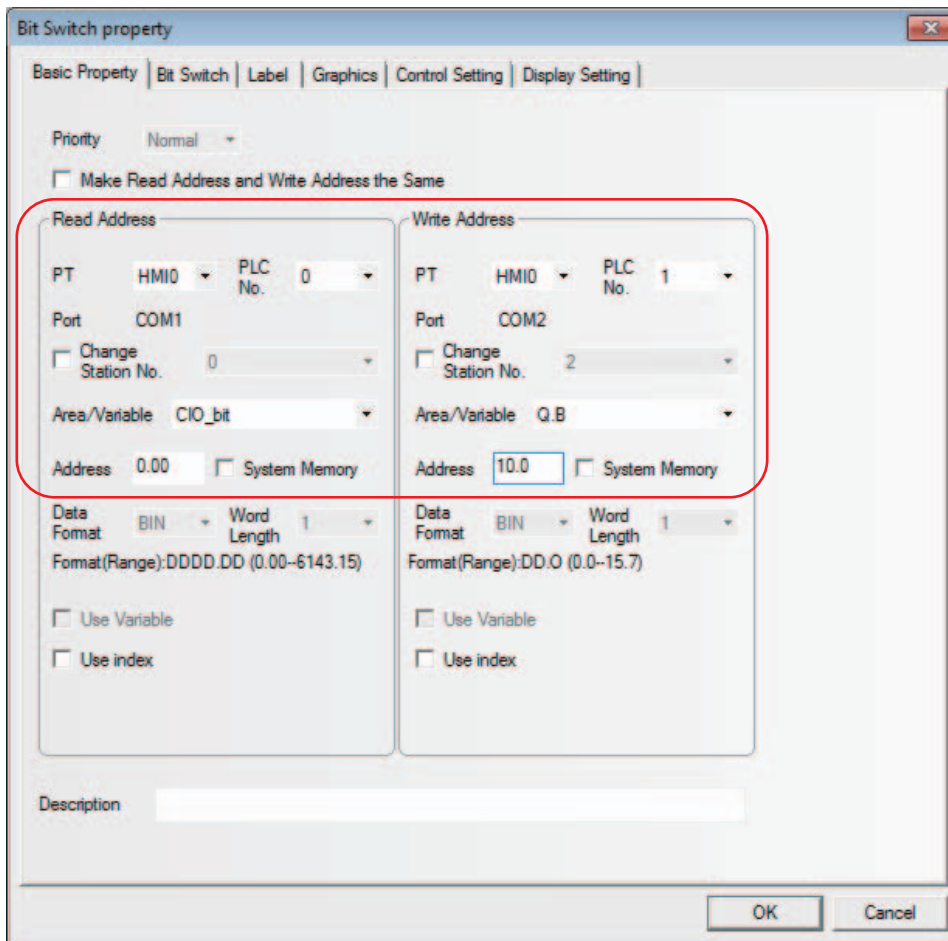

All the available PLC devices can be displayed in the pull-down menu corresponding to “PLC No.” option.

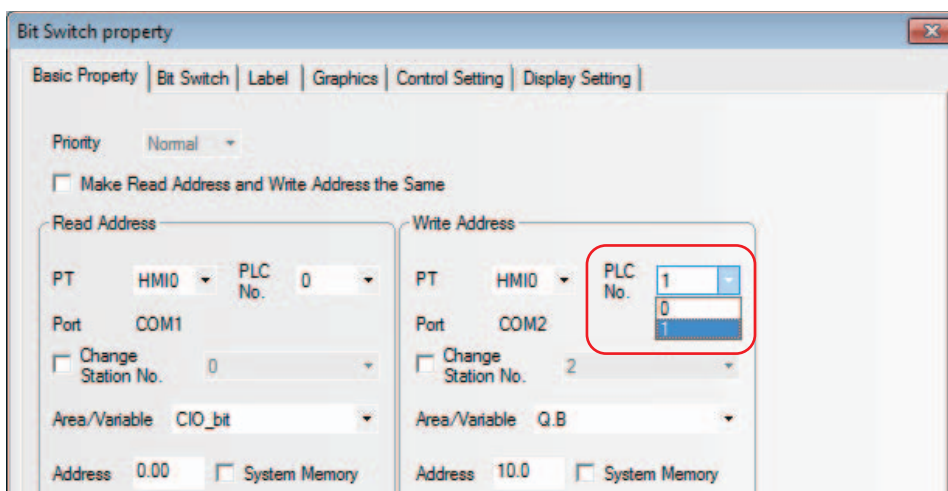

The internal memory can be also selected, And the descriptions of internal memory are as follows:

Type	Device Name	Range	Descriptions
Bit	LB	0~9999	The address of the local memory
Bit	RBI	0.0~261000.F(*1)	The index address of the recipe memory that is stored in the flash memory in D.H. format and H ranges from 0 to 15.
Bit	RB	0.0~261000.F(*1)	The absolute address of the recipe memory that is stored in the flash memory in D.H. format and H ranges from 0 to 15.
Bit	FRB	0.0~134217727.F	The absolute address of the flash memory in D.H. format and H ranges from 0 to 15.
Bit	FRBI	0.0~134217727.F	The index address of the flash memory in D.H. format and H ranges from 0 to 15.
Bit	LW.B	0.0~10255.F	The address of the local memory in D.H. format and H ranges from 0 to 15.
Word	LW	0~10255	The address of the local memory
Word	RWI	0~261000(*2)	The index address of the recipe memory that is stored in the flash memory
Word	RW	0~261000(*2)	The absolute address of the recipe memory that is stored in the flash memory
Word	FRW	0~134217727	The absolute address of the flash memory
Word	FRWI	0~134217727	The index address of the flash memory

**RB** and **RW** point to the same area. For example, **RB5.0~RB5.15** and **RW5** map the same area, i.e. **RB5.0** is the **Bit0** of **RW5**. But the addresses pointed by **LB** and **LW** in the memory are different, because they map the different areas.

The memory addresses of **LB9000~LB9999** in **LB**, **LW.B9000.0~LW.B10255.F** in **LW.B**, and **LW9000~LW10255** in **LW** are reserved by the system internally for some special purposes, and the users can't use them as the addresses for the common devices, but should use their special functions according to the related manuals. For details, refer to *3-11 Address of System Memory (Page 3-328)* in *NB-Designer Operation*.

When the recipe memory is accessed by the index address, the index address will begin to search from the address of the offset of the address displayed by **LW9000**. For example: If **LW9000** is **50**, the index address **RWI100** will access the data in the address of **RW150 (100+50)**. (For details, refer to *3-12 Recipe Data (Page 3-342)* in *NB-Designer Operation*.)

\*1 When using NB3Q-TW01B or NB5Q-TW01B, the range of addresses is 0.0 to 130500.F.

\*2 When using NB3Q-TW01B or NB5Q-TW01B, the range of addresses is 0 to 130500.

### 3-5-5 Vector Graphic

NB-Designer provides the powerful Vector Graphics and bitmap library, and you can create any desired graphics (such as switch, lamp, piping etc.) in the library and even you can add your own pictures to the library. The graphics can be 256-color bitmap, 16-color bitmap, 32-color bitmap or in JPG, BMP, GIF and PNG format. Every vector graphics or bitmap can create 256 statuses. The created Vector Graphics and bitmap are in [Graphics] in [Project File Window], as shown below:

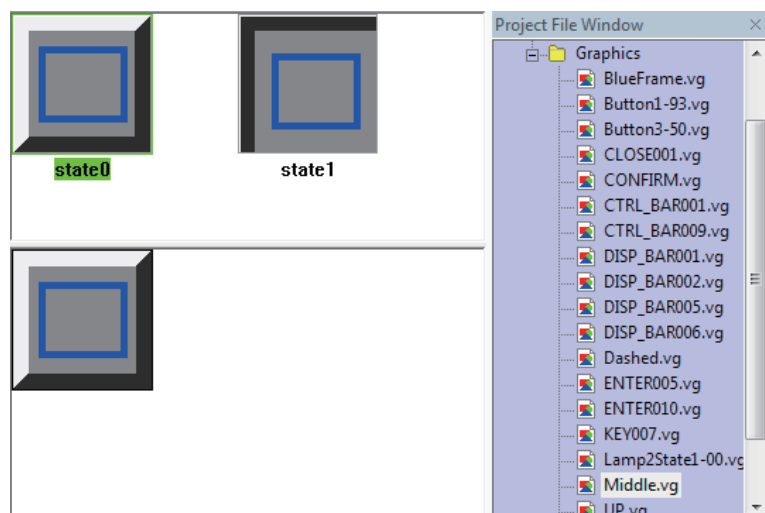



Of course, you can use the graphics library provided by the system. When you click the  [Import Graphics] icon in the toolbar, the following dialog box will pop up:

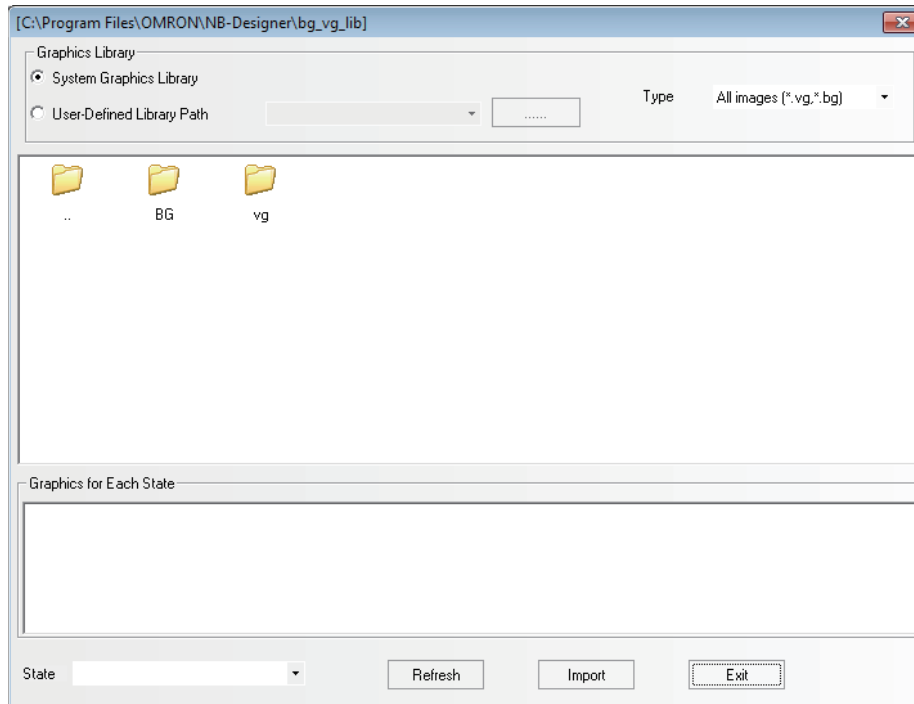

The system graphics library is located in `bg_vg_lib\VG` directory in which the NB-Designer was installed and all the graphics are stored in the folders for each item. Select the Vector Graphics to be imported, and click “Import”, then the Vector Graphics will be copied into the “vg” file of the current project. Importing multiple Vector Graphics or bitmaps simultaneously is not supported and only one graphics in the same folder can be selected at a time before “Import” is clicked. All the imported or created Vector Graphics or bitmaps by the user in the whole project will be displayed in the [Vector Graphic] in [Project File Window] to facilitate the user to view and use them.

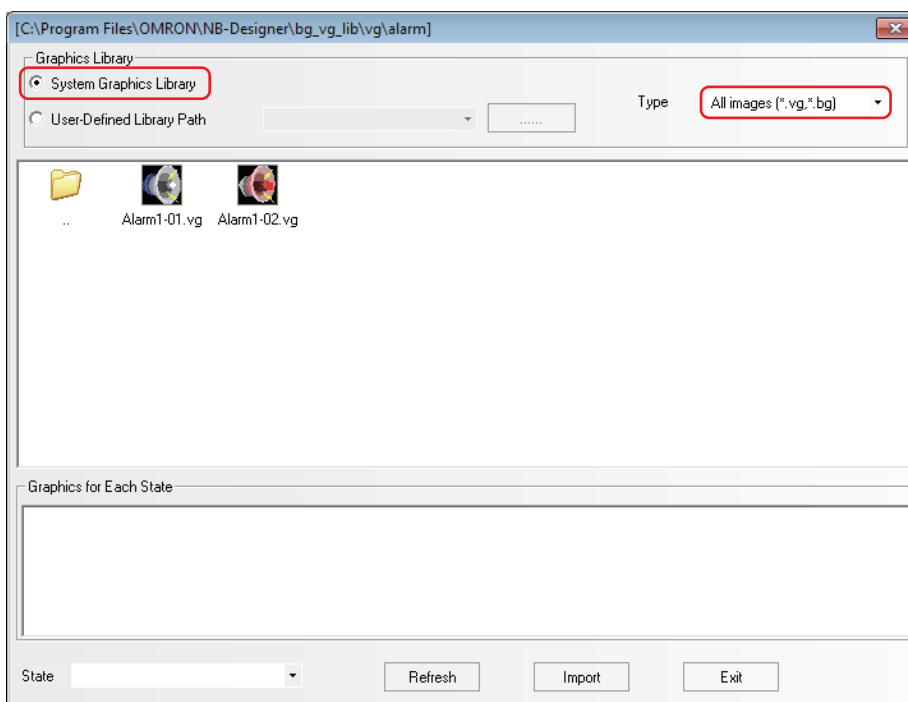

The vector graphics can be used as static images or the images representing the status of various components.

● Procedure of Vector Graphics addition

- 1 Select [Add Graphics] in the [Draw] menu or click  icon in the toolbar, and then the following dialog box will appear.

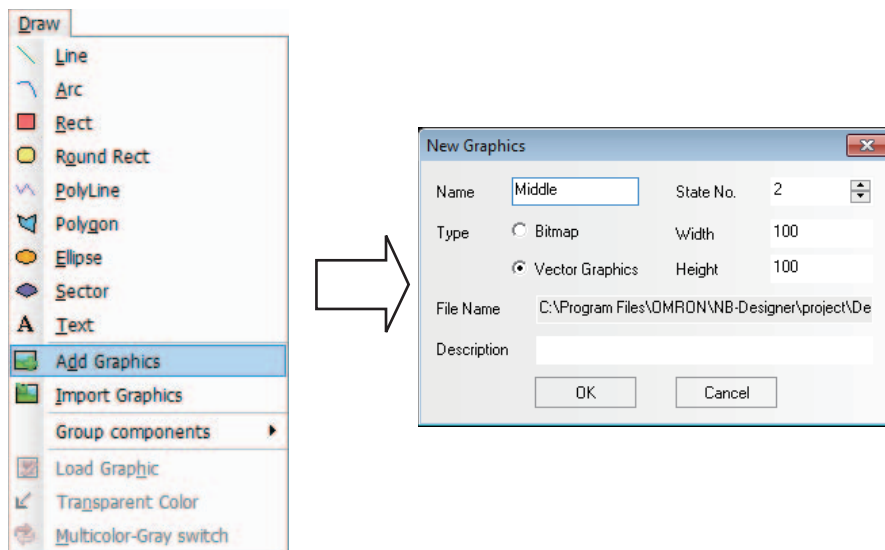

- 2 Input the Name, State No. and Description for the Vector Graphics (For example: To create a Vector Graphics with the name of “Middle” and the state No. of “2”), and click “OK”, then the following dialog box will appear:

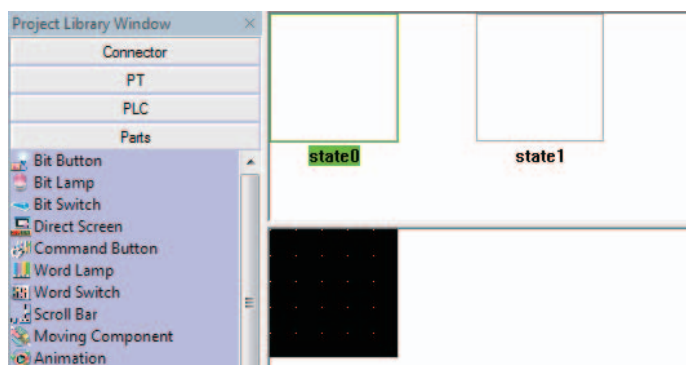

If you think the Vector Graphics states added just now are not enough, you can use the following methods to make addition:

Drag the mouse into State Preview Window of the Vector Graphics, select one state such as “state0”, then click  icon in the toolbar to create a new state. And the states that can be created are up to 256 kinds.

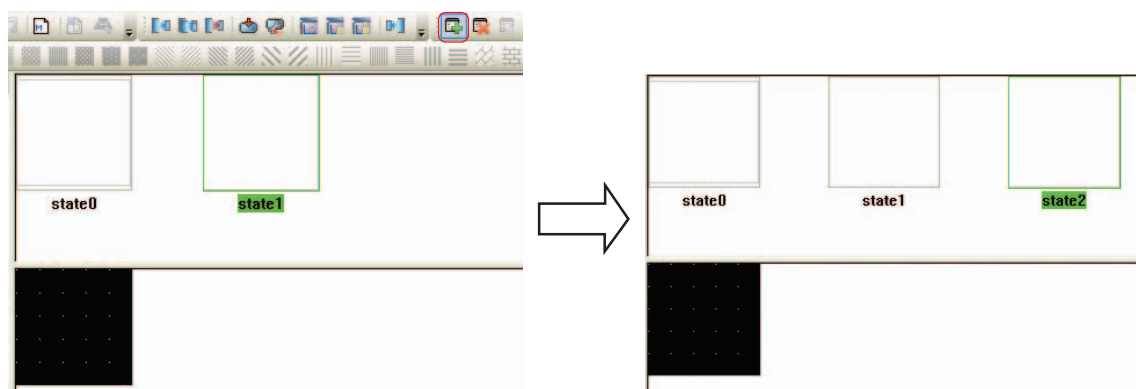

- 3** Create the graphics displayed in these two statuses, and then save the project.

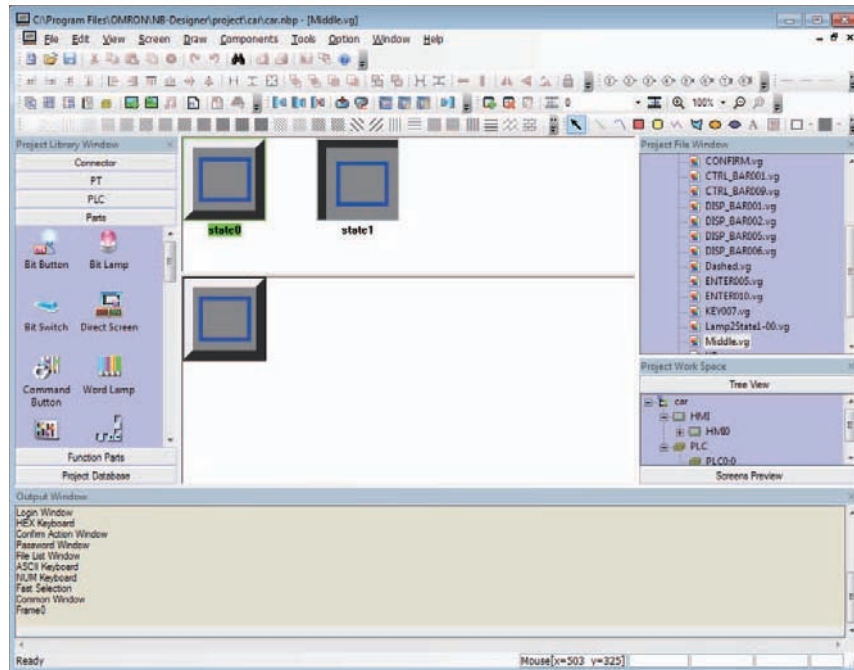

- 4** Go back to the Edit Window, and select one component, as shown below:



- 5** Check [Vector Graphics] in the [Graphics] tab of Bit Button Property dialog box, and find the name of the graphics created just now in the list, and then you can check the graphics at the specific status each.

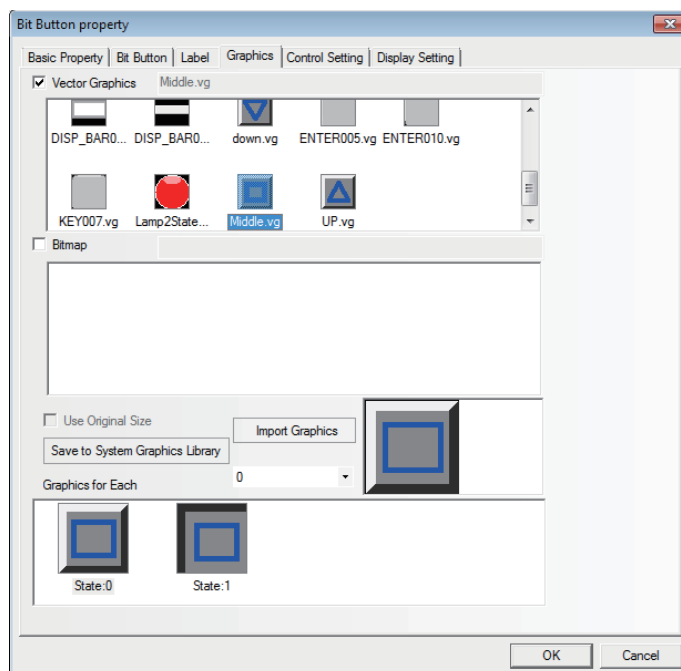

- 6 Click the [OK] button to exit from this dialog box, and this component will be displayed as the selected Vector Graphics and placed in the screen.



All the Vector Graphics imported into the project will be displayed in the [Project File Window].

If you want to modify any Vector Graphics or bitmap, you just need to find the graphics to be modified in the Vector Graphic in the Project File Window, and double-click it to open the Edit Window of this graphics, where you can modify the graphics drawn by yourself.

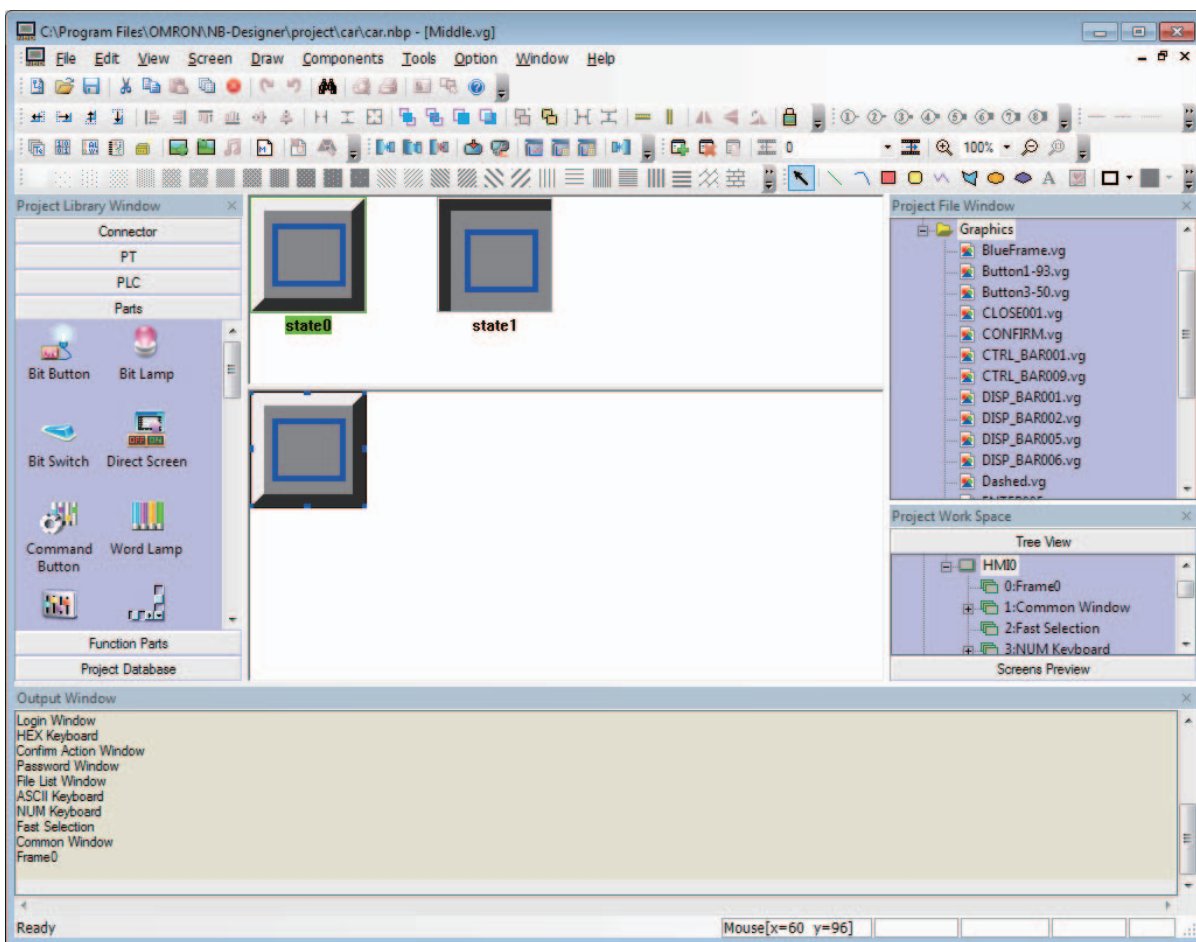

- Note 1** When the new graphics was created, the project should be saved to keep the contents. Otherwise the content will be lost.
- 2 No text can be added to the Vector Graphics.

### 3-5-6 Bitmap

One bitmap includes 256 kinds of states and the created bitmap can be used in the Edit Window. The bitmap is mainly applicable to graphic area, i.e. external graphics addition.

**Note** The operations (such as line-drawing, drawing, text addition etc.) for the bitmaps can't be made in the Graphics Edit Window, and only the external graphics addition can be done.

#### ● Procedure of bitmap addition

- 1 Select [Add Graphics] in the [Draw] menu or click  icon, and then the following dialog box will appear.

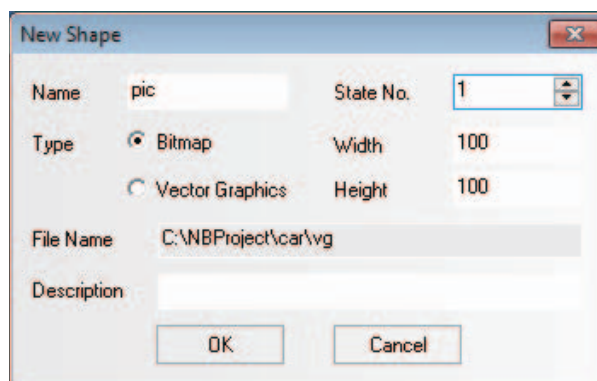

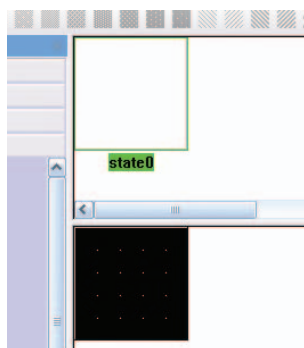

- 2 Select [Bitmap] in the "Type", and input "State No." and "Name", then click "OK".

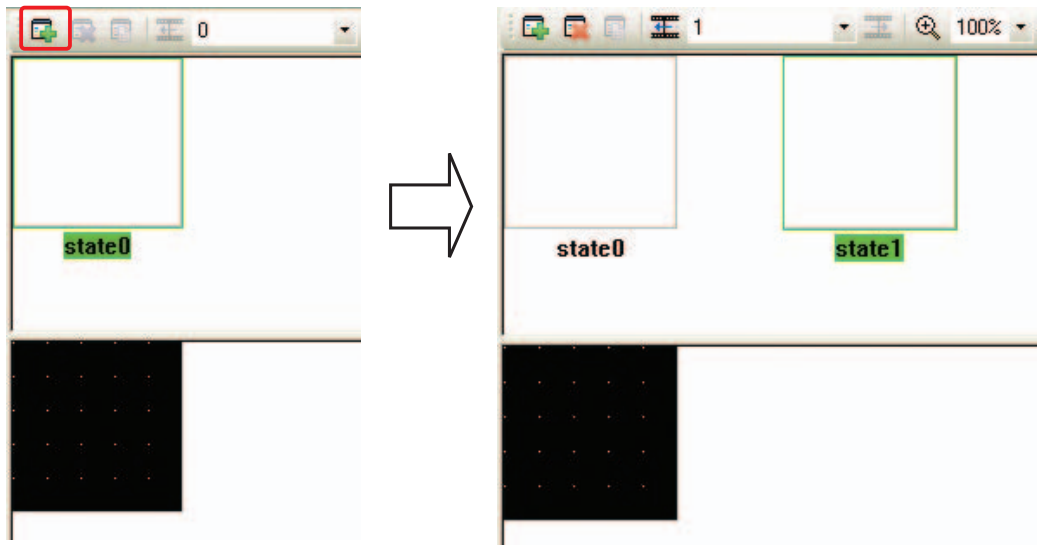

If you think the bitmap state added just now is not enough, you can use the following methods to make addition:

Drag the mouse into State Preview Window of the bitmap, select one state such as "state0", then click  icon in the toolbar to create a new state. And the states that can be created are up to 256 kinds.



- 3** Click [Draw Toolbar]  icon, find the needed graphics, and click it to open it. Only the pictures can be input into bitmap and the tools such as “Line” can’t be used in the bitmap, as shown below.

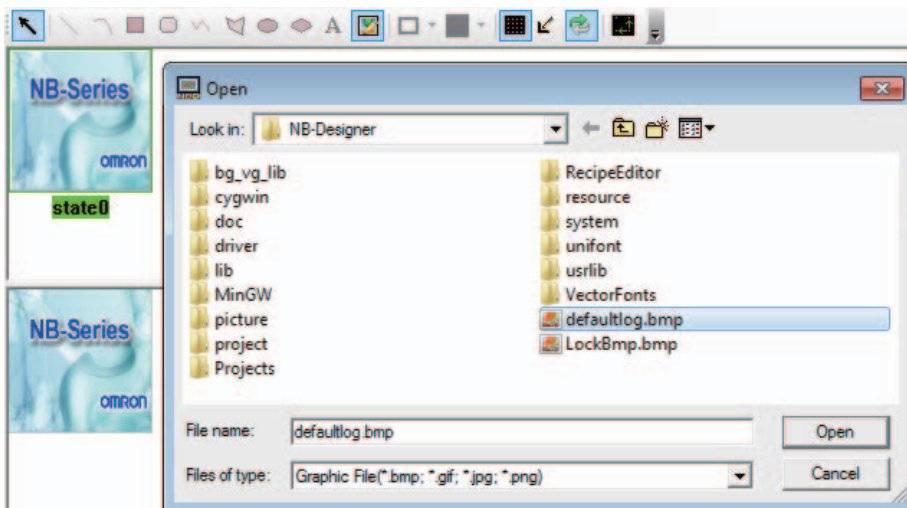

- 4** After the project is saved, you can use it through the bitmap component in the Edit Window.



## ● Use of Bitmap

- 1 Double-click the component where the bitmap will be used and then enter “Graphics” tab.

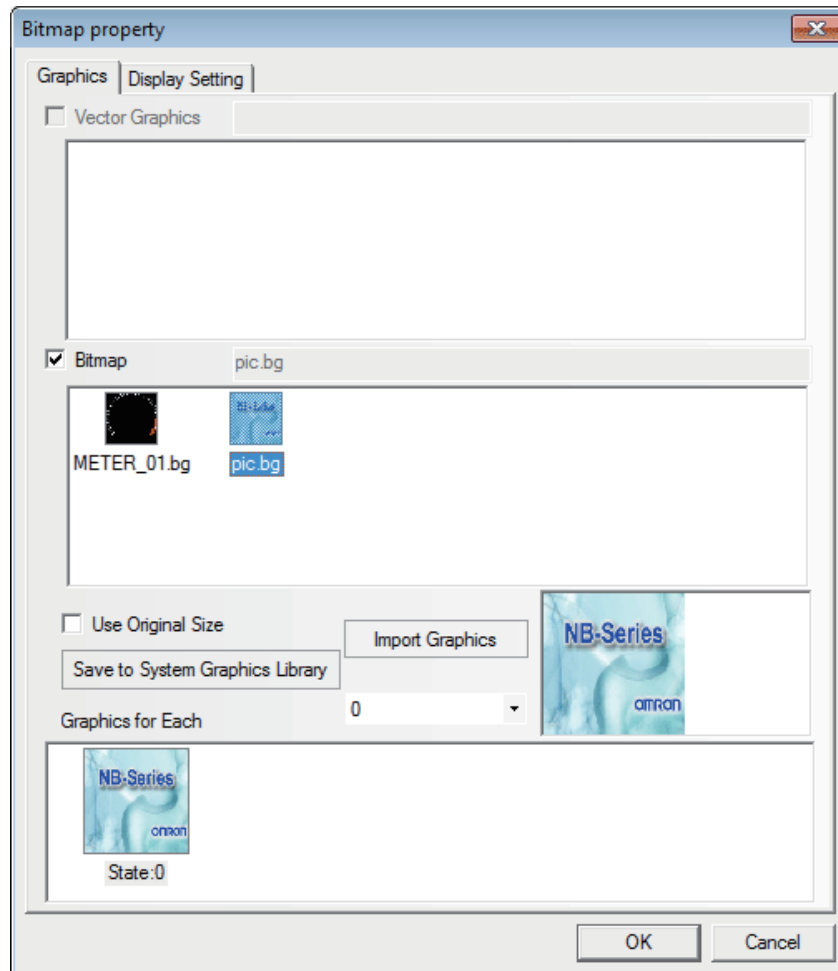

- 2 Check “Bitmap” option, and select the bitmap you want to use, then click “OK” button to close the dialog box.

## ● Import of Bitmap

- 1 You can import the bitmap just like importing the Vector Graphics. Click “Import Graphics” icon , and select “Bitmap image (\*.bg)” in the “Type” in the pop-up dialog box. You can also import the bitmap used in the other project or the System Graphics Library. The system graphics library is located in bg\_vg\_lib\VG directory in which the NB-Designer was installed and all the graphics are stored in the folders for each item.

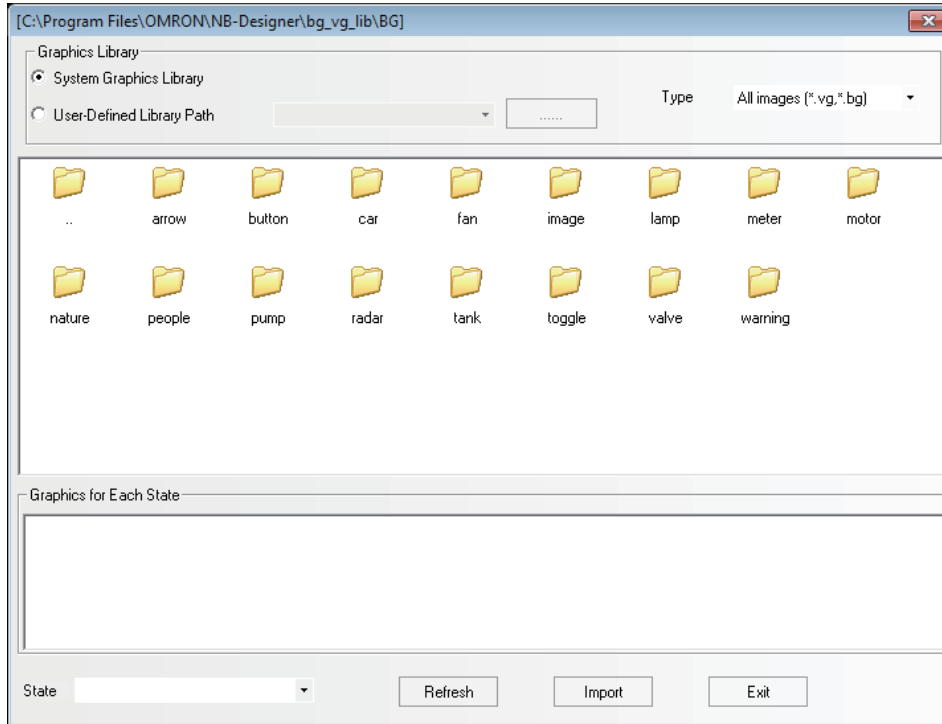

- 2** In the same project, the bitmap and the Vector Graphics are placed in the same location, i.e. “VG” folder under “Project File” folder. And all the imported bitmaps are stored in “project\

**Note** There is no limitations for the size of the graphics imported (BMP, JPG, GIF, PNG), and the graphics will be compressed according to the maximum used size (The maximum used size = Maximum length × Maximum Width in the project) during the compilation.

#### 3-5-7 Creating Label

Label refers to the text displayed in the surface of the components such as switch, lamp or the other components.



##### ● Label Addition

- 1** Select [Label] in the Property page of the selected component.
- 2** Check “Transport Font”.



- 3** As shown below, write the contents to be displayed for the label in [Message].

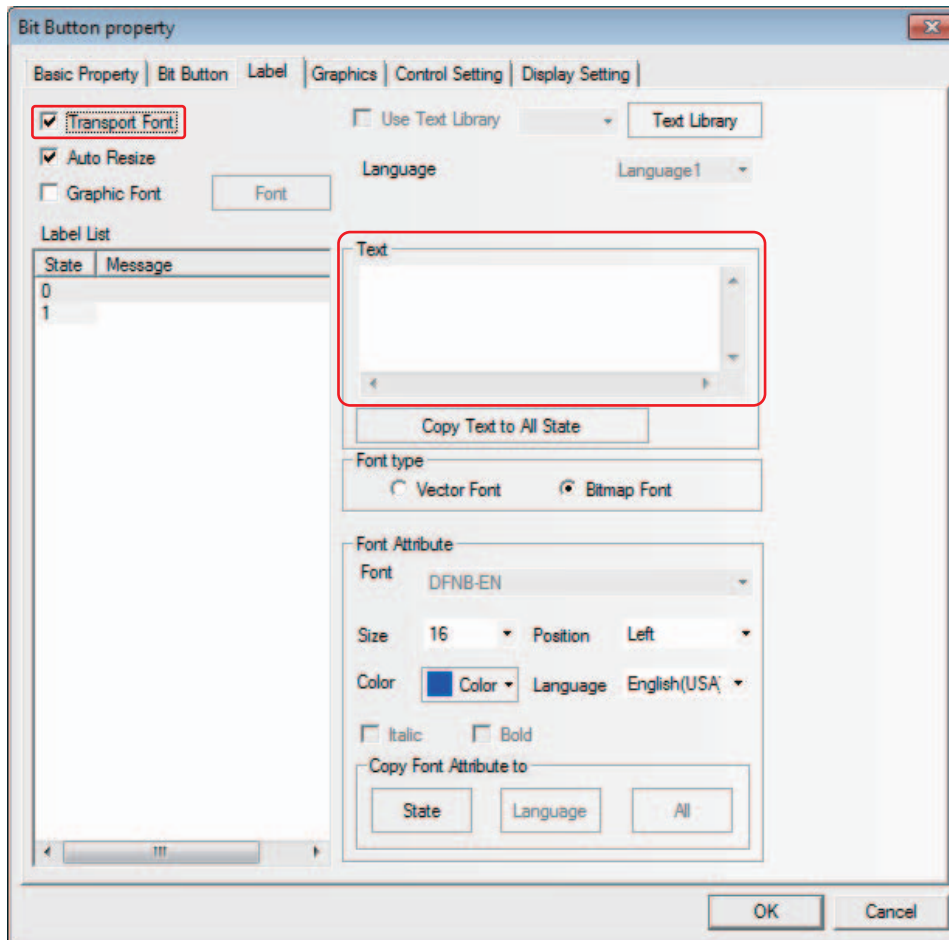

- 4** Set the display Properties such as the alignment method, font size and color etc.

- 5** Press the [OK] button to complete the setup.

#### ● State Number

State number is only effective for the component with multiple states. The text for every state can be displayed independently. The text, font, color and alignment method for the corresponding state can be set after the state is selected.

#### ● Message

Input the text to be displayed in the component surface here. If there are several lines, you can use "Enter" key to break them.

#### ● Font Size

The size of Bitmap Font is as follows: 8, 16, 24, 32, 48, 64, 72, 96, 120 and 144 pixels.

#### ● Position

When the input text for the label is 2 lines or more, Left, Right or Center can be selected for the alignment between the upper line and the lower line.

● **Color**

You can select color among 40 colors (65536 colors, which include supplementary colors). “Default Color” palette contains the most commonly-used colors. “Custom Color...” palette allows the users to customize the palette (65536 kinds of colors available).

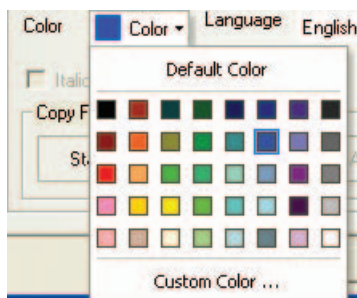

**3-5-8 Task Bar and Operation Buttons**

NB-Designer provides a simple method (i.e. the Task Bar) to make the screen pop up or be minimized, to change the display of the screen and fast switch the screen display etc.

Task Bar has 2 operation buttons, one of which is used to control the Menu Screen, and the other is used to control the Task Bar.

You can set the Properties such as the Task Bar, whether to use the Menu Screen, color and position and so on in the [PT Property] in the Configuration and Setup Window. (By default, all the options in the Display Task Bar are checked.)



If “Menu Screen” is checked, one Menu Screen will pop up when the Menu Screen button at the left side is pressed. Function keys put in the Menu Screen allow the different screen switched. Because the Menu Screen is always displayed on all of the screens, therefore it can be operated at any time. If you want to switch to a certain screen, it just needs to press the function key pointing to the destination screen once, thus avoiding the boring process of looking for the screen.

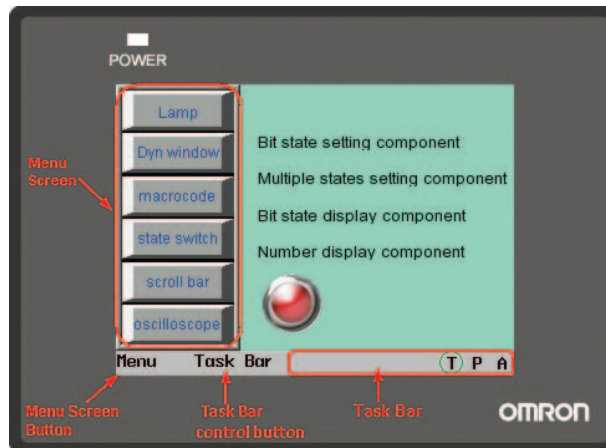

In the task bar, 16 icons can be arranged at the same time. The functions keys of [Minimize] or [Title Bar in Pop-up Screen] included in Pop-up Screen allow the screens to minimize in the task bar. For details, refer to 3-7-2 Function Key (Page 3-201) in NB-Designer Operation.

### ● Process of Operation Button Setup

Double click PT in the Configuration and Setup Window. Then the PT Property dialog box will appear, and set [Display Task Bar], whether the operation button will locate in the left side or right side of the screen, the background color and the text position method of the taskbar in [Task Bar] tab. If the label isn't displayed completely, you can adjust the width or the height of the button area and the font size of the label to solve this problem.

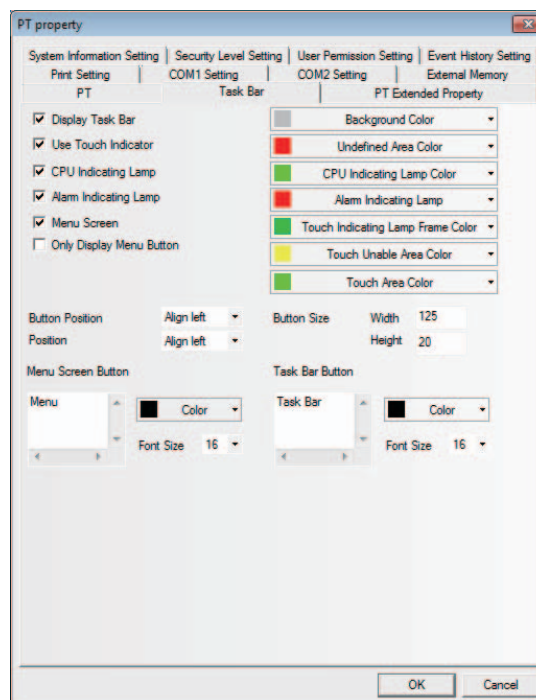

**Note** The Menu Screen is displayed on the left side or the right side of the panel during the operation. In edit window state, the Menu Screen is an independent screen, and it is Frame 2 by default. For details, refer to 3-10-2 Task Bar (Page 3-294) in NB-Designer Operation.

### 3-5-9 Fonts

#### ● Type and Characteristics of Font

NB-Designer provides 3 available fonts, i.e. Bitmap Font, graphic font and vector font. The characteristics of these three fonts will be described as follows:

#### Bitmap Font :

One bitmap font is prepared for each character. But this method has obvious disadvantages:

- (a) Only SimSun is supported.
- (b) The scaling effect is poor. For each character, 3 kinds of bitmaps (i.e. 8×8, 16×8, 24×16(height × width)) are reserved respectively, so the effect is very poor when the larger font is displayed, as shown below:

Font size	16	24	32	48	64	72
Example	123	123	123	123	123	123

- (c) Single-byte character may be treated as double-byte character. ASCII code is treated as a single-byte character, but the other character are converted to double-byte character in the software. Therefore, a character varies in its width for each character (such as Russian) cannot be displayed correctly.

καλώς ορίσατε!

Therefore, this method has the obvious disadvantages for the project with multiple languages.

#### Graphic Font:

Graphic font is converted to one bitmap and stored in the project. This method can make full use of the fonts installed in Windows and the display effect is good.

- (a) The capacity of the project becomes greater. There are 2 reasons for the large space needed for saving the character string as bitmap. First, bitmap format itself needs a large space. For example: Four characters “ 组态软件 ” displayed in Zero SimSun needs 1824 bytes, as shown below:

组态软件

In addition, the bitmap font should be intercepted again if the content, size or colors vary slightly, thus causing a linear increase in the occupied space.

When a character is converted as a bitmap, it is converted as the unit of character string, not the unit of the character. Even if a similar character is different with its content, font size, color, the character is converted as an individual bitmap. As the converted bitmaps are stored in the NB project file for each character string with different properties as above, the capacity occupied with the fonts should be increased in the project.

- (b) Text library or some component labels do not support the graphic font.

#### Vector Font:

The characters used for labels or supposed to be used in future are abstracted through specified fonts by NB-Designer. Only the abstracted characters are stored as True Type font (tff style) and can be used by the NB-Designer units.

Using vector font in NB-Designer can avoid the disadvantages of Bitmap Font and graphic font.

Vector font has the following advantages:

- (a) It supports a large variety of vector fonts. The TrueType font (only the font in ttf format) installed in the operating system can be used.
- (b) You can save the capacity of project file. It adopts the method of intercepting the matrix from the font file, thus reducing the capacity of the font file. For the same character in the same font, only one matrix needs to be intercepted regardless of the size, color, bold/italic styles.
- (c) Rich font styles are available. Bold and italic styles are available for each kind of font.
- (d) The font size can be set freely without any deformation. You can set the consecutive font sizes without any projections.
- (e) It supports powerful multiple languages. You can use it to set fonts for each state and each kind of language of the text.
- (f) The vector font can be used in the text library.

### ● Use of Vector Font

The functions and components related to the vector font are as follows:

#### 1 Text Library

Using the text library can realize the reuse of the text and the multi-language project.

The operation instructions related to the font:

- (a) Maximum language number setup

The maximum language number can be set up to 32. If smaller capacity of project file is preferable, set the maximum language number to the least necessary number.

- (b) Default font setup for each language

The user can set the default font for each language, and when the user uses the text library, he doesn't need to reselect the font each time.

#### 2 Text Component

Text component can display the character information statically. And the user can use the multi-language text when the text library is used.

- (a) The text component can use 3 kinds of fonts, i.e. Bitmap Font , graphic font and vector font.
- (b) In the text library mode, the text component can reset the font for each language by changing the language displayed currently.

#### 3 Label

Most of the components can use the label. The text string can be directly input and the text library can also be used in the component label.

- (a) When the text library isn't used, different fonts can be set for text string in each state.
- (b) When the text library is used, fonts can be set for the text string of each language and in each state.

#### 4 Component dealing with numbers

Number components include number input component and number display component.

After the vector font is set for the number input component, the content of the number input component will be displayed as vector font to realize the better display effect.

#### 5 Component dealing with text strings

Text components include text string input component, text display component and note book component.

- (a) Limitations to ASCII codes for the vector font: The text contents used for the component dealing with text string often can't be decided during the compilation of the project, and due to the limitations to the storage capacity, all the characters that may be used can't be downloaded to the PT. Therefore, these components can only use ASCII characters (The matrix information supporting all the ASCII characters for this font have been downloaded to the PT by the software.) when using the vector font.
- (b) Unicode character encoding. When the Bitmap Font and the Unicode are selected simultaneously, you can use the function key to input Unicode character to the text input component.

## 6 Time Component

Time component can display the information such as year, month, day, hour, minute, second and week etc. of the current system in the simplest way.

When the vector font is selected, the time will be displayed according to the set vector font.

## 7 List and Drop-down List

List and drop-down list options are available for selection in the Word Switch component, and in such state, the label for the component is listed as the list. Similarly, fonts can be set for each language and each state.

## 8 Alarm and Event Information

Alarm and event information component can also set different vector fonts for each piece of alarm information and for each language (When the text library is used.) respectively.

### ● Use of Font Toolbar

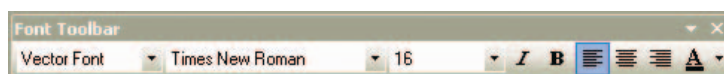

The software provides the toolbar for convenient font operation. When you select one or more components, you can use the font toolbar to change the font Properties of the related components. Please pay attention to the following conditions:

- (a) The font attributes set through the toolbar for the **current state** and **current language**. If the attributes of other states and languages need to be changed, you can do it through the component dialog box or by changing the current state or the current language of the project, as shown below:



- (b) When multiple components are selected, if the component doesn't support a certain font attribute, the attribute of this component will not be affected by using the font toolbar to set the font attribute.

### ● Notes for Using Vector Font

Based on the special realizing method for the vector font, the following conditions should be paid attention to when the vector font is used:

- 1 If the font which is not supported for text to be displayed is used, the font cannot be displayed correctly.

For example, if you want to display four characters “ 组态软件 ” using Arial font, but because these four characters are not included in the Arial character set, so four square boxes will be displayed in this case, as shown below. Therefore, you must select the fonts supporting text to be displayed.



- 2** Use the vector font as much as possible if the smaller capacity of project file is preferable.

Because the Bitmap Font and graphic font have many disadvantages in the storage space and resizing etc, therefore, use the vector font as much as possible.

- 3** The types of the vector font can be reduced when the screen can meet the requirements.

If too many types of vector fonts (e.g. dozens or more) are used by the user, the number of font files will be too many, thus affecting the compilation speed, downloading speed and screen switching speed.

- 4** Install the same fonts for all the PC environments to edit text strings.

If a certain project uses “Microsoft Elegant Black” font when it is edited on PC, and when it is transferred to another PC where no “Microsoft Elegant Black” font exists for editing, then all the “Microsoft Elegant Black” characters used in the project will be changed to arbitrary font which is decided as optimal by the operation system.

**Note** When the font installed with Windows is used, use it only after confirming the font will not give rise to problems under the Copyright Law.

### 3-5-10 Basic Properties of Component

Basic Properties of Component		
Priority	It is pre-reserved for the function.	
Write Address	If the component supports read only, you cannot set to writing addresses. The status of the components will be displayed based on the reading addresses.	
	PT	Number of the controlled PT. The numbers are allocated automatically when the PT is placed on [Configuration and Setup Window].
	PLC No.	Number of the controlled PLC. The numbers are allocated automatically when the PLC is placed on [Configuration and Setup Window].
	Change Station Number	This option can be used to access the specific PLC during the communication with multiple PLCs. This option is applicable when editing only one PLC in the case one PT is connected with multiple devices or multiple PTs are connected with multiple devices.
	Area/Variable	Refers to the memory of PLC device to be controlled or the internal memory of the PT. For the internal address type of PT, refer to 3-5-4 Read/Write Address for PLC (Page 3-59) in NB-Designer Operation.
	Address	Specifies address to be written to.
	Data Format	The code type includes BIN, BCD, and LSB. When BIN or BCD code is used, it allows to display 256 of statuses at maximum and when LSB code is used, it allows to display 17 of statuses at maximum. (Refer to 10 LSB Type (Page 3-377) in the section 3-16 in NB-Designer Operation).
	Word Length	Refers to the number of the occupied memories. The default number is 1, and it varies with the different component or area/variable.
	System memory	Refers to the internal memories provided by the PT for some special purposes. For details, refer to 3-11 Address of System Memory (Page 3-328) in NB-Designer Operation.
	Format (Range)	Refers to the formats of the address types of the PLC memories or the internal memory address of the PT.
	Use Variable	Determines whether to use the addresses registered in the variables. For details, refer to 3-8-2 Variable Table (Page 3-244) in NB-Designer Operation.
Use the index memory	Determines whether to use the specified memory as the index memory for the control memory of the current component. The new [Read/Write Address] = the specified [Read/Write Address] + [Index Address]. For example, when the specified written address is D100 and the index memory address is LW0, if LW0=10, the new write address is D100+10=D110.	
Read Address	If the component supports write only, you cannot set to reading addresses. The status of the components will be displayed based on the writing addresses.	
Description	Refers to the reference name assigned to the current component (not displayed).	

### 3-5-11 Control Setting of Component

Control Setting of Component				
Option	Descriptions			
Touch Enabling Setting	Enable Input	Checking this option means the state value can be written into the controller by triggering the effective area for the current component.		
	Disable Input	Checking this option means the state value cannot be written into the controller even when triggering the effective touching area for the current component.		
	Conditional Enabling	Security Level: Checking this option means only when the security level of the operator is higher than the minimum security level already set, the current component can be touched, and the state value can be written into the controller.		
		User Permission Control: Checking this option means the operator must have the permission to touch the current component and write the state value into the controller.		
		Indirect reference: Checking this option means only when the state of the specified bit memory or word memory meets the set conditions, the current component can be touched, and the state value can be written into the controller.		
	Auto show login screen	Checking this option means the Password Input Screen Frame 9 (Login screen) will pop up automatically for the user to login when the security level or the permission of the current user doesn't meet the requirement of the set level or authority.		
Show Unable-to-Input	Checking this option allows Unable-to-Input figure will be displayed when the component is in invalid to input. This function is optional only when [Enable Input] or [Conditional Enabling] is checked; and touching invalid color can be set in [PT Property]-[PT Extended Properties].			
Security Setting	ON Delay	When the current component is pressed consecutively for this set time, the state value can be written only to the controller. The minimum unit is 100 ms. When this option is 0, this function is invalid.		
	Confirm Operation	Checking this option means the Confirmation Screen will pop up automatically when the current component is touched, and the state value can be written into the controller when "YES" is clicked, while the operation will be cancelled automatically when the user have clicked "Cancel" or haven't confirmed "YES" after the set "wait[s]" is exceeded.		
	Operation Log	Checking this option means the operation event will be recorded, and displayed through the operation log element.		
	Min Interval	Refers to the minimum interval between 2 operations for the same component or different components. The minimum unit is second. When this option is 0, the minimum interval is invalid.		
Triggering action	Macro	Checking this check box allows the macro which was specified before the current operation was completed will be triggered and executed. *		
	Write Notice	Word	Notice Before Written	Writes the write-value into the specified address before the current operation is performed successfully.
			Notice After Written	Writes the write-value into the specified address after the current operation is performed successfully.
	Bit	Bit	Notice Before Written	Writes ON/OFF signal into the specified address before the current operation is performed successfully.
			Notice After Written	Writes ON/OFF signal into the specified address after the current operation is performed successfully.

\* Please refer to 3-9-3 Macro Triggering (Page 3-273) in NB-Designer Operation.



● Example of Control Setting

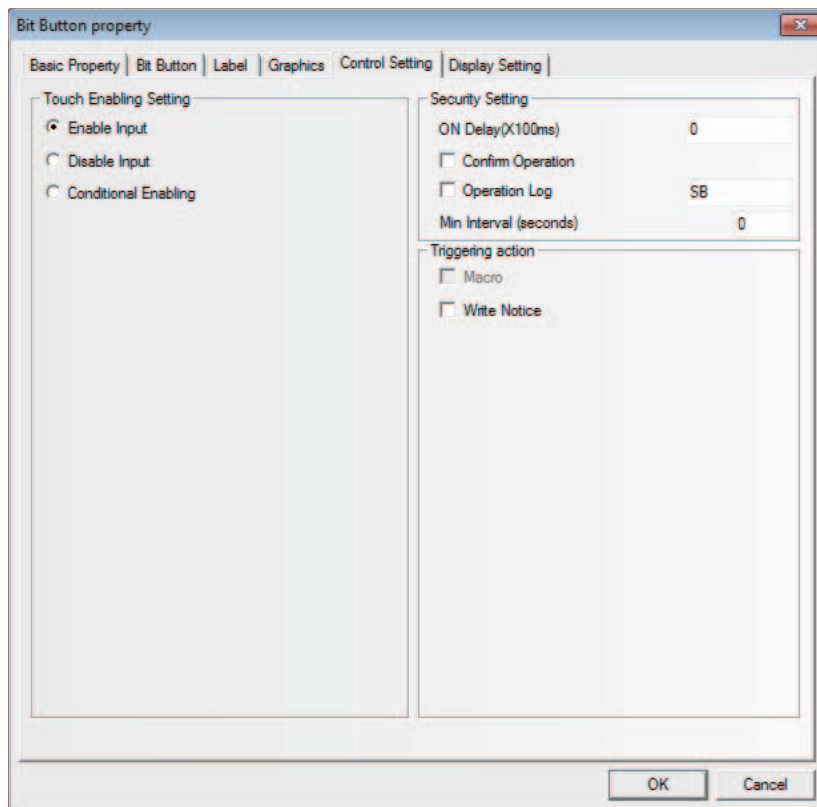

Example: Setting the parameters as below to enable the value input to LW0 when LB10 is ON.

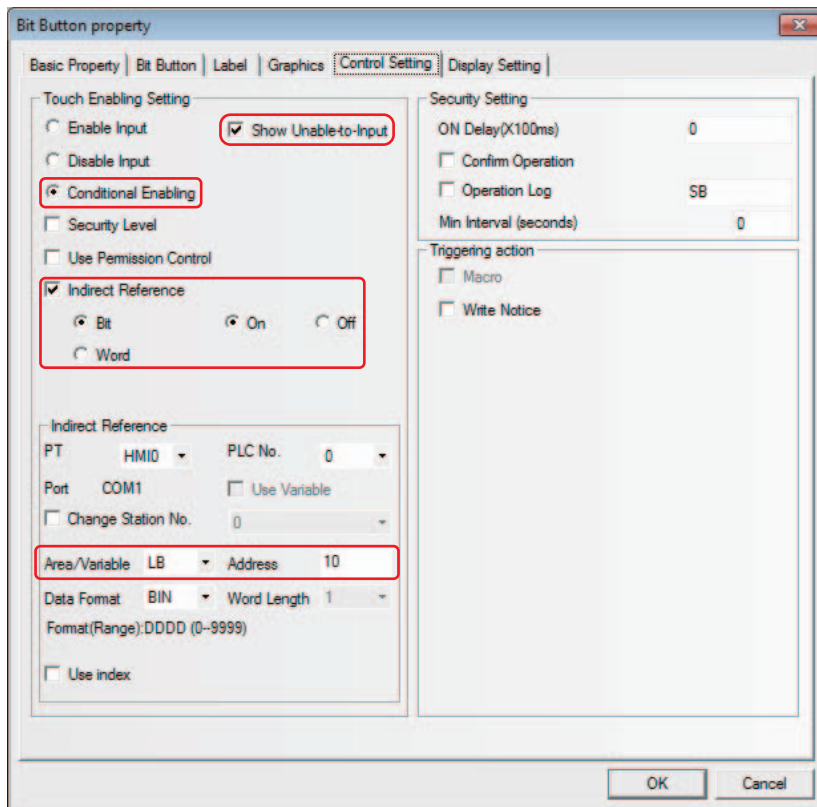

- 1 Perform the offline test. When LB10 is OFF, the input by the number input component is invalid, and the icon indicating [Unable-to-Input] is displayed, as shown in the following left graphics.
- 2 When LB10 is ON, the input by the number input component is valid, and the icon indicating [Unable-to-Input] isn't displayed as shown in the following right graphics.

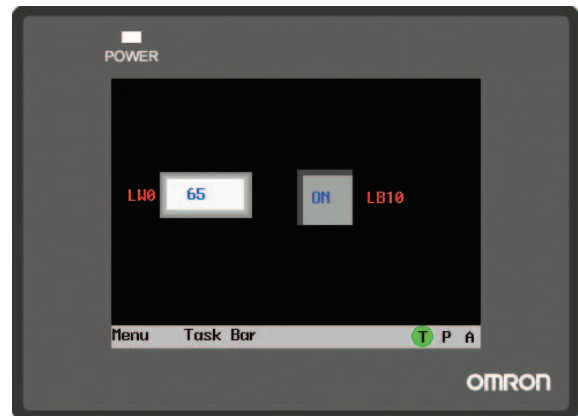

● Example of Security Setting

Example: Set LW0 to the address of number input component, check Operator Confirm, and select 10 s for “wait[s]”.

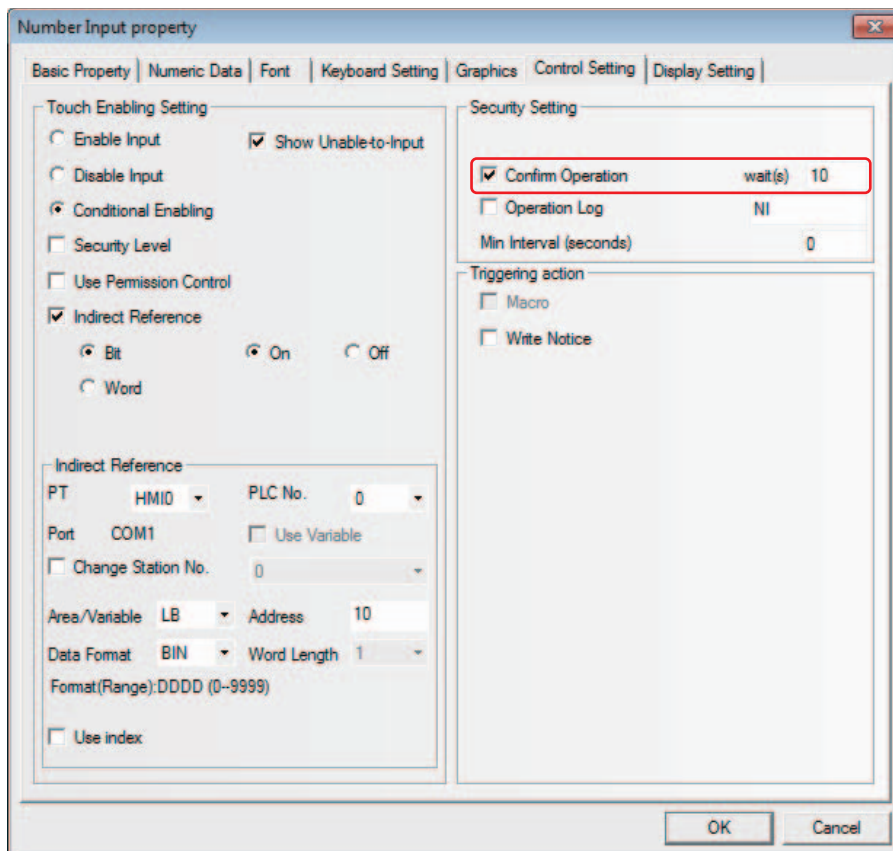

Perform the offline test. Operate the number input component, and the Confirm Screen will pop up during the confirmation operation. In this case, press “Yes” to input the data successfully, press “Cancel” to cancel the input. If 10 seconds pass without pressing “Yes” nor “Cancel”, the Confirmation Screen will disappear automatically.

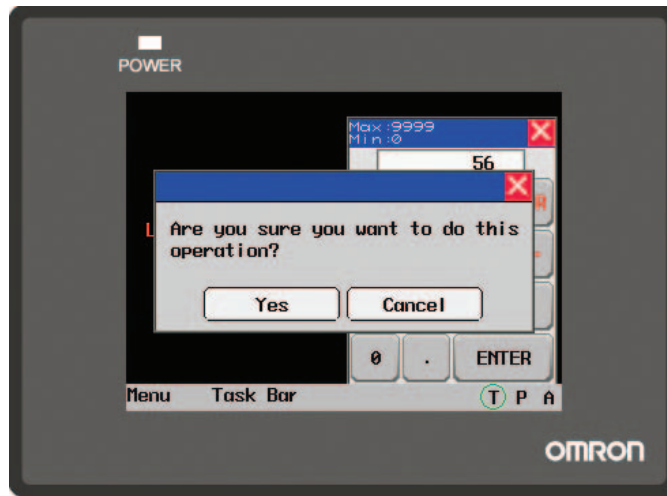

● Example of Notifications

**Example:** Set LW0 to the address of number input component. Set After Written Notice as LB10 is ON after writing the address.

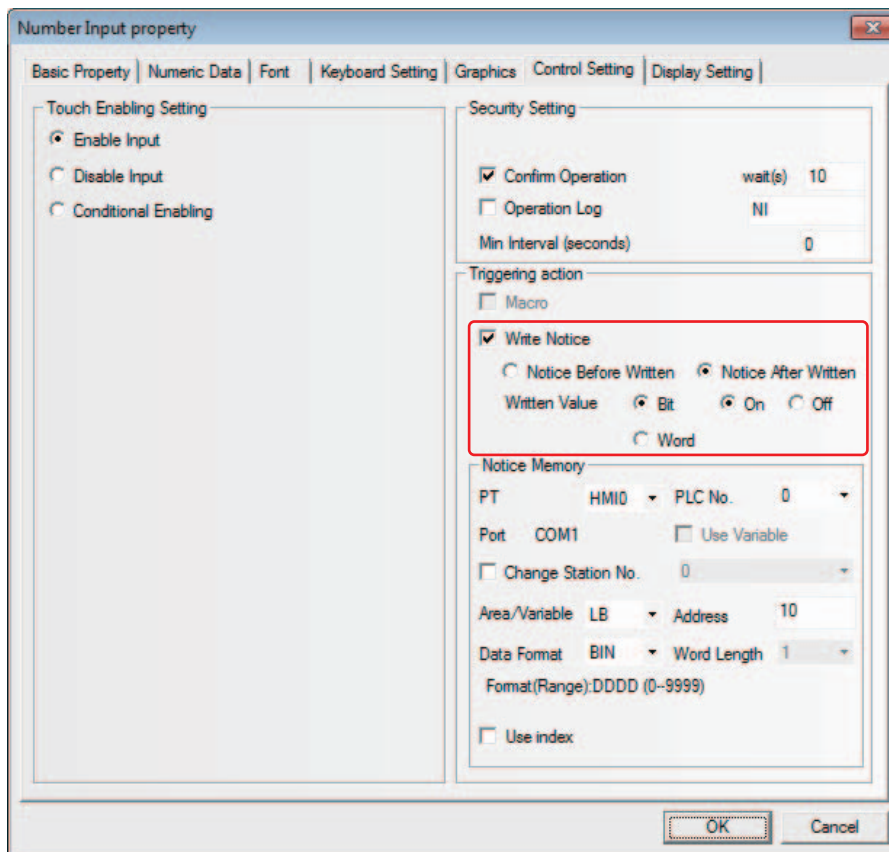

Perform the offline test. And when no data is written into the number input component LW0, LB10 is “Off”, as shown in the following left graphics.

When the data is written into the number input component, LB10 is “On”, as shown in the following right graphics.



### 3-5-12 Display Setting of Component

Display Setting for Component	
Lock Position	Checking this option means the component is locked. Once the component is locked, it can't be moved by the mouse or the moving keys in the keyboard.
X/Y	Refers to the coordinate value of the vertex in the upper-left of the component.
Width/Height	Refers to the width and height of the component (The unit is pixel point).
Display	Checking this option means the current component is always in displayed state.
Not Display [Touching is invalid]	Checking this option means the current component is always in “hide state” and the touching is invalid when the component is hidden.
Conditional Display	Security Level Control: Checking this option means the current component can be displayed only when the security level of the operator is higher than the minimum security level already set.
	User Permission Control: Checking this option means the current component can be displayed only when the operator has the set permission.
	Indirect Reference: Checking this option means the current component can be displayed only when the state of the specified bit memory or word memory meets the set conditions.

● Example of Display Setting

**Example:** Set LW0 to the address of number input component make display setting and keep LB10 as “On”.

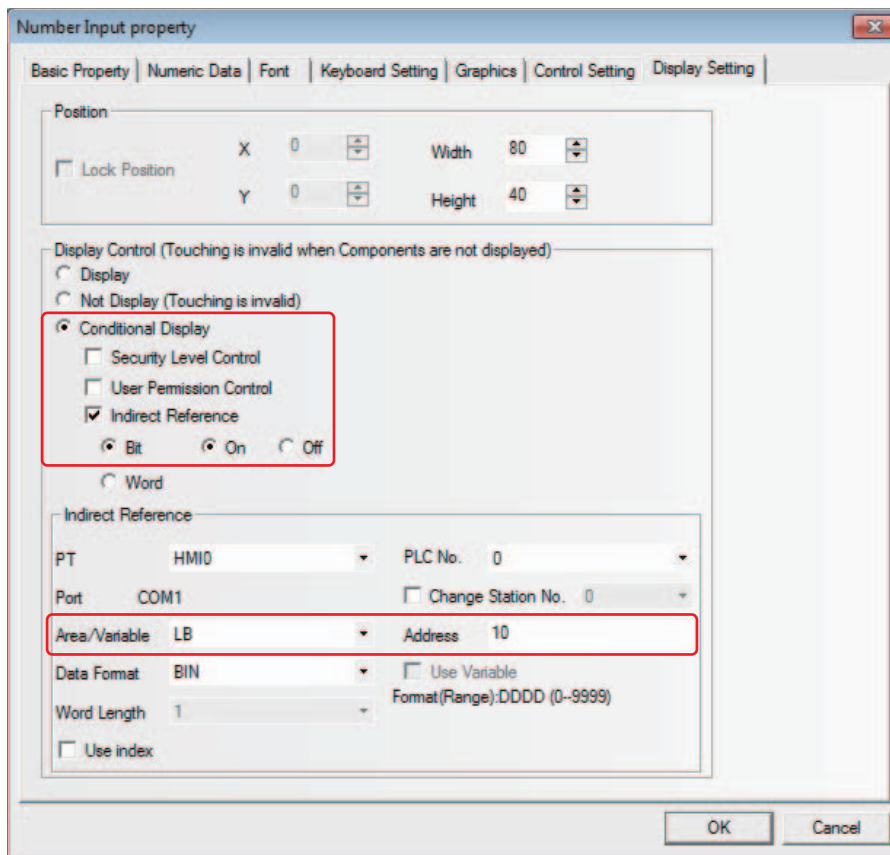

Perform the offline test. When LB10 is Off, the number input component is hidden, as shown in the following left graphics.

When LB10 is On, the number input component is displayed, as shown in the following right graphics.

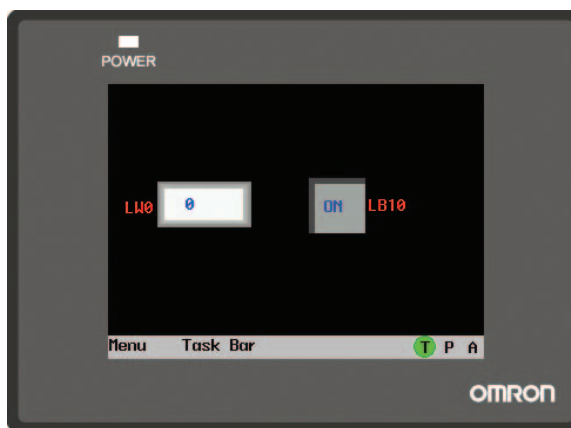
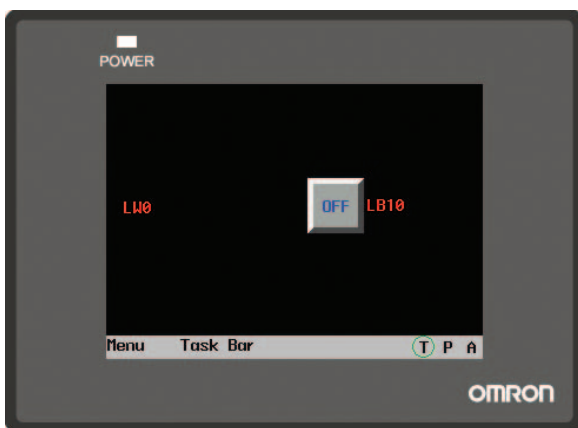

## 3-6 Parts

Parts are designed to meet specific needs. Generally speaking, one component can realize one function, but some components should be combined with the related components or PLC to realize some specific functions, as shown below.

Components	Related Components	Descriptions
Number Input	Function Key	To create the keyboard by "Function Key"
Text Input	Function Key	To create the keyboard by "Function Key"
Indirect Screen	Screen	The created "screen"
Direct Screen	Screen	The created "screen"
Alarm Setting	Alarm, Alarm Display	To display the registered alarm information by "Alarm" or "Alarm Display"
Alarm	Alarm Setting	To display the alarm information registered by "Alarm Setting" component
Alarm Display	Alarm Setting	To display the alarm information registered by "Alarm Setting" component
Event Setting	Event	To display the registered event by "Event" component
Event	Event Setting	To display the event registered by "Event Setting" component
PLC Control	PLC	To make PLC program control the operations of the functions

Most of the PLC part support "bit" or "word" addresses ("Double-word" operation can be performed by some components such as Number Input and Scroll Bar etc. Due to some PLCs have "double-word" addresses, so some PLC drivers will make conversion between "double-word" and "word", and the user must pay special attentions to the instructions of PLC driver.

### 3-6-1 Bit Button

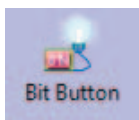

Bit Button component defines one touching area. When this area is activated, the bit address inside the PT or in the PLC can be switched to "On" or "Off" forcefully.

## ● Process of adding one Bit Button component

- 1 Drag the Bit Button component after it is pressed will make the [Basic Properties] of Bit Button component pop up.

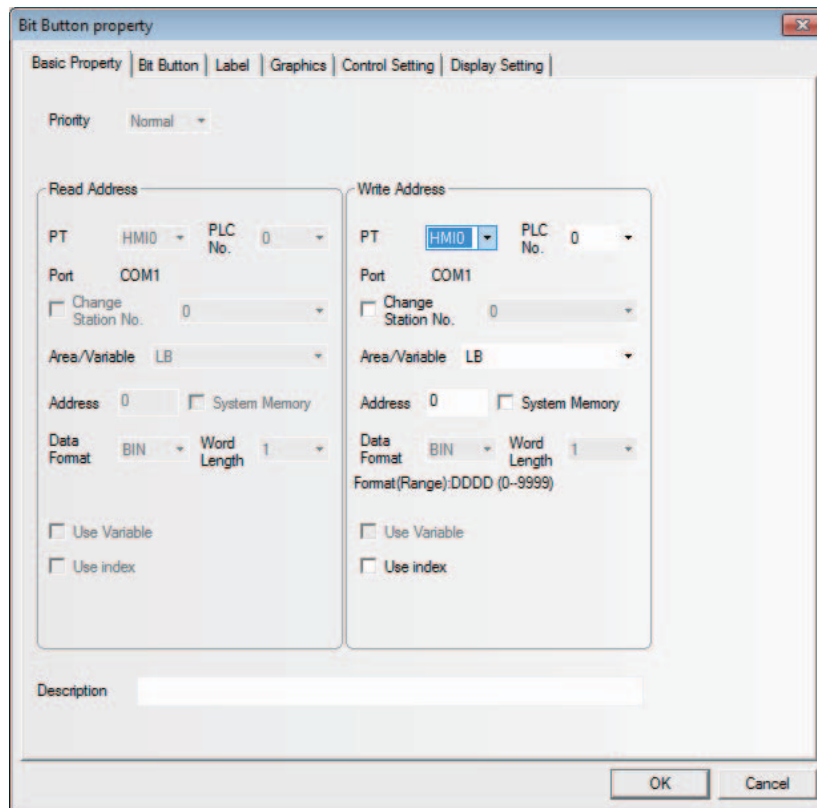

**Write Address:** Refers to the bit address corresponding to “On” or “Off” state controlled by the Bit Button component.

- 2 Switch to the [Bit Button] tab.

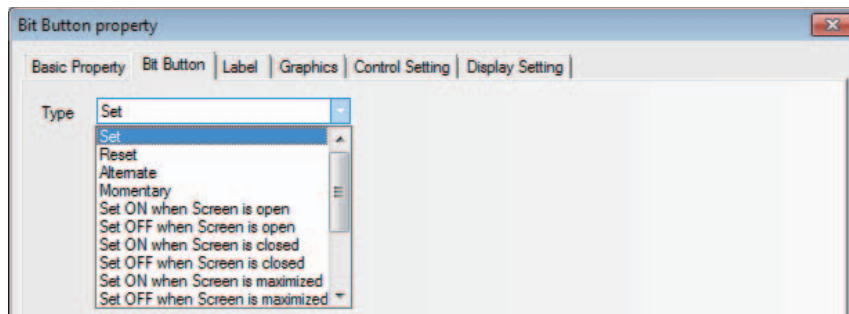

### Types and Functions of Bit Button Component

Type	Descriptions
Set	The specified bit address will turn On when the Bit Button component is pressed. This state will continue even if the button is released.
Reset	The specified bit address will turn Off when the Bit Button component is pressed. This state will continue even if the button is released.
Alternate	The specified bit address will change once (On→Off, Off→On) (Switched back and forth) when the Bit Button component is pressed each time.
Momentary	The specified bit address will turn On only when the Bit Button component is being pressed. Similarly, the bit address will turn Off when the component is released.

Type	Descriptions
Set On when Screen Open	The specified bit address will turn On when the screen containing the Bit Button component is opened.
Set Off when Screen Open	The specified bit address will turn Off when the screen containing the Bit Button component is opened.
Set On when Screen Close	The specified bit address will turn On when the screen containing the Bit Button component is closed.
Set Off when Screen Close	The specified bit address will turn Off when the screen containing the Bit Button component is closed.
Set On when Screen Maximized	The specified bit address will turn On when the screen containing the Bit Button component is maximized.
Set Off when Screen Maximized	The specified bit address will turn Off when the screen containing the Bit Button component is maximized.
Set On when Screen Minimized	The specified bit address will turn On when the screen containing the Bit Button component is minimized.
Set Off when Screen Minimized	The specified bit address will turn Off when the screen containing the Bit Button component is minimized.
Set On when Backlight Off	The specified bit address will turn On when the screen containing the Bit Button component is displayed in the screen and the backlight is Off.
Set Off when Backlight Off	The specified bit address will turn Off when the screen containing the Bit Button component is displayed in the screen and the backlight is Off.
Set On when Input Success	The specified bit address will turn On when the input using one Number Input component in the screen containing the Bit Button component is successful.
Set Off when Input Success	The specified bit address will turn Off when the input using one Number Input component in the screen containing the Bit Button component is successful.

- 3** Switch to the [Label] and add the text corresponding to the state.
- 4** Switch to [Graphics] tab and select the Vector Graphics or bitmap representing the touching area and touching state.
- 5** Switch to the [Control Setting] tab and make the Security Setting and set the Triggering action.

**Min Interval (seconds):** Refers to the interval between 2 valid touching operations for the same component, and the default is 0 s.

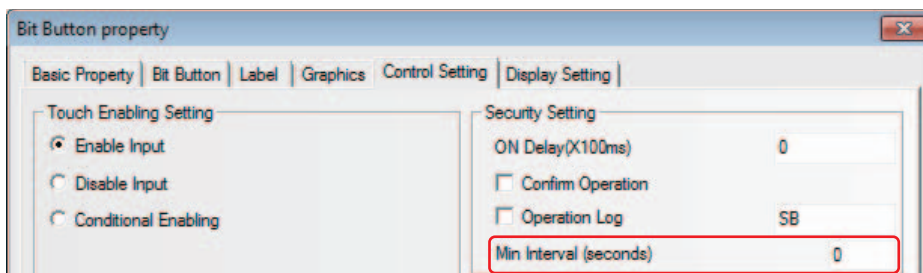

- 6** Switch to the [Display Setting] tab and adjust the position and size for the Bit Button component.
- 7** Press the [OK] button to complete the setup of Bit Button component.



## 3-6-2 Bit Lamp



Bit Lamp displays the On/Off state of bit address inside a specified PT or of PLC device. If the state is 0, the graphics with state of 0 will be displayed; If the state is 1, the graphics with state of 1 will be displayed. If "Transport Font" is checked, the Label values corresponding to the different states can be set and displayed.

### ● Process of adding one Bit Lamp

- 1 Drag the Bit Lamp icon after it is pressed, then the [Basic Properties] dialog box for Bit Lamp component will pop up.

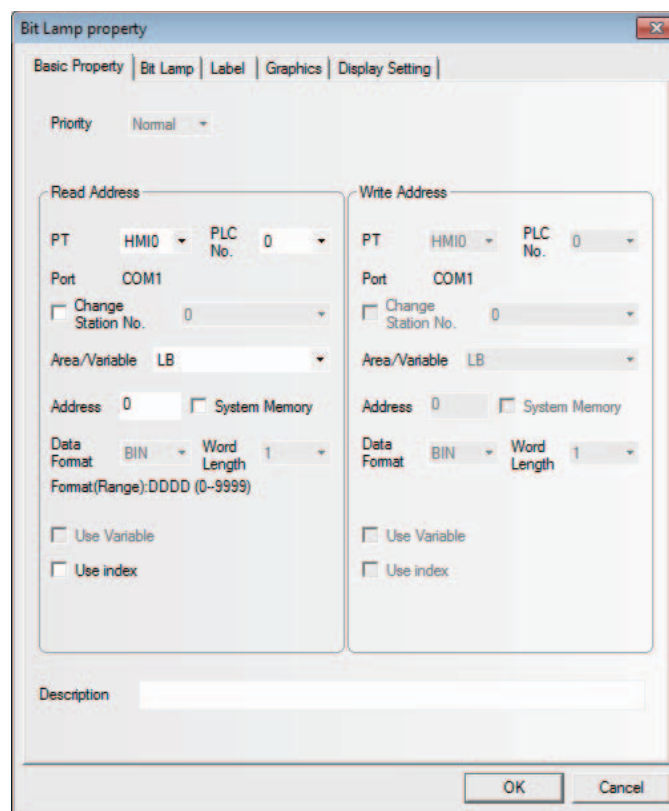

**Read Address:** Refers to the bit address controlling the displayed information (such as the state, graphics, label and so on) of the lamp.

**Address:** Refers to the bit address corresponding to the lamp.

- 2 Switch to the [Bit Lamp] tab.

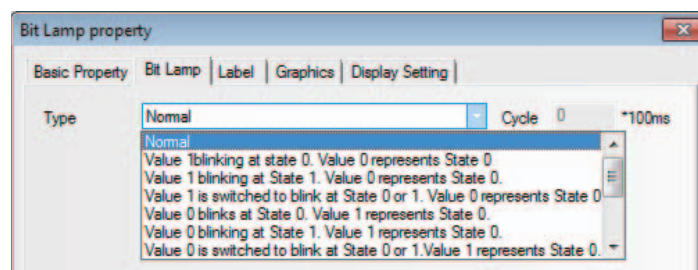

**Function:**

Blinking rate is set in “Cycle” box with the unit of 100 ms (If the rate is set to 500 ms, both ON time and OFF time of the Bit Lamp are 500 ms.).

Function	Address State of Bit to Be Read			
	ON (value 1)		OFF (value 0)	
	Display (Blink/Not Blink)	State No.	Display (Blink/Not Blink)	State No.
1	Not Blink	1	Not Blink	0
2	Blink	0	Not Blink	0
3	Blink	1	Not Blink	0
4	Not Blink	Switching between 0 and 1	Not Blink	0
5	Not Blink	0	Blink	0
6	Not Blink	0	Blink	1
7	Not Blink	0	Not Blink	Switching between 0 and 1
8	Blink	0	Not Blink	1
9	Blink	1	Not Blink	1
10	Not Blink	Switching between 0 and 1	Not Blink	1
11	Not Blink	1	Blink	0
12	Not Blink	1	Blink	1
13	Not Blink	1	Not Blink	Switching between 0 and 1

- 3 Switch to the [Label] tab and add the texts corresponding to the On and Off states.

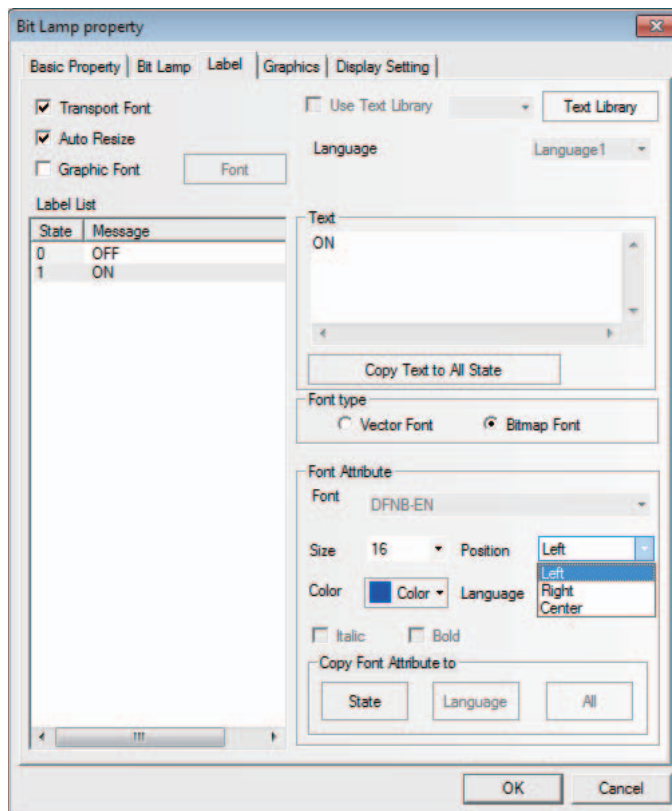

**State:** Off will be displayed when the lamp state is 0; while On will be displayed when the state is 1.

**Alignment:** Three methods are available, as shown below:

Left: The input content is put in the left side of the graphics.

Right: The input content is put in the right side of the graphics.

Center: The input content is put in the center of the graphics.

**Font Size:** Displays the size of the font used by the content input to “Message” and the following types are available.

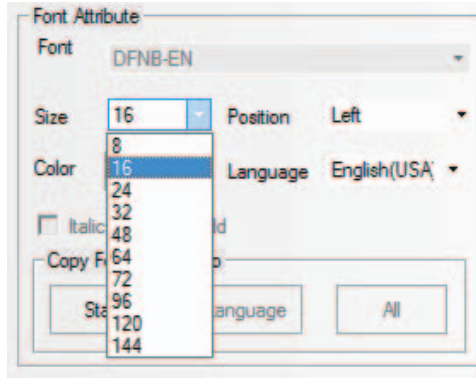

**Color:** Displays the colors of fonts used by the content input to “Message”, and the user can use “Custom Color...” to specify the desired colors.

- 4 Switch to the [Graphics] tab, and select Vector Graphics or bitmap to represent the graphics corresponding to the On and Off states of the bit address.

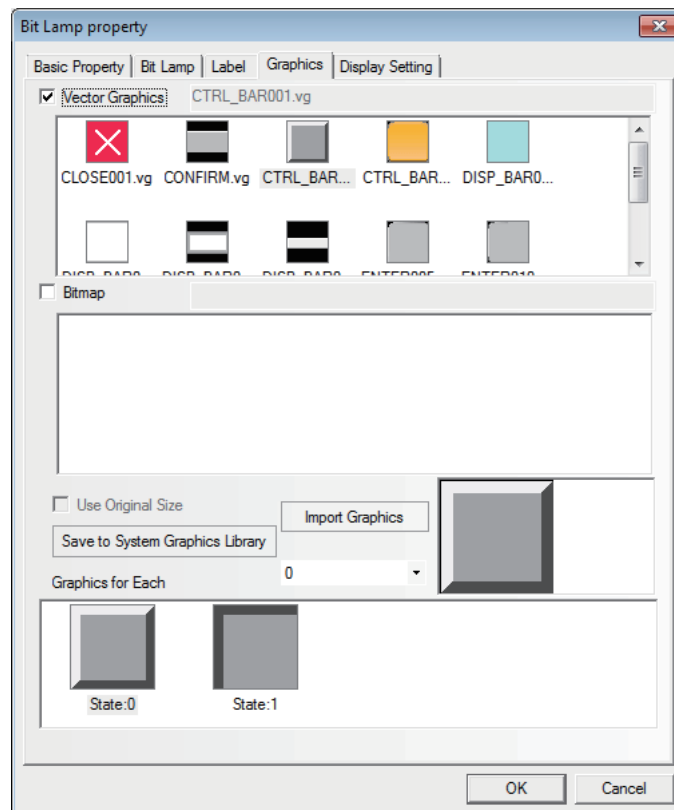

- 5** Switch to the [Display Setting] tab and adjust the position and size of the lamp component.

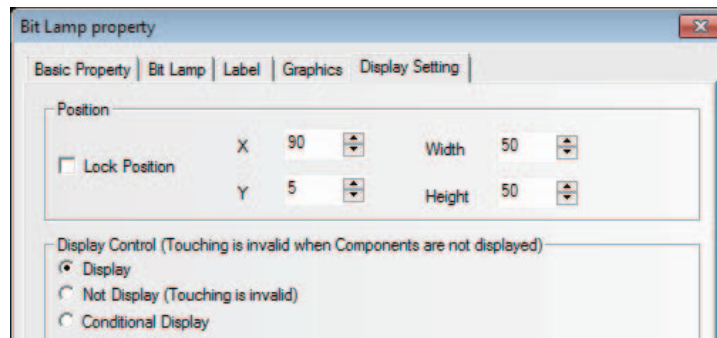

- 6** Press the [OK] button to complete the setup of the lamp component.

### 3-6-3 Bit Switch

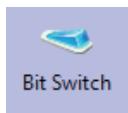

Bit Switch is the combination of the Bit Lamp and the Bit Button component. It defines a touching area, and the bit address inside the PT or of the PLC can be switched between On and Off state when this area is enabled.

#### ● Process of adding one Bit Switch

- 1** Drag the Bit Switch icon after it is pressed, then the [Basic Properties] dialog box of Bit Switch component will pop up.

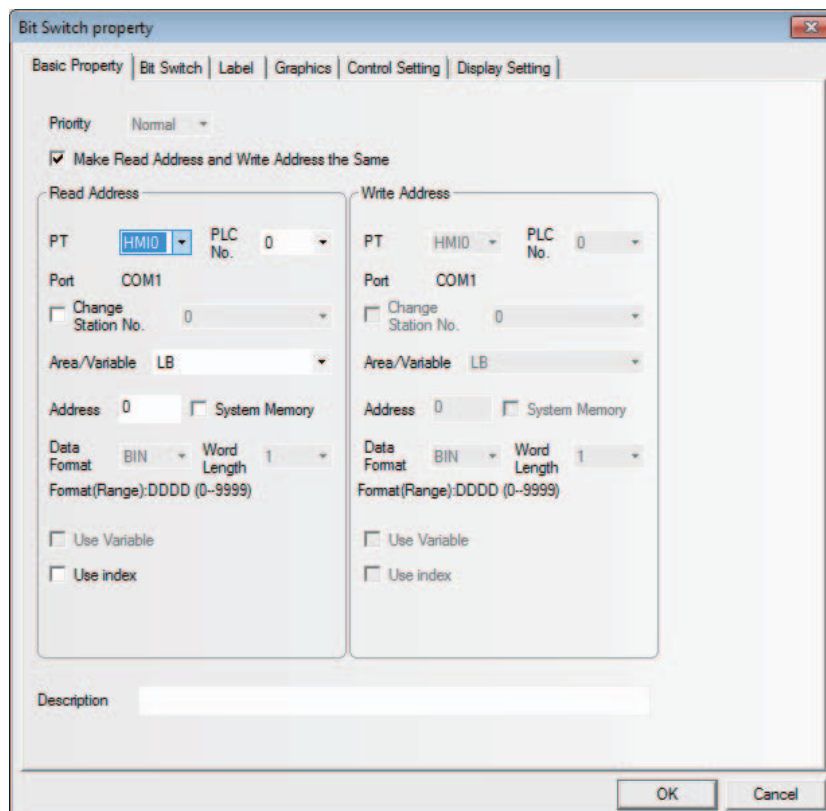

**Read Address:** Bit address controls the display information of Bit Switch such as the status, graphic, and label.

**Write Address:** Bit address writes the status of On or Off controlled by the Bit Switch.

**Address:** Refers to the Read/Write Address corresponding to the switch.

- 2** Switch to the [Bit Switch] tab and set switch type.

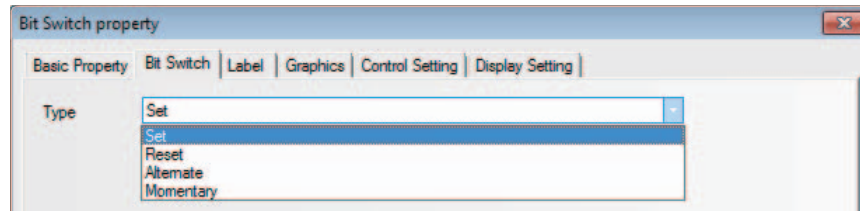

### Types and Functions of Switch

Type	Descriptions
Set	The specified bit address will turn On when the component is pressed. The state remains even if the component is released.
Reset	The specified bit address will turn Off when the component is pressed. The state remains even if the component is released.
Alternate	The state of the specified bit address will change once (On→Off→On) when the component is pressed each time.
Momentary	The specified bit address state will turn On or Off when the component is pressed or released respectively.

- 3** Switch to the [Label] and add the text corresponding to the state.
- 4** Switch to the [Graphics] tab, and select Vector Graphics or bitmap to display the bit address state and represent the touching area.
- 5** Switch to the [Control Setting] tab and make the Security Setting and set the Triggering action.
- 6** Press the [OK] button to complete the setup of the Bit Switch component.

## 3-6-4 Command Button

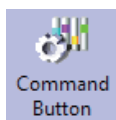

Command Button component also defines a touching area and the state value will be input into the specified word address when the area is enabled.

- **Process of adding one Command Button component**

- 1** Dragging the Command Button component icon after it is pressed will make the [Basic Properties] of Command Button component pop up.

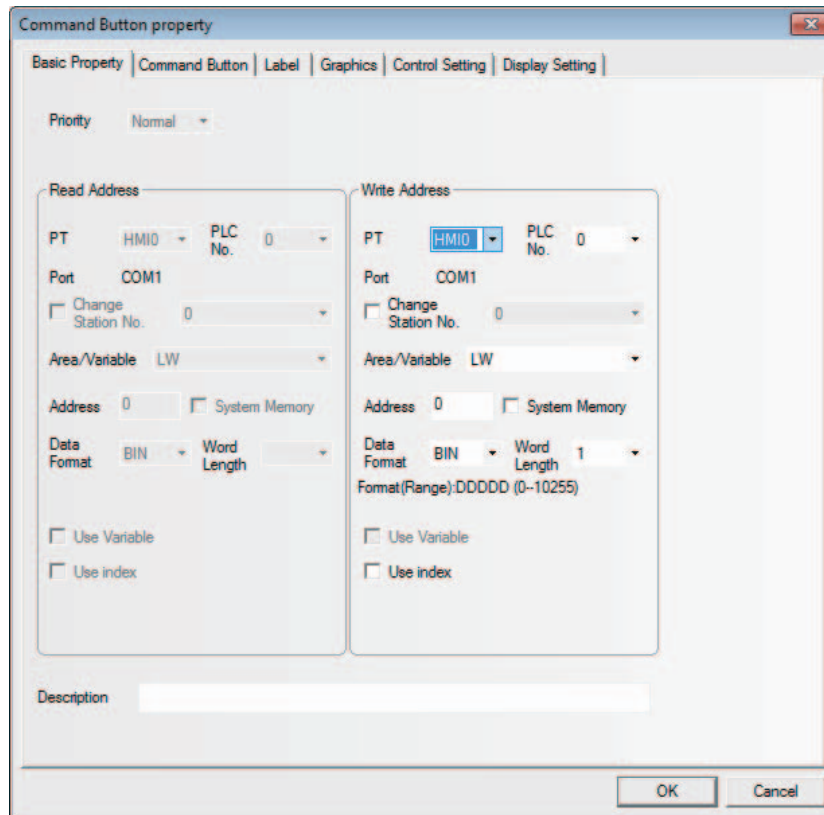

**Write Address:** Refers to the word address controlling the Command Button component.

**Address:** The first address of word address corresponding to the Command Button component.

**Word Length:** Set word length of the write address. Either of 1 (single word) or 2 (double words) can be specified.

- 2 Switch to the [Command Button] tab and set the “Type” for the Command Button component.

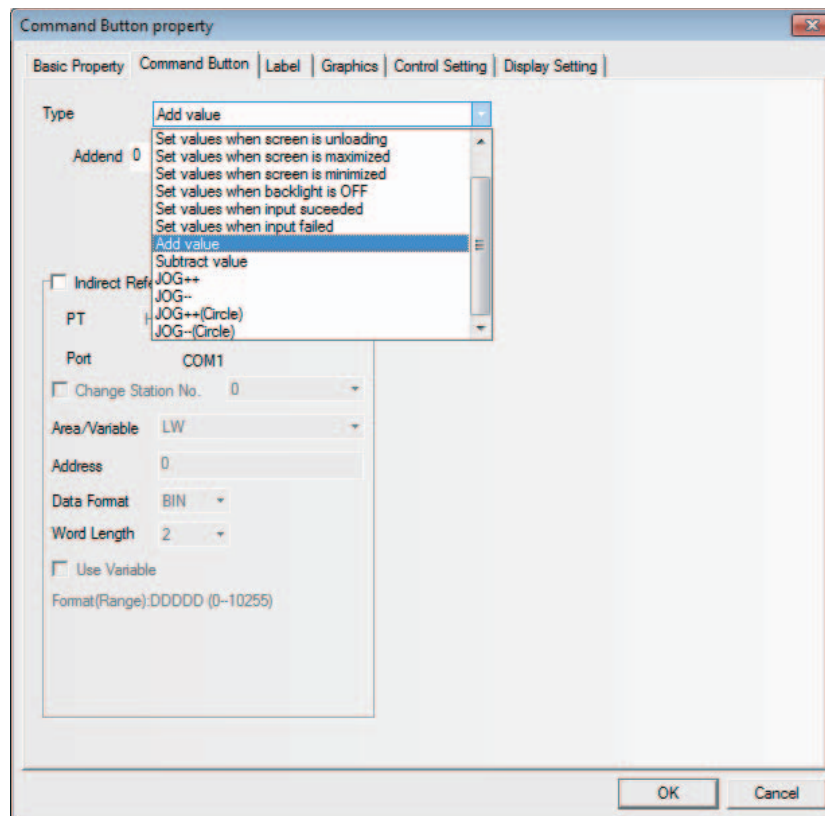

Setting Mode is as follows.

Type	Descriptions
Set Values	The preset constant will be written to the specified word address when this component is pressed. *
Set values when screen is loading	The preset constant will be written to the specified word address when one screen is opened. *
Set values when screen is unloading	The preset constant will be written to the specified word address when one screen is closed. *
Set values when screen is maximized	The preset constant will be written to the specified word address when the screen is maximized. *
Set values when screen is minimized	The preset constant will be written to the specified word address when the screen is minimized. *
Set values when backlight is OFF	The preset constant will be written to the specified word address when the backlight is Off. *
Set values when input succeeded	The preset constant will be written to the specified word address when the number or text is input successfully. (Input the constant to be set in “Set Value”.)*
Set values when input failed	The preset constant will be written to the specified word address when the number or text is not input successfully. *
Add value	Each time this component is pressed, the value of the specified word address will be increased by the “Addend” once, and its result will not exceed the “Upper”.*
Subtract value	Each time this component is pressed, the value of the specified word address will subtract the “Subtrahend” and its result will not be less than the “Upper”.*

Type	Descriptions
JOG++	Everytime command button is pressed for the time longer than the time to be specified "Delay Time", the value * set to "Addend" is added to the value of the write address with the interval set to "JOG Speed". The result will not exceed the "Upper". When [Ignore Delay Time] is checked, the "Addend" will be added to the value of the specified word address immediately each time the component is pressed. If this component is pressed for a long time, the "Addend" will be added to the value of the specified word address at the interval of "JOG Speed" time until the "Upper" is reached.
JOG--	Everytime command button is pressed for the time longer than the time to be specified "Delay Time", the value set to "Subtrahend" * is subtracted from the value of the write address with the interval set to "JOG Speed". The result will not be less than the "Lower". When [Ignore Delay Time] is checked, the "Subtrahend" will be added to the value of the specified word address immediately each time the component is pressed. If this component is pressed for a long time, the "Subtrahend" will be added to the value of the specified word address at the interval of "JOG Speed" time until the "Lower" is reached.
JOG++ (Circle)	Everytime command button is pressed for the time longer than the time to be specified "Delay Time", the value * set to "Addend" is added to the value of the write address with the interval set to "JOG Speed". Until the "Upper" is reached, and then it will increase from the "Lower" again.
JOG--(Circle)	Everytime command button is pressed for the time longer than the time to be specified "Delay Time", the value * set to "Subtrahend" is subtracted from the value of the write address with the interval set to "JOG Speed". Until the "Lower" is reached, and then it will decrease from the "Upper" again.

**\*Indirect Reference:** Refers to the variables that can be used by the setting or the upper/lower limit etc.

For example:

(a) When Setting Mode is "Set Value".

Assuming the write address of the Command Button component is LW0 with the "Type" of "Set Value", check [Indirect Reference] and select "LW10" as the address of variable parameter.

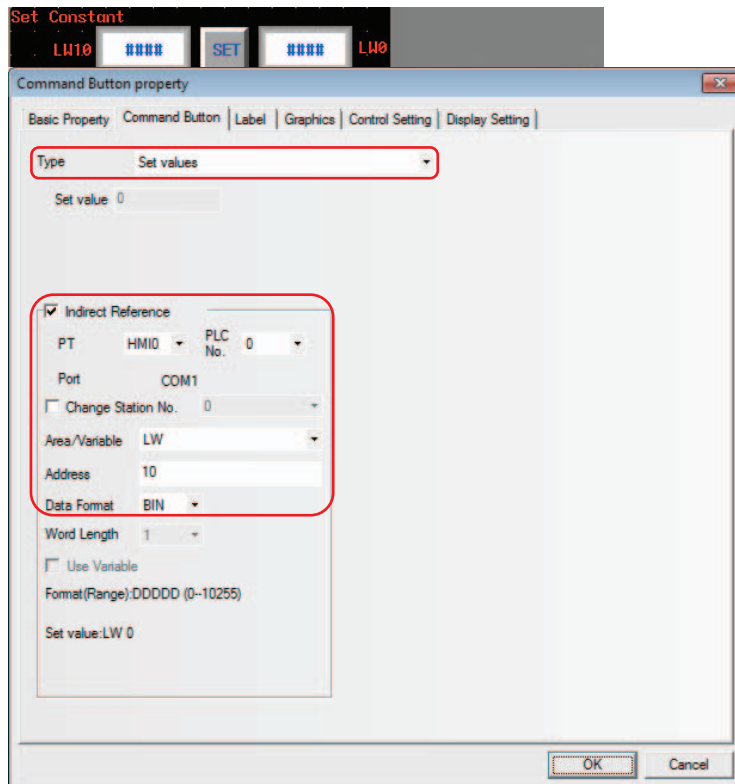



The settable indirect reference values are single-WORD BIN or BCD values. The value range varies depending on the selected data format.

BIN(unsigned)	0-65535
BIN(signed)	-32768 - 32767
BCD	0-9999

When LW10 is 5, it means the Set Value is 5. In this case, clicking “Set” will write the value of LW10 (i.e. 5) into LW0.

Perform the offline test and the effect is shown as below.



(b) When Setting Mode is “Add value”.

Assuming the write address of the Command Button component is LW5 with “Type” of “Add value”, check [Indirect Reference] and select “LW15” and “2” as the first address of variable parameter and the default word length respectively. The Addend address and the Upper Limit address are set by LW15 and LW16 respectively.

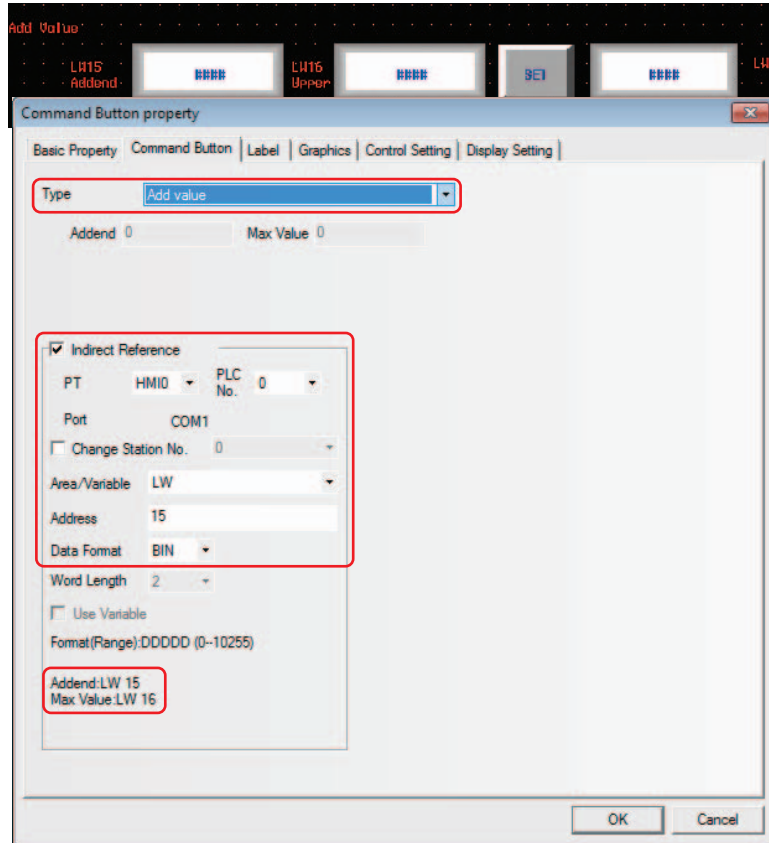

In addition, place 2 Number Input components with the addresses of LW15 and LW16 respectively as well as 1 Number Display component with the address of LW5.

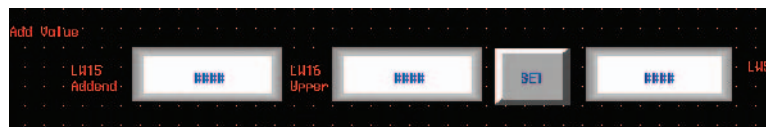

When LW15 is 10 and LW16 is 100, LW5 will increase by 10 each time when “Set” is pressed until the upper limit (i.e. 100) is reached and then stop increase.

Perform the offline test and the effect is shown as below.

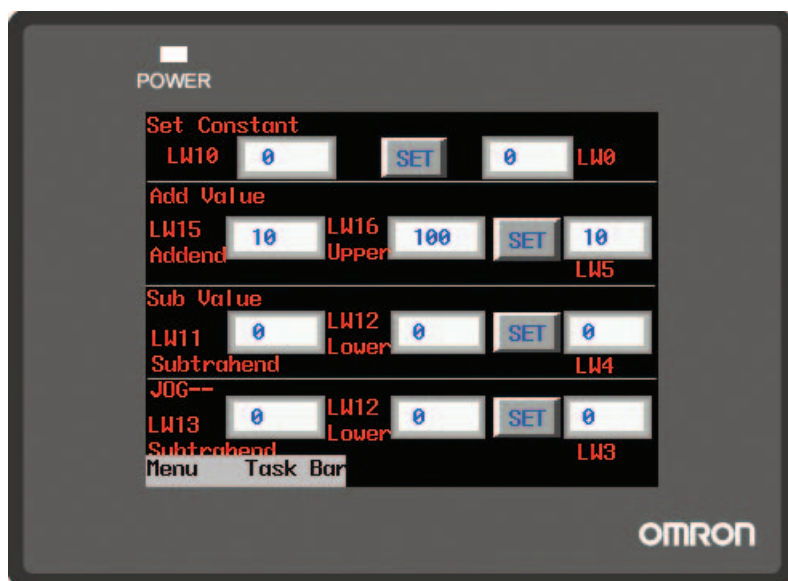

- 3** Switch to the [Label] tab and add the text describing the state.
- 4** Switch to the [Graphics] tab and select Vector Graphics or bitmap to display the bit address state and represent the touching area.
- 5** Switch to the [Control Setting] tab and make the Security Setting and set the Triggering action.
- 6** Press the [OK] button to complete the setup of the Command Button component.

### 3-6-5 Word Lamp



Word Lamp is the component which will switch the display information according to the value of the specified word address.

#### ● Process of adding one Word Lamp component

- 1 Drag the Word Lamp component icon after it is pressed will make the [Basic Properties] of Word Lamp component pop up.

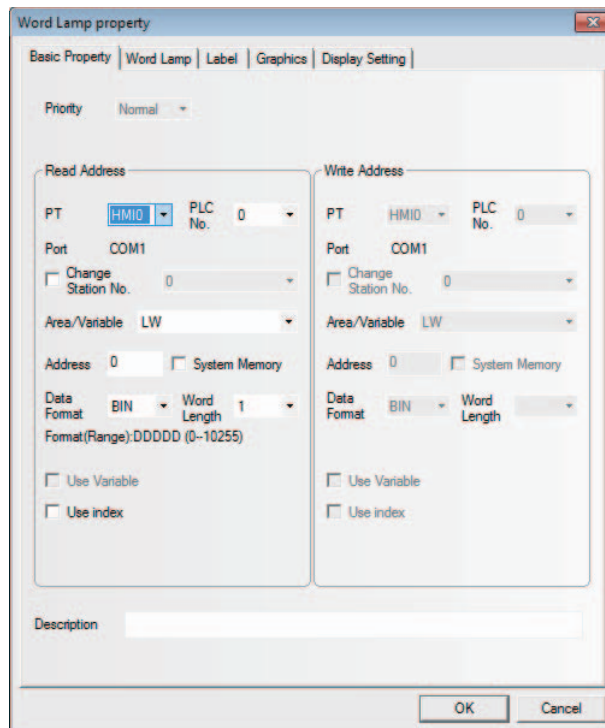

**Read Address:** Refers to the PLC address controlling the displayed information (such as the state, graphics, label and so on) of the Word Lamp component.

**Address:** The first address of word address corresponding to the Word Lamp component.

**Word Length:** Displays the data length of the Read Address, and 1 and 2 are available (i.e. word or double-word).

- 2 Switch to the [Word Lamp] tab and set the state for the Word Lamp component. You can set the state from 1 to 256 in the dropdown box corresponding to "State No.".

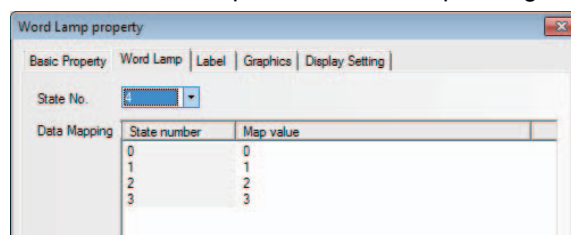

**Map Value:** Refers to the value corresponding to each state. When the value of read address is equal to the map value, the state number corresponding to this value will be displayed.

- 3** Switch to the [Label] tab and add the different displayed texts corresponding to the different states.
- 4** Switch to the [Graphics] tab and select Vector Graphics or bitmap to display the graphics corresponding to the state of the Word Lamp component.
- 5** Press the [OK] button to complete the setup of the Word Lamp component.

### 3-6-6 Word Switch



Word Switch is the component which changes the status value of the value specified for each status value and send the value to the specified address. The status value is changed by increasing or decreasing for each touch operation or by selecting from the list. When changing the status, the mapping value specified for each status will be sent to the specified memory. The statuses can be set up to 256.

● **Process of adding one Word Switch component**

- 1 Drag the Word Switch icon after it is pressed will make the [Basic Properties] of Word Switch component pop up.

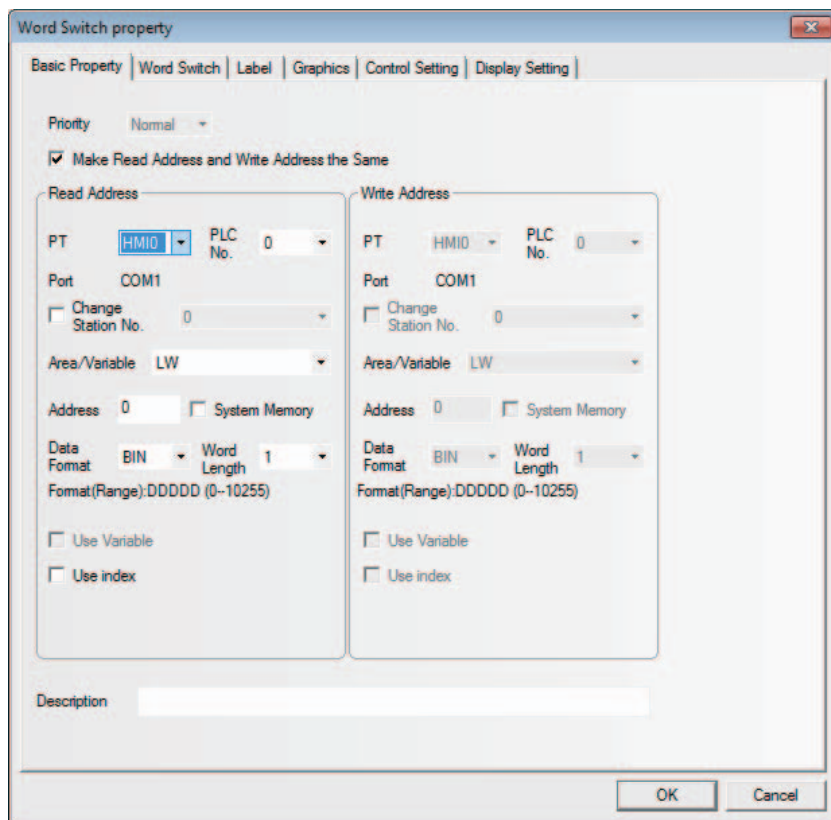

- 2 Switch to the [Word Switch] tab and set the State No. and the value corresponding to each state for the component. You can set the state from 1 to 256 in the dropdown box corresponding to "State No.".

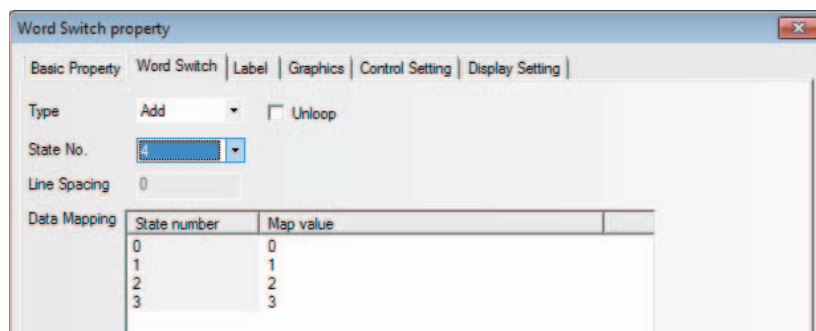

**Functions of Word Switch:**

Type	Descriptions
Add	<p>Each time this component is pressed, 1 will be added to the state number, and the map value of the corresponding state will be written into the specified write address, and the graphics corresponding to the state will be displayed according to the specified read address at the same time.</p> <p>Unloop: When it is checked, and the value of the memory for write address is equal to the value mapped by the set maximum state number, the component doesn't act when the switch is pressed again. When it isn't checked and the value of the memory of write address is equal to the value mapped by the set maximum state number, the value of the memory for write address is equal to the value mapped by the minimum state number.</p>
Sub	<p>Each time this component is pressed, 1 will be subtracted from the state number, and the map value of the corresponding state will be written into the specified write address, and the graphics corresponding to the state will be displayed according to the specified read address at the same time.</p> <p>Unloop: When it is checked, and the value of the memory for write address is equal to the value mapped by the minimum state number, the component doesn't act when the switch is pressed again. When it isn't checked and the value of the memory of write address is equal to the value mapped by the minimum state number, the value of the memory for write address is equal to the value mapped by the set maximum state number.</p>
List	All the set states will be displayed in the list form, and the current state is differentiated by the specified color.
Dropdown List	All the set states will be displayed in the dropdown list form, and the current state is differentiated by the specified color and the first information displayed in the dropdown list represents the current state.

For the control modes of Add and Sub, [Unloop] is not checked by default.

State No.: All 256 statuses can be set at maximum. (When BIN or BCD code and LSB code are used, or when LSB code is used, the status of 256 (at maximum) and the status of 17 (at maximum) will be displayed, respectively. Refer to *10 LSB Type (Page 3-377)* in the section 3-16 in *NB-Designer Operation*).

The line spacing for the list and the dropdown list can be set:

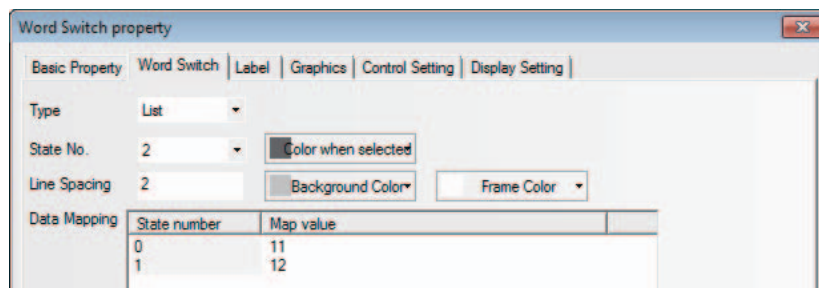

**Map Value:** When the value read by the read address is equal to a certain value in the Map Value, the Word Switch component will display the label and the graphics corresponding to the state number of this value. When a certain state number is switched to, the value corresponding to this value will be written into the write address.

- 3** Switch to the [Label] tab and add the text corresponding to the state.
- 4** Switch to [Graphics] tab, and select Vector Graphics or bitmap to display the memory state and represent the touching area.
- 5** Switch to the [Control Setting] tab and make the Security Setting and set the Triggering action.

**6** Press the [OK] button to complete the setup of the Word Switch component.

### ● List and Dropdown List

**List:** Refers to the value of the specified memory corresponding to the state of each option. By default, the value of specified memory corresponding to the first option is “0”, and the value of specified memory corresponding to the second option is “1”, and so on.

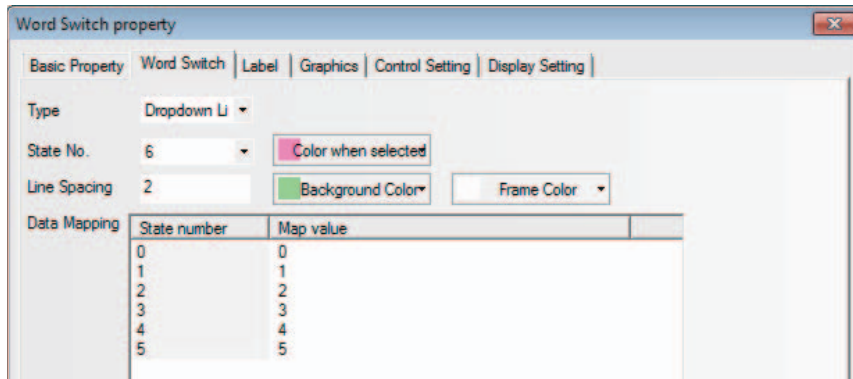

**For example:**

- (1) Create a Word Switch in which read address and write address are LW0 and a number display component in which address is LW0.
- (2) Set the Control Mode and State No. to “List” and “6” respectively.
- (3) Create the labels with the contents as shown below.

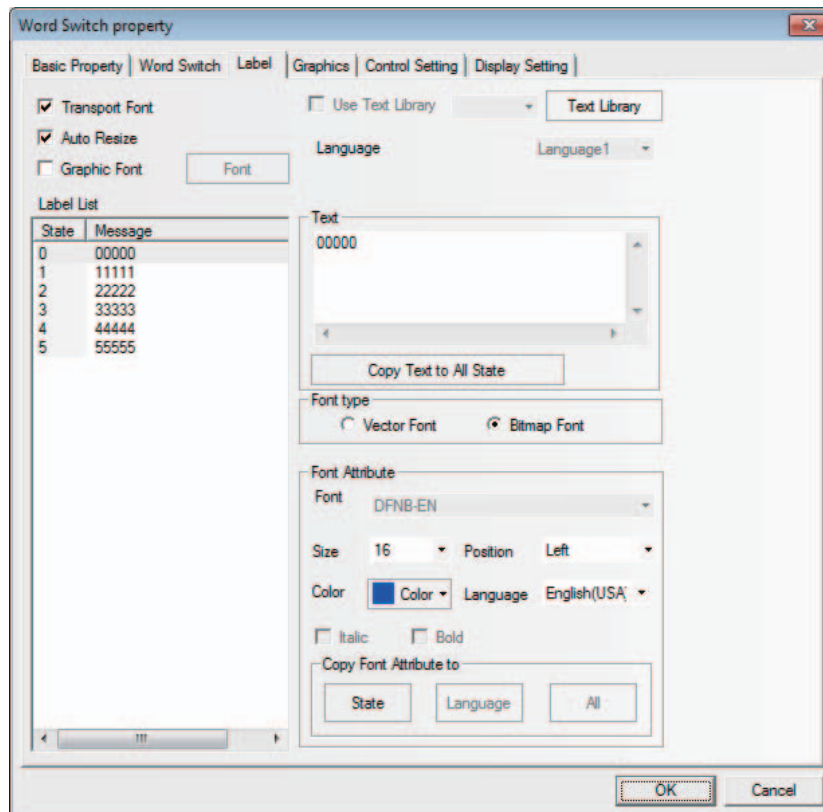



- (4) Perform the test and select “33333” in the list component, and “3” will be displayed in the State No.

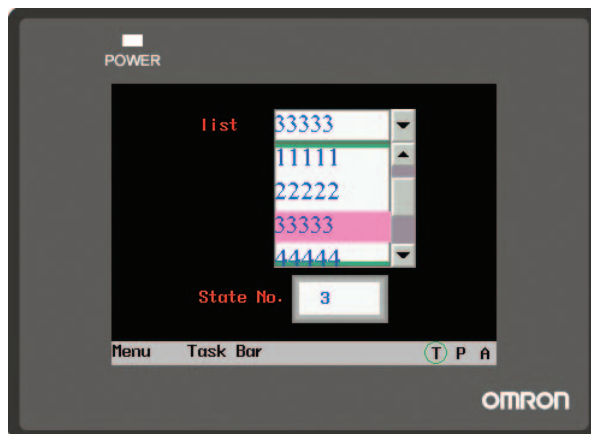

**Dropdown List:** When this component is touched, one list will pop up under this component. All the options are available in this list, and it will automatically disappear when one option is selected.

For example:

- (1) Create one Word Switch with read address and write address both of LW0 and one Number Display component with the address of LW0.
- (2) Set the Control Mode and State No. to “Dropdown List” and “6” respectively.
- (3) Set the label contents to “00000” to “55555”.
- (4) When performing the offline test and selecting the list, the status will be displayed with a list shown in the following figure on the right.

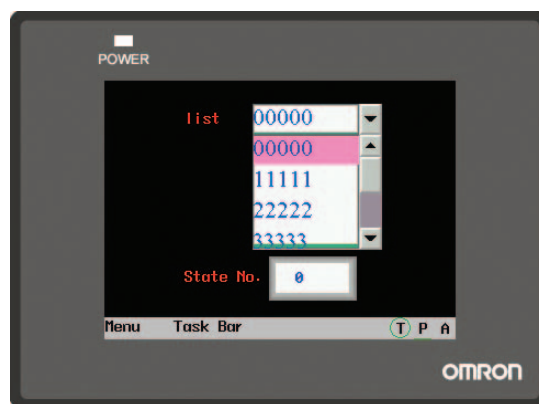
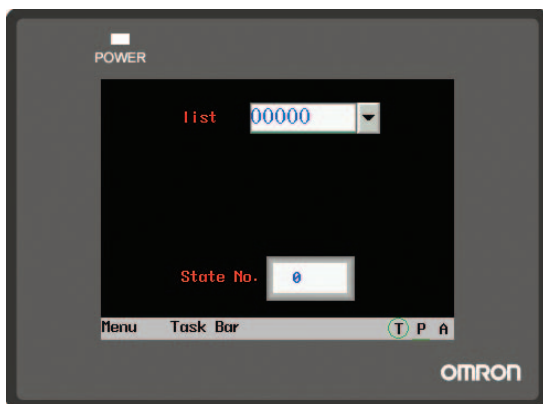

- (5) Touch this component, and the list option will pop up as the above right graphics shown.
- (6) After one option is selected, the list will disappear automatically.

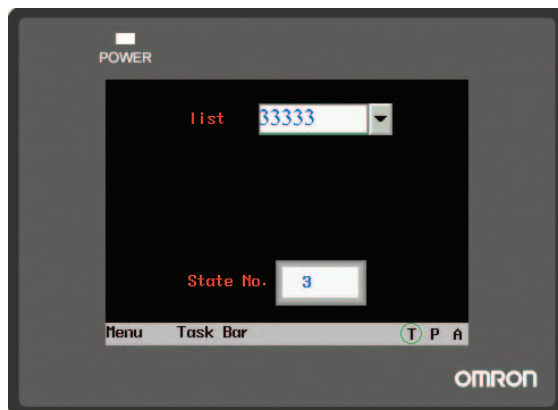

### 3-6-7 XY Graph

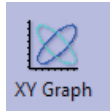

XY Graph reflects the correlation of two variables visually. If you want to monitor the XY Graph reflecting the changes of address values, the NB Unit can clearly displayed it out only by using this component.

When the sampling number with M channel per page is set to N, the values are stored to the PLC, e.g. X11, Y11, X12, Y12, ..., X1N, Y1N, ..., XM1, YM1, ..., XMN, YMN. The number of the memory addresses occupied by the PLC is  $M \times N \times 2$ .

**Note** For “X<sub>ij</sub>, Y<sub>ij</sub>”, subscript “i” represents the channel number, “j” represents the sampling point, and “X<sub>ij</sub>” represents the coordinate position of X for sampling point j in channel i.

#### ● Process of adding one XY Graph component

- 1 Press the XY Graph component icon, drag it to the screen, then the [Basic Properties] dialog box of XY Graph component will pop up.

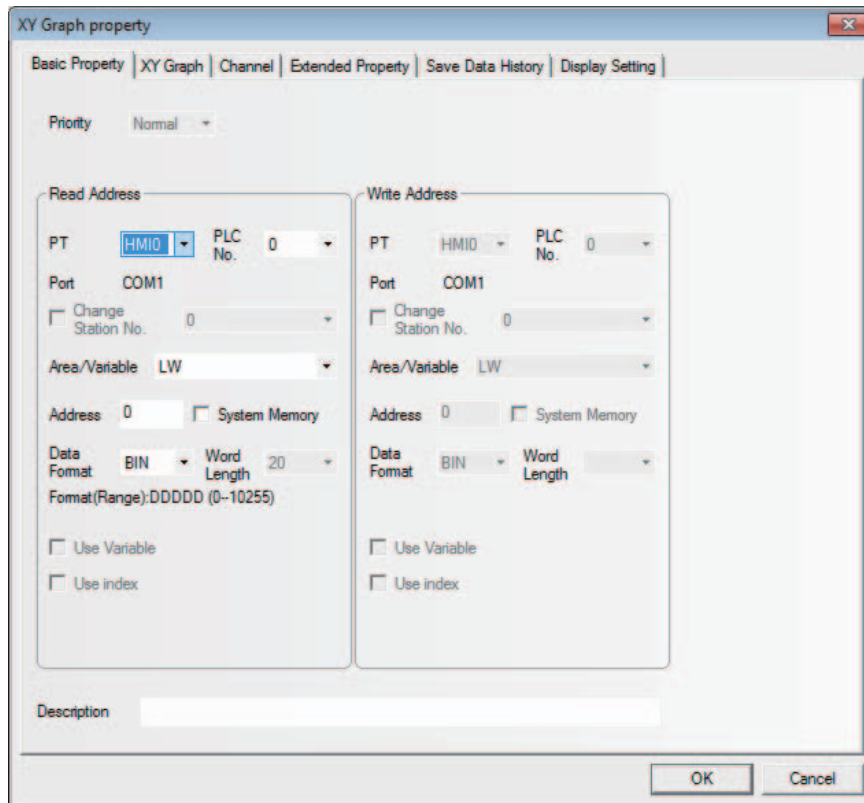

**Read Address:** Specifies the word address of PLC corresponding to the data of X-axis trajectory, and the word address corresponding to Y-axis is “read address + 1”. If the channel number is greater than 1, the addresses corresponding to the 2nd channel are as follows: “read address + 2 × sampling points” for X-axis and “read address + 2 × sampling point + 1” for Y-axis and so on.

**Address:** Refers to the first address of the word address corresponding to XY Graph.

**Data Format:** Includes BIN or BCD.

**Word Length:** It is determined by the channel number, sampling points, and the type of selected type of storing. The word length cannot be changed manually.

- 2 Go to the [XY Graph] tab and set the parameters related to the XY Graph.

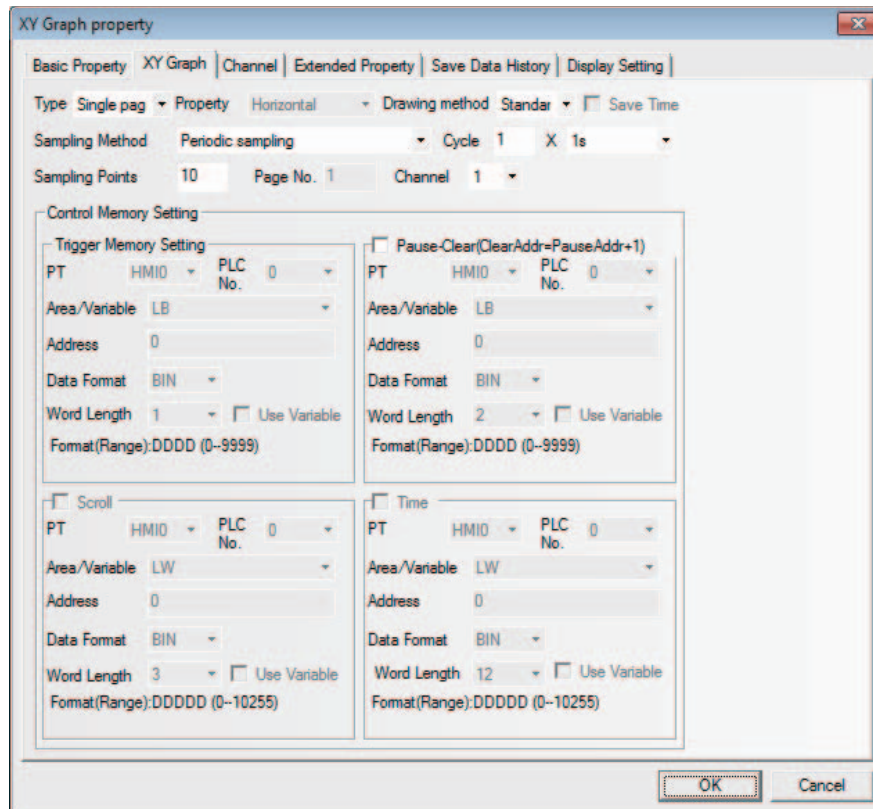

**Type:** Includes Single page and Multiple pages.

If “**Single page**” display is selected, only the data change information of the sampling value in the current page is displayed, and the points out of the sampling points in single page will not be saved and displayed. If “**Multiple pages**” display is selected, the old data can be displayed by scrolling and the data in the past can be saved. In this way, when the XY Graph is scrolled forward, the previous sampling data will not be lost. The history data is stored in the memory for the reference in future.

**Property (it is available option when [Trend] is selected for [Draw Type]:**

Refers to the horizontal direction and vertical direction, i.e. the graphics is displayed in horizontal direction or vertical direction when the sampling data is displayed.

**Sampling Methods:** They are shown as below.

Sampling Method	Descriptions
Periodic sampling	The data is sampled periodically.
OFF→ON trigger sampling	Only when the state of the specified bit address turns ON from OFF, the sampling is triggered.
ON→OFF trigger sampling	Only when the state of the specified bit address turns OFF from ON, the sampling is triggered.
OFF↔ON trigger sampling	Only when the state of the specified bit address changes, the sampling is triggered.
OFF→ON reset trigger sampling	Only the state of the specified bit address turns ON from OFF, the sampling is triggered, and the state of the specified bit address will be reset automatically after the triggering.
ON→OFF reset trigger sampling	Only the state of the specified bit address turns OFF from ON, the sampling is triggered, and the state of the specified bit address will be reset automatically after the triggering.

**Cycle:** Refers to the interval between the sampling points each 2 pages with the unit of “s” or “100 ms”.

**DrawType:** Includes Standard, Track and Trend. The sampling methods vary with the types.

Draw Type	Descriptions
Standard	Multiple points are sampled each time, and X and Y components are included. Number of the occupied memory depends on the number of channel and sampling points. For example, if there are m channels and n sampling points, number of the occupied memory is "m×n×2".
Track	One point is sampled each time, and X and Y components are included. Number of the occupied memory depends on the number of channel. For example, if there are m channels and n sampling points, the number of occupied memory is "m×2".
Trend	Multiple points are sample each time, and only Y component instead of X component is included. Number of the occupied memory depends on the number of channel and sampling points. For example, if there are m channels and n sampling points, number of the occupied memory is "m×n".

**Sampling Points:** Refers to the number of the sampling point displayed in the screen.

**PageNum:** When [Multiple pages] is selected in [Type], this option is valid. And it ranges from 1 to 32767.

**Channel:** Refers to the number of track line to be displayed, and it corresponds to the word length of read address to be set. And 2 word addresses correspond to one track line. The channel ranges from 1 to 16.

**Pause-Clear:** Set the bit address to control the pause of creating a line graph or the clear of creating a graph. [Clear] bit address = [Pause] bit address + 1. When [Clear] bit is ON, the sampling data will be cleared and when the bit turns OFF again, the sampling will continue and the changes in XY Graph will be displayed dynamically.

**Scroll:** The address specified by this bit is used in combination with the scroll components, i.e. the XY Graph can be viewed by directly moving the scroll bar. The scroll address should be set in consistent with the address used by the related scroll bar component. For details, refer to [3-6-22 Scroll Bar].

**Time:** When "Save Time" is checked, the below "Time" option can be selected. This option includes 12 words, and it is used to save the time for the latest sampling point currently. "Second, minute, hour, day, month, year" for the starting point and "Second, minute, hour, day, month, year" for the end point of the current page are stored in these 12 words respectively, and each word represent a point in time.

**3** Switch to the [Channel] tab and set the parameters related to each track line.

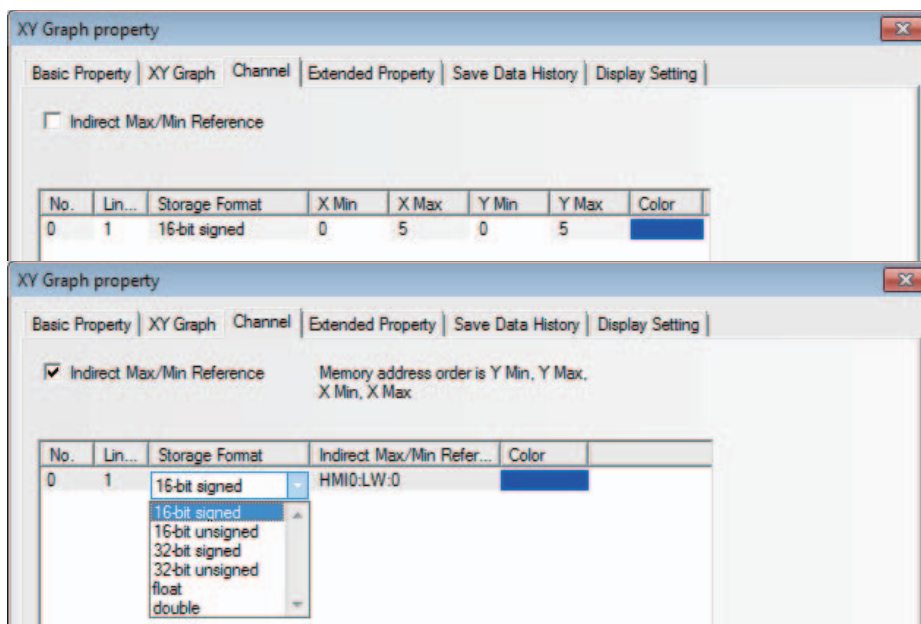

**Color:** Specifies the color for each track line.

**Line Width:** Refers to the thickness of the line, and 8 kinds of line width are available here.



**Storage Format:** Sets the data type used by the user and 6 kinds are available.

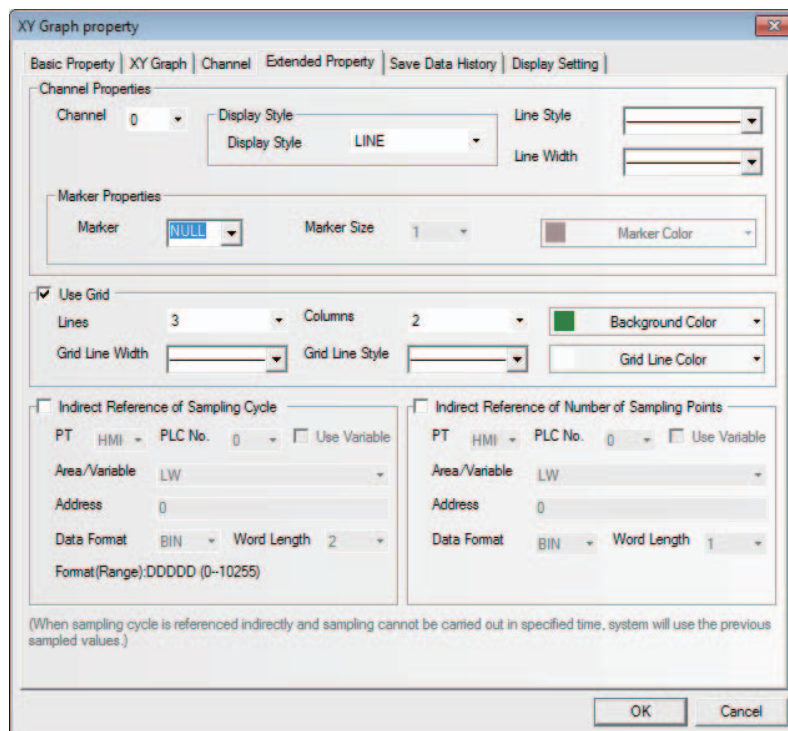

**Y Min/Y Max:** Sets the minimum value and maximum value of the data corresponding to each track line in Y direction. When the read value is greater than the maximum value or less than the minimum value, only the maximum value or minimum value will be displayed in the XY Graph.

**X Min/X Max:** Sets the minimum value and maximum value of the data corresponding to each track line in X direction. When the read value is greater than the maximum value or less than the minimum value, only the maximum value or minimum value will be displayed in the XY Graph.

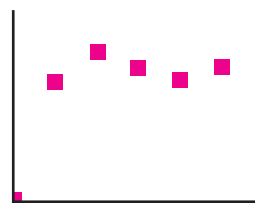
- 4** Switch to the [Extended Properties] tab and set Channel Properties, Grid Properties and Variable Period etc.

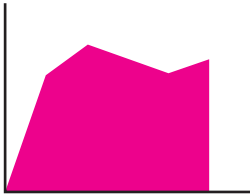

Extended Properties		Descriptions
Channel Properties		Select the channel to be edited. The optional channel depends on the channel number set in "Data Log" Property tab. And the set the Line Style and Line Width of track line corresponding to the channel.
Display Style	Dot	
	LINE	

Extended Properties	Descriptions	
Connect Type	X axis projection	
	Y axis projection	
Marker Properties	Select the Marker graphics from the 7 available graphics ●▲■○△□×.	
Marker Size	Sets the size of Marker.	
Marker Color	Sets the color of Marker.	
Use Grid	Checking this option means the Data Log will use the background and grid effect provided by the system, and the lines and columns of the grid to be displayed and the color, width and type of grid line, etc. can be set respectively.	
Indirect Reference of Sampling Cycle	When periodical sampling is used, the sampling time will be read from the specified memory.	
Indirect Reference of Number of Sampling Points	The sampling points will be read from the specified address.	

**5** Switch to the [Save Data History] tab and set information to be saved.

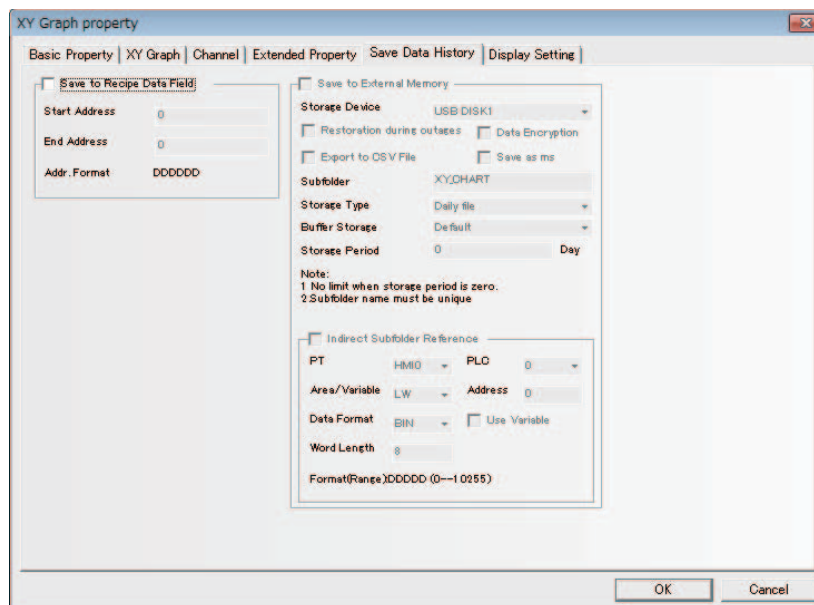

**Save to Recipe Data Field:** Checking this option means the data will be saved into the address of memory for recipe memory in the PT (i.e. RW memory).

The area used for storing data can be calculated with those formulas as follows.

- Standard or Track:  $20 + \text{Sampled pages} \times 4 + \text{Sampled pages} \times \text{Sampled points} \times \text{Number of Channels} \times 2$
- Trend:  $20 + \text{Sample pages} \times \text{Sampled points} \times 4 + \text{Sampled pages} \times \text{Sampled points} \times \text{Number of Channels}$

**6** Press the [OK] button to complete the setup of the XY Graph component.

Example: When the maximum value and minimum value of a line graph (Drawing method: Standard) are specified indirectly.

Descriptions: The coordinate position of sampling point 1 and sampling point 2 correspond to “x, y (LW10, LW11)” and “x, y (LW12, LW13)”; and the minimum values and maximum values of y coordinate and x coordinate are LW20 & LW21 and LW22 & LW23 respectively.

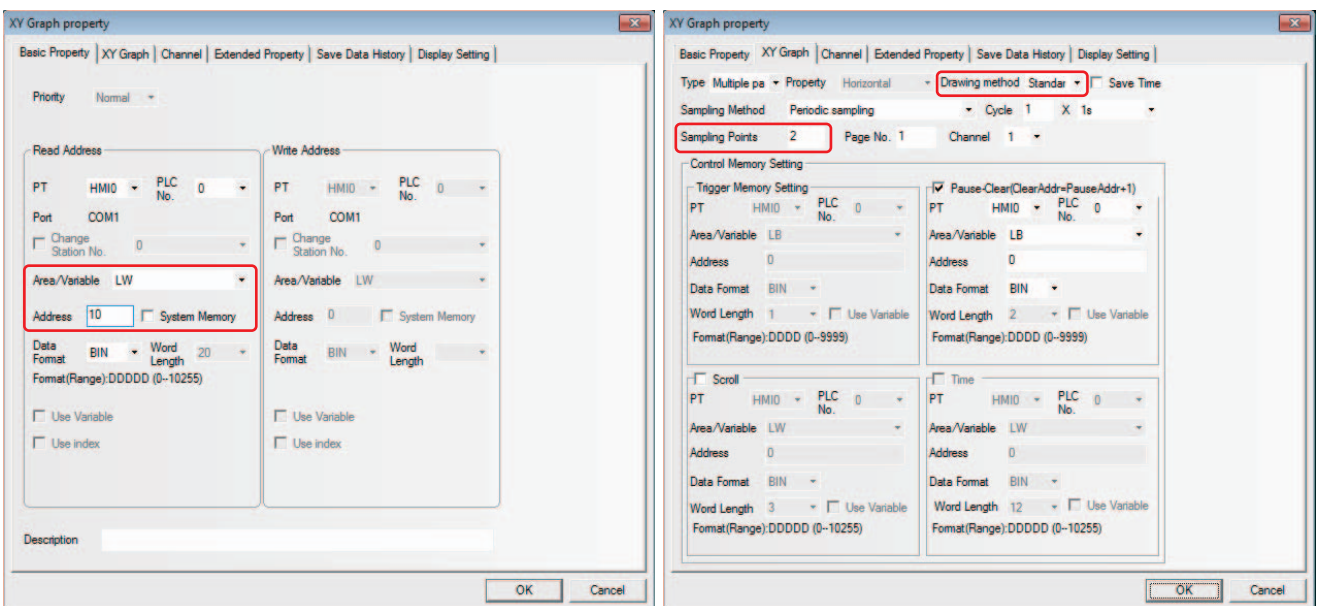
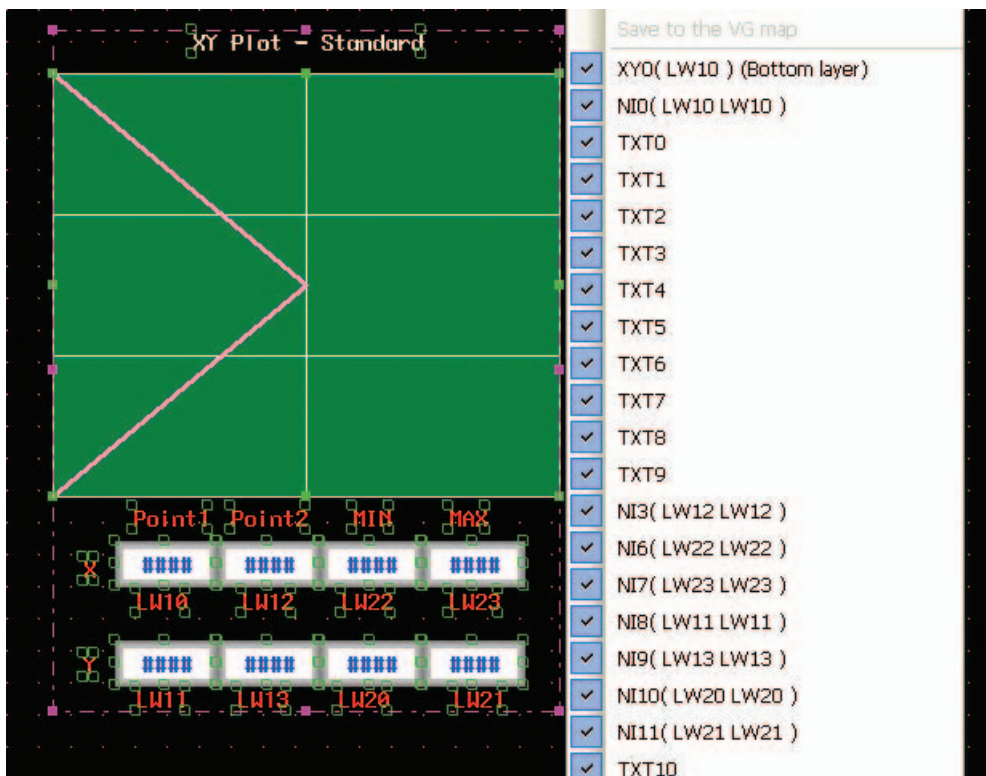

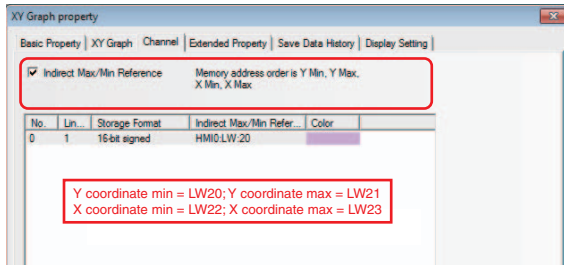

Example: When the maximum value and minimum value of a line graph (Drawing method: Track) are specified indirectly.

Descriptions: The position coordinate is allocated as below.

There is only 1 sampling point whose coordinate value corresponds to “x, y” (LW10, LW11), and the minimum values and maximum values for y coordinate and x coordinate are “LW20 & LW21” and “LW22, LW23” respectively.

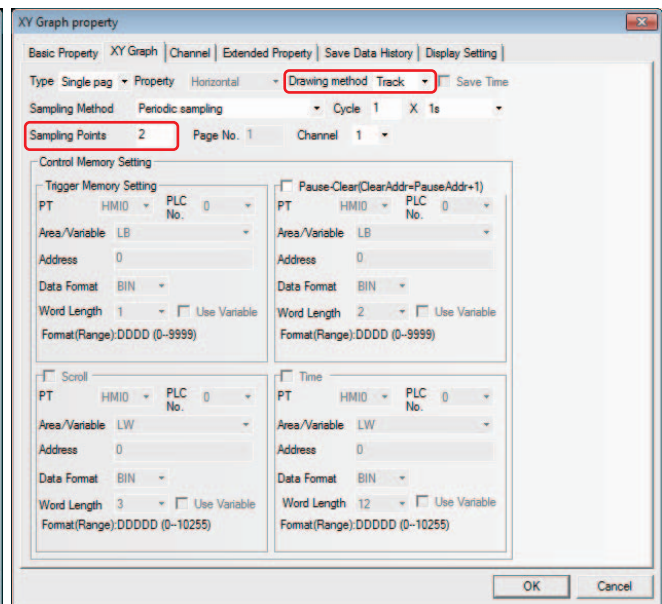
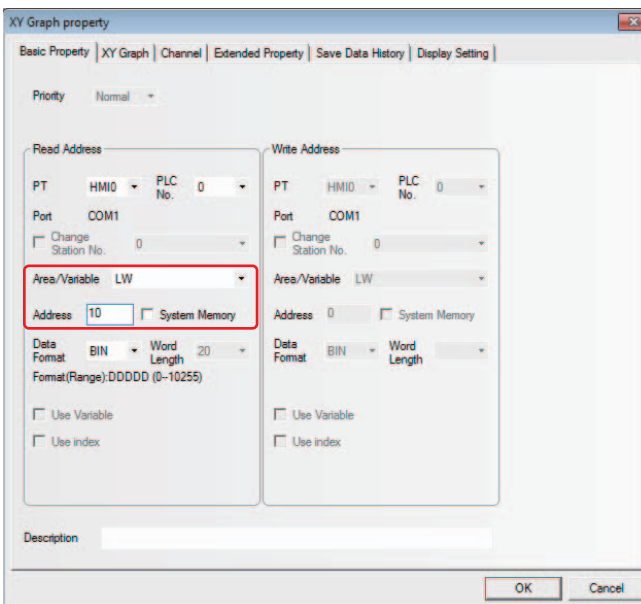
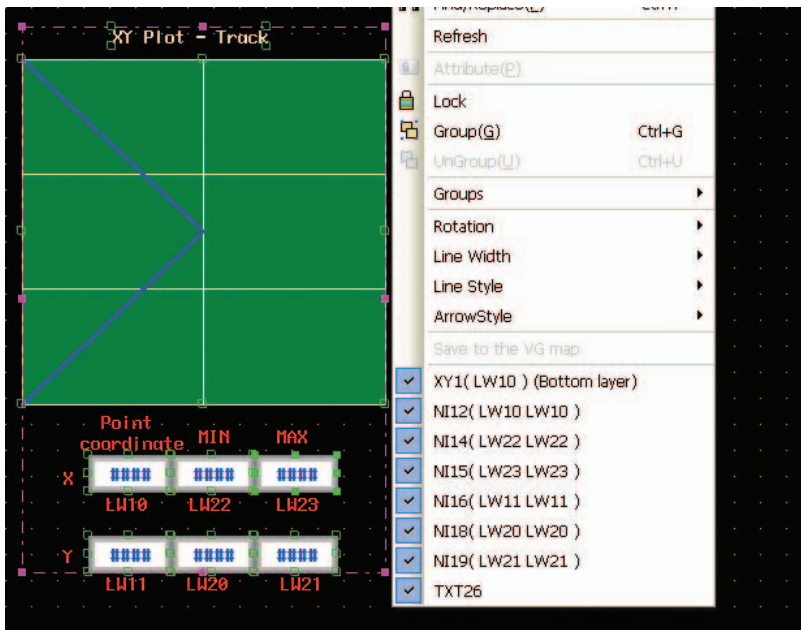



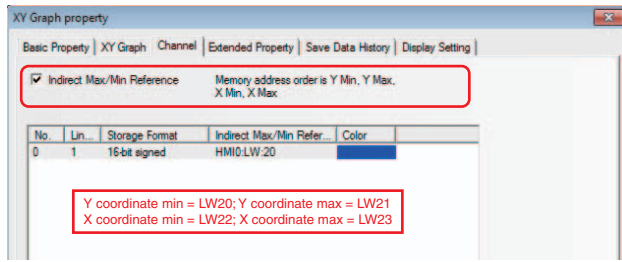

Example: When the maximum value and the minimum value of a line graph (Drawing method: Trend) are specified indirectly.

Descriptions: The position coordinate is allocated as below:  
 There are 2 sampling points corresponding to y1 (LW10) and y2 (LW11), and LW20 and LW21 correspond to the minimum (lower limit of Y) and the maximum value (upper limit of Y) respectively.

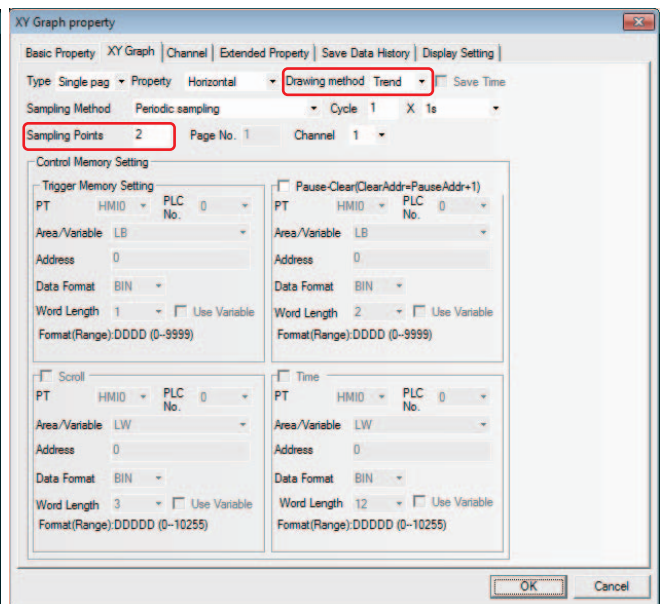
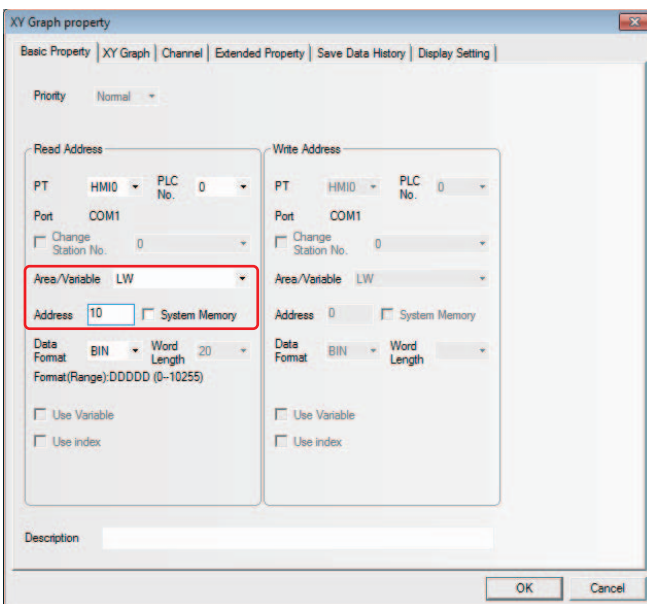
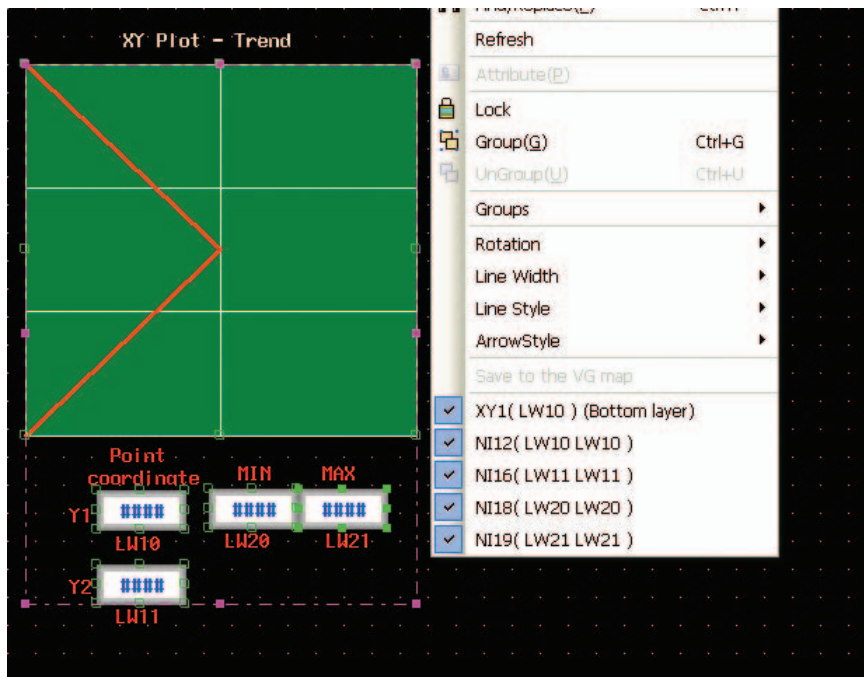

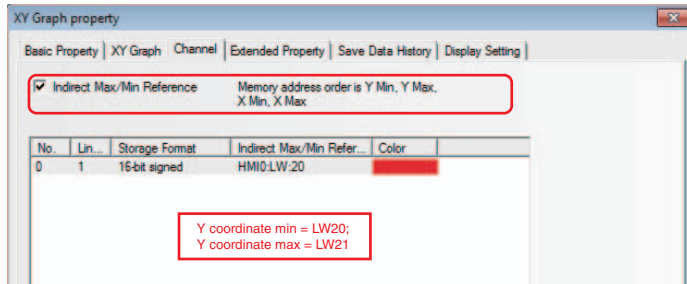

Perform the test and the effect is as shown below.

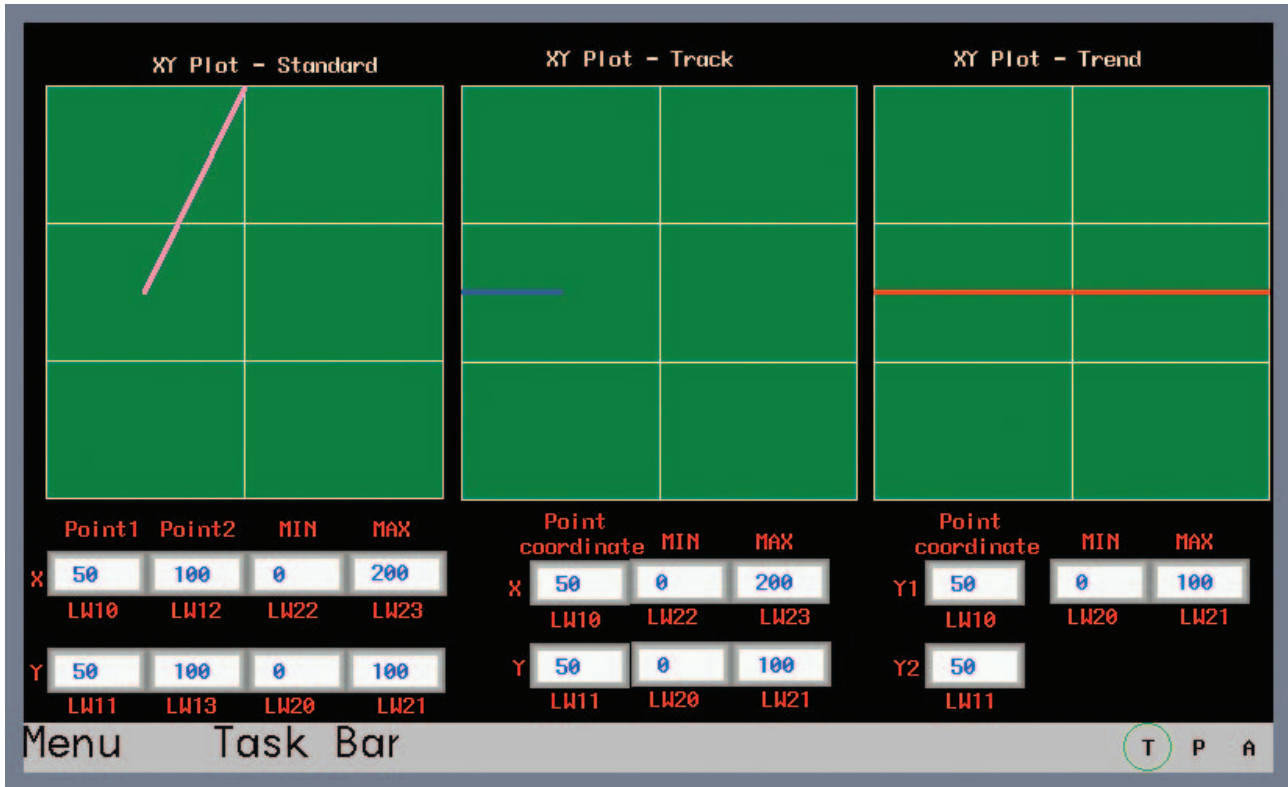

### 3-6-8 Moving Component



Moving Component can be used to put one Vector Graphics or bitmap into the position specified by PLC in the PT. The state and absolute position are provided by the 3 consecutive memories in PLC. The read address controls the status of the component, the address of the Read Address + 1 controls the coordinate position X, and the address of the Read Address + 2 controls the coordinate position Y.

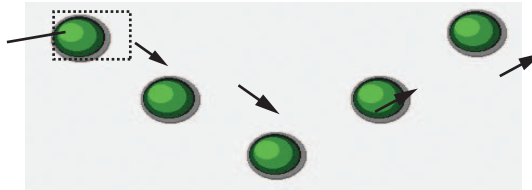

#### ● Process of adding one Moving Component

- 1 Press the Moving Component icon, drag it to the screen, then the [Basic Properties] dialog box of the Moving Component will pop up.

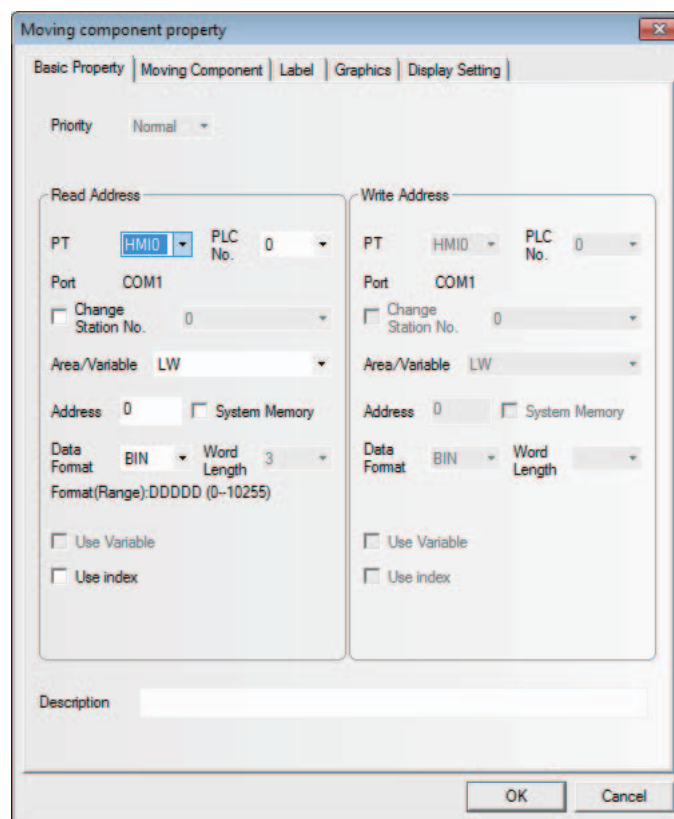

**Read Address:** Controls the first address of the word address controlling the displayed information (such as the state, graphics, label and so on) of the Moving Component in PLC.

**Address:** Refers to the first address of the word address corresponding to the Moving Component.

**Word Length:** Displays the data length of the read address, which is fixed to "3".

- 2** Switch to the [Moving Component] tab and set the Type, State Number, the Minimum of X, Maximum of X, Minimum of Y and Maximum of Y.

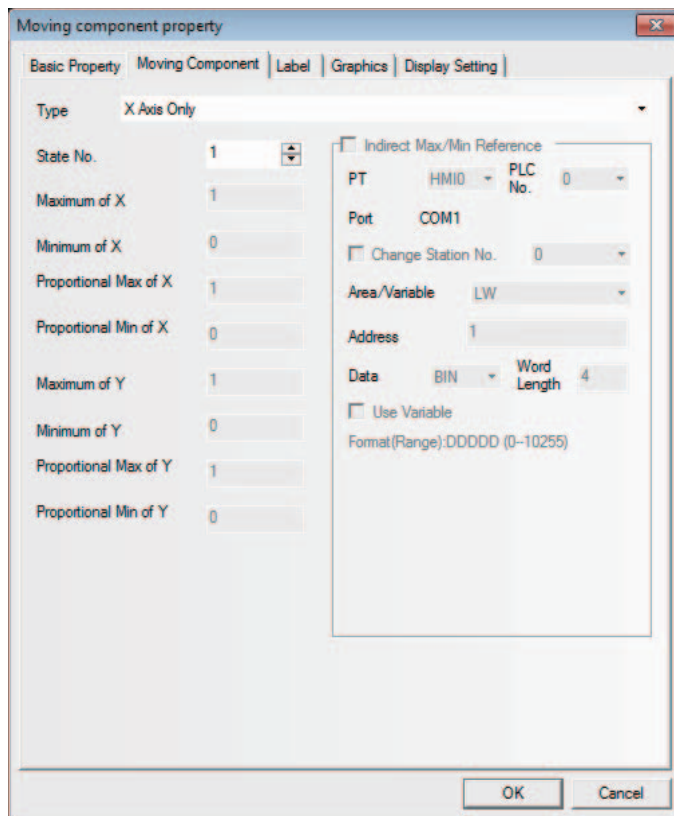

**Type and Function Tables:**

NB-Designer can assign up to 256 kinds of different states to the components. When State Number is set to "1" in the tab [Moving Component], make sure that the stored value specified to the [Read Address] is 0. Otherwise, the components will not be displayed, States 1 to 256 correspond to the internal values of 0 to 255. The position control is as shown below, and its position is relative to the original position (X-axis and Y-axis represent abscissa and ordinate respectively.)

Control Mode	X	Y	X & Y
Number of Read Address	2 words	2 words	3 words
Read Address	States of Vector Graphics or bitmap	States of Vector Graphics or bitmap	States of Vector Graphics or bitmap
Read Address + 1	X-axis displacement	Y-axis displacement	X-axis displacement
Read Address + 2	-	-	Y-axis displacement

The Type includes the items as follows.

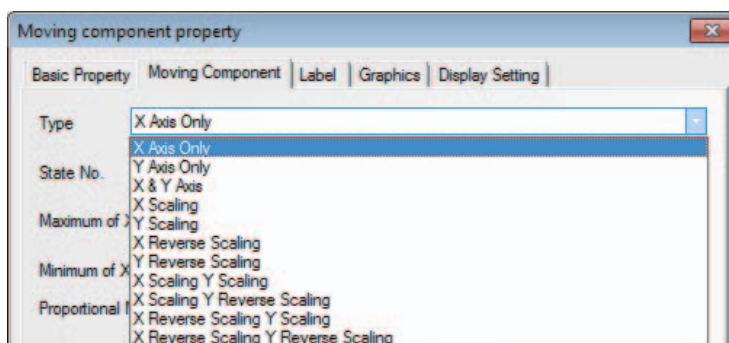

The descriptions of the Type are as follows.

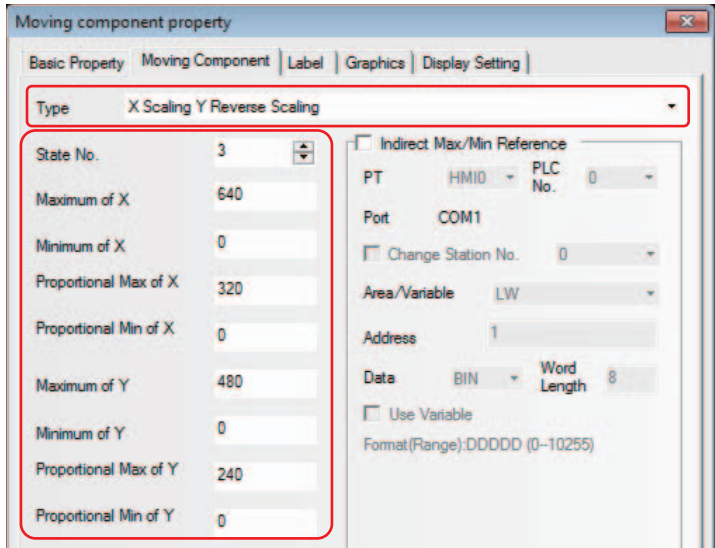
X Axis Only	When this option is selected, the Moving Component can only move horizontally along X-axis and the input maximum (minimum ) value is invalid and the Read Address and the Read Address + 1 are used to store the component state and position respectively in this case.
Y Axis Only	When this option is selected, the Moving Component can only move vertically along Y-axis and the input maximum (minimum ) value is invalid and the Read Address and the Read Address + 1 are used to store the component state and position respectively in this case.
X & Y Axis	When this option is selected, the Moving Component can move along X-axis and Y-axis, and the Read Address, the Read Address + 1 and the Read Address + 2 are used to store the component state, X-axis position and Y-axis position respectively.
X Scaling	When this option is selected, the Moving Component can only move horizontally along X-axis, but the relative moving position can be set through the input value and proportional value (For example, when the value of PLC to be read ranges from 0 to 1000, but the relative position to be moved in the PT ranges from 0 to 640, the minimum values and maximum values of proportion value and input value are 0 & 640 and 0&1000 respectively.) and the Read Address and the Read Address + 1 can be used to store the component state and the position respectively.
Y Scaling	When this option is selected, the Moving Component can only move vertically along Y-axis, but the relative moving position can be set through the input value and proportional value (For example, when the value of PLC to be read ranges from 0 to 1000, but the relative position to be moved in the PT ranges from 0 to 480, the minimum values and maximum values of proportion value and input value are 0 & 480 and 0&1000 respectively.) and the Read Address and the Read Address + 1 can be used to store the component state and the position respectively.
X Reverse Scaling	This option functions are similar with “X Scaling” but the component moves toward the opposite direction. When the value of position coordinate increases, the component moves leftward. When it decreases, the component move rightward.
Y Reverse Scaling	This option functions are similar with “Y Scaling” but the component moves toward the opposite direction. When the value of position coordinate increases, the component moves upward. When it decreases, the component move downward.
X Scaling Y Scaling	The Moving Component moves horizontally along X-axis and Y-axis, and the relative position can be set through the input value and the proportion value (For example, set the parameters as below. When the stored PLC address specified to X axis ranges from 0 to 640, but should set the value to be moved relatively in the range from 0 to 320 and the stored PLC address specified to Y axis ranged from 0 to 480, but should set the value to be moved relatively in the range from 0 to 240.). 
X Scaling Y Reverse Scaling	The Moving Component moves horizontally along X-axis and Y-axis, and the relative position to be moved can be set, and the component can move along the opposite direction of Y-axis. When the value of Y-axis is increased, the moving component moves upward, and when the value of Y-axis is decreased, it moves downward.
X Reverse Scaling Y Scaling	The Moving Component moves horizontally along X-axis and Y-axis, and the relative position to be moved can be set, and the component can move along the opposite direction of X-axis. When the value of X-axis is increased, the Moving Component moves leftward and when the value of X-axis in decreased, it moves rightward.

X Reverse Scaling Y Reverse Scaling	The Moving Component moves horizontally along X-axis and Y-axis, and the relative position to be moved can be set, and the component can move along the opposite directions of X-axis and Y-axis. When the value of X-axis is increased, the Moving Component moves leftward, and when the value is decreased, it moves rightward. When the value of Y-axis is increased, it moves upward and when the value is decreased, it moves downward.
--	---

When the Scaling is selected, the relation is as shown below.

$$\text{Display Position} = \text{Current Position} + \frac{(\text{Read Value} - \text{Minimum Input Value}) \times (\text{Maximum Proportional Value} - \text{Minimum Proportional Value})}{(\text{Maximum Input Value} - \text{Minimum Input Value})}$$

When the reverse scaling is selected, the relation is as shown below.

$$\text{Display Position} = \text{Current Position} + \frac{(\text{Minimum Input Value} - \text{Read Value}) \times (\text{Maximum Proportional Value} - \text{Minimum Proportional Value})}{(\text{Maximum Input Value} - \text{Minimum Input Value})}$$

**Indirect Max/Min Reference:** The upper limits and lower limits of X-axis and Y-axis are directly read from the memory address.

For example:

It is assumed that the type of the Moving Component is “X Reverse Scaling Y Reverse Scaling” and the type of indirect address is LW10, then the Minimum of X and Maximum of X are the values of LW10 and LW11 respectively, and Proportional Lower Limit of X and Proportional Upper Limit of X are the values of LW12 and LW13 respectively, and the Minimum of Y and Maximum of Y are the values of LW14 and LW15 respectively, and the Proportional Lower Limit of Y and Proportional Upper Limit of Y are the values of LW16 and LW17 respectively. as shown below.

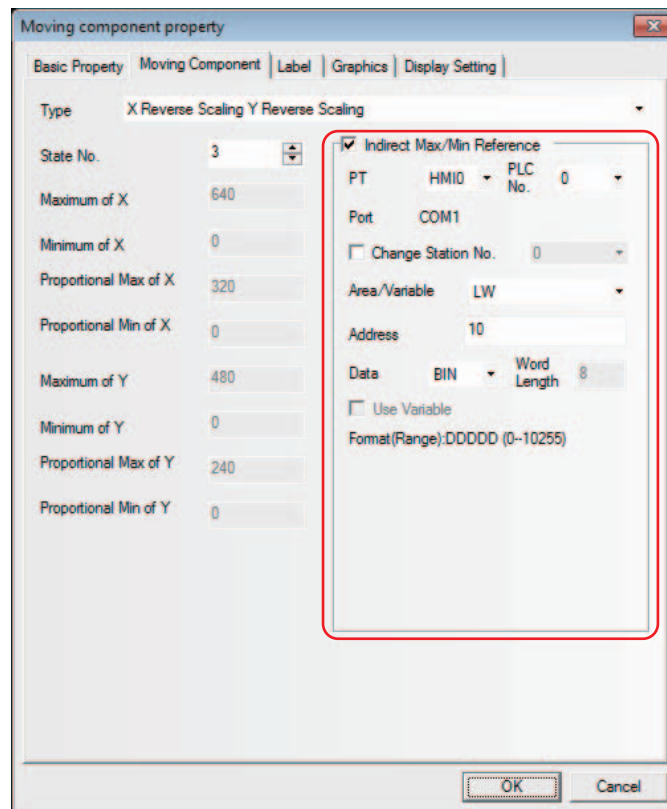

- 3 Switch to the [label] tab and add the corresponding texts to be displayed.

**4** Switch to the [Graphics] tab and select Vector Graphics or bitmap to move or display the state.

**5** Press the [OK] button to complete the setup of the Moving Component.

If it is Scaling Type, specify the Max/Min value.

The maximum value and minimum value of Moving Component supports Indirect Max/Min Reference.

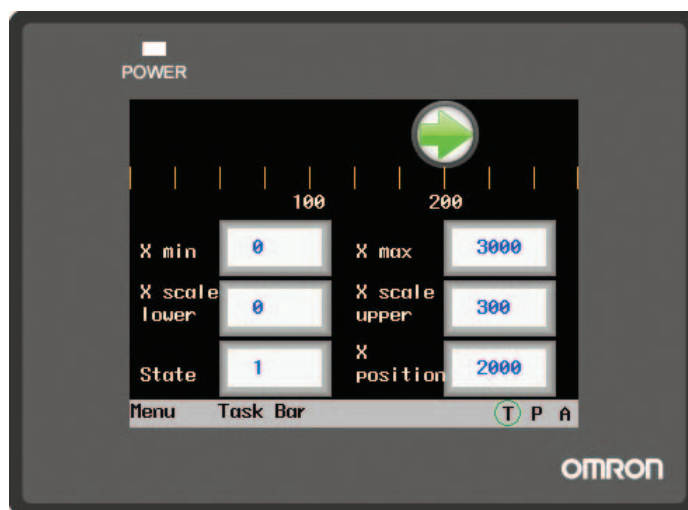
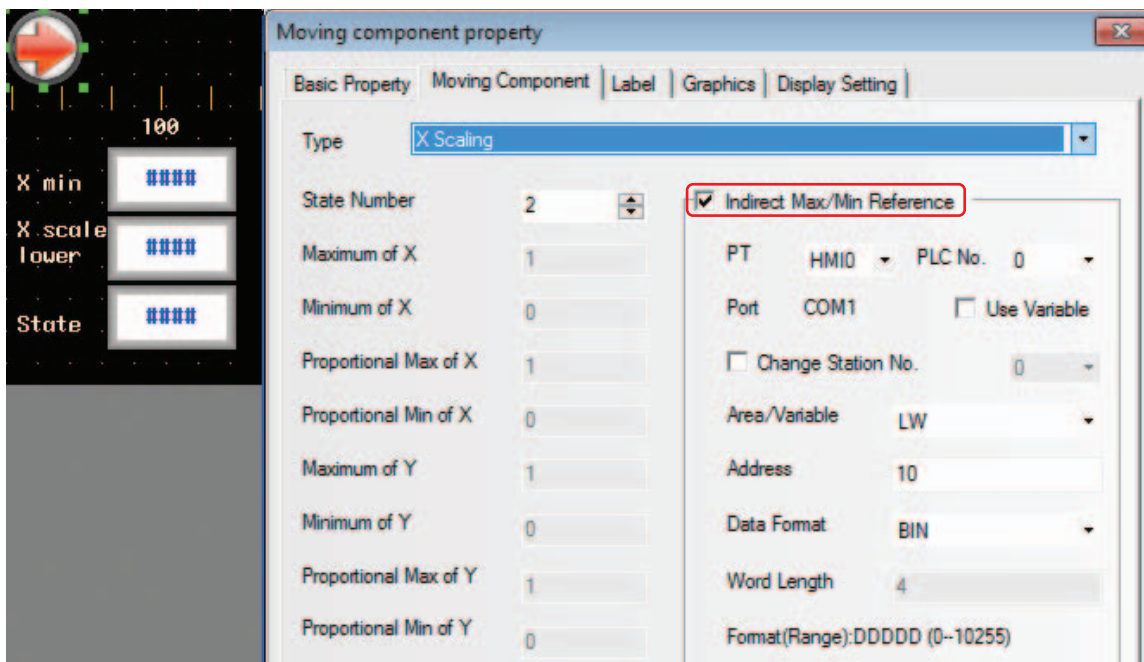

### 3-6-9 Animation



The Animation component is used to put the component into the position with the specified track in the PT, and this position is determined by the preset path and the data of PLC. The status and absolute position of the component in the PT is determined by the data in the 2 consecutive PLC memories. Generally speaking, the Read Address and the Read Address + 1 are used to store the state and the position in the preset path respectively. When the values in the position memory of PLC (Read Address + 1) change, the Vector Graphics or bitmap will jump to the next position in the preset path.

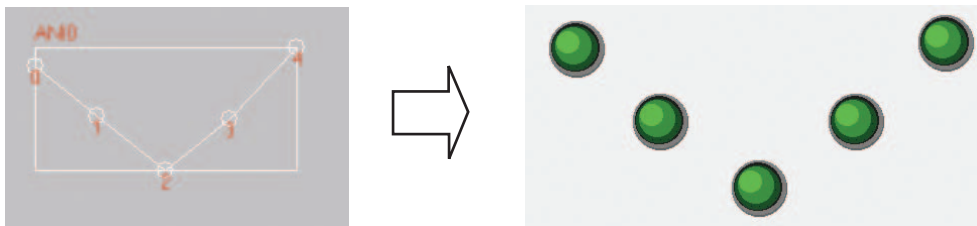

#### ● Process of adding one Animation component

- 1** Click the Animation component icon and drag it on the screen.
- 2** Set the path and moving point for the component in the PT, left click the mouse one by one on each moving node, and right-click the mouse after the setup of path and moving nodes to complete the setup.
- 3** Enter the parameters in [Basic Properties] tab in the [Animation Property] dialog box.

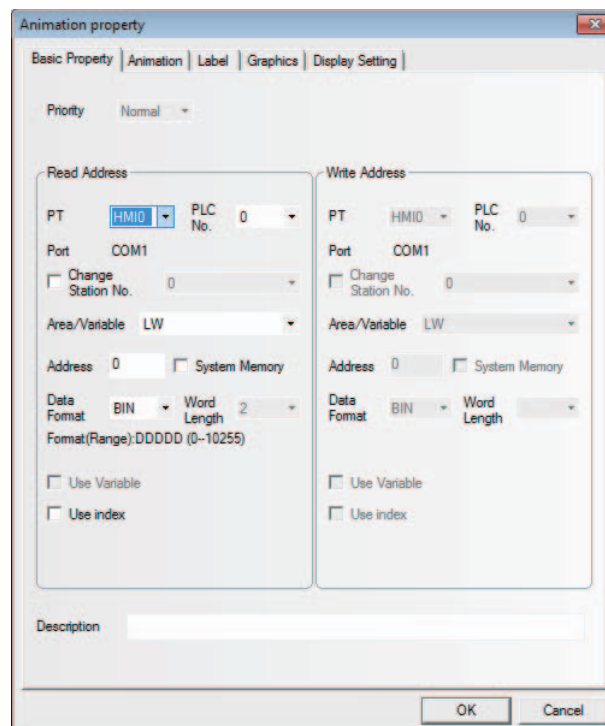

**Read Address:** Refers to the word address controlling the state and label of the Animation Component in PLC, and [Read Address + 1] refers to the word address controlling the position of the Animation component. The data in the memory will be converted into BIN or BCD format (Refer to the Word Lamp component.). Here, [Word Length] is limited to 2.



**Read Address Assignment:**The word address specifying the position on the path which was set previously is set automatically to Read Address + 1.

Read Address	States of Vector Graphics or bitmap
Read Address + 1	Position No. in the preset path.

**Address:** Refers to the first address of the word address corresponding to the Animation component.

**Word Length:** Displays the data length of the read address, which is fixed to "2".

#### 4 Switch to the [Animation] tab.

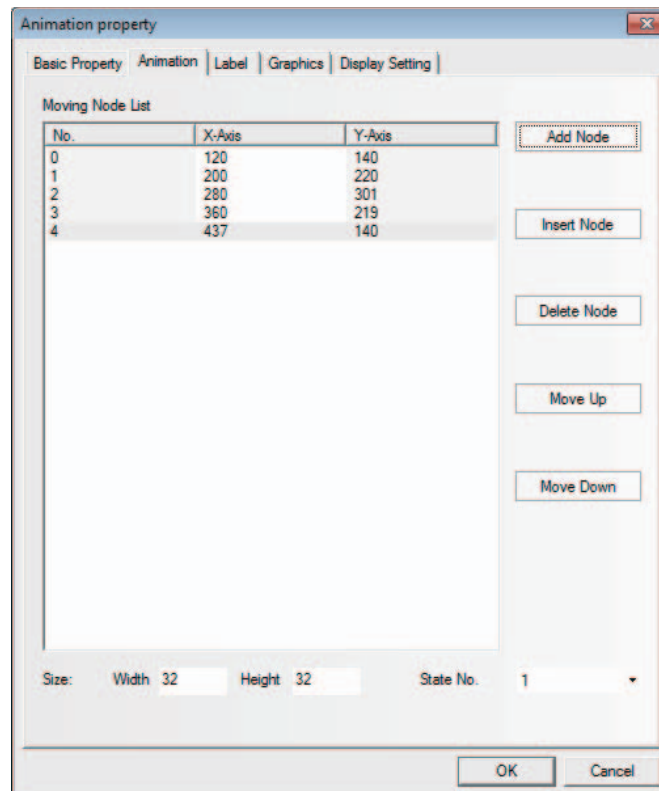

**State No.:** Selects the total states displayed by the Animation component. It determines the number of states of the Vector Graphics or bitmap displayed in the preset path.

**Add Node:** Adds one moving node in the end of the preset path.

**Insert Node:** Inserts one moving node after the moving node pointed by the mouse.

**Delete Node:** Deletes one moving node.

**Move Up:** Moves the moving node pointed by the mouse into the place before the previous node.

**Move Down:** Moves the moving node pointed by the mouse into the place after the next node.

**Graphics Size (Width/Height):** This is the size of Animation Components displayed on the path. On all moving nodes, vector graphics or bitmap are displayed in the state which was resized with the parameter specified by this item.

**Moving Node List:** Displays all the numbers and coordinate values for all the track nodes, and No.0 is for the 1<sup>st</sup> moving node, and No.1 is for the 2<sup>nd</sup> moving node, and so on. The total number of the moving node is determined by the number of moving node when you put the component in the PT at the beginning. X(Y) represent the coordinate position corresponding to the moving node, and you can reset the coordinate position for each moving node here.

- 5 Switch to the [Label] tab and add the corresponding texts to be displayed.
- 6 Switch to the [Graphics] tab and select Vector Graphics or bitmap to move or display the state.
- 7 Press the [OK] button to complete the setup of the Animation component.

### 3-6-10 Number Input



The Number Input component can be used to display the current data contained in word address inside a specified PT or of PLC, to input data through the pop-up keyboard and to change the data contained in this address by pressing “ENTER” button.

#### ● Process of adding one Number Input component

- 1 Press the Number Input component icon, drag it to the screen, then the [Basic Properties] dialog box of the Number Input component will pop up.

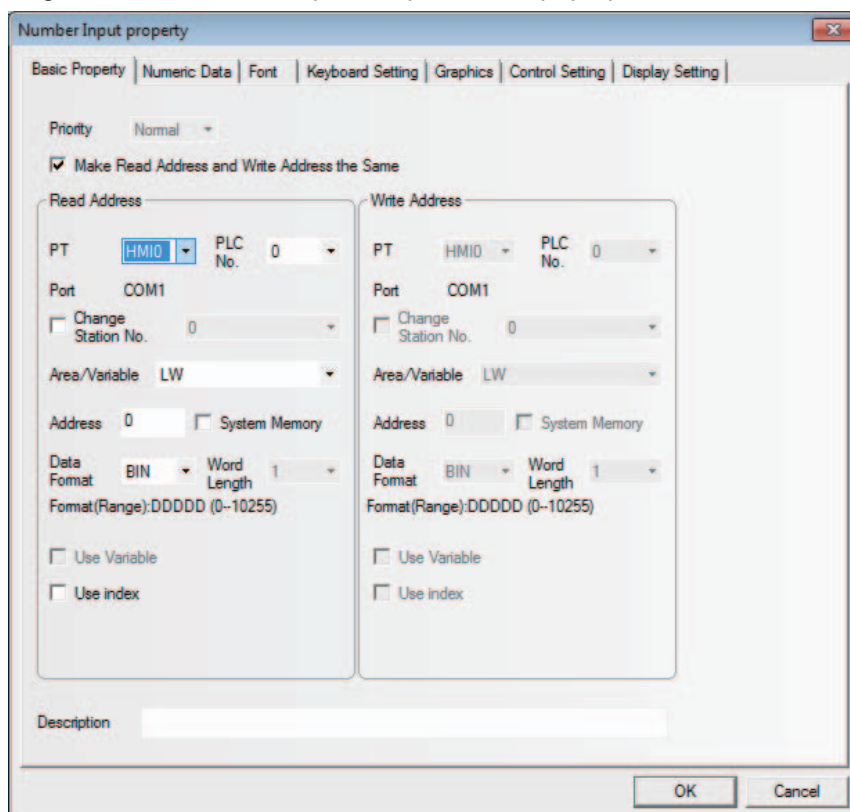

**Read/Write Addresses:** Refers to the specified word address read and written by the Number Input component.

**Address:** Refers to the first address of the word address corresponding to the Number Input component.

**Word Length:** Displays the data length of the address.

## 2 Go to the [Numeric Data] tab.

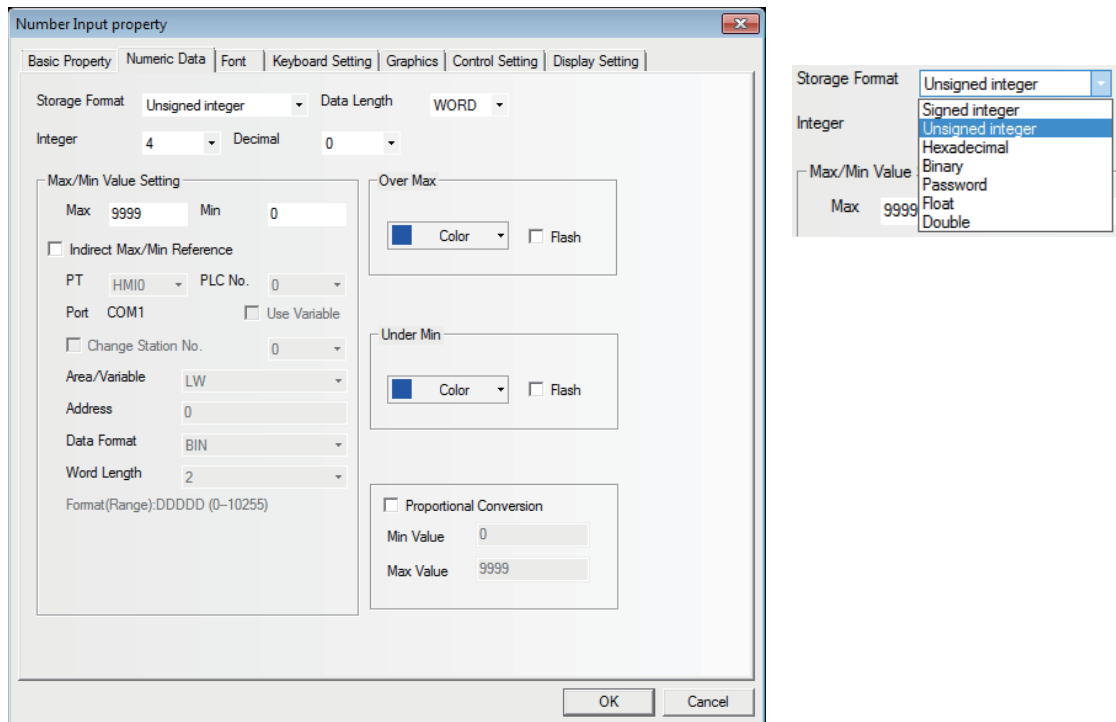

**Data Format:** Sets the data format corresponding to data contained in specified word address and 7 types are available.

**Max/Min Value Setting:** Setting the range of input available value.

**Over Max/Under Min:** Specifying color of the value displayed when it exceeds the Max or the Min of the value.

**Flash:** When the value of the specified word address is greater than the Max or less than the Min, the value of the component will be flashed to make the transfinite alarm more visible.

**Proportional Conversion:** The value of the specified word address will be converted according to the settings and displayed on number input component. To select this function, [Min Value] and [Max Value] must be set.

**For example:** it is assumed that the original data is represented by "A" and the displayed data by "B", then the data B can be obtained by the following conversion formula:

$$B = [\text{Minimum Proportional Value}] + (A - [\text{Minimum Value of Original Data}]) \times \text{Proportion}$$

Where, Proportion =  $([\text{Maximum Proportional Value}] - [\text{Minimum Proportional Value}]) / ([\text{Maximum Value of Original Data}] - [\text{Minimum Value of Original Data}])$

Take the following graphics as example, when the original data is 20, then the value after conversion is  $15 + (20-0) \times (55-15) / (100-0) = 23$ , so the value displayed in the component will be 23.

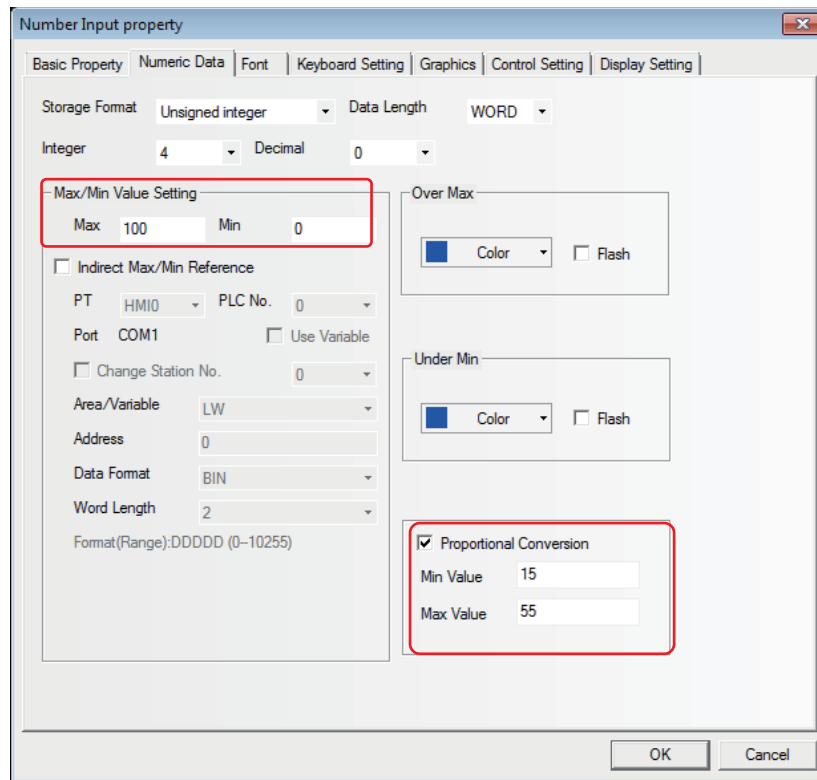

- 3** Switch to the [Font] tab and set the font size, color and alignment method, etc. for the displayed value.

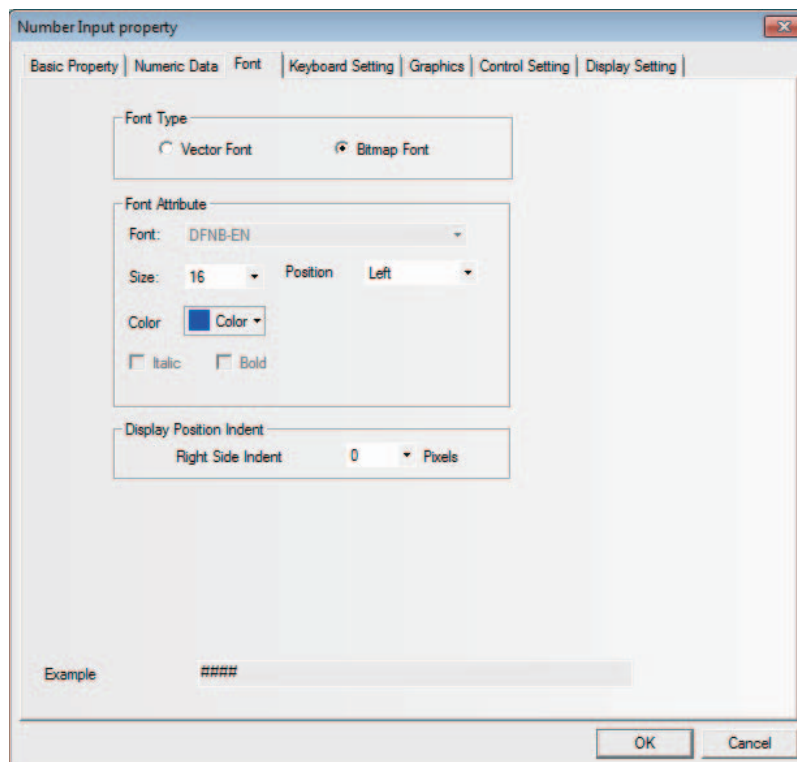

**Font Size:** Sets the size of the font.

**Position:** Sets the displayed position of the value. For example, set “Integer”, “Decimal” and the input value to “5”, “0” and “23” respectively, then the formats as shown below will be displayed.

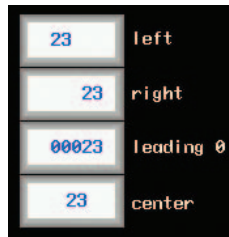

**Display Position Indent:** Increases the width of the display area for the font rightward with the unit of pixel point.

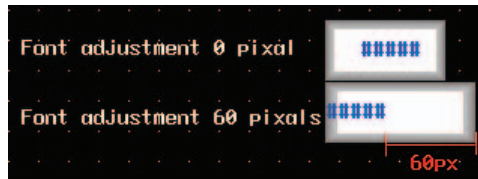

- 4 Switch to the [Keyboard Setting] tab and make Keyboard Setting for the pop-up keyboard type and check Use Input Order.

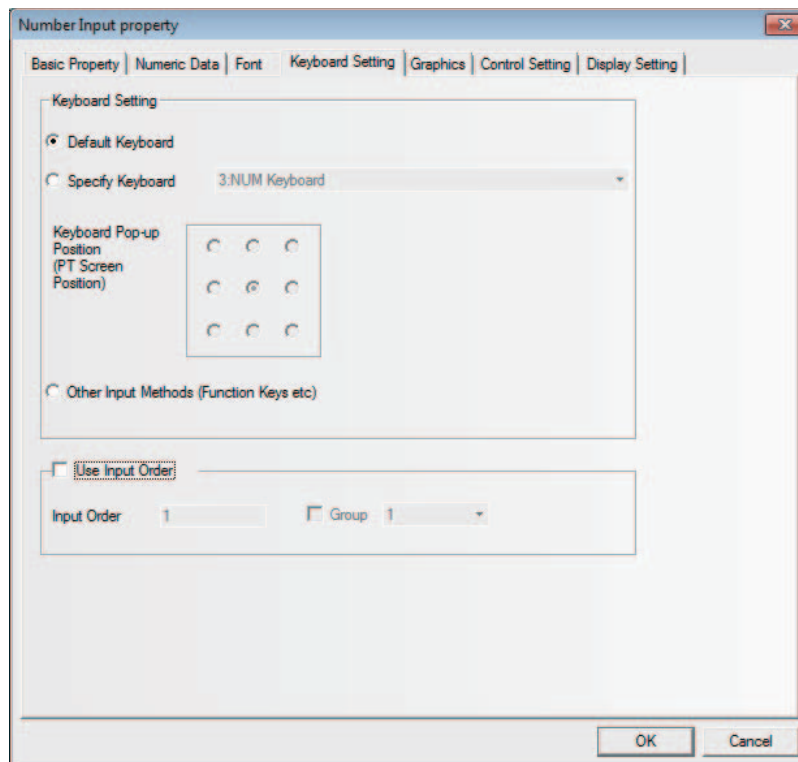

**Default Keyboard:** Refers to the keyboard used by the Common Sheet, all of the Number Input components will call the 3:NUM keyboard. The default setting of Number Input is “Use [Default Keyboard]”.

**Specified Keyboard:** One specified keyboard will be called and only after checking in the [Screen Attribute] check box of the [Screen Property] dialog box for the page set by function keys and others and setting [Keyboard] for [Screen Property], the keyboard can be displayed in the dropdown list of the [Specify Keyboard].

**Keyboard Pop-up Position:** 9 positions can be adjusted.

**Other Input Methods (Function Key etc):** Using the function keys, the keyboard is specified when entering numbers.

**Use Input Order:** In the order of number input of [Input Order] specified to number input, text input, or Note book, numbers and text strings can be entered continuously. Touching [Enter] during data entry allows to move the cursor among input components in the order of the numbers of [Input Order] which were specified by [Use Input Order] (Ascending order: 1-->2-->...-->last No.-->1-->...) In this settings, the keyboard will not be closed automatically and will be kept to be displayed on the screen until touching to [X] (closing component) displayed on the keyboard.

**Group** is used to classify the multi-group of components needing consecutive inputs. The components with the same group number belong to the same group, and the cursor will be cyclic in the same group of components. When the "Enter" is pressed, the keyboard will not be closed automatically, but will always be displayed in the screen until the close button "X" in the keyboard is touched.

Setting of [Use Input Order]

Go to [Keyboard Setting] Property tabs for the Number Input component, Text Input component and Note Book component respectively, and check the [Use Input Order].

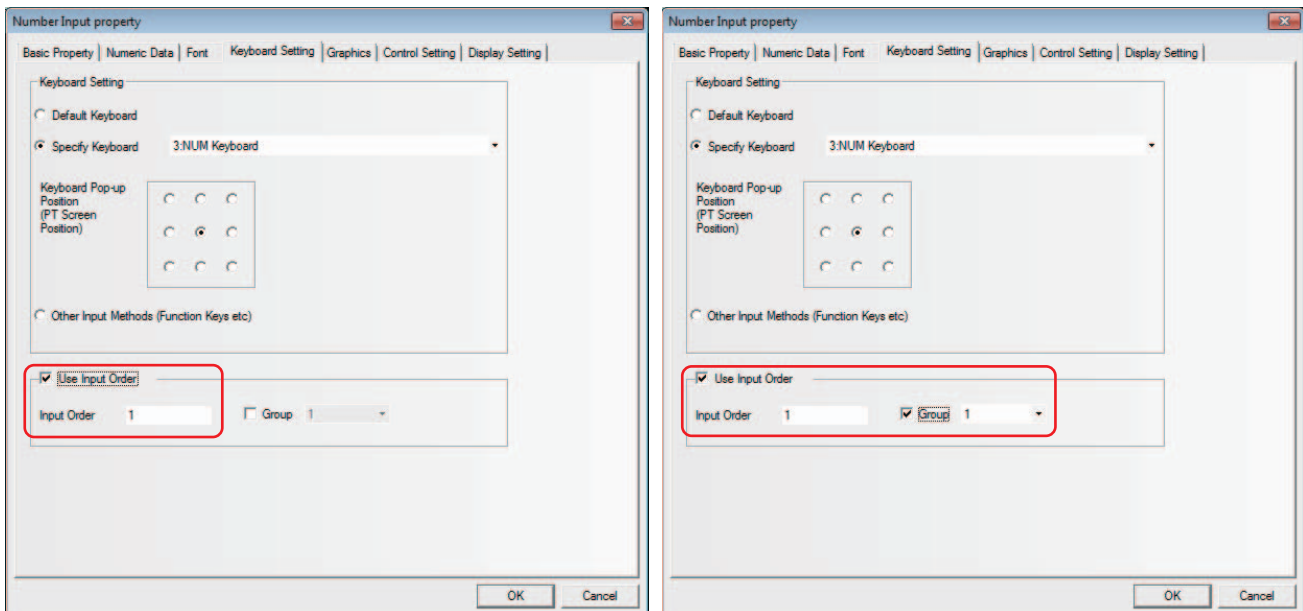

- 5** Switch to the [Graphics] tab and select the Vector Graphics or bitmap representing the touching area and touching state.
- 6** Switch to the [Control Setting] tab and make the Security Setting and set the Triggering action.
- 7** Press the [OK] button to complete the setup of the Number Input component.

#### Storage Format:

##### (1) Decimal System (signed int/unsigned int):

The data is displayed in decimal (0~9).

The data is displayed according to the instructions for the digits after the decimal point and the data will be arranged from the digits after the decimal point. For example, the digits after the decimal point is 2, then "14561" will be displayed as "145.61". "-"(minus) is treated as an integer.

**Data after Proportional Conversion:**

The value of the communication addresses set is converted proportionally before displaying. The conversion formula is as follows.

$$\text{Value after Proportion Conversion} = \frac{\text{Minimum Value after Proportion Conversion}}{\text{Minimum Input Value}} \times \left( \frac{\text{Read Value} - \text{Minimum Input Value}}{\text{Maximum Input Value} - \text{Minimum Input Value}} \right) \times \left( \frac{\text{Maximum Value after Proportion Conversion} - \text{Minimum Value after Proportion Conversion}}{\text{Maximum Input Value} - \text{Minimum Input Value}} \right) + \text{Minimum Value after Proportion Conversion}$$

The converted value will display the data according to “the digits before the decimal point” and “the digits after the decimal point”. For example, the value to be converted is 123.456, but “the digits after the decimal point” and “the digits before the decimal point” are “2” and “3” respectively, so the converted value is displayed as “123.45” and the last digit is cut.

**(2) Hexadecimal System (hex):**

The data is displayed in hexadecimal format (0~F), and the conversion ratio and the decimal point are eliminated.

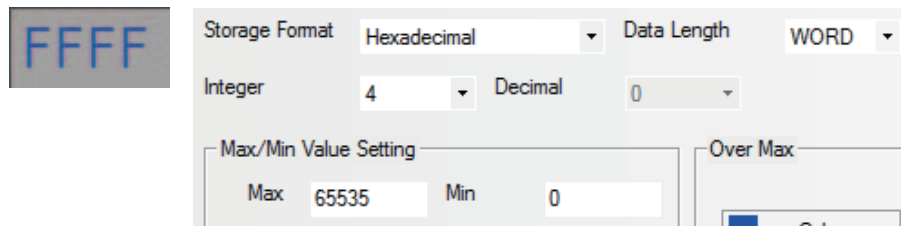
**(3) Binary System (bin):**

The data is displayed in binary format (0 and 1), and the conversion ratio and the decimal point are eliminated.

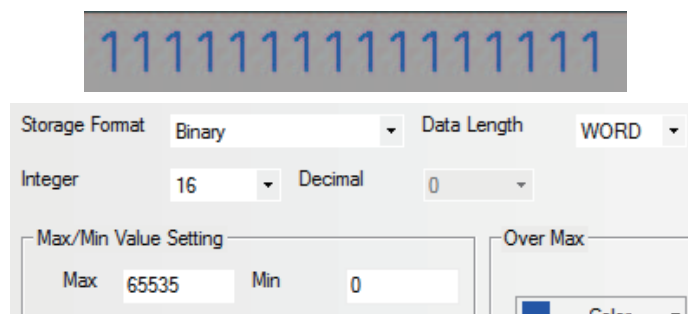

In the hexadecimal and binary formats, the input maximum value or minimum value are treated as unsigned integer.

**(4) Password (password):**

Only “\*\*\*\*\*” can be displayed and all the values to be read are hidden, and it is used to input the password. Its conversion ratio and the decimal point are eliminated.

**(5) Single-precision Floating-point Value (float):**

The data in the controller will be converted into the decimal data from the data in 32-digit IEEE floating format and will be displayed in decimal format.

**(6) Double-precision Floating-point Value (double):**

The data in the controller will be converted into the decimal data from the data in 64-digit IEEE floating format and will be displayed in decimal format.

For details about the single-precision floating-point value and double-precision floating-point value, refer to IEEE-754 Standard.

### 3-6-11 Number Display



Number Display

The Number Display component is used to display the data in the specified word memory.

#### ● Process of adding one Number Display component

- 1 Press the Number Display component icon, drag it to the window, then the [Basic Properties] dialog box of the Number Display component will pop up.

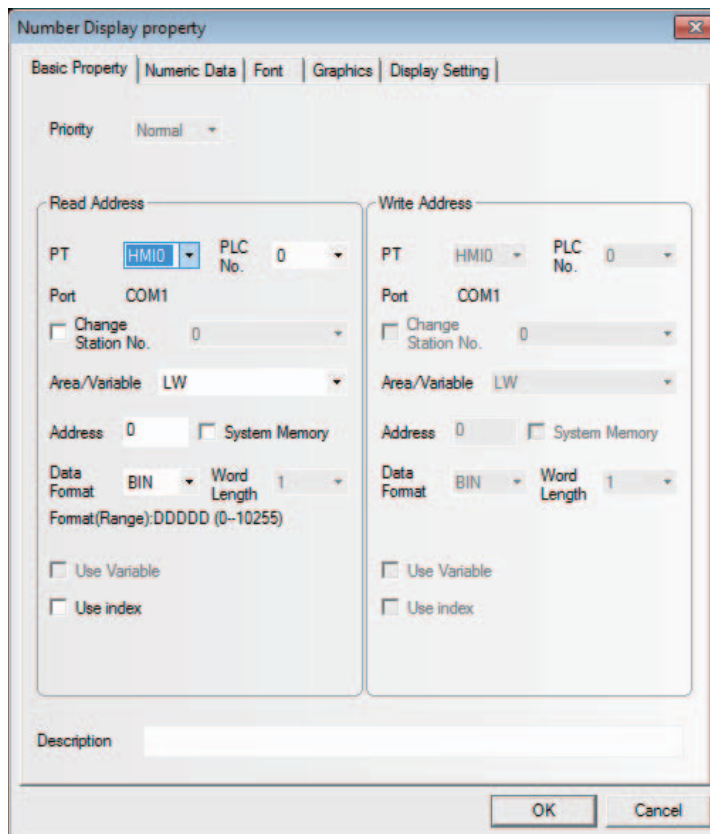

**Read Address:** Refers to the word address displayed by the Number Display component.

**Address:** Refers to the first address of the word address corresponding to the Number Display component.

**Word Length:** Displays the data length of the read address.



- 2 Refer to the relevant contents of the [Number Input] component, and fill in the contents in the [Numeric Data] tab.

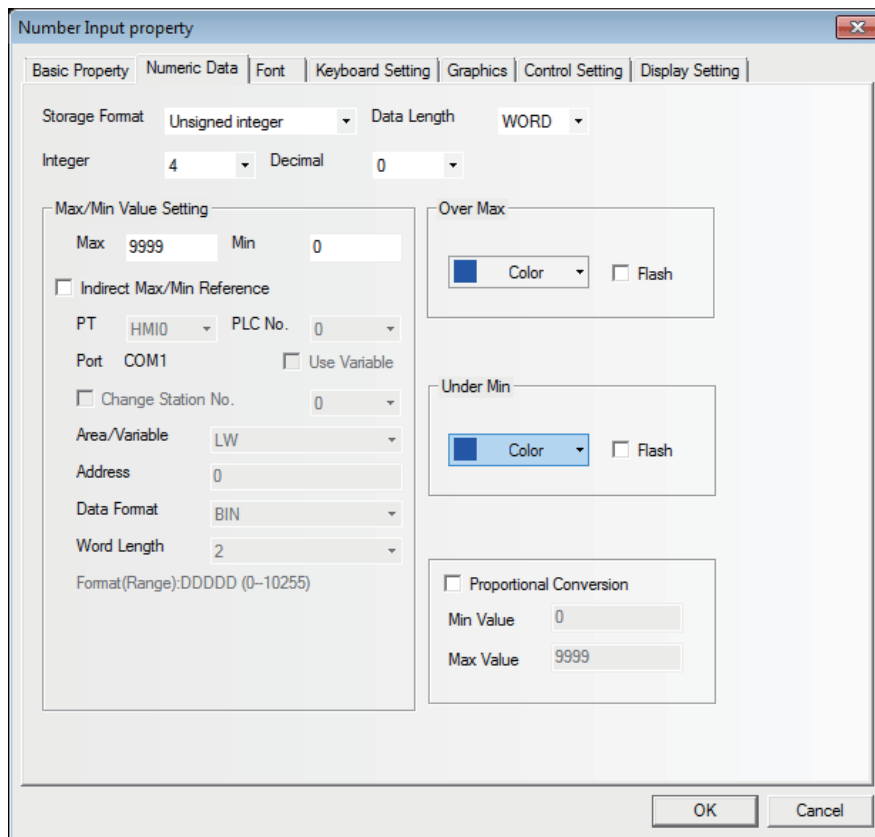

- 3 Switch to the [Font] tab and make related settings referring to the Number Input component.



- 4** Press the [OK] button to complete the setup, and place the Number Display component in a proper position.
- How to use the “Proportional Conversion” in the Numeric Data tab in Number Display Component Property dialog box.

Quite a number of PLCs or other controllers don't support decimals or negatives, and in many cases, the actual values registered in PLCs or other controllers are different from the values the users want to display on the PT, thus Proportional Conversion is required. For example, the actual frequency of an inverter is 0~5000, while what is expected on the PT is 0~50 HZ, and in this case, Proportional Conversion can be used.

Another example: the range of values sampled from the PLC is 6400~32000, while the range desired to be displayed on the PT is 0.00~2.00.

This can be realized with settings shown below:

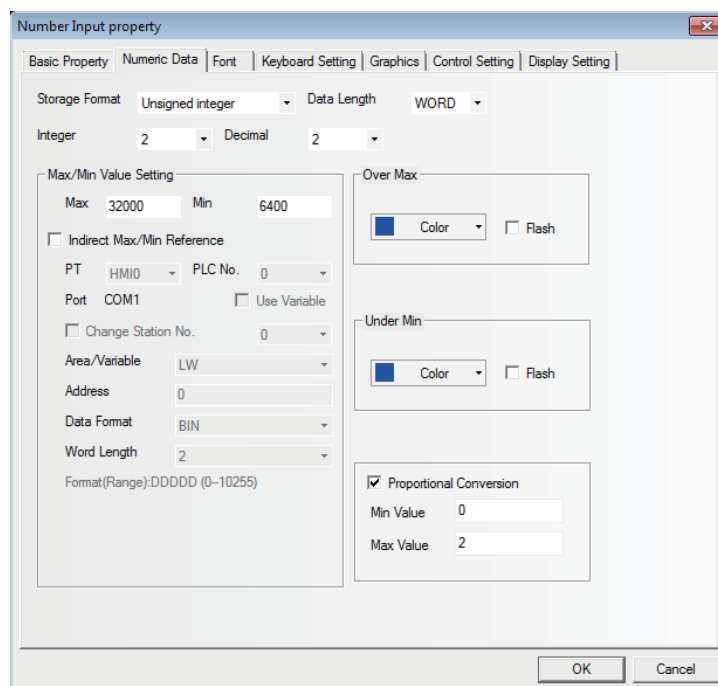

## 3-6-12 Text Input



Text Input

Text Input component can modify or display the data in the specified word memory, which is analyzed through the standard ASCII character table as default settings. The input data is saved to a consecutive memory with the "Registered Address" as the first address. Low-byte character codes are displayed on the left, while high-byte character codes are displayed on the right.

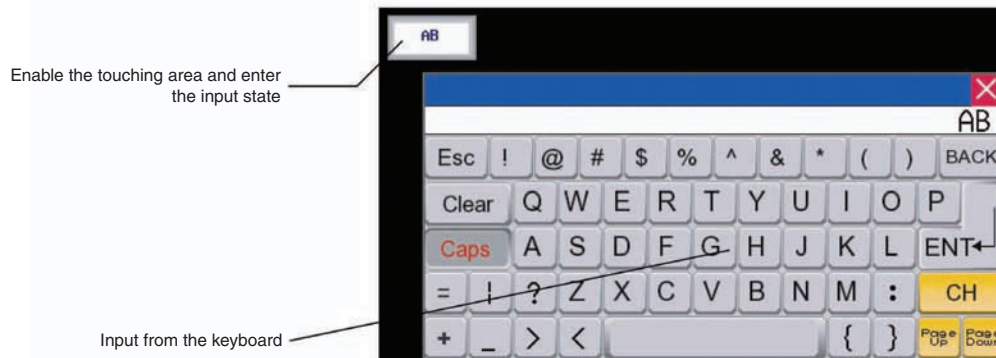

### ● Process of adding one Text Input component

- 1 Press the Text Input component icon, drag it to the window, then the [Basic Properties] dialog box of the Text Input component will pop up.

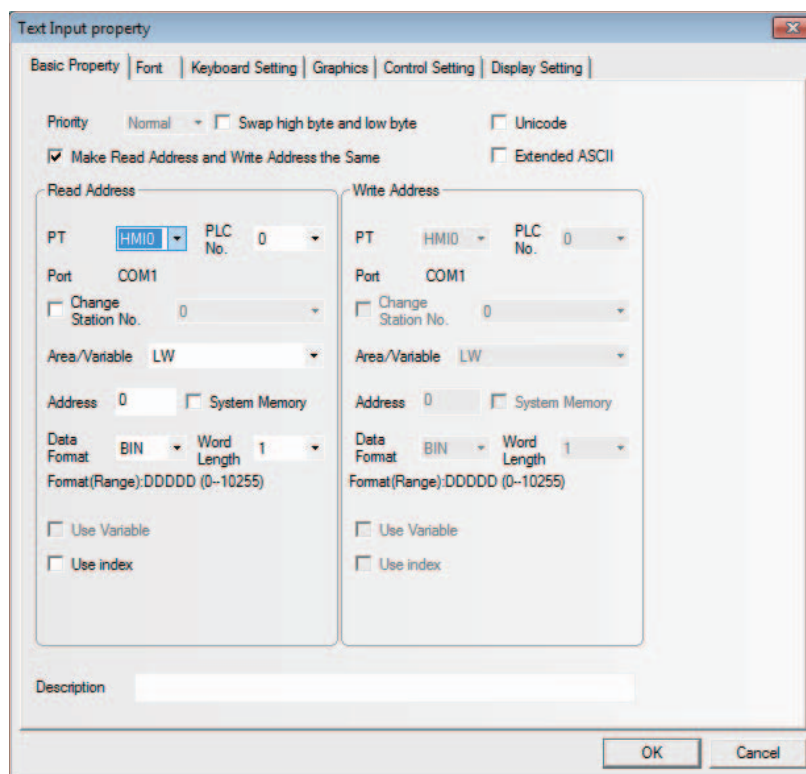

**Swap high byte and low byte:** Refers to the interchange of the high-byte and the low-byte for the same byte, as shown below.

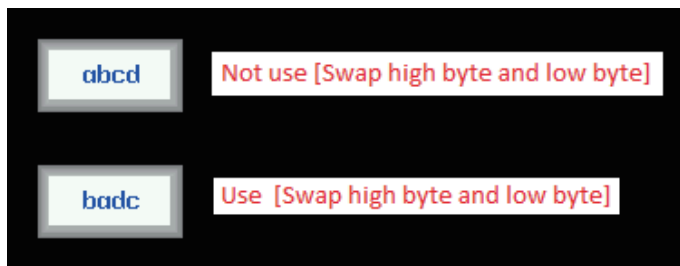

**Unicode:** If you check the check box for this function, the specified data is dealt as Unicode.

**Extended ASCII:** Checking this option can display the extended ASCII characters between 0x80 and 0xff in the ASCII codes. When it is checked, Chinese can't be displayed in the Text Input component, Text Display component and Note Book component. Only one of [Unicode] or [ASCII] can be selected.

**Read/Write Address:** Refers to the word address (It contains up to 16 words, each of which contains 2 ASCII characters) displayed and modified by Text Input component in PLC.

**Address:** Refers to the first address of the word address corresponding to the Text Input component.

**Word Length:** 1~16 are available for the Read/Write Address.

**2** Switch to the [Font] tab and fill in the Properties of displayed data referring to that for the Number Input component.

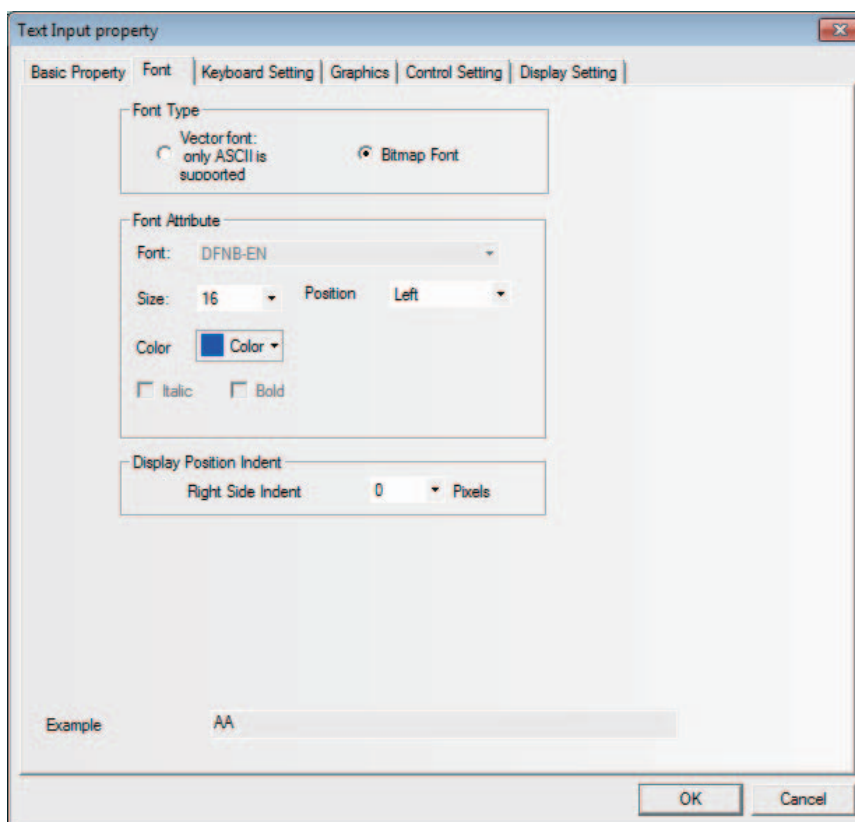

- 3 Switch to the [Keyboard Setting] tab and select the keyboard type.

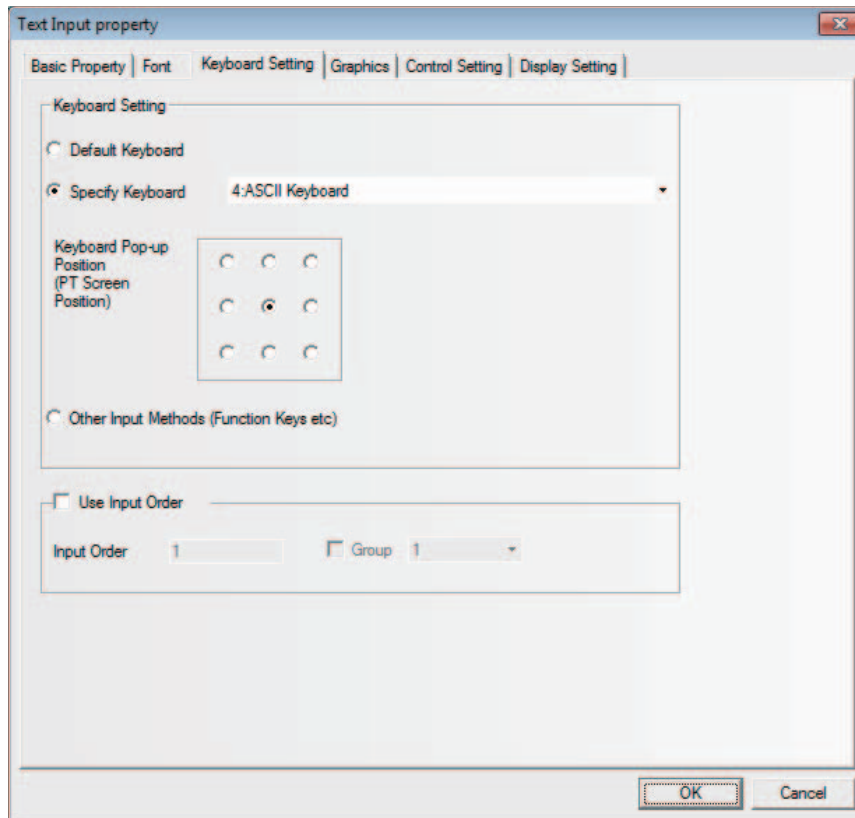

- 4 Switch to [Graphics] tab and select the Vector Graphics or bitmap representing the touching area and touching state.
- 5 Switch to the [Control Setting] tab and make the Security Setting and set the Triggering action.
- 6 Press the [OK] button to complete the setup of the Text Input component.

**The storage method of the text input is explained as below.**

(1) Select [Left] in [Alignment] of [Font Property]

When the character “A” is input A

Highest Word		Word 2		Word 1		Lowest Word (Word 0)	
High byte	Low byte	High byte	Low byte	High byte	Low byte	High byte	Low byte
20(H)	20(H)	20(H)	20(H)	20(H)	20(H)	20(H)	41(H)
							A

When characters “AB” are input AB

Highest Word		Word 2		Word 1		Lowest Word (Word 0)	
High byte	Low byte	High byte	Low byte	High byte	Low byte	High byte	Low byte
20(H)	20(H)	20(H)	20(H)	20(H)	20(H)	42(H)	41(H)
						B	A

When characters "ABC" are input 

Highest Word		Word 2		Word 1		Lowest Word (Word 0)	
High byte	Low byte	High byte	Low byte	High byte	Low byte	High byte	Low byte
20(H)	20(H)	20(H)	20(H)	20(H)	43(H)	42(H)	41(H)
					C	B	A

(2) Select [Right] in [Alignment] of [Font Property]

When the character "A" is input 

Highest Word		Word 2		Word 1		Lowest Word (Word 0)	
High byte	Low byte	High byte	Low byte	High byte	Low byte	High byte	Low byte
41(H)	20(H)	20(H)	20(H)	20(H)	20(H)	20(H)	20(H)
A							

When characters "AB" are input 

Highest Word		Word 2		Word 1		Lowest Word (Word 0)	
High byte	Low byte	High byte	Low byte	High byte	Low byte	High byte	Low byte
42(H)	41(H)	20(H)	20(H)	20(H)	20(H)	20(H)	20(H)
B	A						

When characters "ABC" are input 

Highest Word		Word 2		Word 1		Lowest Word (Word 0)	
High byte	Low byte	High byte	Low byte	High byte	Low byte	High byte	Low byte
43(H)	42(H)	41(H)	20(H)	20(H)	20(H)	20(H)	20(H)
C	B	A					

### 3-6-13 Text Display

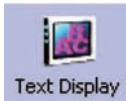

The Text Display component can display data in the specified word memory, which is analyzed through the standard ASCII character table in default settings. Low-byte character codes are displayed on the left, while high-byte character codes are displayed on the right.

#### ● Process of adding one Text Display component

- 1 Press the Text Display component icon, drag it to the window, then the [Basic Properties] dialog box of the Text Display component will pop up.

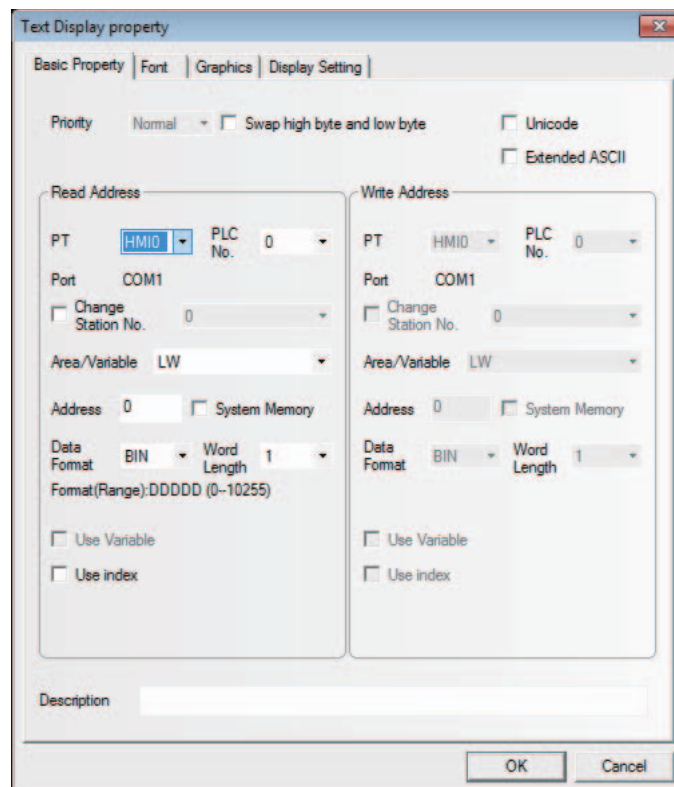

**Swap high byte and low byte:** Refers to the interchange of the high byte and the low byte for the same byte, as shown below.

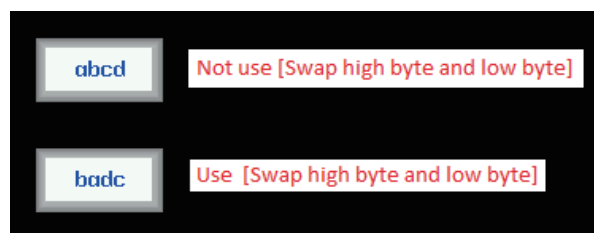

**Unicode:** If you check the check box for this function, the specified data is dealt as Unicode.

**Extended ASCII:** Checking this option can display the extended ASCII characters between 0x80 and 0xff in the ASCII codes. When it is checked, Chinese can't be displayed in the Text Input component, Text Display component and Note Book component. Only one of [Unicode] or [ASCII] can be selected.

**Read Address:** Refers to word address memory of PLC to be displayed (It contains up to 16 words, each of which contains 2 ASCII codes).

**Address:** Refers to the first address of the word address corresponding to the Text Display component.

**Word Length:** Displays the data length of the read address with 1 to 16 available.

- 2** Switch to the [Font] tab and set the font size, alignment and color of the text to be displayed.



- 3** Switch to the [Graphics] tab and select the Vector Graphics or bitmap representing the touching area and touching state.
- 4** Switch to the [Control Setting] tab and make the Security Setting and set the Triggering action.
- 5** Press the [OK] button to complete the setup of the Text Display component.

### 3-6-14 Level Meter



The value specified of the communication address is displayed in level picture based on the upper limit value and the lower limit value set by [Level Meter Property].





As shown as below, the user can customize Level Meter with any desired shape.

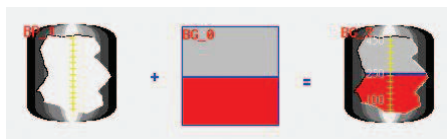

● **Process of adding one Level Meter component**

- 1** Press the Level Meter component icon, drag it to the window, then the [Basic Properties] dialog box of the Level Meter component will pop up.

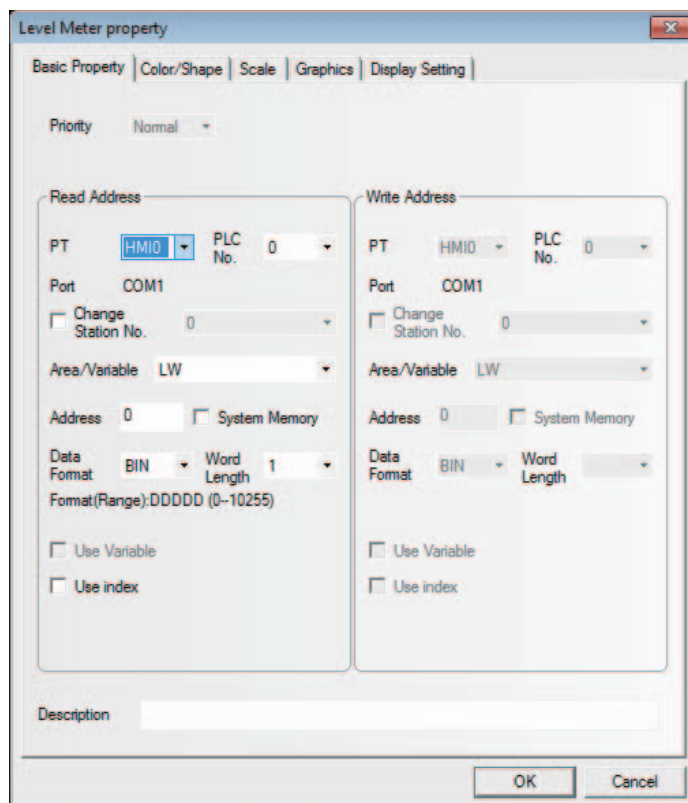



**Read Address:** Refers to the first address of the word address corresponding to the Level Meter component.

**Word Length:** Displays the data length of the read address, supporting sing-word and double-word.

**2** Switch to the [Color/Shape] tab and make settings as shown below.

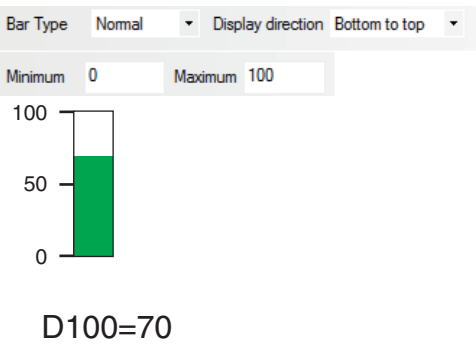
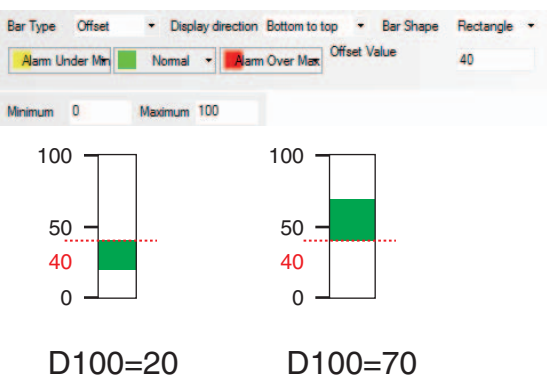
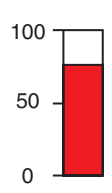
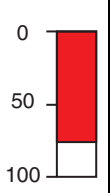
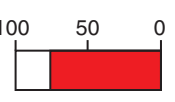
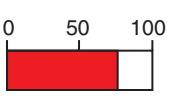

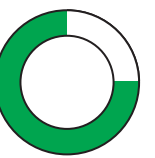
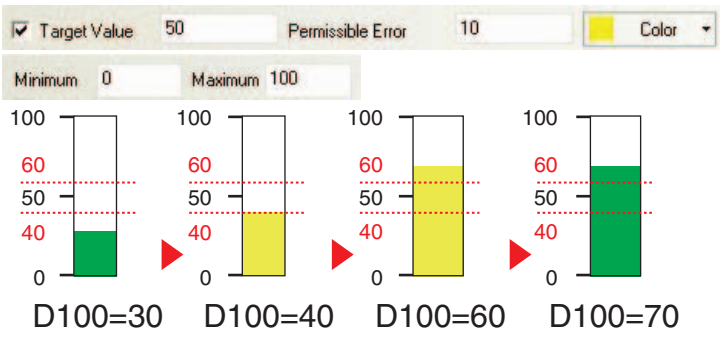
Detailed descriptions of the Level Meter Properties						
Bar Type	Normal	Indicates the percentage relationship between the actual value and the set range by means of a Level Meter. 				
	Offset	Displaying the value over the [Offset] for the actual value by means of a Level Meter. Example: Maximum 100, Minimum 0, Offset Value 40 				
Bar Shape	Rectangle			Circle		
Display direction	Bottom to Top	Top to Bottom	Right to left	Left to Right	Clockwise	Counterclockwise
						
Target Value	When the value of the specified memory falls to the range [target value [allowable] gap] specified to the [Allowable gap], the fill area of the Level Meter will be displayed in the specified color. 					
Meter Width	When the Level Meter is of a Circle shape, the width of the fan can be set with the unit of pixel point.					
Start Angle	When the Level Meter is of a Circle shape, the Start Angle of the fan can be set.					
End Angle	When the Level Meter is of a sector shape, the End Angle of the sector ring can be set. If the start angle is different from the end angle, shape of the meter will be fan-shaped.					

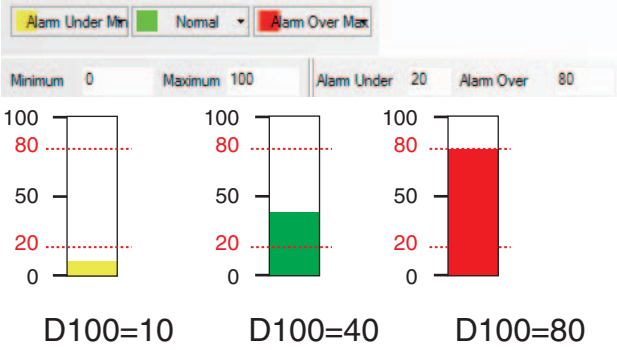
Detailed descriptions of the Level Meter Properties	
Color	This option is used to set the colors for the normal state, warning the upper or lower limit value, border and background of the Level Meter.
Flash Over Max	When the value of the specified memory exceeds the set Alarm Upper, the filled area of the Level Meter flashes.
Flash Under Min	When the value of the specified memory falls below the set Alarm Lower, the filled area of the Level Meter flashes.
Minimum/Maximum	Sets the upper and lower limit values of the display area for the Level Meter. The percentage of filled area in the Level Meter can be derived from the following formula: Percentage of filled area in the Level Meter = (Value read by the memory - [Minimum value])/([Maximum value] - [Minimum value]) ×100%
Indirect Max/Min Reference	Sets the upper, lower limit values and offset value of the Level Meter display area to be read from the specified memories.
Alarm Upper/Alarm Lower	Sets the range of the alarm area. When the value of the specified memory falls below the Alarm Lower or exceeds the Alarm Upper, the filled area will be displayed in the specified color. 
Indirect Alarm Over/Alarm Upper Reference	Sets the upper and lower limit values of the alarm area in the Level Meter display area to be read from the specified memories.

**3** Switch to the [Scale] tab and make settings as shown below.

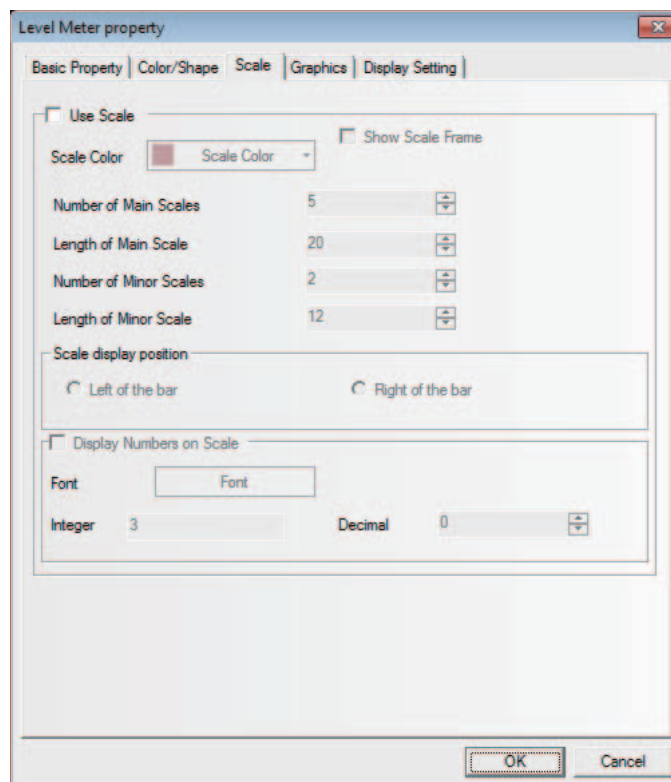

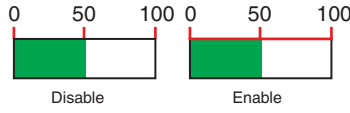
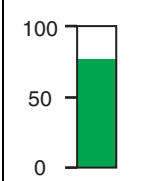
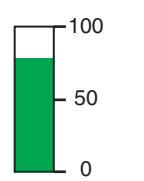
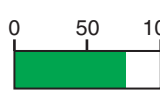
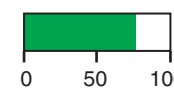
Scale Properties					
Use Scale	Scale Color	Sets the scale color of the Level Meter.			
	Show Scale Frame	Determines whether to show the scale frame.			
					
	Number of Main Scales	Sets the main scale number to be displayed.			
	Length of Main Scale	Sets the length of the main scale with the unit of pixel point.			
	Number of Minor Scales	Sets the minor scale number to be displayed.			
	Length of Minor Scale	Sets the length of the minor scale with the unit of pixel point.			
Scale display position	Left of the bar	Right of the bar	Top of the bar	Bottom of the bar	
					
	Display Number on Scale	Font	Sets scale font Properties.		
		Integer	Refers to the integer places displayed by the scale, which can't be changed by the user himself and is decided by the number of digits specified by the decimal.		
	Decimal	Refers to the decimal places displayed by the scale, which can be changed by the user himself.			

**Note** When the Level Meter is of a Circle shape, scale display is not supported.

**4** Switch to the [Graphics] tab and make settings as shown below.

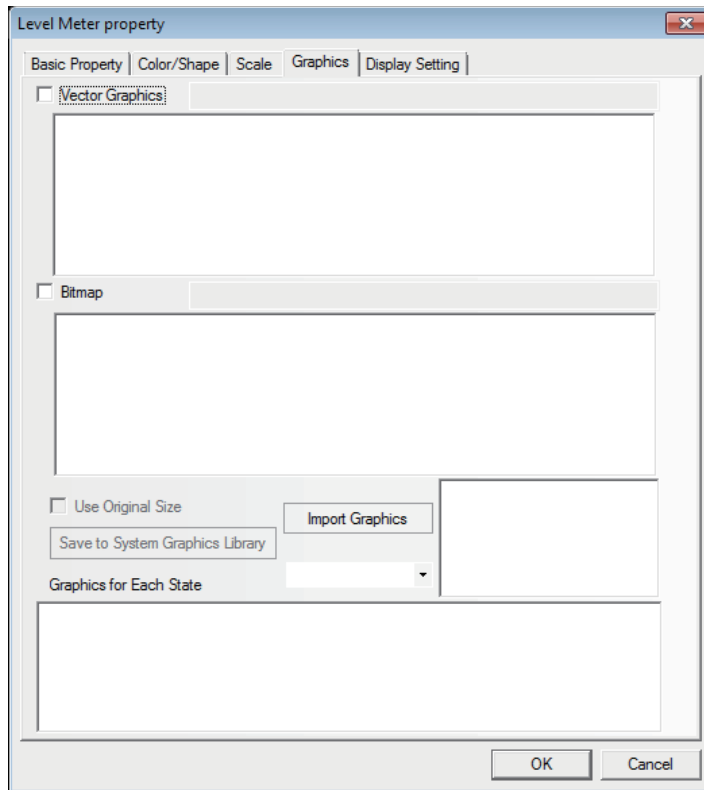

Select proper graphics for the Bar Picture to improve the display effect.

**5** Press the [OK] button to complete the setup of the Level Meter component.

- **Level Meter - Word**

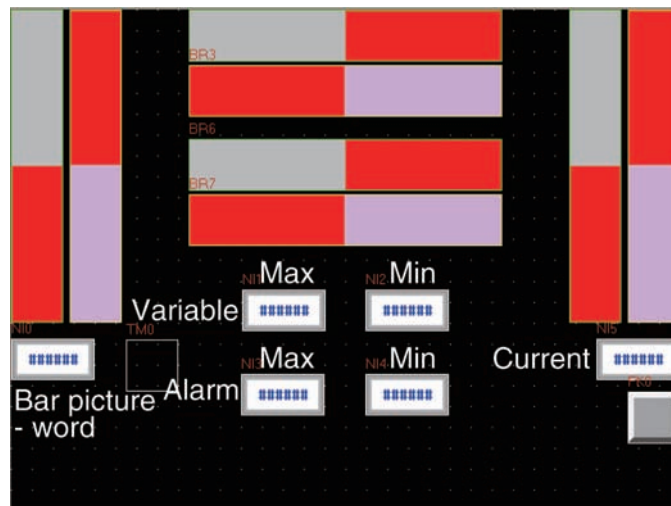

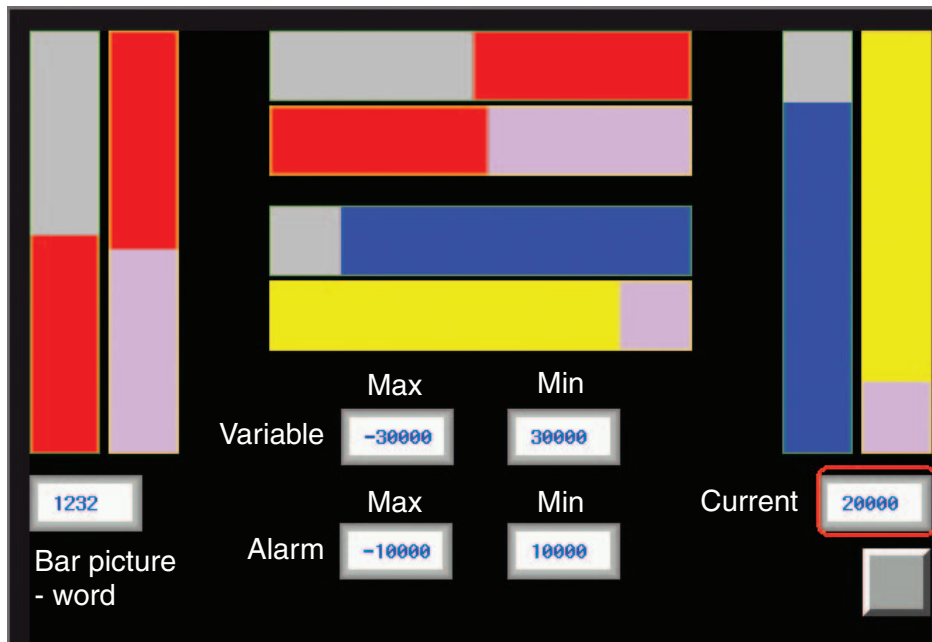
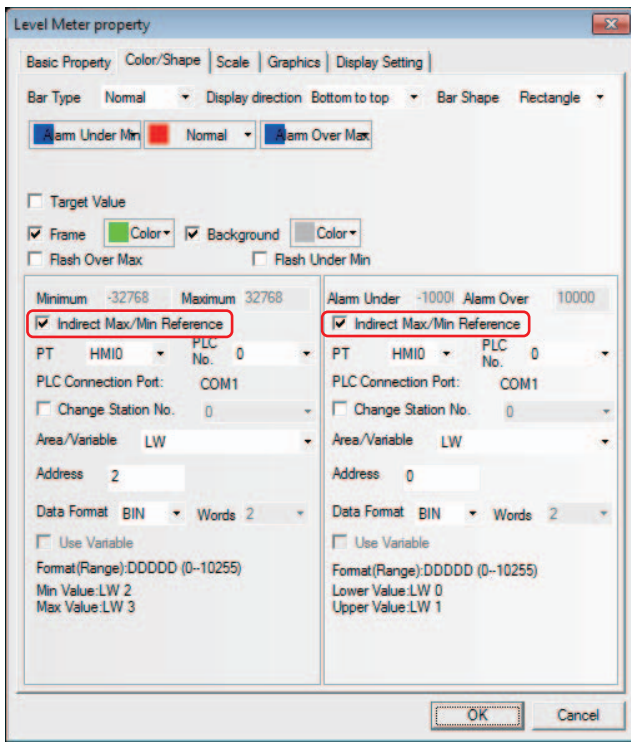
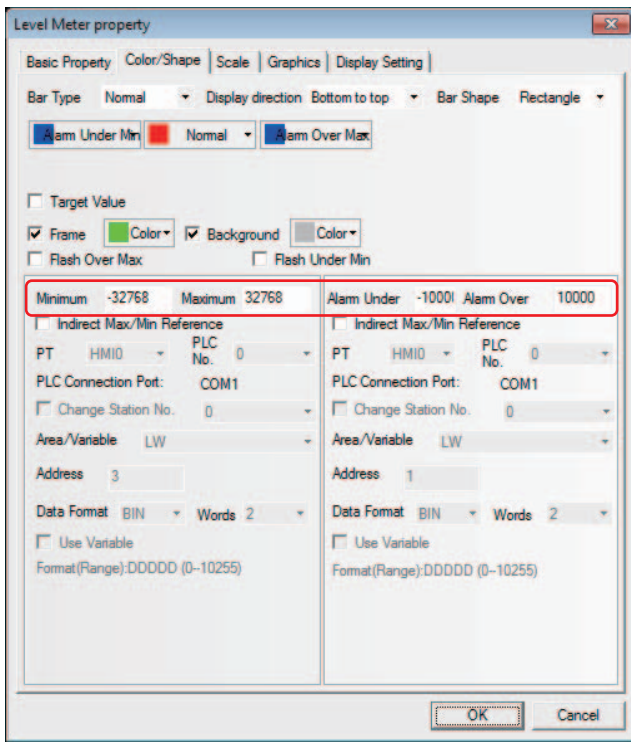

- Level Meter - Double-word

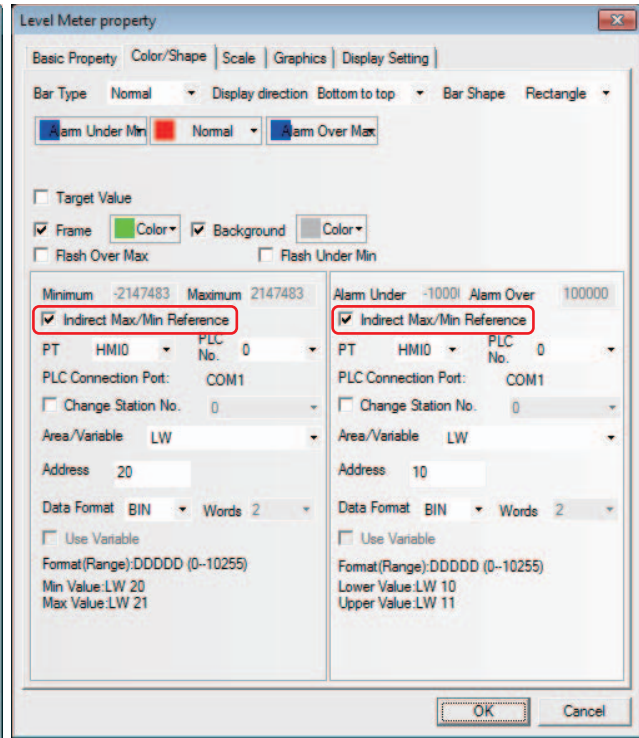
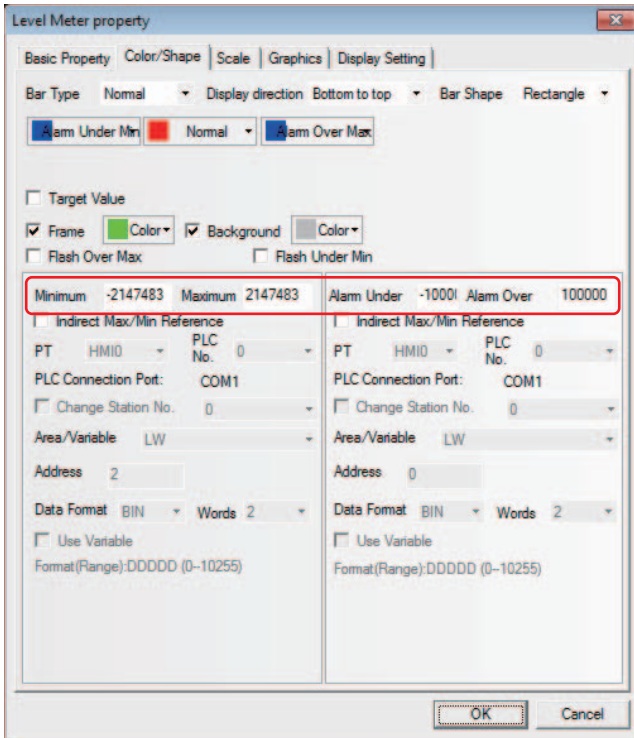
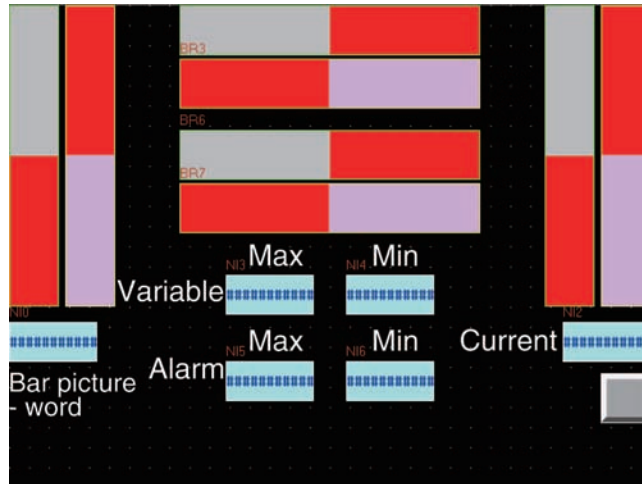



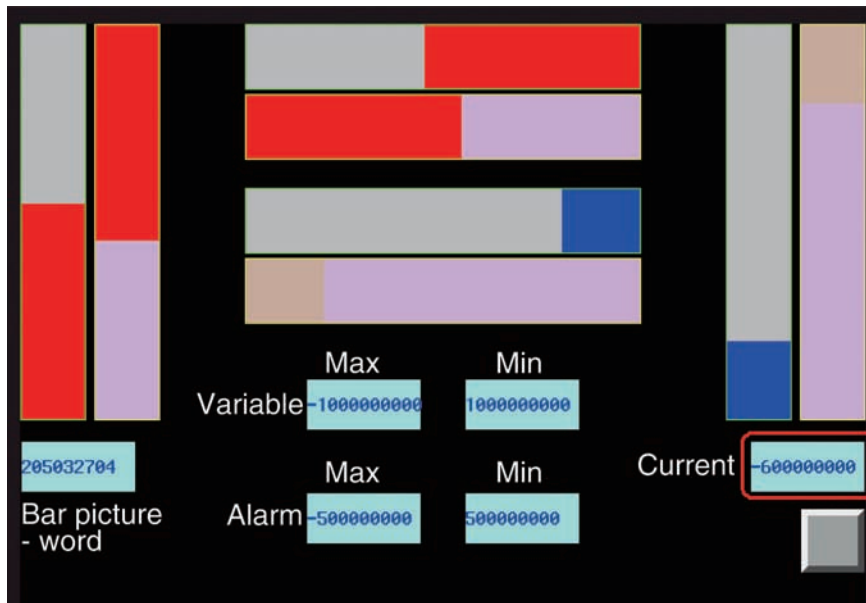



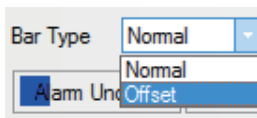

• **Normal and Offset**

When the [Offset] is selected, only the greater part of the values set by the offset value. For example, setting “50” to [Offset value] and storing “60” in the communications address, only the area corresponding to 50 to 60 of level meter will be filled.

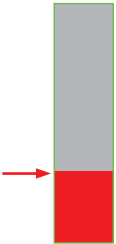

Comparison of display effects between Normal and Offset:

Normal	Offset
	
	
<p>Indicating the range from the current value to lower limit value.</p>	<p>Indicating the range from the current value to the [Offset].</p>

- **Rectangle and Circle**

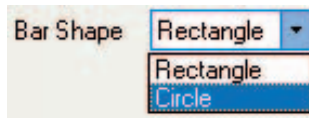

Comparison of display effects between the Rectangle and Circle.

Rectangle	Circle
Bar Type: Normal    Display direction: Bottom to top    Bar Shape: Rectangle	Bar Type: Normal    Display direction: Clockwise    Bar Shape: Circle Meter Width: 10    Start Angle: 0    End Angle: 360

### 3-6-15 Analog Meter



Analog Meter can display the data in the specified memory by means of a Analog Meter diagram.

#### ● Process of adding one Analog Meter component

- 1 Press the Analog Meter component icon, drag it to the screen, then the [Basic Properties] dialog box of the Analog Meter component will pop up.

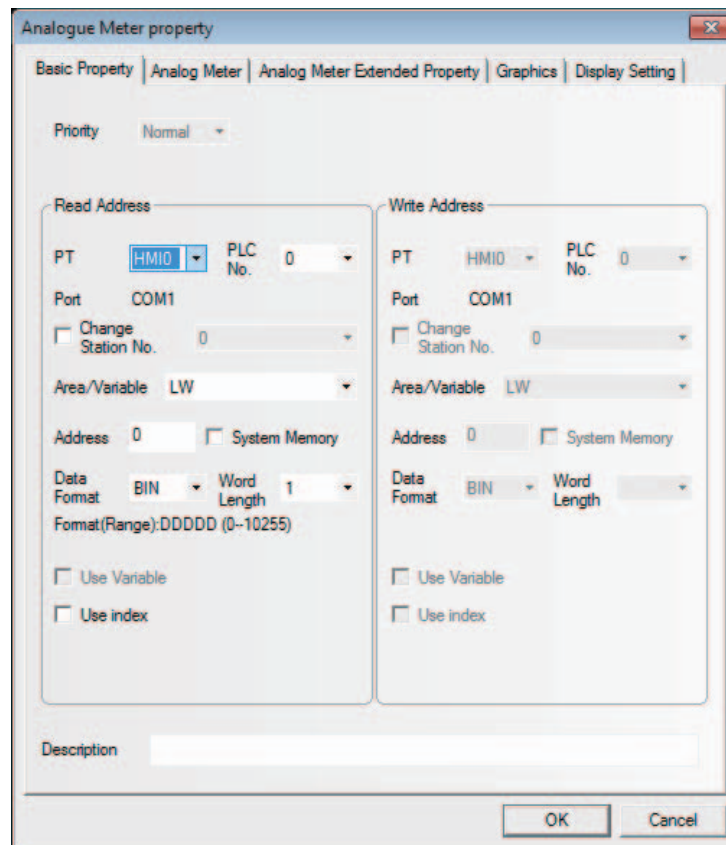



**Read Address:** Refers to the word address of the value displayed by the component.

**Address:** Refers to the first address of the word address corresponding to the Analog Meter component.

**Word Length:** 1 and 2 are available for the read address.

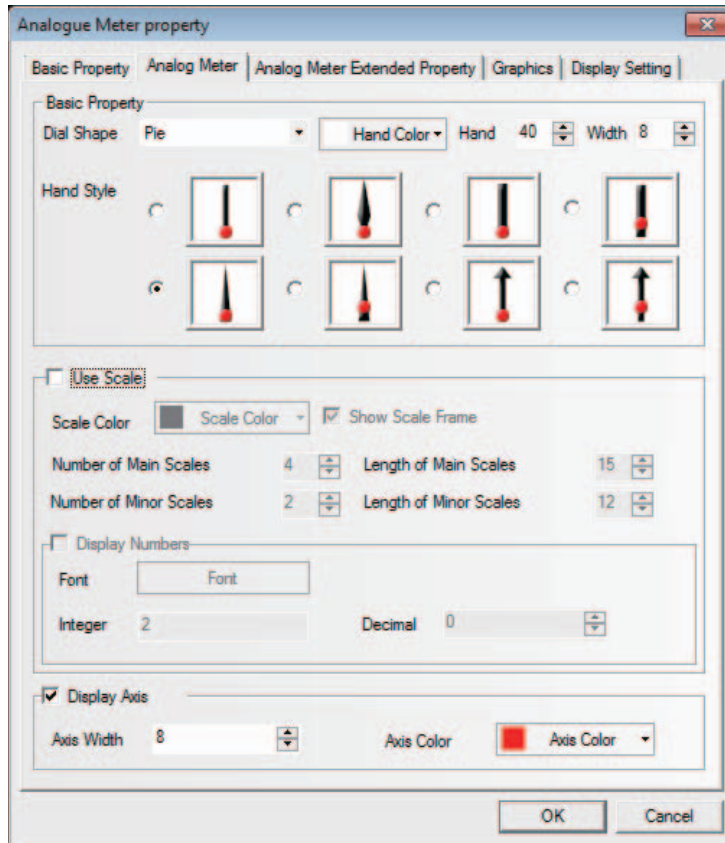
**2** Switch to the [Analog Meter] tab.

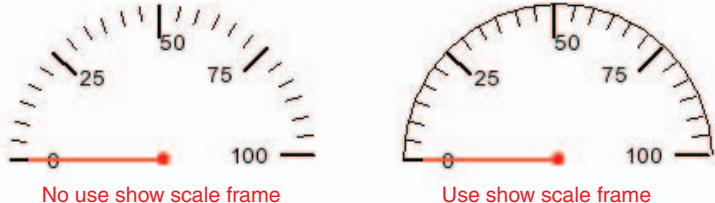

Descriptions of Analog Meter Component Properties	
Dial Shape	Includes Pie, Circularity (up pointer) and Circularity (down pointer). 
Hand Color	Selects the color of the hand of the Analog Meter component.
Length	Sets the length of the hand of the Analog Meter component. The maximum length cannot be longer than the radius of the meter.
Width	Sets the width of the hand of the Analog Meter component.
Hand Style	Sets the style of the hand of the Analog Meter component.
Use Scale	Check the check box to use the scale.
Scale Color	Selects the color of the display scale of the Analog Meter component.
Show Scale Frame	Checking it means the scale frame needs to be displayed. 
Number of Main Scales	Sets the number of the main scale of the Analog Meter component. (0 to 50 available)

Descriptions of Analog Meter Component Properties	
Length of Main Scales	Sets the length of the main scale of the Analog Meter component. The maximum length cannot be longer than the radius of the meter.
Number of Minor Scale	Sets the number of the minor scale of the Analog Meter component. (0 to 10 available)
Length of Minor Scale	Sets the length of the minor scale of the Analog Meter component. The maximum length cannot be longer than the radius of the meter.
Display Numbers	Checking it means the scale notation needs to be displayed.
Font	Clicking "Font" can set the font used by the scale notation.
Integer	Refers to the number of integer places of the scale notation of the Analog Meter component. (not settable, but adjusted automatically according to the number of places of the maximum value of the Analog Meter component)
Decimal	Sets the number of decimal places of the scale notation of the Analog Meter component. (0 to 8 available)
Display Axis	Checking it means the size and color of the dial axis of the Analog Meter component need to be set.
Axis Width	Sets the size of the dial axis of the Analog Meter component. The maximum width cannot be wider than the radius of the meter.
Axis Color	Sets the color of the dial axis of the Analog Meter component.

**3** Switch to the [Analog Meter Component Extended Property] tab.

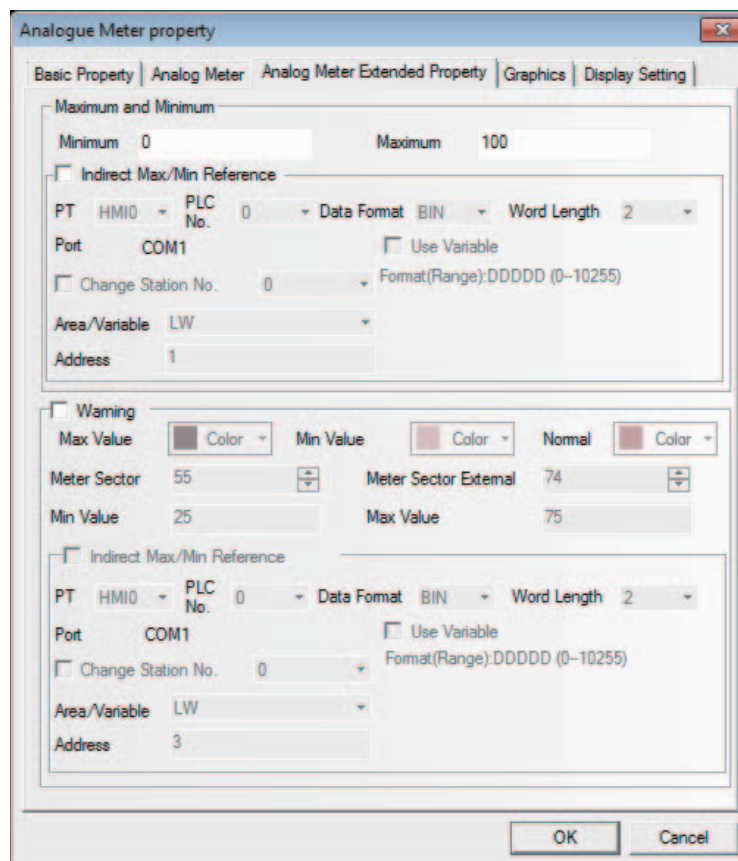

Descriptions of Analog Meter Component Extended Property	
Maximum and Minimum	Sets the display range of the Analog Meter component to the constants.
Indirect Max/Min Reference	The upper limit value and lower limit value of displaying range for the analog meter will be read from the value of specified address.
Warning	Checking it means the meter component displays by the color specifying the normal range and warning range (the range exceeds the upper limit value and the range falls the lower limit value).

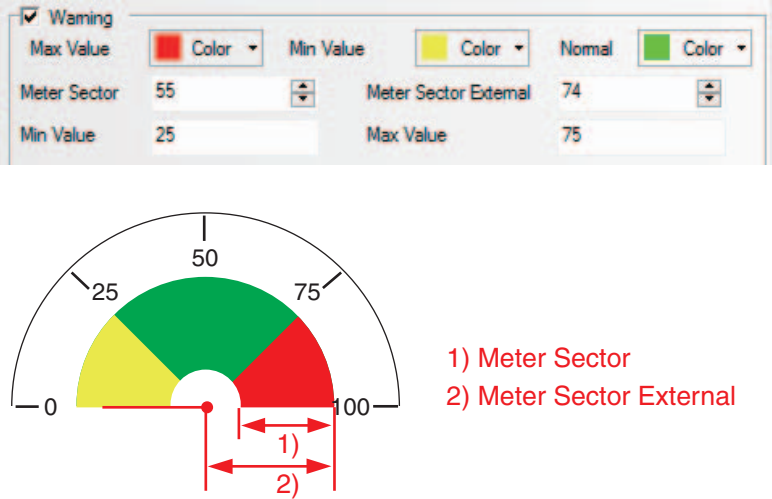
Descriptions of Analog Meter Component Extended Property	
Meter Sector	Sets the thickness of the alarm range and the thickness of the fan block. The maximum thickness can't exceed the radius of the actual circle formed by the Analog Meter component, but must be equivalent to or less than Meter Sector External
Meter Sector External	<p>Sets the radius of the fan block. The maximum radius can't exceed the radius of the actual circle formed by the Analog Meter component, but must be equivalent to or greater than the Meter Sector.</p>  <p>1) Meter Sector 2) Meter Sector External</p>
Max Value/Min Value	Sets the normal range of the Analog Meter component to constants.
Indirect Max/Min Reference	Sets the normal range of the Analog Meter component to variables, and specifies the memory address for reading data.

- 4** Switch to the [Graphics] tab and select the Vector Graphics or bitmap representing the touching area and touching state.
- 5** Press the [OK] button to complete the setup of the Analog Meter component.

### 3-6-16 Indirect Screen

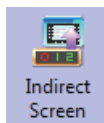

Indirect Screen can make an already created screen pop up on the current screen. Please refer to [3-4-3 Screen Creation]. Generally, the screen called by the Indirect Screen is smaller than the full screen (but it can also be of the same size as the full screen). In Indirect Screen specifications, pop-up displays the screen of the screen No. supporting the stored value of the word address specified to the [Read Address]. The number arranging indirect screens is not restricted in NB-Designer, but the pop-up screens can be displayed simultaneously up to 16 screens at max.

Value 0 is used to close the screen, and value -1 means to make screen 0 pop up, while the values other than 0 or -1 mean to make the corresponding screens pop up.

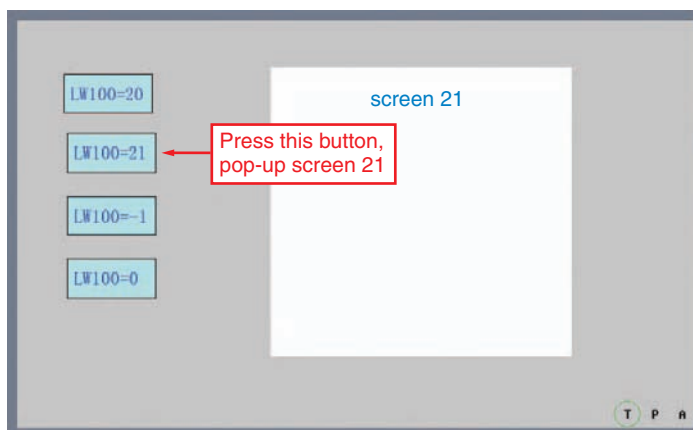
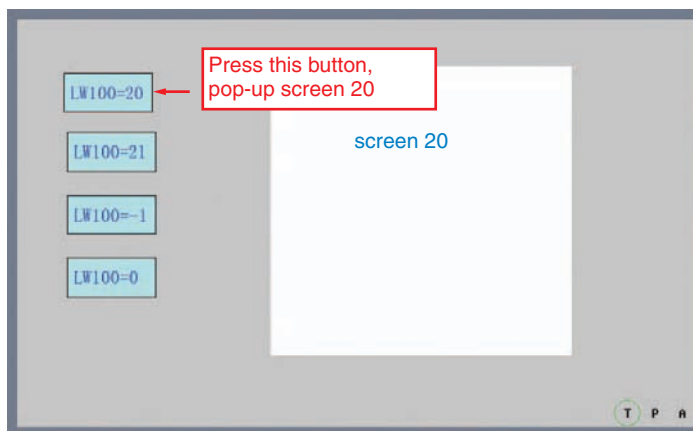
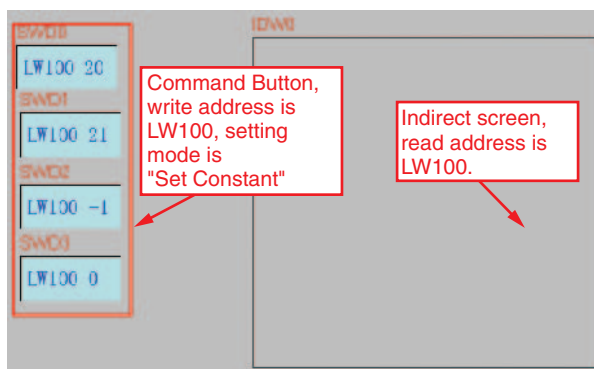

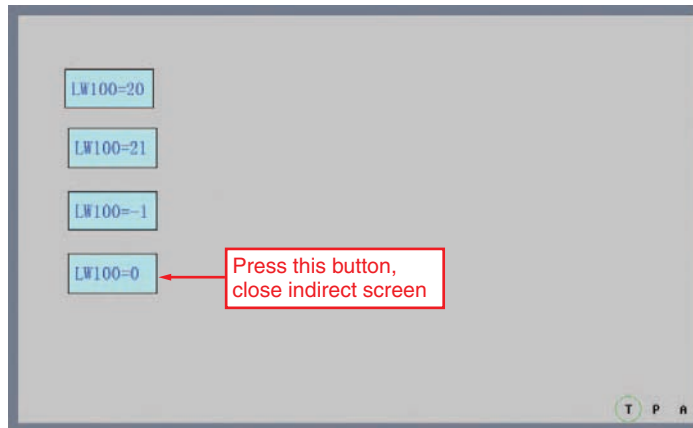
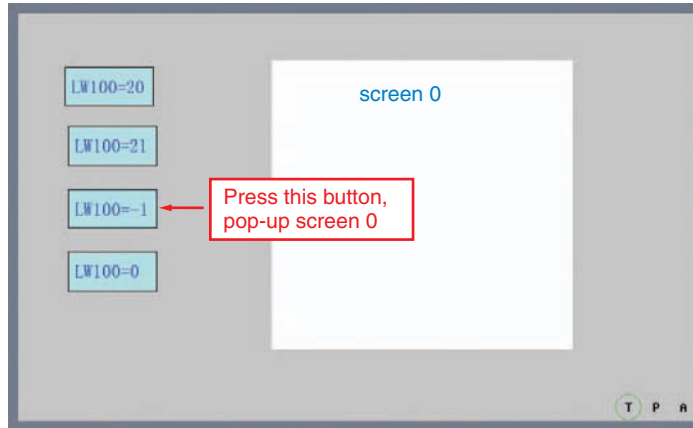

● **Process of adding one Indirect Screen component**

- 1** Press the Indirect Screen component icon, drag it to the screen, then the [Basic Properties] dialog box of the Indirect Screen component will pop up.

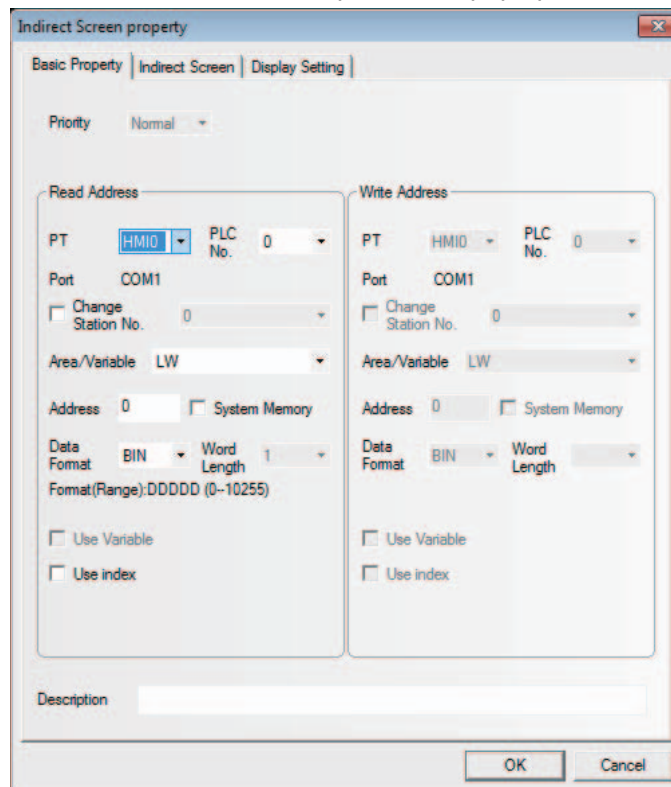



**Read Address:** It defines a display area and is able to display screen contents. The screen of the No. supporting the stored address specified to the read address will be displayed as pop-up screen. For example, if the value turns to 20, screen 20 will pop up (However, this screen must be created already.), while, when the value turns to 0, the Pop-up Screen will be closed. If the pop-up screen is closed using the function key, the value of the address specified to the read address cannot be updated. When closing the pop-up screen, set "0" to the read address.

**Address:** Specifies the word memory address storing the Indirect Screen No.

**Word Length:** Displays the data length of the read address, which is 1 by default.

- 2 Switch to the [Indirect Screen] tab and specify the displaying position of the screen which is displayed in the pop-up screen specified by the [Indirect Screen] and check "Indirect Reference of Display Position" for the Indirect Screen.

**Indirect Reference of Display Position:** Checking it means the position coordinates of the popup Indirect Screen are read by the specified memories; and Not-checking means the position coordinates of the popup Indirect Screen will depend on where the component is placed in the screen.

**X coordinate** and **Y coordinate** are controlled by the specified address and the "specified address + 1" respectively.

- 3 Press the [OK] button and properly adjust the position and the size of the Indirect Screen component.

The size of the Indirect Screen limits the display area of the pop-up screens. The pop-up screen area that goes beyond the Indirect Screen edge will not be displayed. Related function keys can be added to move or minimize the screens (Refer to the "**Pop-up screen title bar**" and "**Minimize**" in 3-7-2 *Function Key* (Page 3-201) in *NB-Designer Operation*).

**Task Bar:** If the pop-up screen comes with the [Pop-up screen title bar] and [Minimize] function keys, each time a screen pops up, a small icon supporting the pop-up screen will be reserved for this screen in the task bar. Pressing the small icon for this screen will push the corresponding screen to the top of the screen. Pressing the icon for the second time will minimize the screen, and another click will restore it to its initial state.

### 3-6-17 Direct Screen



Direct Screen can make a specified screen pop up onto the current screen. The pop-up screen will be displayed within the area of the [Direct Screen]. Normally, the Direct Screen size should be set to same as that of the pop-up screen. There is no absolute limitation on the number of Direct Screen. However, a maximum of 16 Direct Screens can be displayed simultaneously during operation. The closing or opening of the Direct Screen is only determined by the bit address of the [Read Address] that control it, while Function Key can't be used to close it. When this bit address is ON, the screen will pop up, and when it is OFF, the screen will be closed.

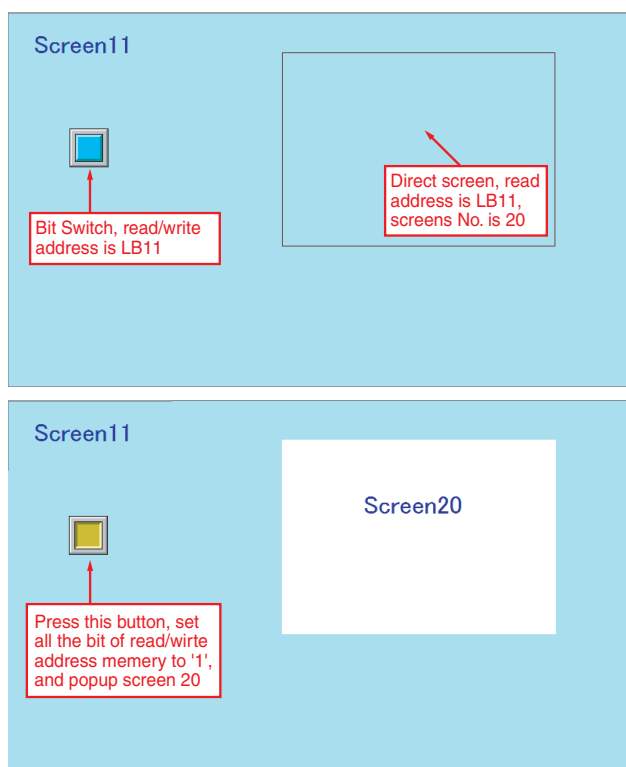

#### ● Process of adding one Direct Screen component

- 1** Press the Direct Screen component icon, drag it to the screen, then the [Basic Properties] dialog box of the Direct Screen component will pop up.

**Read Address:** When the specified read address is ON, the content of the specified screen will be displayed in the Direct Screen component area.  
If the pop-up screens is closed using a function key, the value of the address specified by the read address cannot be turned OFF. When closing the pop-up screen, set "0" to the read address.

**Address:** Specifying the address controlling the display of the pop-up screen.

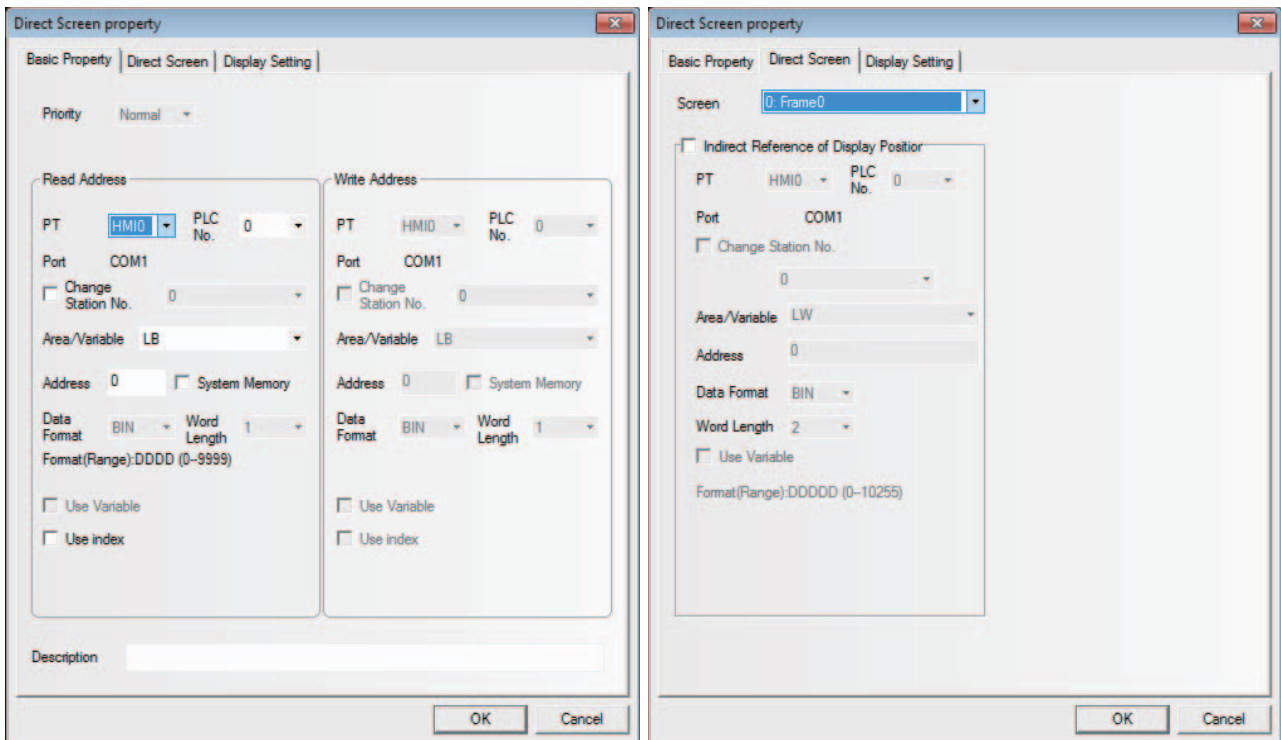

- 2 Switch to the [Direct Screen] tab and select the Destination Screen No. to be ejected in [Screen].

**Indirect Reference of Display Position:** Checking it means the position coordinates of the popup Direct Screen are read by the specified memories; and Not-checking means the position coordinates of the popup Direct Screen will depend on where the component is placed in the screen.

X Coordinate of Pop-up Screen	Y Coordinate of Pop-up Screen
First address	First address + 1

The position of the pop-up screen is controlled by 2 memories, i.e. the **X coordinate** is controlled by the First address, while the **Y coordinate** is controlled by the “First address + 1”.

But for some special PLCs (such as S7-200 etc.), the address must be an even number. For example, VW80 is the memory controlling X coordinate, and VW82 is that controlling Y coordinate.

- 3 Press the [OK] button to complete the setup, and adjust the position and the size of the Direct Screen component. The size of the screen will limit the display area. The pop-up screen area that goes beyond the Direct Screen edge will not be displayed. Function keys can be used to move or minimize the screens. Please refer to the contents related to the function key such as “Pop-up screen title bar” and “Minimize”, etc. in 3-7-2 Function Key (Page 3-201) in NB-Designer Operation.

### 3-6-18 Alarm

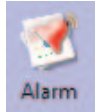

The Alarm component will display all the alarm information enabled in the set area. The content it displays is the same as that displayed by the Alarm Display, and both of them are about the alarm information of a certain node switch (bit address). When the bit address which worked as alarm trigger is released, the alarm display will be removed. The alarm information displayed by the alarm is necessarily registered by "Alarm Setting". When multiple alarms occur, the alarms will be displayed in the order descending to the newer (the top is the oldest and the bottom is the newest).

#### ● Process of adding one Alarm component

- 1 Press the Alarm component icon, drag it to the screen, then the [Basic Properties] dialog box of the Alarm component will pop up.

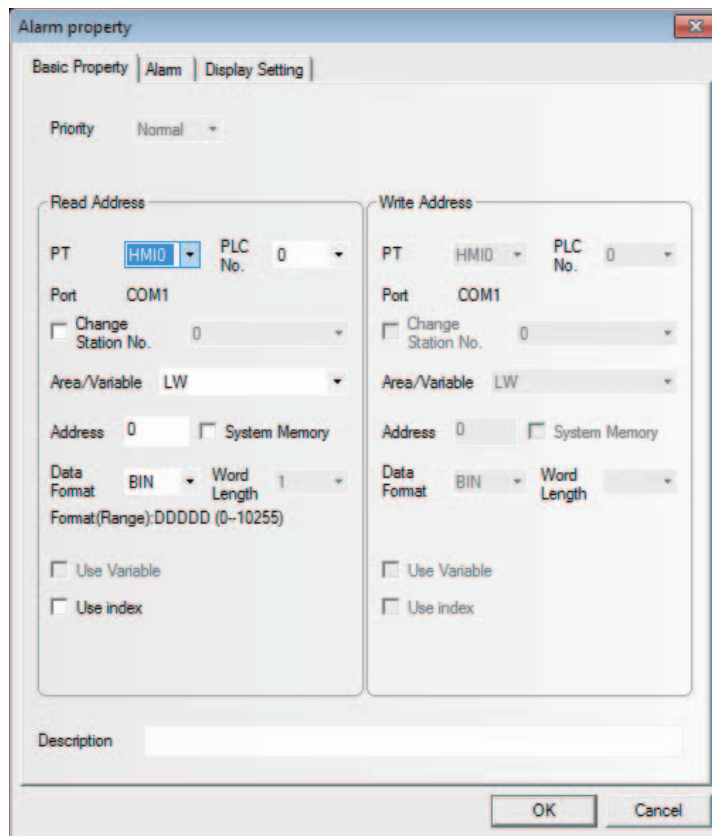

**Read Address:** The address specifying the display of the alarm is specified. All the alarm information is displayed from the latest to the oldest, i.e. if the value of the read address is N, the Nth alarm will be displayed on the first line, the alarm of the smaller No. than N will be removed.

**Address:** Refers to the word address using for controlling display.

**Word Length:** Displays the data length of the read address, which is 1 by default.

- 2** Go to the [Alarm] tab, as shown below:

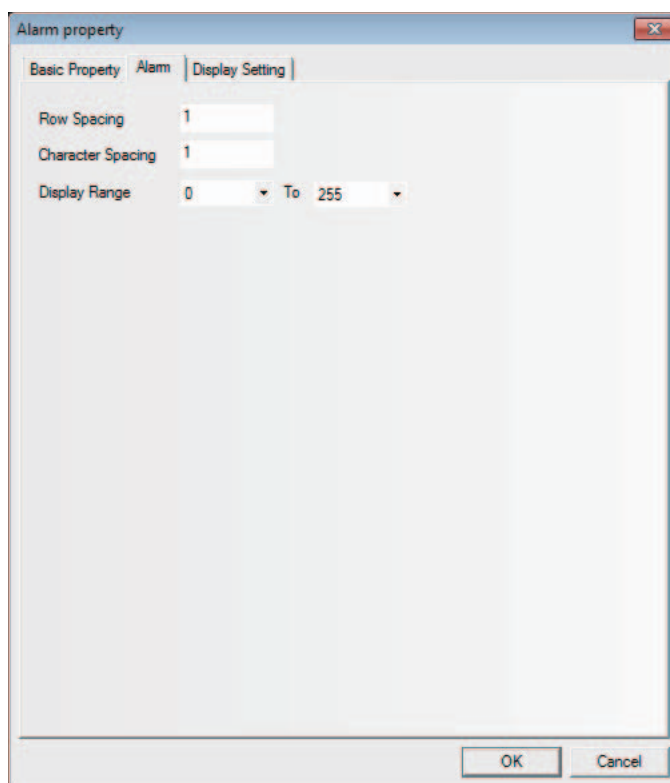

**Row Spacing and Character Spacing:** Specifying the row space and character space of the displayed alarm. Graphic font ignores this setting.

**Display Range:** "0 To 255" are available. When memory the alarm information, you need to assign a type for each piece of alarm information. For example, 3 pieces of information are registered, with 0, 1 and 2 as their types. Add an Alarm component in the screen, and set the [Display Range] to "0 To 1". Then when all of the 3 alarms occur, set to the Type0 and Type1 will be displayed in the screen.

- 3** Press the [OK] button to complete the setup, and adjust the position and the size of the Alarm component.

● Example of Alarm component

Use a Vector Graphics (VG0) as the rectangle background and another Vector Graphics (VG1) as the sunken display area. Use 2 Command Button components (SWD0, SWD1) to increase or decrease the starting lines of alarm information displayed (i.e. controlling the increase or decrease of the “Read Address” data). Two command button components (SWD0 and SWD1) allow the start line No. ([Read Address] of the alarm) increased or decreased to scroll the displayed alarm.



3-6-19 Data Log

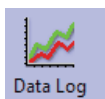

The Data Log component acquires some PLC data and displays it in the manner of a Data Log at regular intervals. When each sampling period comes to an end, new data will be read from the PLC and displayed on the right of the Data Log, which ensures the real-time display.

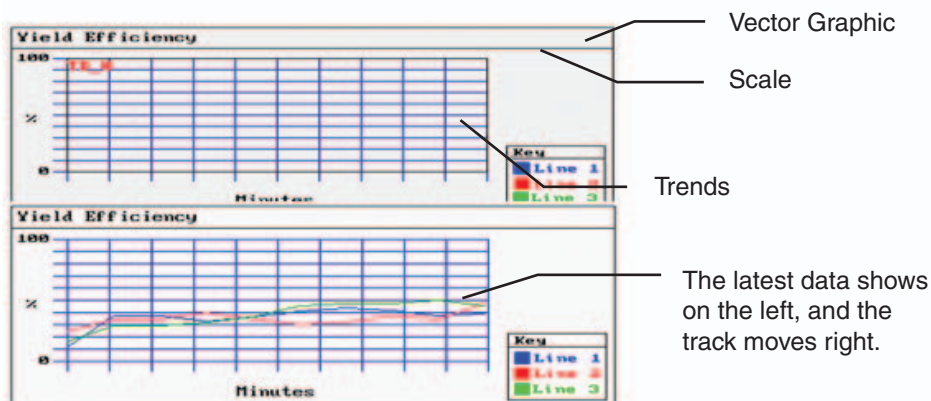

A typical example of Data Log is as above shown. Use one Vector Graphics as background, and use the Scale component to express the information on the related Data Logs. Then place the Data Log component above the Vector Graphics.

## ● Process of adding one Data Log component

- 1 Press the Data Log component icon, drag it to the screen, then the [Basic Properties] dialog box of the Data Log component will pop up.

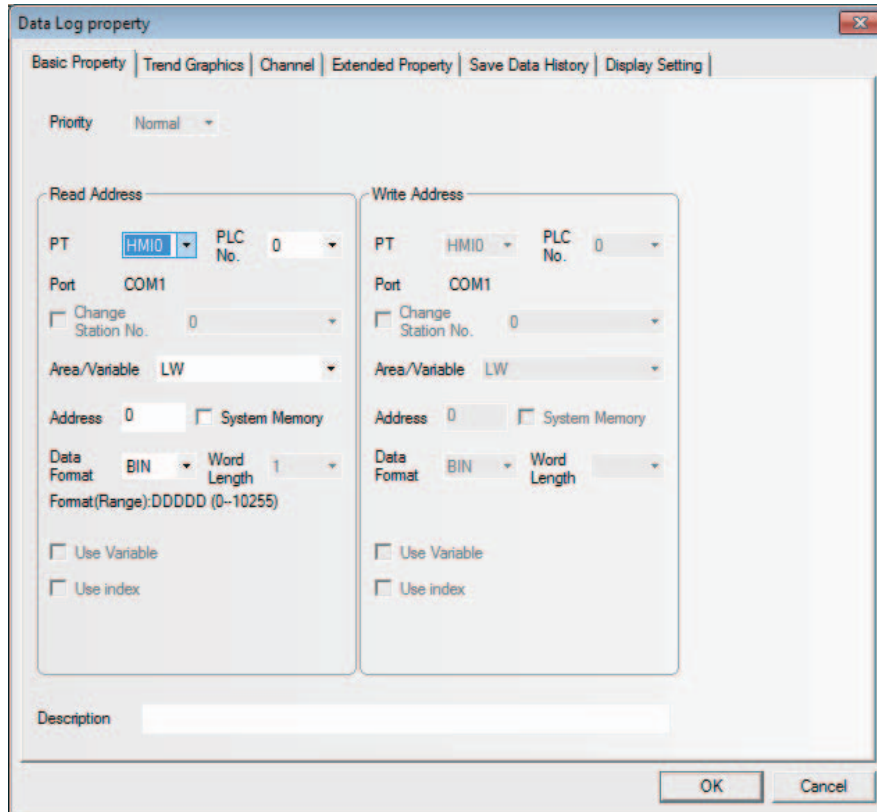

**Read Address:** Refers to the word address of PLC corresponding to the 1<sup>st</sup> line data. And the word address corresponding to the 2<sup>nd</sup> line is “Read Address + 1”, and the 3<sup>rd</sup> line is “Read Address + 2” and so on.

**Address:** Refers to the first address of the word address corresponding to the Data Log.

**Word Length:** It is determined by the sampling channels and the storage format for each channel. When the stored style of all the channel is signed 16-bit, if the channel number is N (where,  $1 \leq N \leq 16$ ), the Word Length will be N.

**2** Go to the [Trend Graphics] tab and set the parameters related to the Data Log.

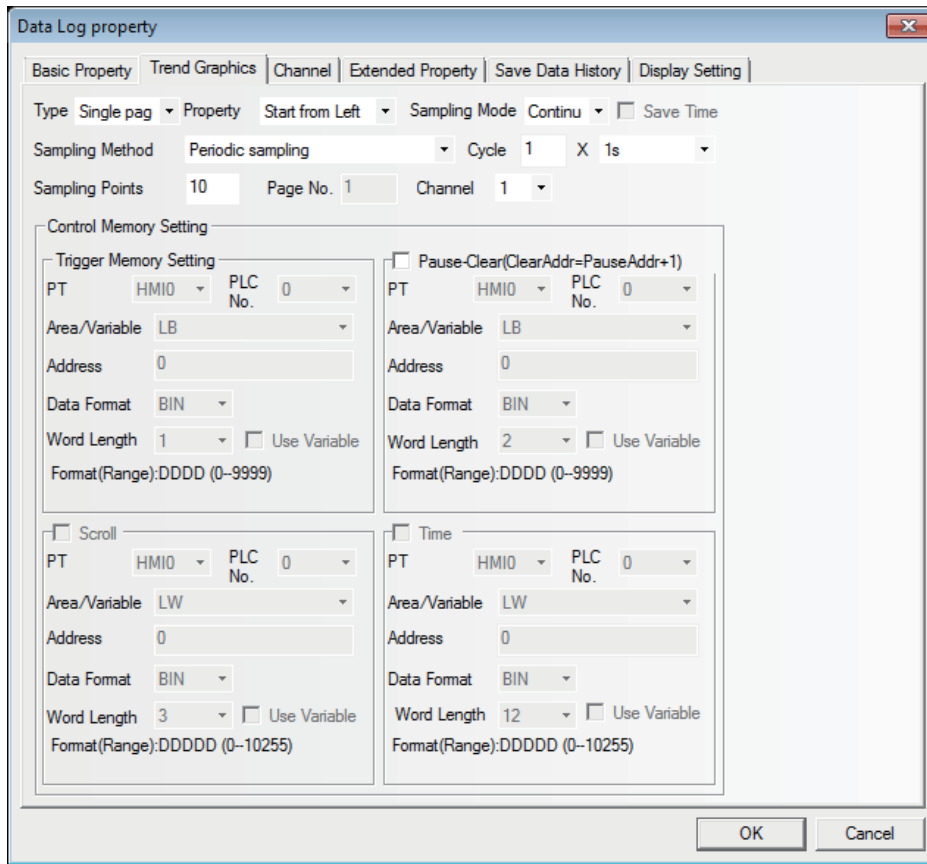

Descriptions of Data Log Properties		
Type	Single page	Only the data change information of the sampling data in the current page is displayed, and extension of Data Log is not allowed. In this style, the data which data log was updated and scrolled to be removed from the screen cannot be retained. The extension of the data log is impossible.
	Multiple pages	The extension of Data Log is possible. In this way, when the Data Log is scrolled forward, the data displayed previously will be retained. The historical data is stored in the memory for the reference in future.
Property	Start from Left	
	Start from Right	

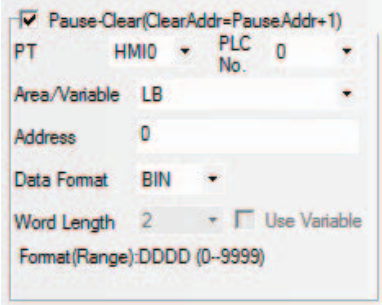
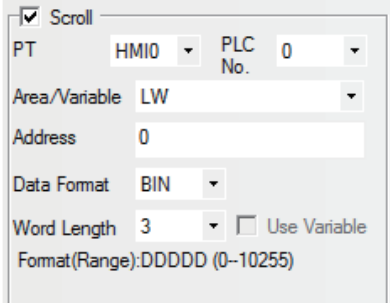
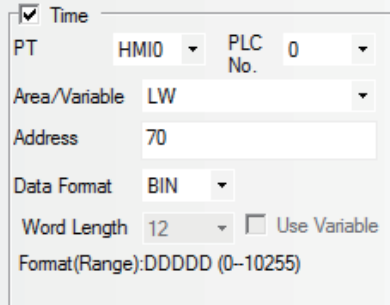

Descriptions of Data Log Properties		
Property	Start from Top	
	Start from Bottom	
Sampling Methods	Periodic sampling	The data is sampled periodically.
	OFF→ON trigger sampling	When the state of the specified bit memory address turns ON from OFF, the sampling is triggered.
	ON→OFF trigger sampling	When the state of the specified bit memory address turns OFF from ON, the sampling is triggered.
	OFF↔ON trigger sampling	When the state of the specified bit memory address changes, the sampling is triggered.
	OFF→ON reset trigger sampling	When the state of the specified bit memory address turns ON from OFF, the sampling is triggered, and the state of the specified bit memory will be set automatically to be turned OFF after the triggering.
	ON→OFF reset trigger sampling	When the state of the specified bit memory address turns OFF from ON, the sampling is triggered, and the state of the specified bit memory will be set automatically to be turned ON after the triggering.
Cycle	Setting the interval to perform sampling with the unit of “s” or “100 ms”.	
Sampling Mode	Continue	When all the sampling points end, the sampling still continues.
	Once	When all the sampling points end, the sampling will stop, which means sampling is only performed once.
Sampling Points	Refers to the number of sampling point displayed in each screen.	
Page No.	When the [Type] in the [Trend Graphics] tab is set to [Multiple pages], specify the number of page displayed.	
Channel	Refers to the number of the track line to be displayed. And the channel can be set is up to 16.	
Trigger memory Setting	<p>It is valid when “Trigger sampling” is selected as “Sampling Methods”. As the parameters are set as follows, when the state change of the specified LB100 conforms to the settings in Sampling Methods, the sampling will be triggered.</p> <div style="border: 1px solid gray; padding: 5px; width: fit-content;"> <p>Trigger Memory Setting</p> <p>PT: <input type="text" value="HM10"/> PLC No.: <input type="text" value="0"/></p> <p>Area/Variable: <input type="text" value="LB"/></p> <p>Address: <input type="text" value="100"/></p> <p>Data Format: <input type="text" value="BIN"/></p> <p>Word Length: <input type="text" value="1"/> <input type="checkbox"/> Use Variable</p> <p>Format(Range): DDDD (0-9999)</p> </div>	

Descriptions of Data Log Properties	
Pause-Clear	<p>The default Word Length is 2. "Pause" function only stops to refresh the changes in the curve temporarily, and the sampling operation will not be stopped temporarily. When "Pause-Clear" is checked as shown blow, and the state of the specified bit address LB0 is set "ON", the screen will stop refreshing temporarily When the specified bit address LB0 is set "OFF", the changes in Data Log will be refreshed and displayed.</p> <p>"Pause" stop temporarily the update of the graph so that the sampling is stopped temporarily.</p>  <p>The address can be the trigger for "Clear" is "temporarily allocated address + 1". If the parameters are specified as above, the bit address LB0 functions as "Pause" and the bit address LB1 functions as "Clear". Setting in this way, the displayed Data log screen can be cleared only the changes occurred in LB1 state.</p>
Scroll	<p>The default value is 3. For example, if the specified memory is LW0, LW0, LW1 and LW2 will be the current browsing index value (the newest data on the index value is 0 and the value is greater, the data is older.), the starting browsing index value and the maximum browsing index value of Scroll Bar respectively. This option is valid only when "Multiple pages" is selected. "Scroll" can be used to browse the multiple Data Logs and can be in combination with the Scroll Bar. For the specific using method of Scroll Bar, refer to 3-6-22 Scroll Bar (Page 3-168) in NB-Designer Operation.</p> 
Time	<p>It is used to save the time when the latest sampling point is performed. "Time" option in "Control memory Setting" is valid only when the "Save Time" is checked. The default memory is LW and the Word Length is 12.</p>  <p>As shown above, when the specified address is LW70, each data is stored as below:</p> <ul style="list-style-type: none"> <li>• The sampling time of the oldest data within the displayed page Second: LW70, Minute: LW71, Hour: LW72, Day: LW73, Month: LW74, Year: LW75</li> <li>• The sampling time of the newest data within the displayed page Second: LW76, Minute: LW77, Hour: LW78, Day: LW79, Month: LW80, Year: LW81</li> </ul>

**Note** When the trigger sampling is used, if multiple samplings are performed at the same timing, only single value might be acquired.  
When such a state is assumed, place the Data Transmission component and others on the Common Sheet and acquire the necessary data at local memory to perform the sampling for the local memory.

- 3** Switch to the [Channel] tab and set the parameters related to each track line.

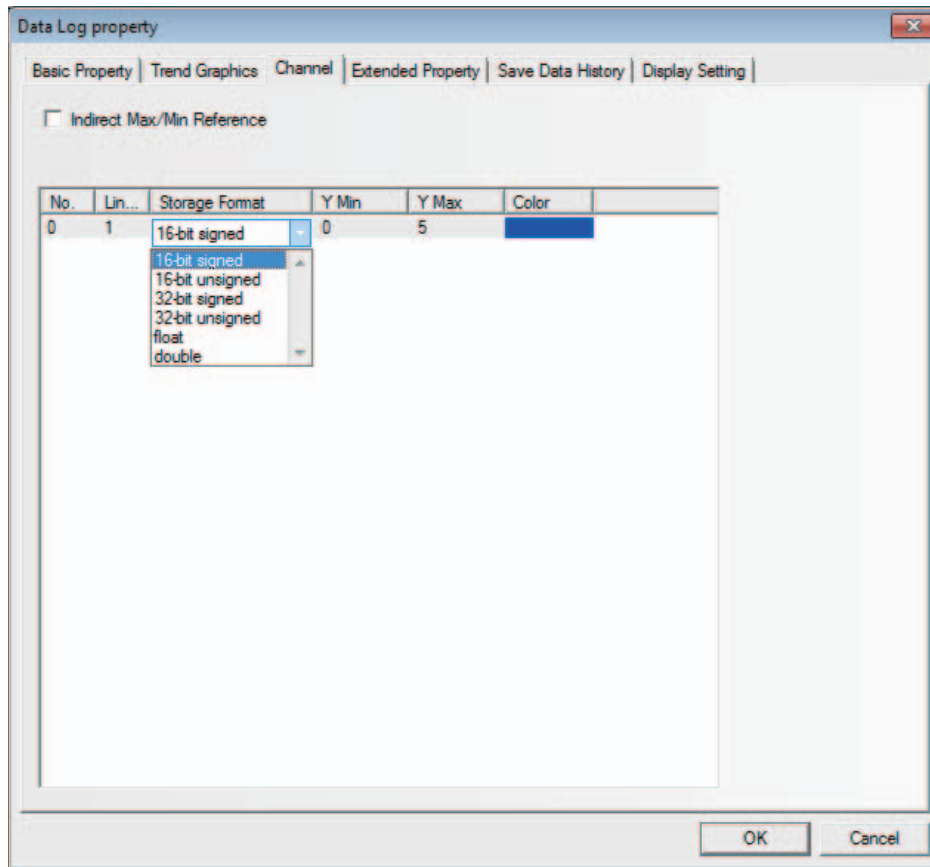

**Color:** Specifies the color for each track line.

**Line Width:** Refers to the thickness of the line, and 8 kinds of line width are available here.

**Storage Format:** Sets the data type used by the user and 6 kinds are available.

**Y Min/Y Max:** Sets the minimum value and maximum value of the data corresponding to each track line in Y direction.

**Indirect Max/Min Reference:** Sets the display range of channel track to variable, and specifies the memory address for reading range value. For the multiple channels, the memory can be specified independently, and [The Specified Indirect memory Address] is Y Min, and [The Specified Indirect memory Address + 1] is Y Max.

- 4** Switch to the [Save Data History] tab and determine whether to check “Save to Recipe Data Field”.

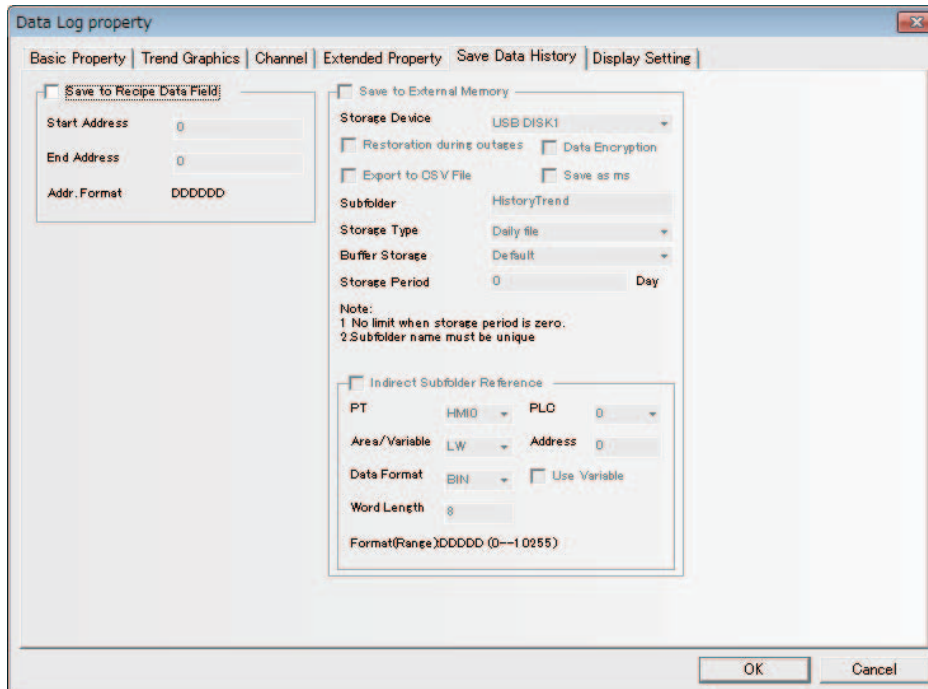

**Save to Recipe Data Field:** After this option is checked and the Start Address. is set, the sampling data can be saved to the Recipe Data Field(RW).

Data History for the Data Log is saved in the [Start Address] as the top, and the memory area includes the Information Area with the size of 40 bytes (i.e. 20 words), and the Time Area with the size of Sampling Pages × Sampling Points/Page × 4 words and the Data Area with the size of Sampling Pages × Sampling Points/Page × Word Length.

When the multiple historical Data Logs saved into the recipe are used, the user must ensure that the memory area of each trend curves will not overlap each other, otherwise, the data mistakes will occur.

- 5** Press the [OK] button to adjust the position and size of the Data Log component.

● Indirect Max/Min Reference of Data Log

Descriptions: LW0 represents the variable making sampling for the Y coordinate, and the horizontal axis represents the Time Axis. And LW1 and LW2 correspond to the minimum value (lower limit of Y) and the maximum value (upper limit of Y) respectively.

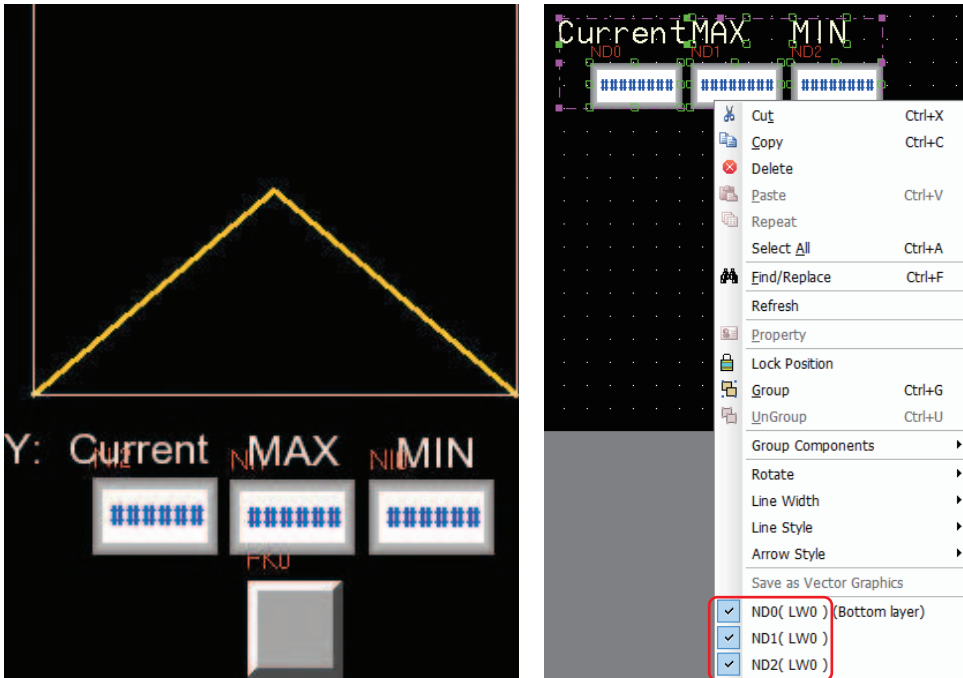

3-6 Parts  
3  
3-6-19 Data Log

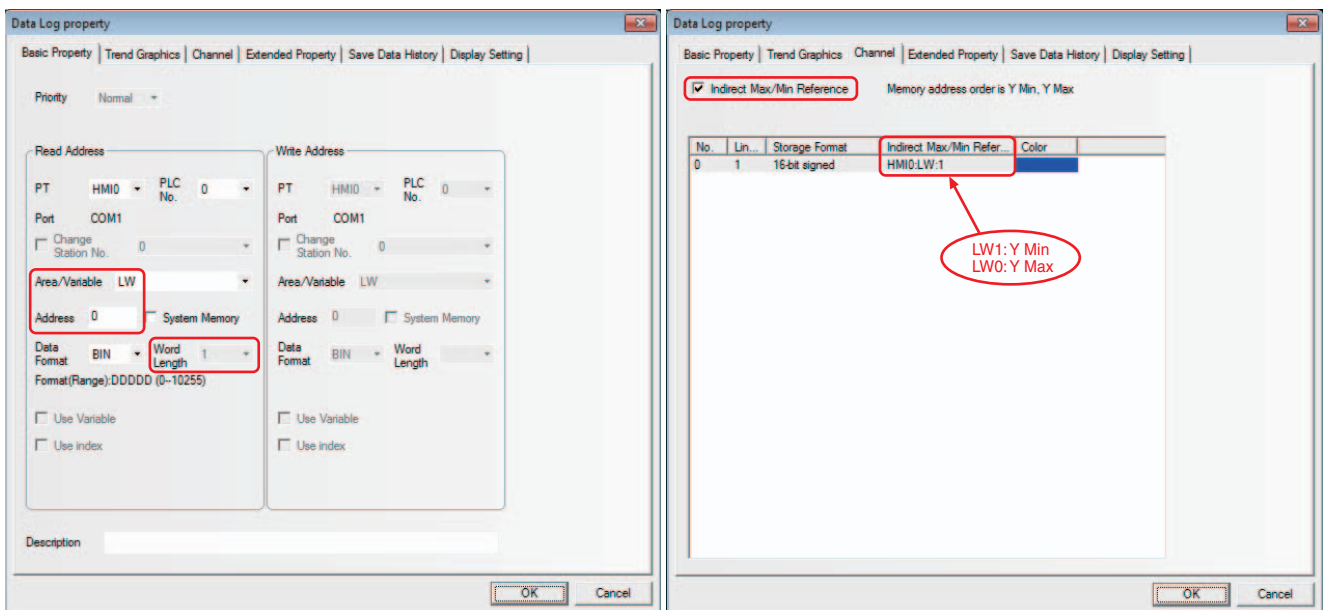

● **Checking and Zooming Functions**

The zooming function can be enabled or disabled by the special system memory LB9110, i.e. the zooming function will be valid when the LB9110 is turned ON and invalid when the LB9110 is turned OFF. In order to use this function, it is necessary to set the [Type] option to “Multiple pages” and [PageNum] option to more than 1 in the [Trend Graphics] tab respectively. With the LB9110 being turned ON, zoom-out status of the curve can be checked only by double clicking on the Data Log, and the zoom-in status of selected curve can be checked by clicking at the start point of the curve and loosening it after dragging it to the end point of the curve.

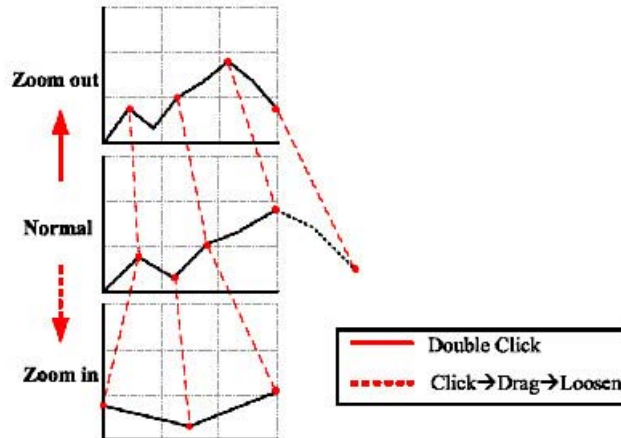

● **Query of Sampling Time**

When LW9200 to LW9205 are used to store the time for sampling points, the user can place the Number Display components corresponding to these addresses to display the time for sampling points. Procedures:

- 1 Checking the [Save Time] option and [Time] check boxes ( Note this is not the sampled time) in the [Trend Graphics] tab in the [Data Log Property] dialog box:  
The [Time] option can be used to set the first address for saving the time, which covers 12-word-length address for saving the starting time of the Data Log (the former 6 words) and the time value of the current Data Log (the latter 6 words) in “ssmmhddmmyyy” format and BIN Data Format respectively.

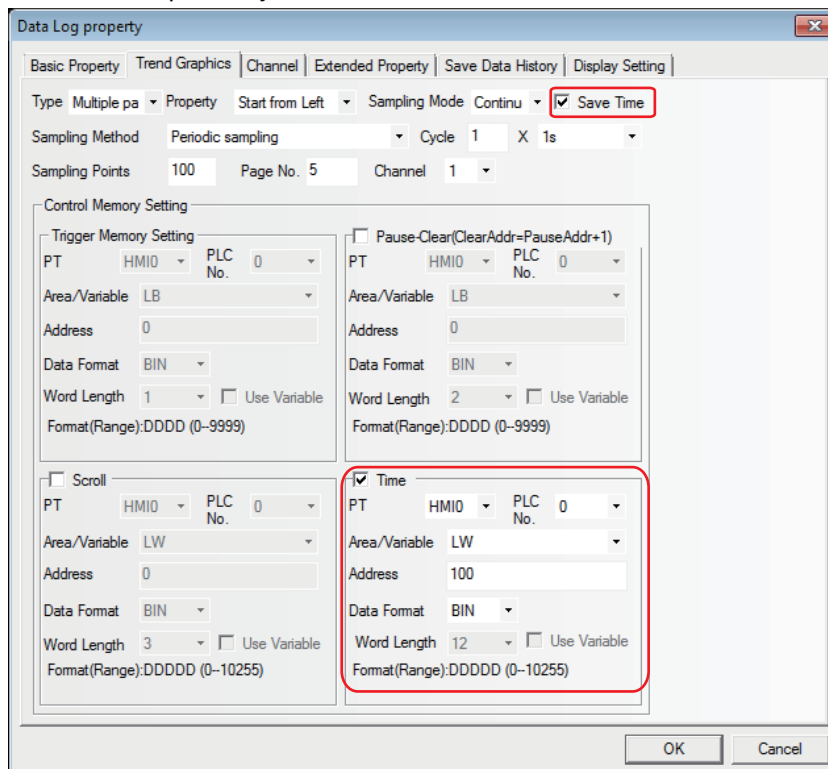

**2** The function of query of sampling time is only enabled by LB9110 when the zooming function is used. And when the LB9110 is turned ON, the zooming and checking functions can be activated. When the above functions are enabled, even if the sampling is performed, the user can choose the sampling point(s) in the real-time Data Log directly, and the time for sampling point will be stored to LW9200 to LW9205 at this time. And the time query is also available with the sampling point(s) from the Data Log being selected after the zooming in of one selected section.

Description list of related addresses:

memory Address	Descriptions	Addr. Type
LB9110	Control bit of zooming function	Bit address
LW9200	Second	Word address
LW9201	Minute	Word address
LW9202	Hour	Word address
LW9203	Day	Word address
LW9204	Month	Word address
LW9205	Year	Word address

● **Query of sampling point value**

Addresses of Special memories	Function	Descriptions
LW9210~ LW9210+N	Displays values of each channel of browsed points.	N represents the channel number, and the sampling value of browsed points for each channel is stored. For example, if the channel number is 2, the sampling value of current browsed points for channel 1 will be stored to LW9210, and that for channel 2 will be stored to LW9211.

● **Example of checking the operation result of sampling point information**

The following shows the checking of sampling point information after the Data Log with 2-channel data is zoomed in:

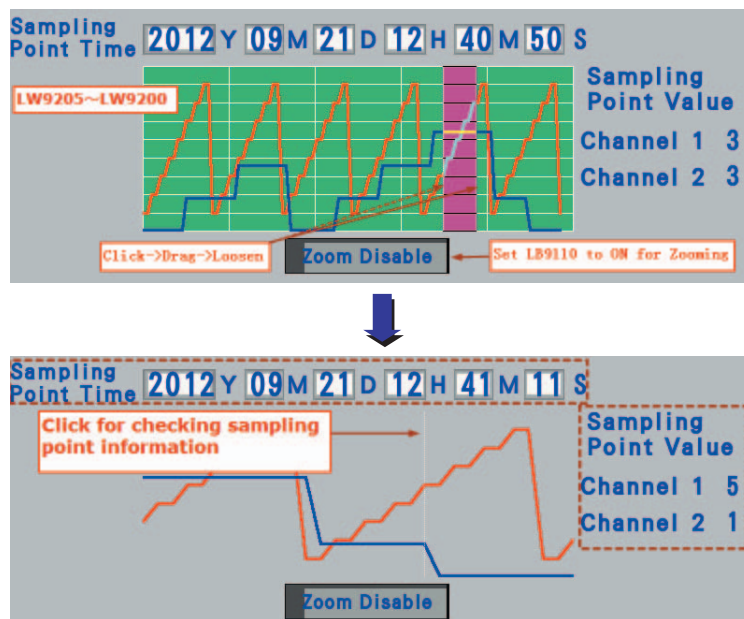

### 3-6-20 Recipe



Recipe component can realize the data transmission from the recipe memory of PT to PLC, or vice versa. For details, refer to *3-12 Recipe Data (Page 3-342)* in *NB-Designer Operation*.

### 3-6-21 Oscilloscope



The Oscilloscope functions similarly to the Data Log, and the difference between them is as follows: For the Data Log, the background communication still continues to do when the current screen where the Data Log locates is closed, the sampling information before the switching can be obtained when the Data Log is switched to at any time. But the data sampling of the Oscilloscope is valid only in the current page, which means the Oscilloscope data will not be read but be lost each time when the page is switched, and the data sampling will start from the beginning when the Oscilloscope screen is switched to. The advantages of Oscilloscope are as follows: The user can monitor several waveforms that don't need to be recorded for the long period, and no background communication burden will be brought. Meanwhile, the user can use the "Sampling Rate" function provided by the Oscilloscope, the combination with the PLC allows to change the frequency of sampling point instead of only being limited on the frequency of 1s/sampling point.

#### ● Process of adding one Oscilloscope component

- 1 Press the Oscilloscope component icon, drag it to the screen, then the [Basic Properties] dialog box of the Oscilloscope component will pop up.

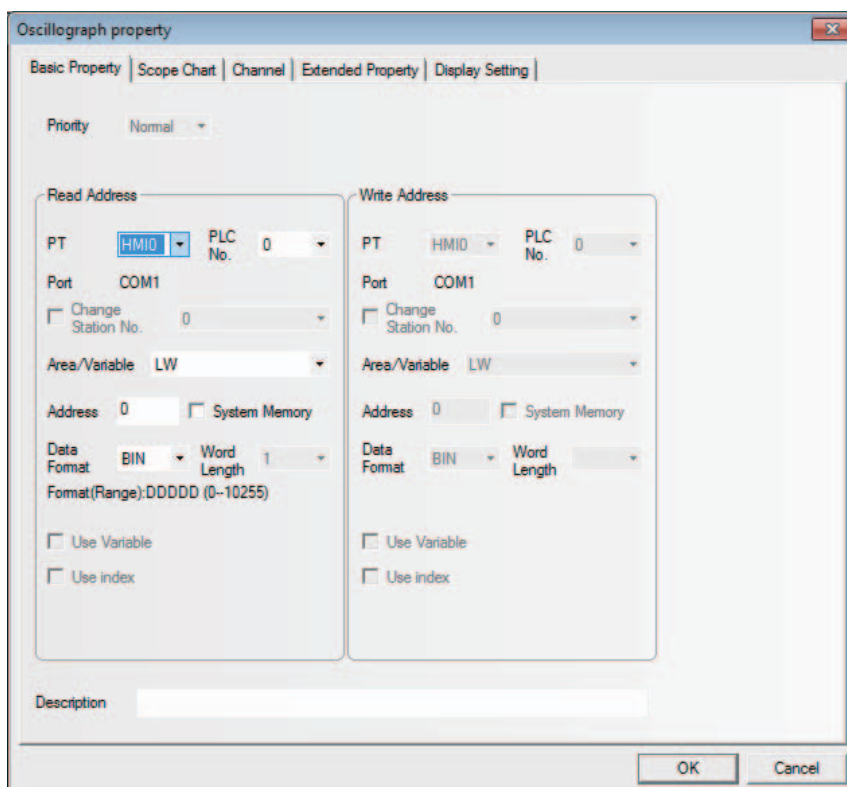



**Read Address:** Refers to the word address of PLC corresponding to the 1<sup>st</sup> graph. And the word address corresponding to the 2<sup>nd</sup> graph is “Read Address + 1”, and the 3<sup>rd</sup> graph is “Read Address + 2” and so on.

**Address:** Refers to the first address of the word address corresponding to the graph.

**Word Length:** It is determined by the sampling channels. If the channel number is N (where,  $1 \leq N \leq 16$ ), the Word Length will be N.

**2** Go to the [Scope Chart] tab and set the parameters related to the Oscilloscope component.

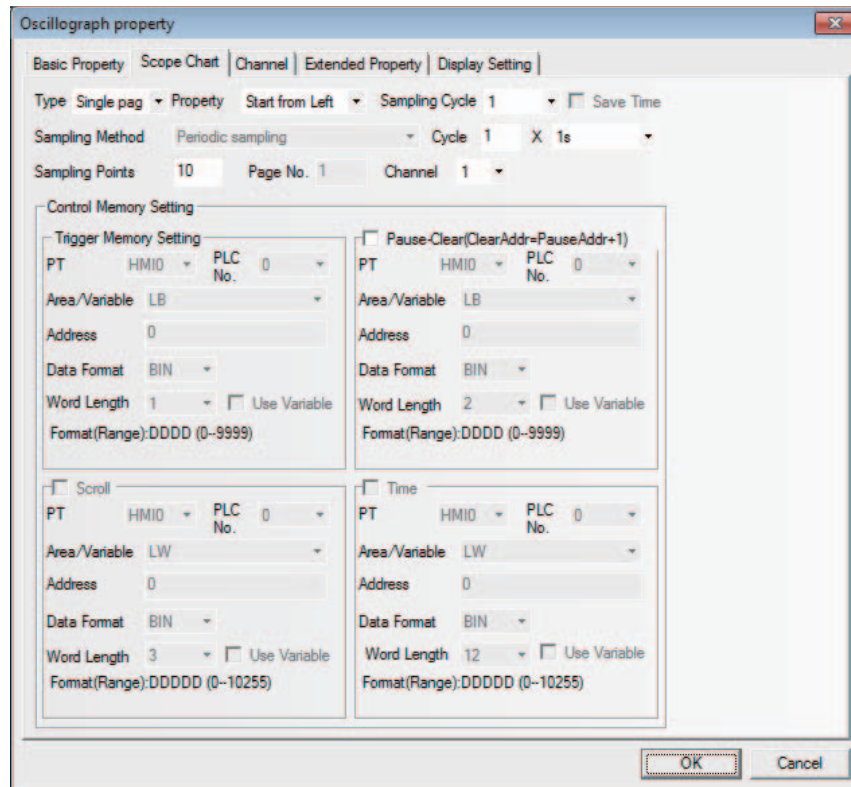

**Descriptions of Scope Chart**

Type	Single page	Only the data change information of the sampling data in the current page is displayed. In this type, the data which was scrolled and removed from the screen will not be retained.
	Multiple pages	The extension of Data Log is allowable. In this type, even if the Oscilloscope is scrolled, the data displayed before the scrolling will be retained.
Property	Refers to the start movement direction of Oscilloscope track.	
Cycle	Refers to the interval to perform sampling with the unit of “s” or “100 ms”.	
Sampling Rate	When the Sampling Rate is selected, the Oscilloscope component will read the group data with the sampling rate and display them at a time. For example, when the Read Address is LW10, Sampling Rate is 2 and channel is 3, the values stored to the memory from LW10 to LW15 for each sampling rate can be read. And the assignment is as follows: two of the data is read for each sampling. The values will be read in the order of LW10, LW13 for channel 1, LW11, LW13 for channel 2, LW12, LW15 for channel 3. When the sampling time is 1 s, the above-mentioned two group data will be read each second. And when the sampling rate is used, the chart is more accurate and smooth.	
Sampling Points	Refers to the number of sampling point displayed in each screen.	
Page No.	This option is valid only when “Multiple pages” is selected.	
Channel	Refers to the number of the graph to be displayed (16 channels at max.).	

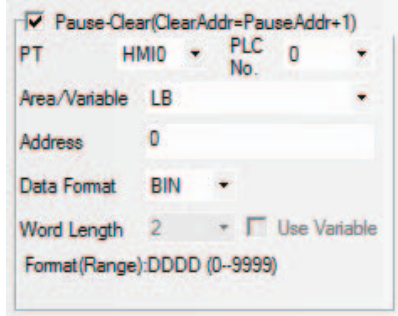
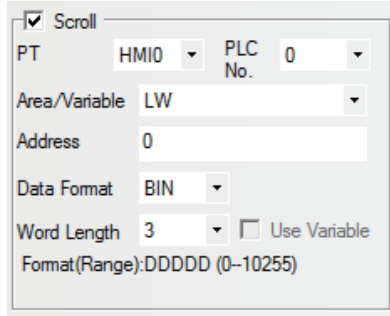
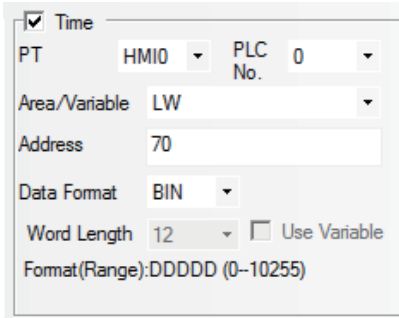
Descriptions of Scope Chart	
Pause-Clear	<p>The default Word Length is 2. "Pause" function stops temporarily the refresh of the graph and the sampling operation will not be stopped temporarily. When "Pause-Clear" is checked as shown below, and the state of the specified bit address LB0 is set "ON", the screen will stop refreshing temporarily. When the specified bit address LB0 is set "OFF", the graph will be refreshed and displayed.</p>  <p>"Clear" corresponds to the "address allocated temporarily to Pause + 1". Specifying the parameters as above, the bit address LB0 functions as "Pause" and the bit address LB1 functions as "Clear". Displayed graph can be cleared only the changes occurred in LB1 state.</p>
Scroll	<p>The default value is 3. For example, if the specified memory is LW0, LW0, LW1 and LW2 will be the current browsing index value (the newest index value is 0 and the value is greater, the data is older), the starting browsing index value and the maximum browsing index value of Scroll Bar respectively. This option is valid only when "Multiple pages" is selected. "Scroll" can be used to browse the multiple graph and can be in combination with the Scroll Bar. For the specific using method of Scroll Bar, refer to 3-6-22 Scroll Bar (Page 3-168) in NB-Designer Operation.</p> 
Time	<p>It is used to save the time when the latest sampling point is performed. "Time" option in "Control memory Setting" is valid only when the "Save Time" is checked. The default memory is LW and the Word Length is 12.</p>  <p>As shown as above, when the allocated address is specified to LW70, each data is stored as below:</p> <ul style="list-style-type: none"> <li>• The sampling time of the oldest data within the displayed page Second: LW70, Minute: LW71, Hour: LW72, Day: LW73, Month: LW74, Year: LW75</li> <li>• The sampling time of the newest data within the displayed page Second: LW76, Minute: LW77, Hour: LW78, Day: LW79, Month: LW80, Year: LW81</li> </ul>

**Note** When the trigger sampling is used, if multiple samplings are performed at the same timing, only single value might be acquired.

When such a state is assumed, place the Data Transmission component and others on the Common Sheet and acquire the necessary data at local memory to perform the sampling for the local memory.

- 3** Switch to the [Channel] tab and set the parameters related to each graph.

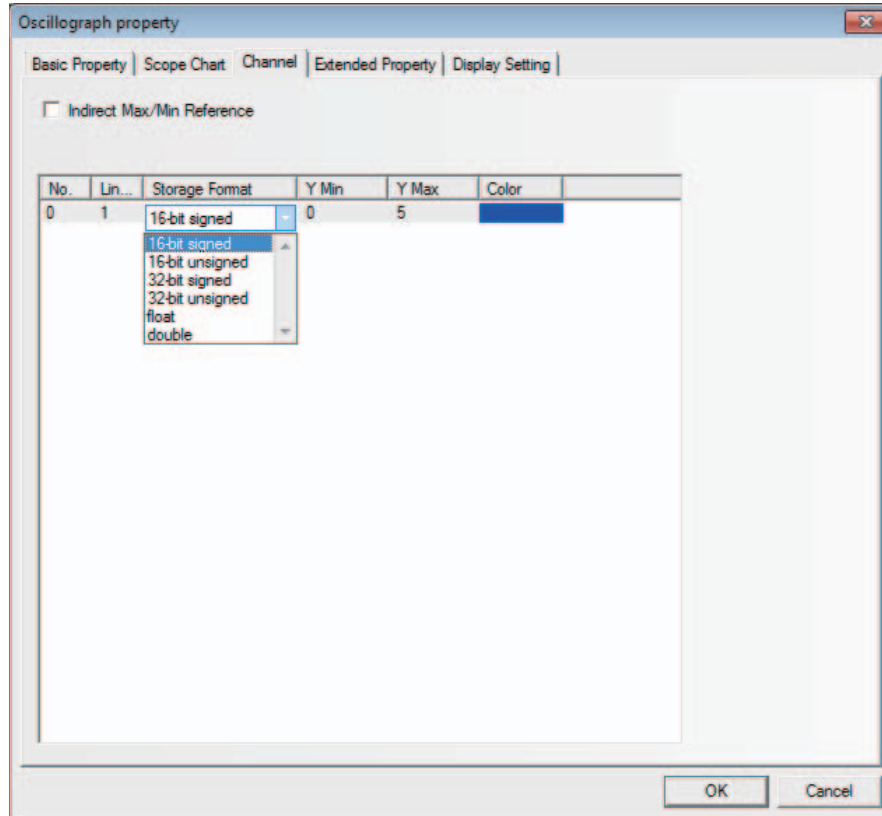

**Color:** Specifies the color for each track line.

**Line Width:** Refers to the thickness of the line, and 8 kinds of line width are available here.

**Storage Format:** Sets the data type used by the user and 6 kinds are available.

**Y Min/Y Max:** Sets the minimum value and maximum value of the data corresponding to each track line in Y direction.

**Indirect Max/Min Reference:** Sets the display range of channel track to variable, and specifies the memory address for reading range value. For the multiple channels, the memory can be specified independently, and [The Specified Indirect memory Address] is Y Min, and [The Specified Indirect memory Address + 1] is Y Max.

- 4** Press the [OK] button, and then adjust the position and size of the Oscilloscope component.

## 3-6-22 Scroll Bar



Scroll Bar is used to change the value in the specified word memory by pressing the slider.

### ● Process of adding one Scroll Bar component

- 1 Press the Scroll Bar component icon, drag it to the screen, then the [Basic Properties] dialog box of the Scroll Bar component will pop up.

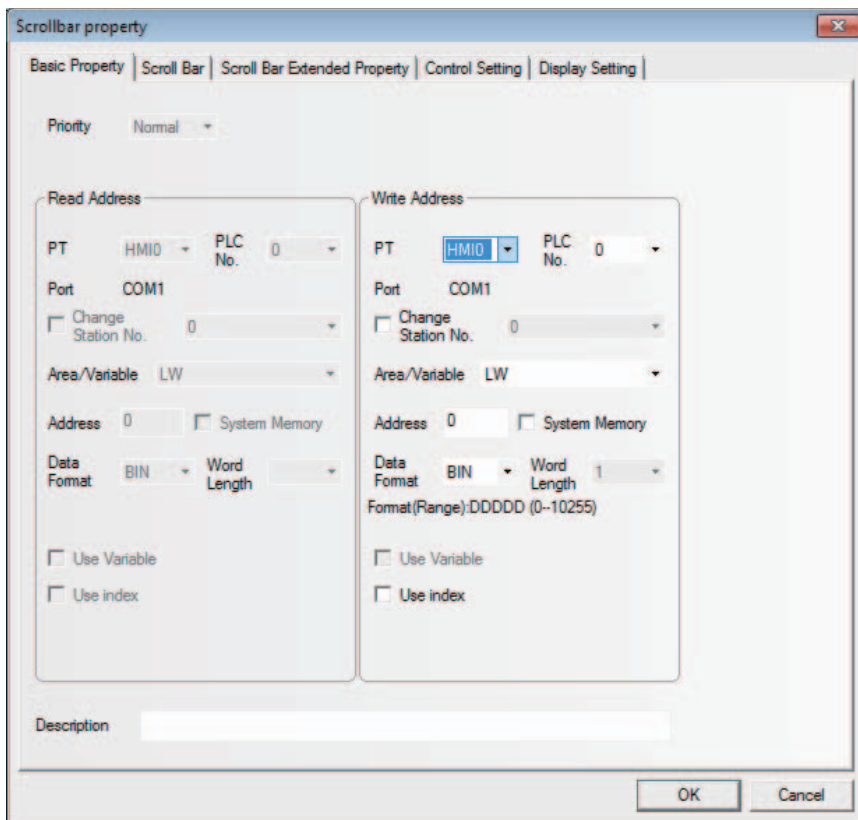

**Write Address:** Refers to the address of word memory of the current browsing index value for the Scroll Bar component.

**Address:** Refers to the first address of the word address corresponding to Scroll Bar.

**Word Length:** Displays the data length of the write address, which is 1 by default.

## 2 Go to the [Scroll Bar] tab.

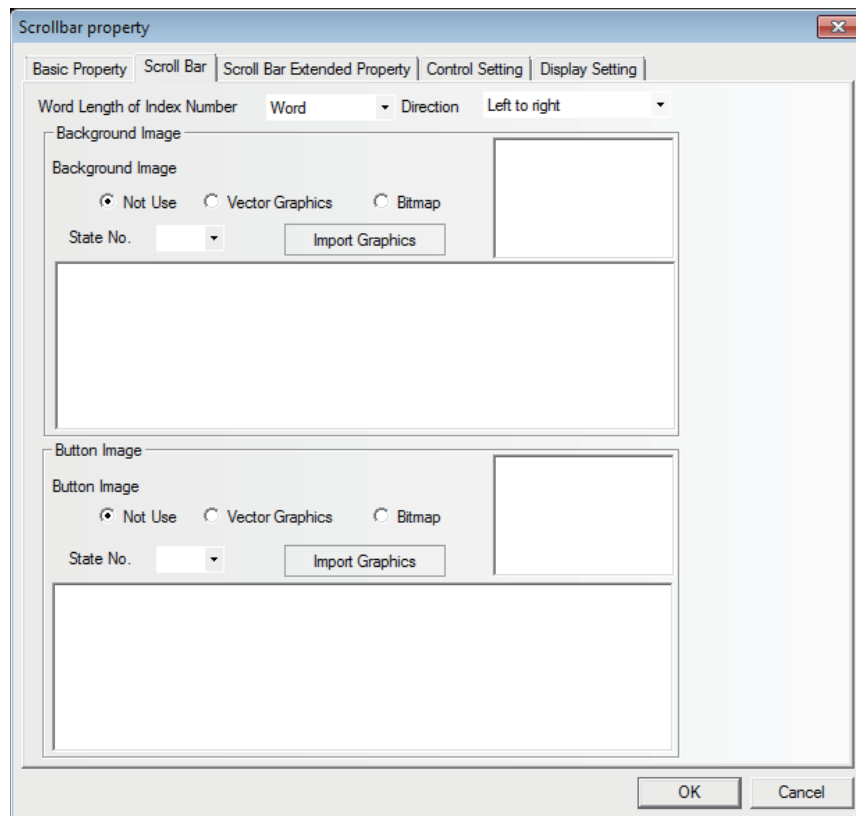

**Word Length of Index Number:** Word and double-word are available.

**Direction:** Refers to the moving direction of the Scroll Bar, and it includes “Left To Right”, “Right To Left”, “Up To Down” and “Down To Up”.

**Background Image:** Refers to the background images used by the Scroll Bar. It includes “Not Used”, “Vector Graphics” and “Bitmap”. If “Vector Graphics” or “Bitmap” is selected, you can select the Vector Graphics or bitmap you want to use in “Image”, and you can also select the State Number corresponding to the Vector Graphics or bitmap mentioned above.

**Button Image:** Refers to the button images used by the Scroll Bar. It includes “Not Used”, “Vector Graphics” and “Bitmap”. If “Vector Graphics” or “Bitmap” is selected, you can select the Vector Graphics or bitmap you want to use in “Image”, and you can also select the State Number corresponding to the Vector Graphics or bitmap mentioned above.

- 3** Go to the [Scroll Bar Extended Properties] tab and set the Slider Width and Indirect Max/Min Reference.

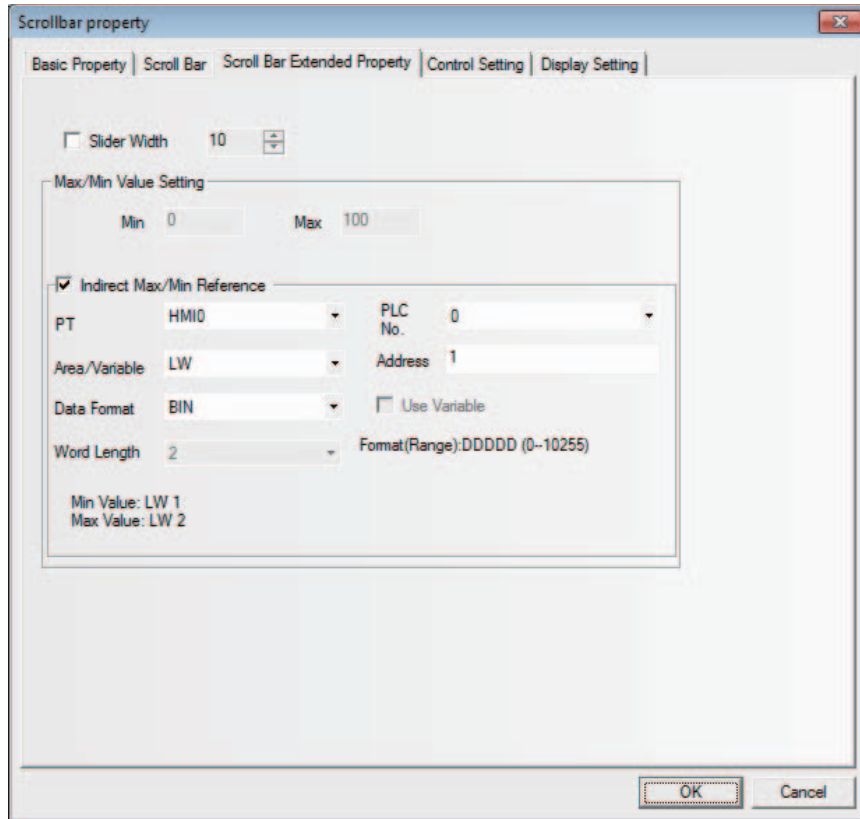

**Slider Width:** Checking it means the slider width will be set by manual, and Not-checking it means the slider width is 10 pixels by default.



**Max/Min Value Setting:**

**Min:** The lower limit of the Scroll Bar component is the starting browsing index value. (-2147483648 to 2147483647 available)

**Max:** The upper limit of the Scroll Bar component is the maximum browsing index value. (-2147483648 to 2147483647 available)

**Indirect Max/Min Reference:** Checking it means the starting browsing index value and the maximum browsing index value of the Scroll Bar use the variables.

Assuming the address of the index memory is LW1, the addresses of the starting browsing index value and the maximum browsing index value will be LW1 and LW2 respectively.

- 4** Press the [OK] button to complete the setup, and adjust the position and size of the Scroll Bar component.

### 3-6-23 Event

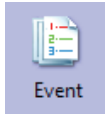

Event component is used to display the event information registered in “Event Setting” and whose current state satisfying the triggering conditions. The Event component will display triggered event information one by one according to the time sequence of the triggered event. If the accurate time needs to be displayed, the Time must be read from the PLC.

If multiple events are triggered, the events will be displayed in the order of descending or the latest event will be at the top and the oldest event at the bottom.

In addition, if 1024 events or more are triggered, the event will be deleted in order from the oldest event. When only a particular event is displayed, there may be the cases where the event suddenly disappears because of the hidden events of which the number has significantly increased to exceed 1024.

#### ● Process of adding one Event component

- 1 Press the Event component icon, drag it to the screen, then the [Basic Properties] dialog box of the Event component will pop up.

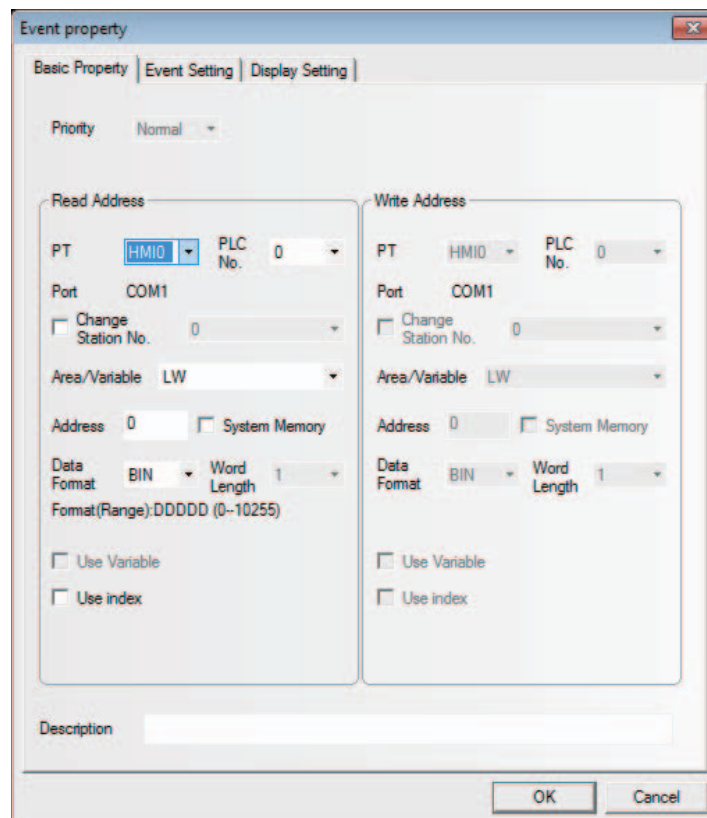

**Read Address:** Refers to the address controlling the scroll of the event display. All the information is classified according to the triggered time of the event, and the new event is displayed on the top while the old event is displayed on the bottom. For example, the value of the read address is N, the Nth event will be displayed on the first line and the events on the lines with the smaller No. than Nth line will be removed in the screen.

**Address:** Refers to the word address to support the controlling the scroll.

**Word Length:** Displaying the word length of read address (fixed as 1).

## 2 Go to the [Event Information] tab.

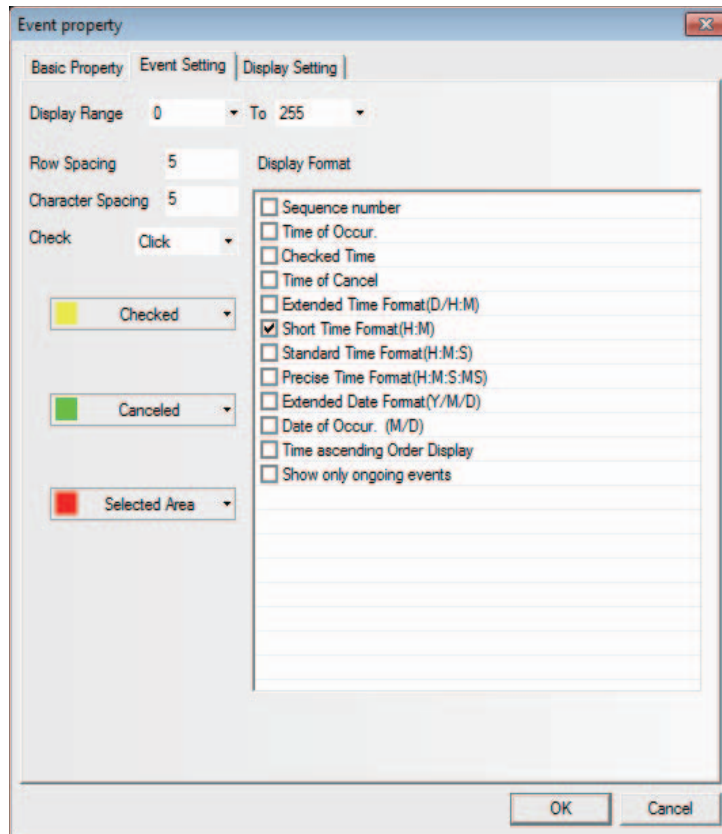

**Row Spacing and Character Spacing:** Refers to the distances between two neighboring lines and characters. Graphic font ignores this setting.

**Check:** Includes the [Click] or [Double click].

**Checked:** Refers to the color after the event is confirmed.

**Canceled:** Refers to the color after the event is released.

**Select Area:** Indicates the color of the dotted line representing the selected area.

**Display:** Refers to the format of the Event Information Display. All the added contents (such as Sequence No. and Event Trigger Time) are displayed in the front of the event information.

Format Content	Descriptions
Sequence Number	Refers to the Event No. beginning from 0.
Time of Occur	The time when the event is triggered.
Checked Time	The time when the event is confirmed.
Time of Cancel	The time when the event is released. (i.e. returns to normal).
Extended Time Format	The time format is displayed as Day/Hour: Minute.
Short Time Format	The time format is displayed as Hour: Minute.
Standard Time Format	The time format is displayed as Hour: Minute: Second.
Precise Time Format	The time format is displayed as Hour: Minute: Second: Millisecond.
Extended Date Format	The data format is displayed as Year/Month/Date.



Format Content	Descriptions
Date of Occur	The data format is displayed as Month/Date.
Time ascending Order Display	The event is displayed in the ascending order.
Show only ongoing events	Only the event that is triggered is displayed here. And the released event will not be displayed in the Event list. If this option isn't checked, the events occurred before but return to normal will still be displayed in the event list unless the event list is cleared.

No.	Date of Occur.	Time of Occur.	Checked Time	Time of Cancel	Event content
3	2011/06/01	13:47:24	13:47:30	13:47:26	Abnormal Pressure!
2	2011/06/01	13:47:20	13:47:26	13:47:30	Abnormal Temp.!
1	2011/06/01	13:47:14	13:47:27	13:47:18	Abnormal Pressure!
0	2011/06/01	13:47:11	13:47:27	13:47:16	Abnormal Temp.!

**Time ascending Order Display:** When this option is checked, the latest occurred event will be displayed on the bottom and the event sequence No. and the time will ascend from top to bottom, as shown below.

Ascending order by time, new trigger events are displayed on the following.	0	14:12	Alarm 1
	1	14:13	Alarm 1
	2	14:14	Alarm 1
	3	14:15	Alarm 1

When this option is not checked, the event will be displayed in the descending order, i.e. the latest occurred event will be displayed on the top, and event sequence No. and the time will descend from top to bottom, as shown below.

Descending order by time, new trigger events are displayed on the top.	3	14:06	Alarm 1
	2	14:05	Alarm 1
	1	14:04	Alarm 1
	0	14:03	Alarm 1

- 3 Press the [OK] button to complete the setup, and adjust the position and the size of the Event component.

● Example of Event

- 1 First create a new project and [Save] it.
- 2 Add two events in the [Event Setting], as shown below.

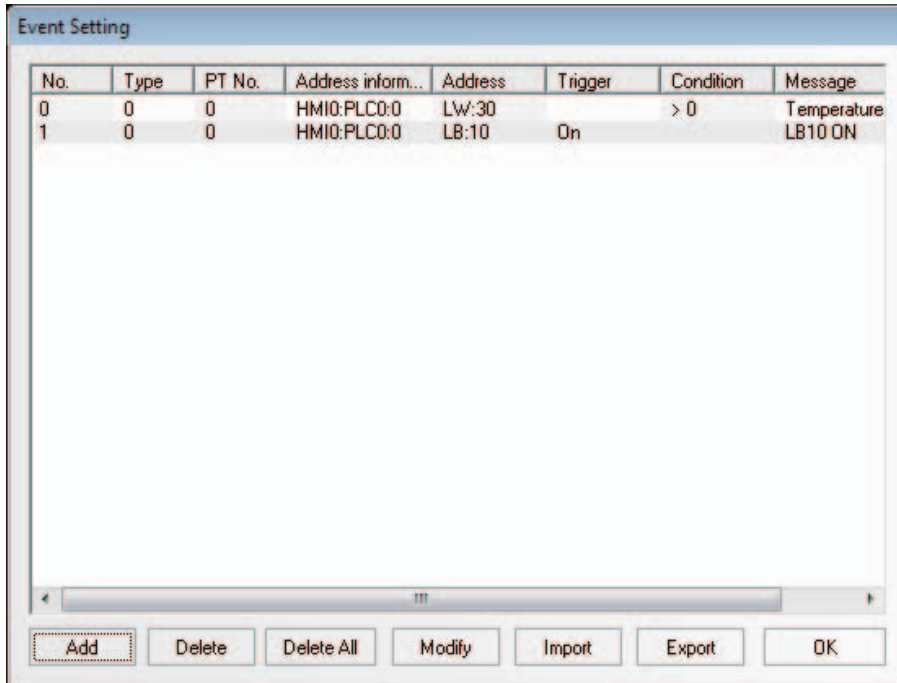

Where, the 1<sup>st</sup> event is the pop-up screen 4 and the 2<sup>nd</sup> event is the pop-up screen 5.

- 3 Add one Indirect Screen in screen 0 of the newly created project and its [Read address] of LW5.
- 4 Add one Event component in screen 0, as shown below.

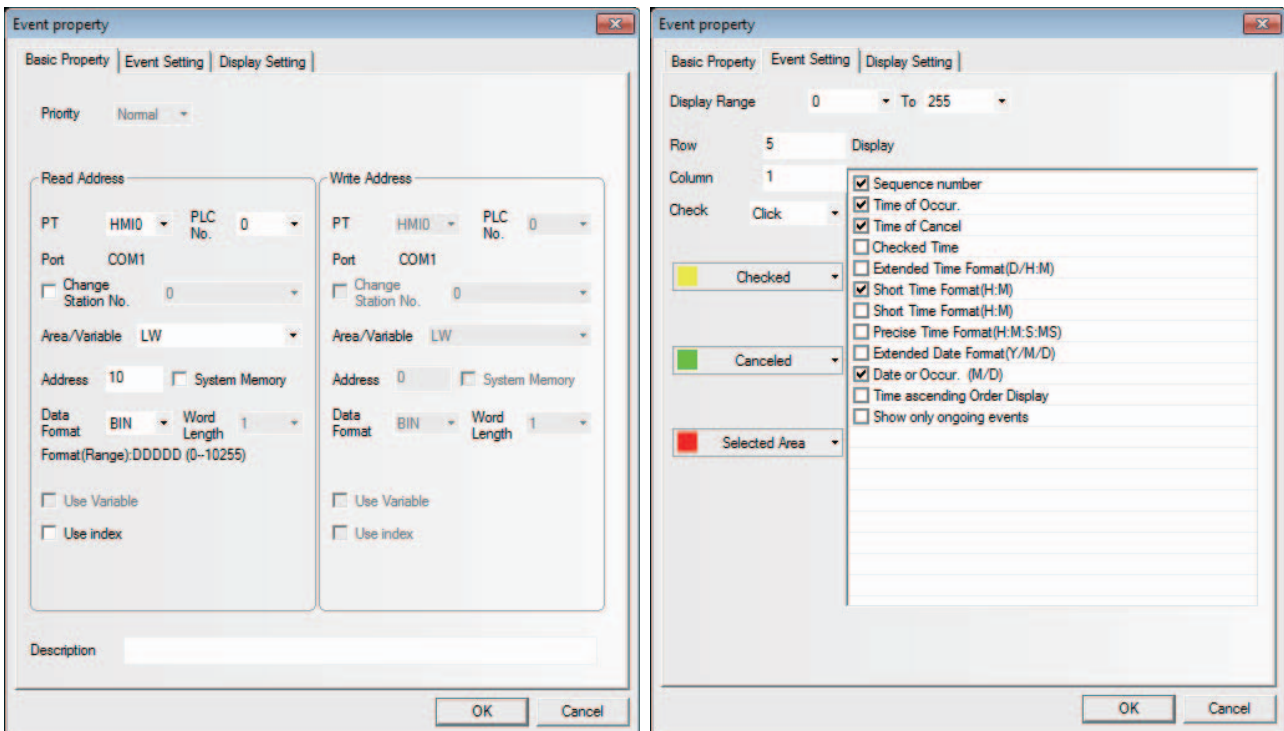

Place one Vector Graphics under the Event component to enhance the display effect.

- 5 Add one Bit Switch to control the ON/OFF state of LB10.
- 6 Add one Text component with the content of “Increase water temperature”.
- 7 Add one Command Button component with the settings as shown below:

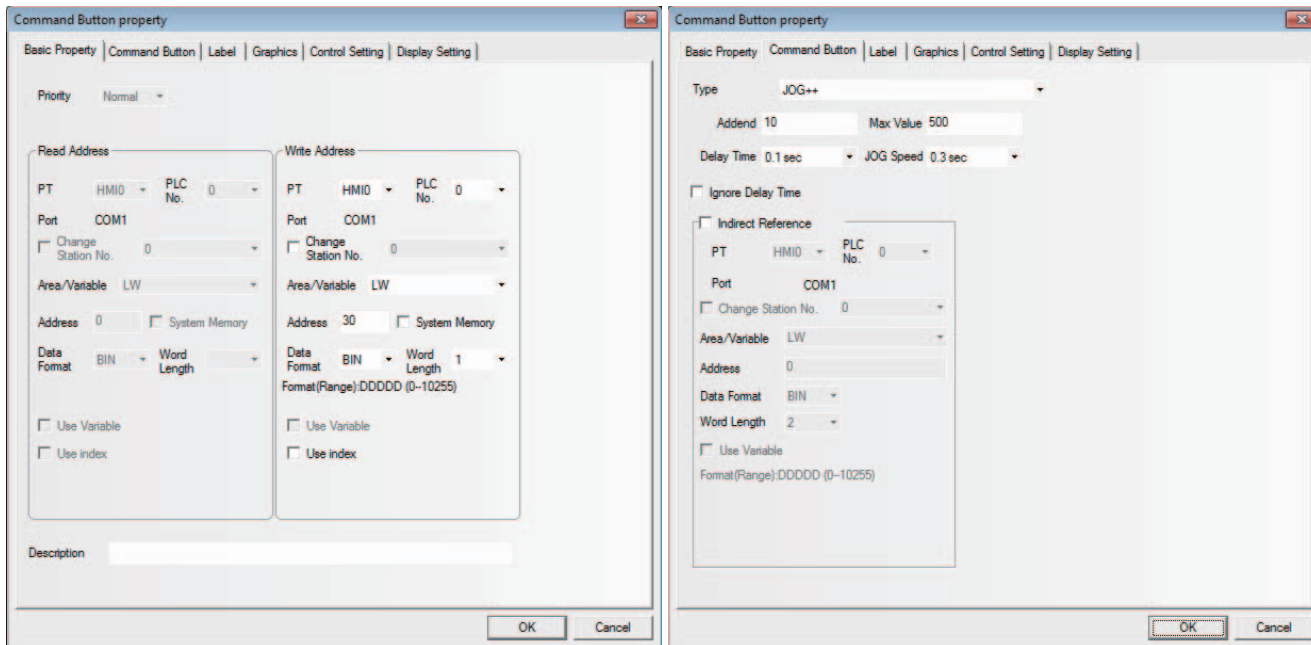

Finally, the screen 0 is shown as below:

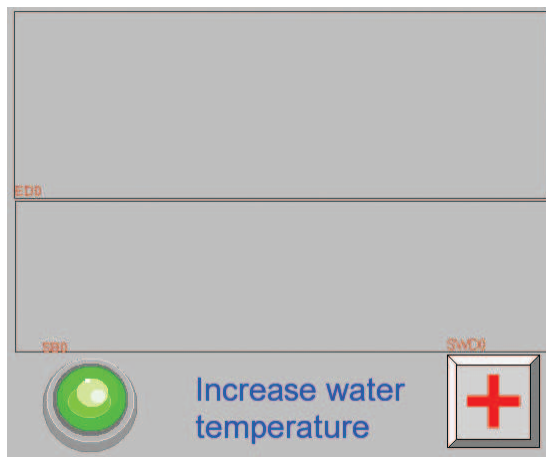

- 8** Create screen 4 with one Text component and one Bit Switch component controlling the LB10, as shown below.

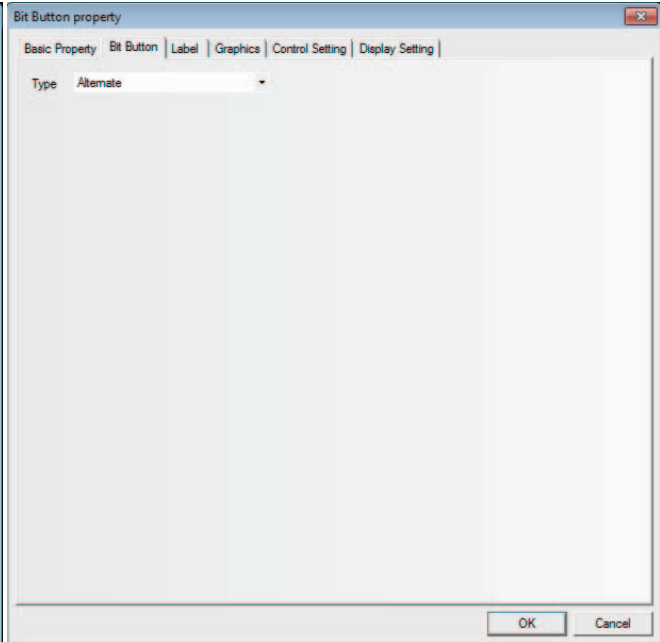
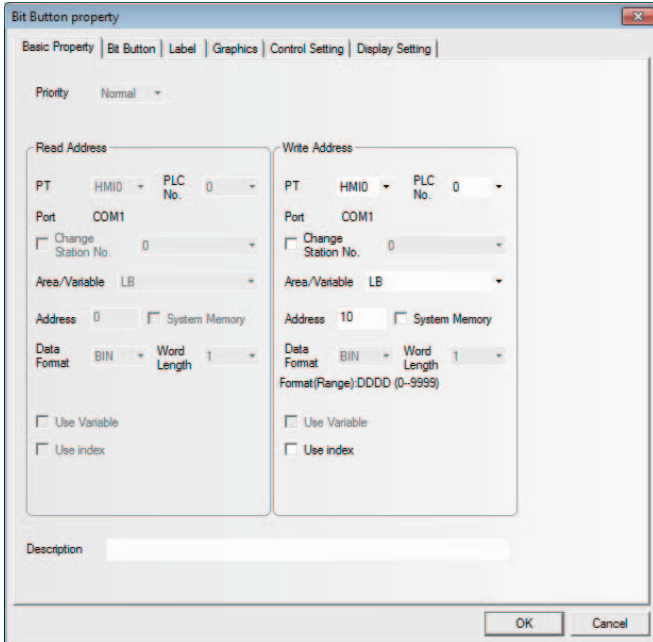
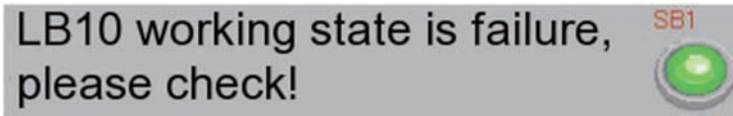

- 9** Create screen 5 with one Text component and one Command Button component, as shown below.

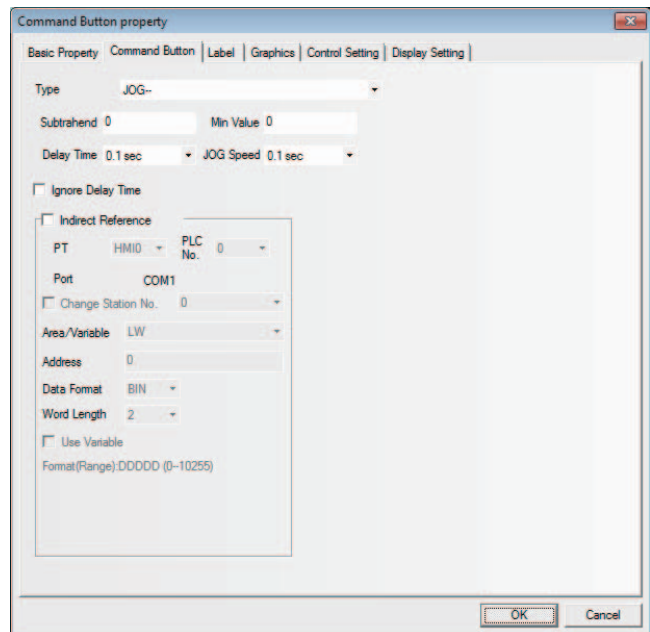
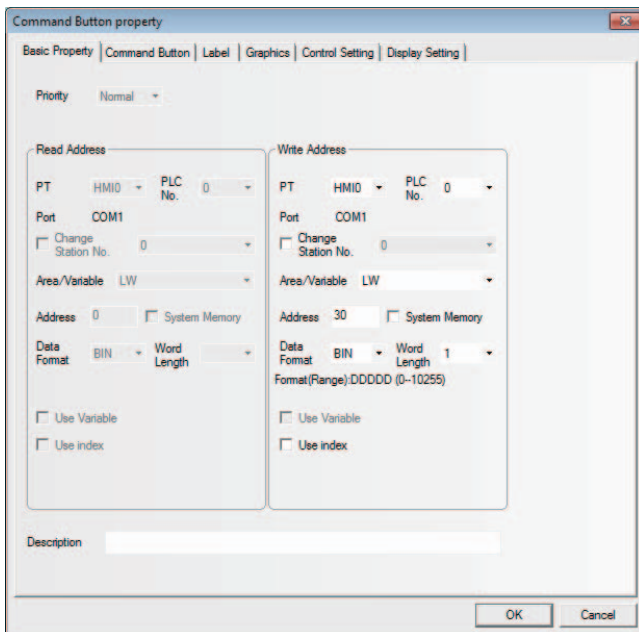
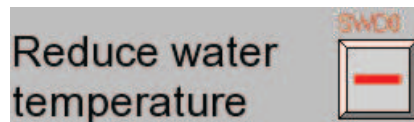

- 10** After [Save], [Compile], [Online/Offline test] or [Download] is selected, the operation effect of the program is as shown below.

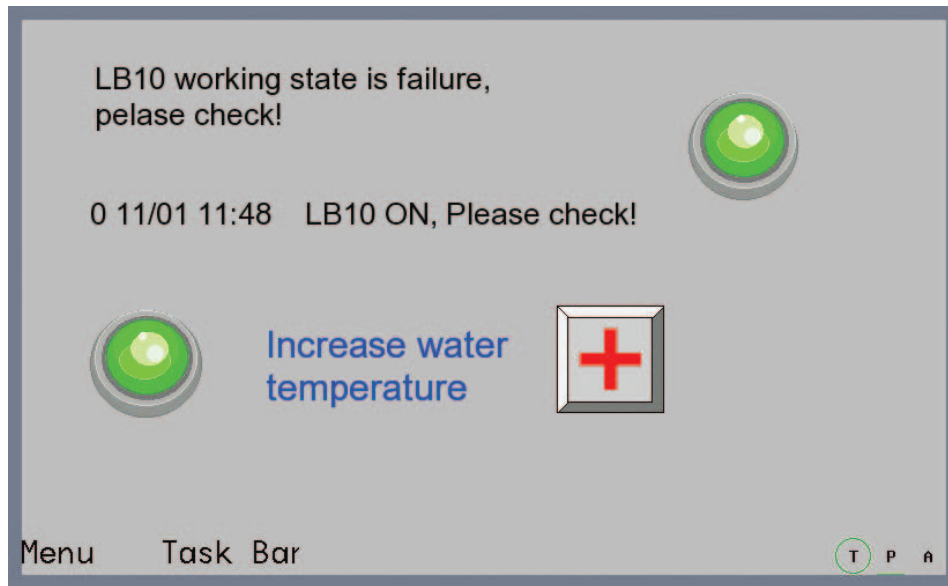

When LB10 or LW30 is triggered for its corresponding triggering conditions is satisfied, the related event information will be displayed. The popup screen 4 and screen 5 for the 2 events registered in the [Event Setting] are the pop-up screens to be ejected when the event is triggered.

- Note 1** For the pop-up screen, it will pop up only when the event is confirmed.
- 2** For the pop-up screen for the event triggering, it can be closed by the <Close screen> for the Function Key or the triggering function <Write Data: No>.

## 3-6-24 Note Book



**Note Book.** Note Book component can modify or display the data in the specified word memory.

The value of the communications address is dealt as ASCII character. The input data is saved to a consecutive memory with the “Read Address” as the first address. Low-byte character codes are displayed on the left, while high-byte character codes are displayed on the right. It supports the display of the multi-line text content and page turning, and can be used to make the operations such as Copy, Cut and Paste etc. for the text contents in the selected area.

### ● Process of adding one Note Book component

- 1** Press the Note Book component icon, drag it to the screen, then the [Basic Properties] dialog box of the Note Book component will pop up.

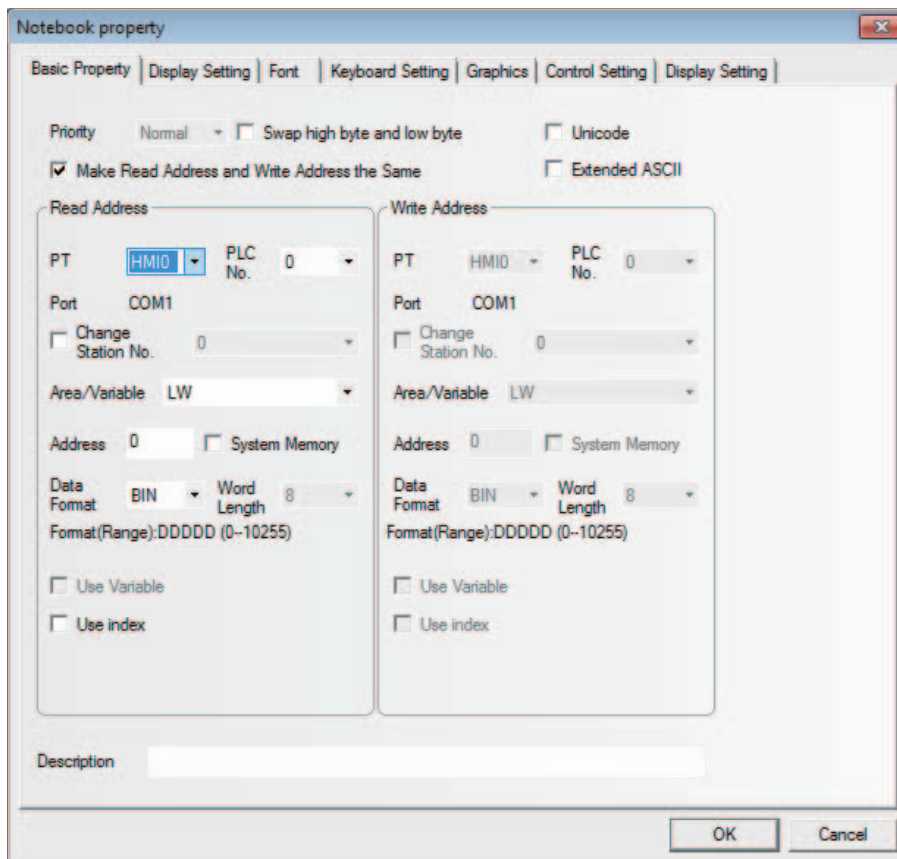

**2** Switch to the [Display Setting] tab.

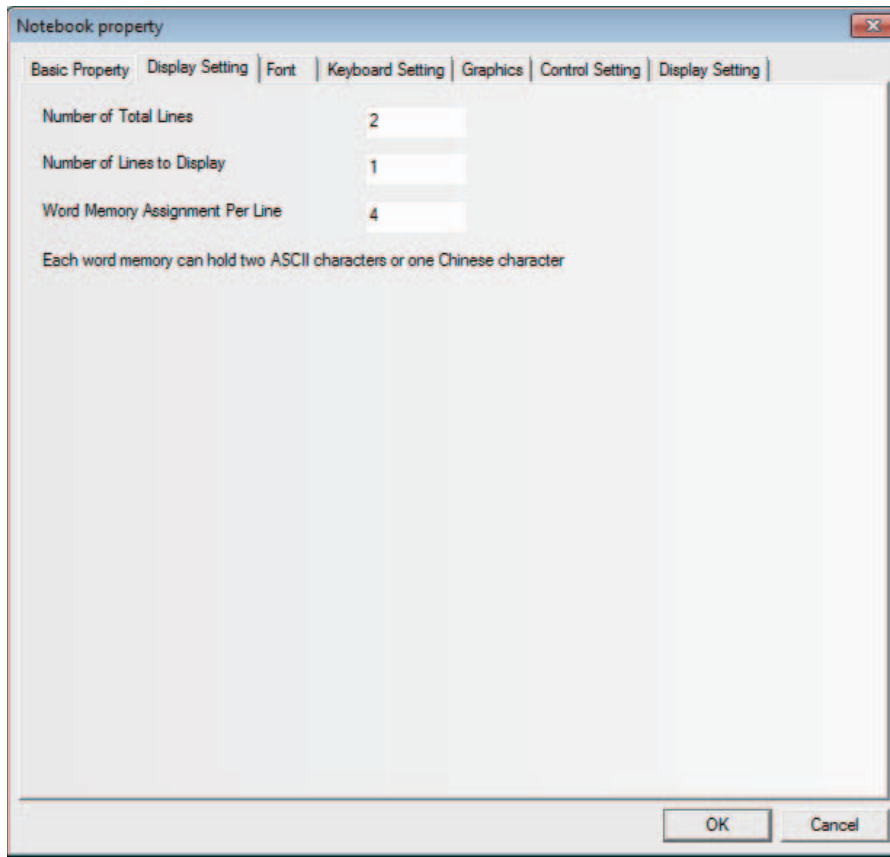

Descriptions of Note Book	
Number of Total Lines	Refers to the total lines of the text that can be input.
Number of Display Lines	Refers to the lines in the display area.
Word Memory Assignment Per Line	Refers to the maximum data length displayed in each line with the unit of "word". It is one byte for ASCII character and two bytes for one word.

**3** Switch to the [Font] tab.

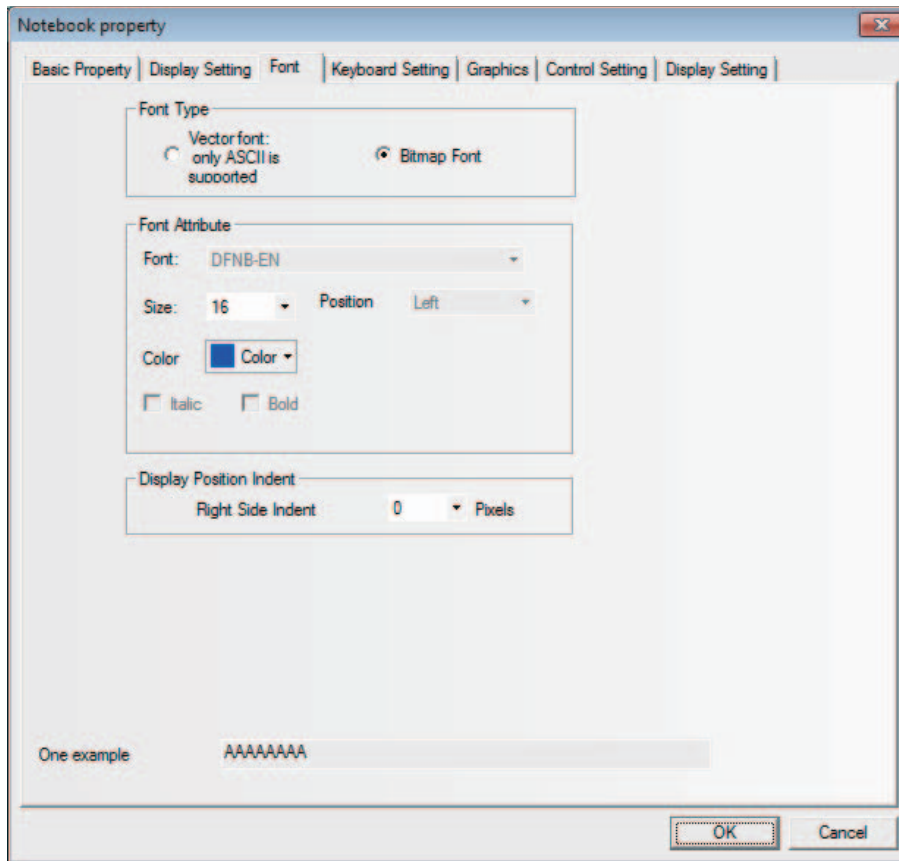

**4** Switch to the [Keyboard Setting] tab.

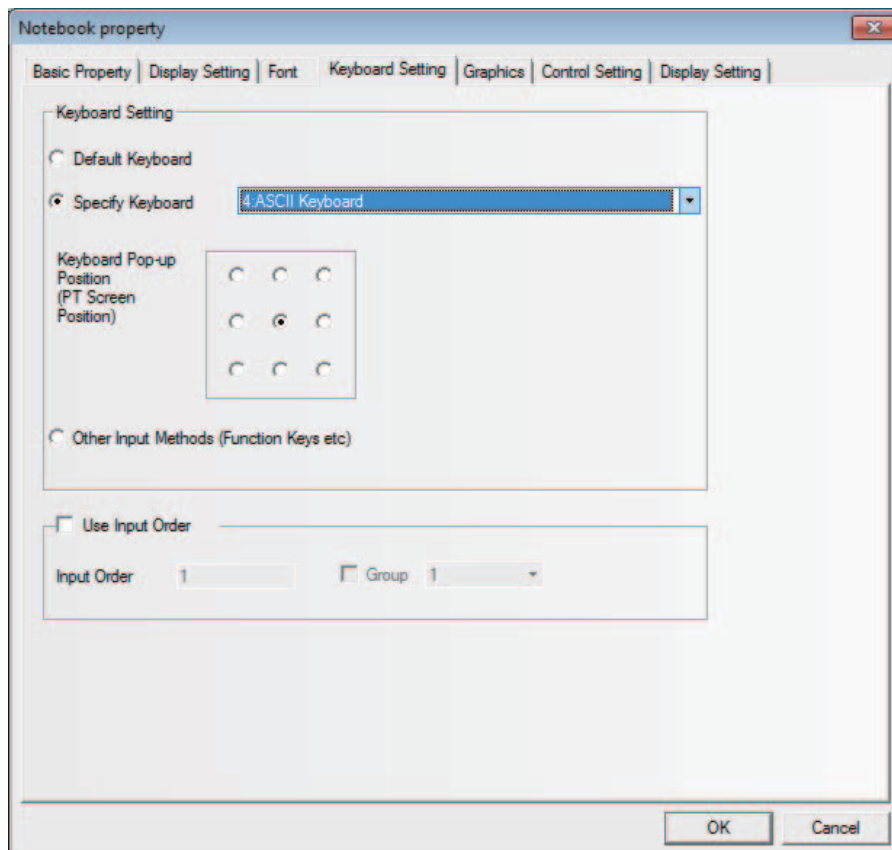



- 5 Switch to the [Graphics] tab and select the Vector Graphics or bitmap representing the touching area and touching state.
- 6 Switch to the [Control Setting] tab and make the Security Setting and set the Triggering action.
- 7 Press the [OK] button to complete the setup of the Note Book component.

The editing of Note Book is as shown below:

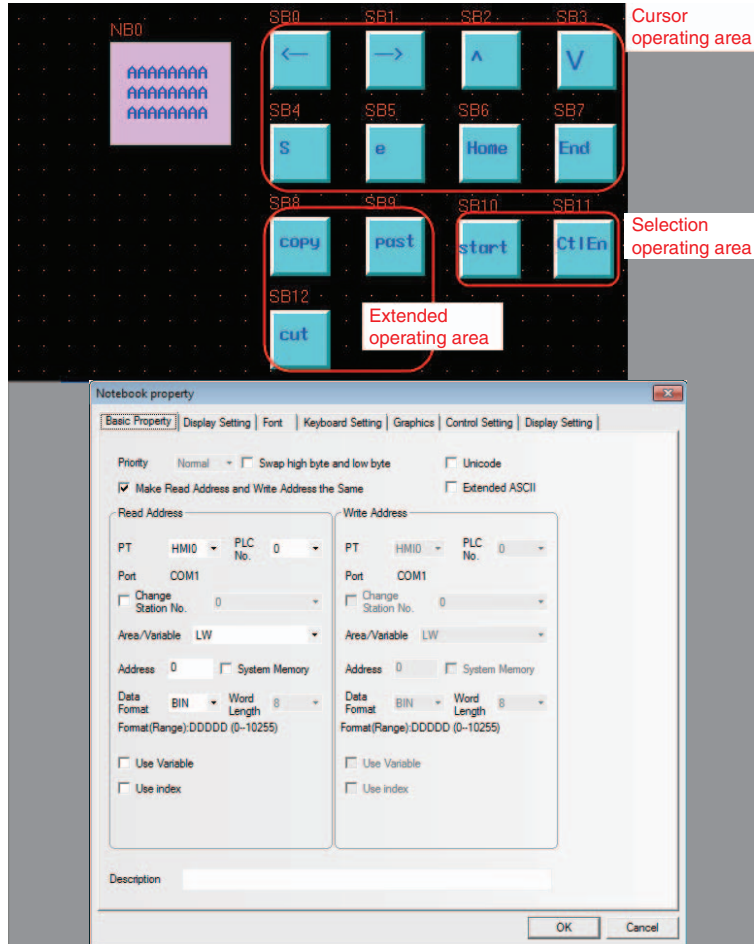

The specific Properties of the Note Book are set as shown below:

LW 9170 is used to realize page turning of the Note Book, and its value represents the start line of the input area. The user can change this value to realize the display of the Note Book in the page-turning way.

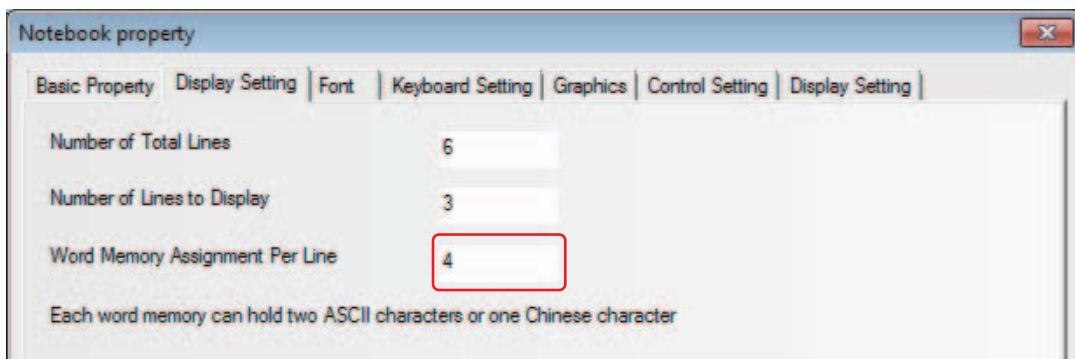

The offline test effect of the Note Book is as shown below:



● Example of using Text Input component to realize PinYin Input

The edited effect is as shown below:



The specific operation is as follows:

- 1 Make “PinYin Input Window” as the screen title, and place one Text component, as shown below.
- 2 Place another function key with the Property “Switch Screen” of “pop-up screen title bar”, which overlaps above the Text component (i.e. PinYin Input Window).

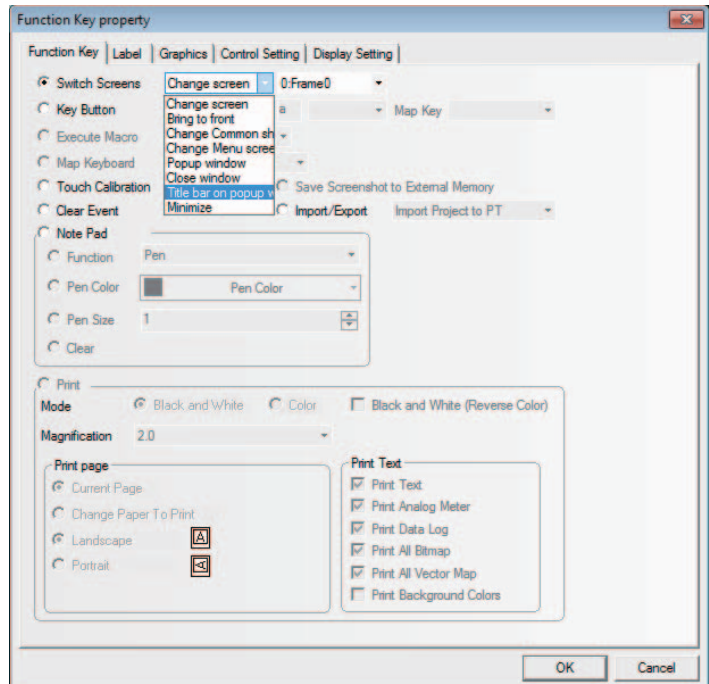
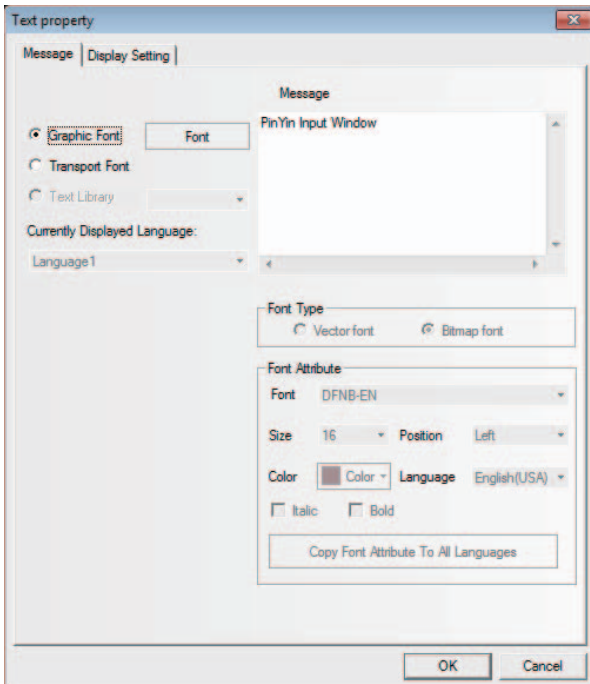

Check “Vector Graphics” in the “Graphics” tab and select one Vector Graphics, as shown below.

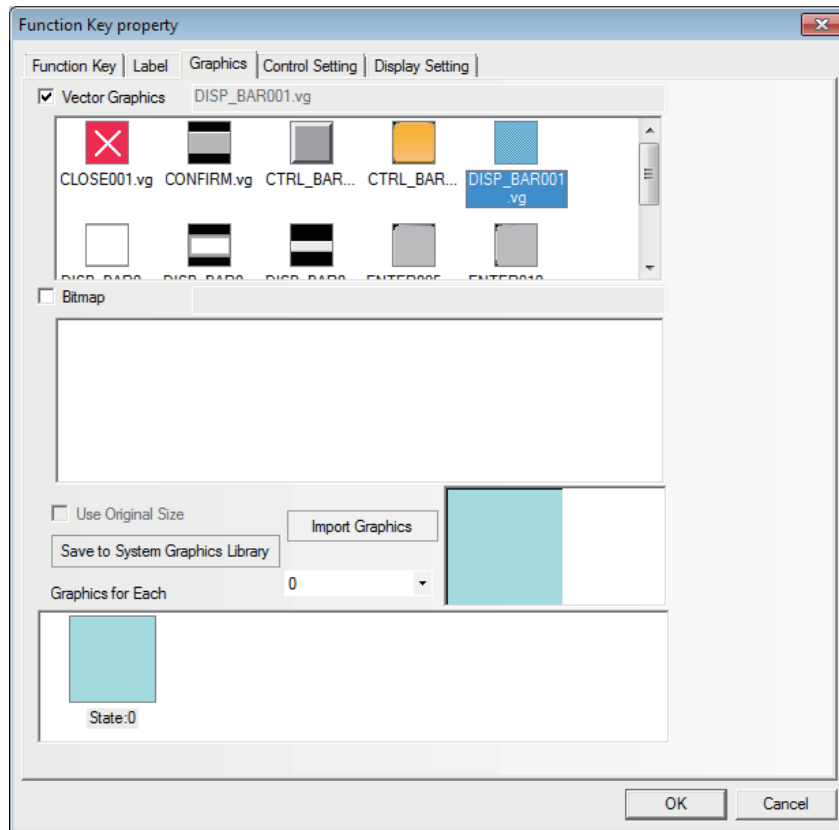

**3** Place one function key with the Property of “Switch Screen” of “Minimize” in the “Function Key” tab. Check “Vector Graphics” in the “Graphics” tab and select one Vector, as shown below.

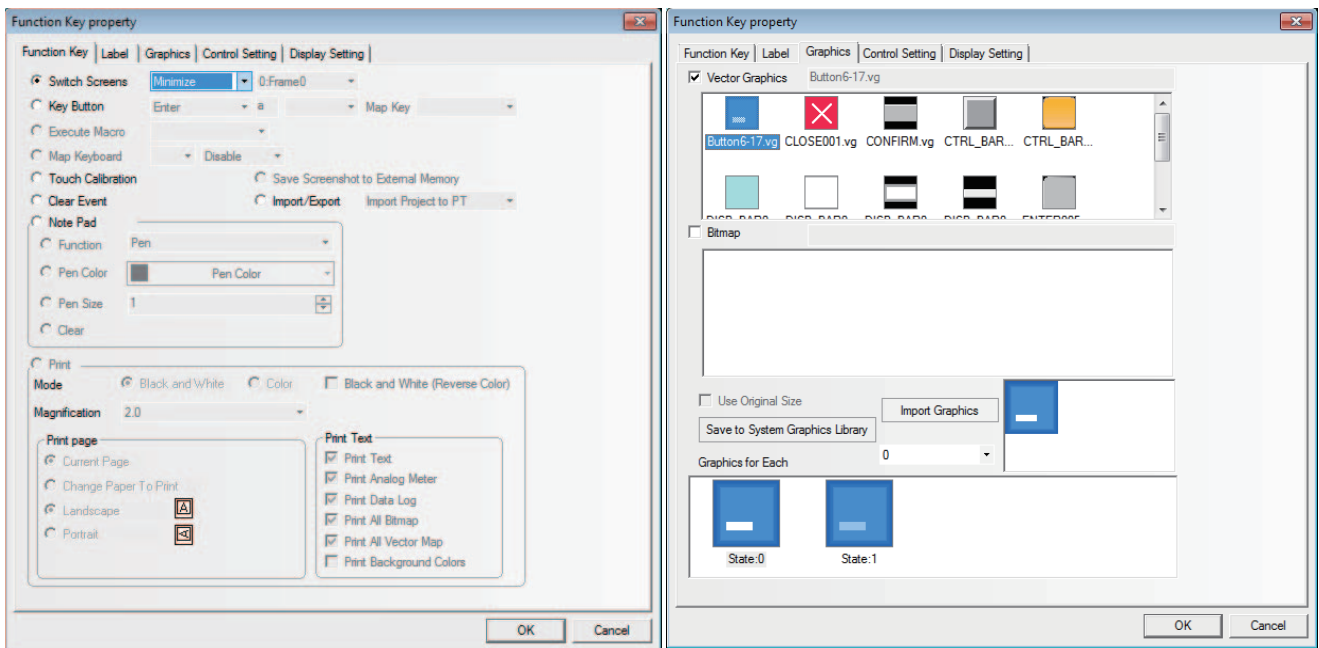

- 4** Place one function key with the Property of “Switch Screen” of “Close Screen” in the “Function Key” tab. Check “Vector Graphics” in the “Graphics” tab and select one Vector, as shown below.

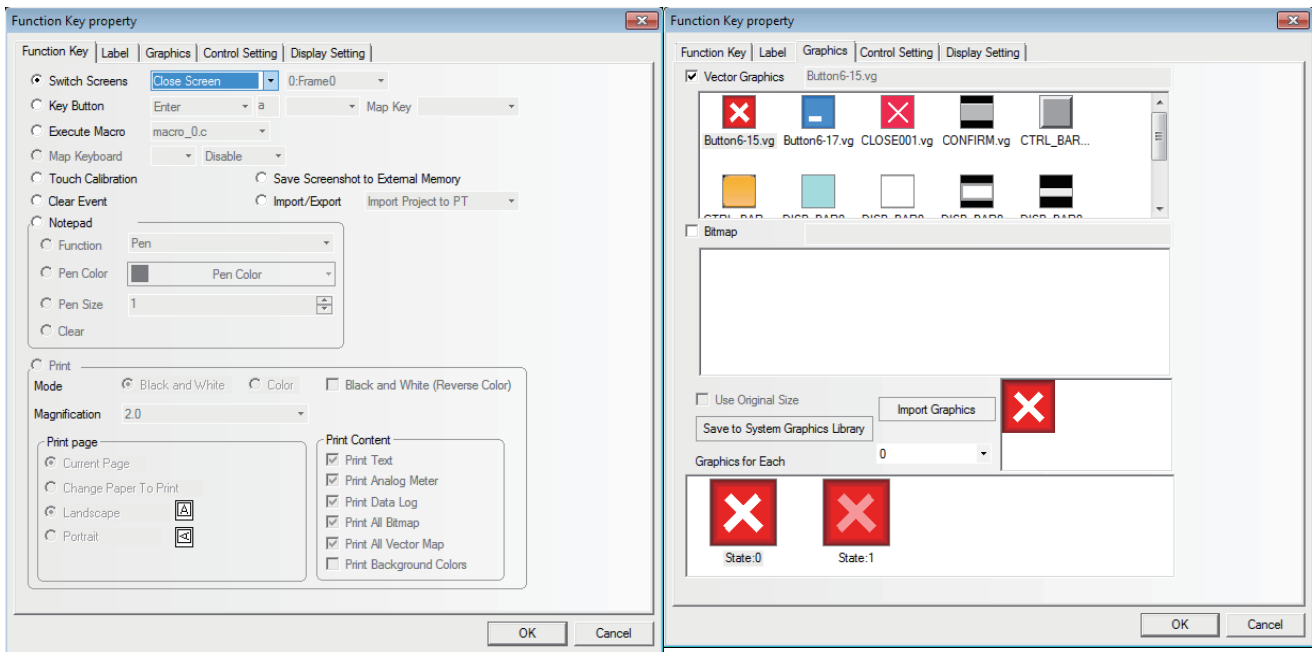

- 5** Place one Text Display component LW9152 with the “Word Length” of “16”.

- 6** Place one static Text Display component with the contents of “Please input your name.”.

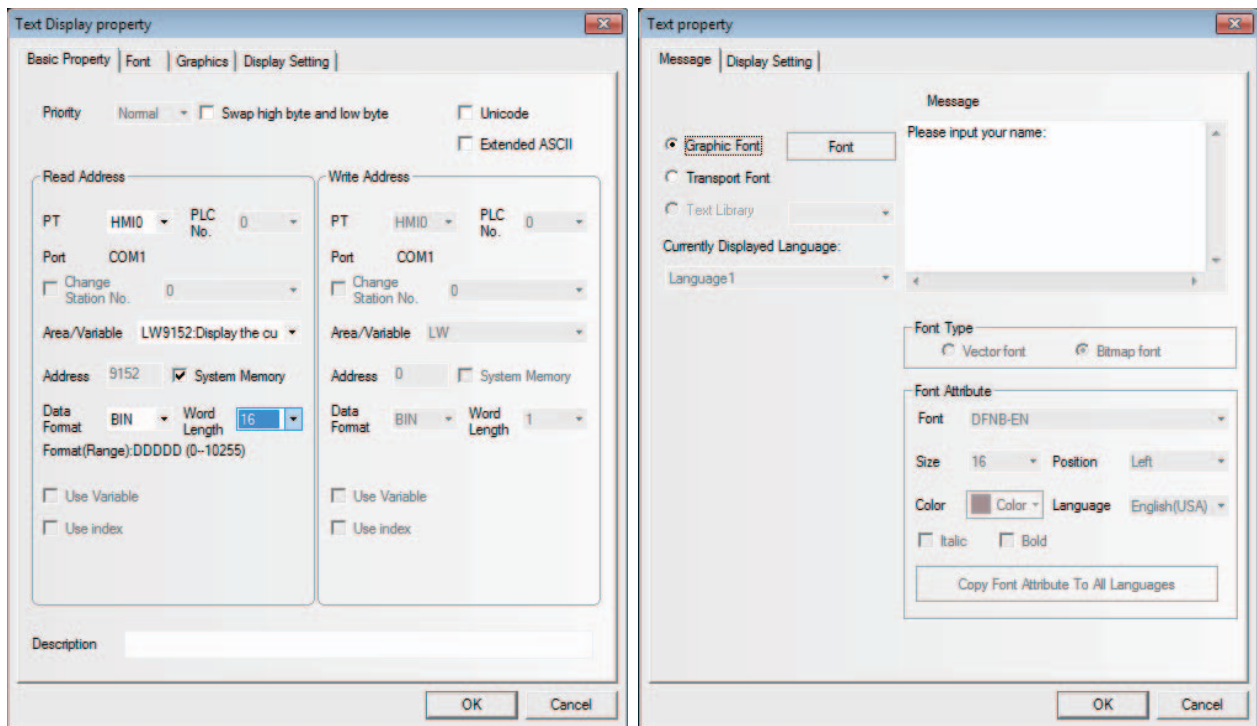

- 7 Place another Text Input component LW20 with the “Word Length” of “4”.
- 8 Create one Bit Button component with the “Write Address” of LB9100 in the “Basic Properties” tab, “Type” in the “Bit Button” tab of “Alternate”, “Transport Font” being checked together with the State 0 and State 1 of “English” and “ 中文 ” respectively.

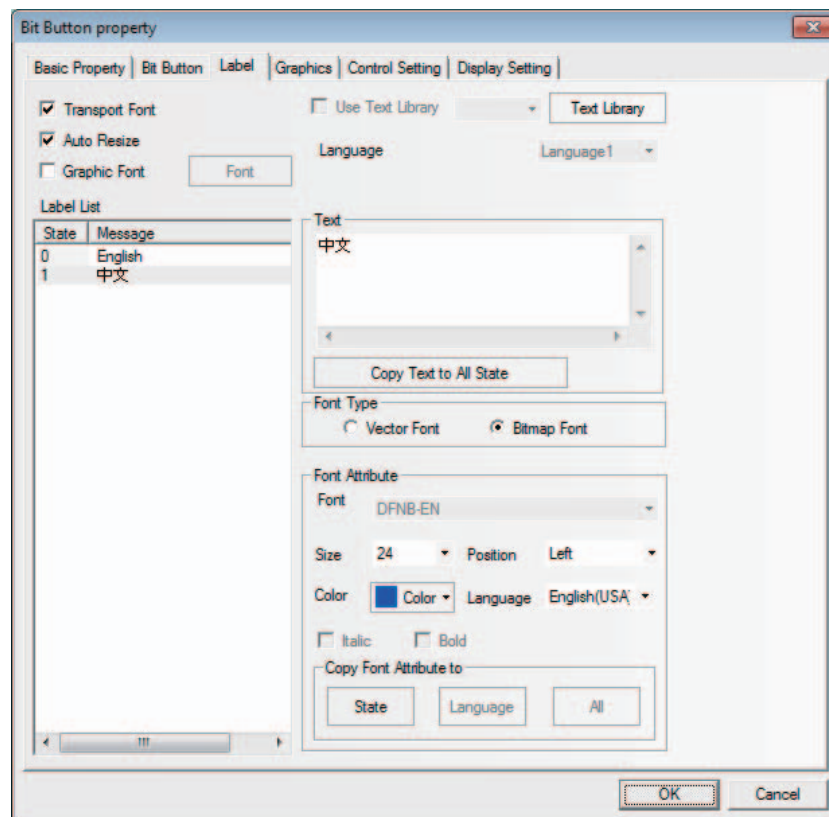
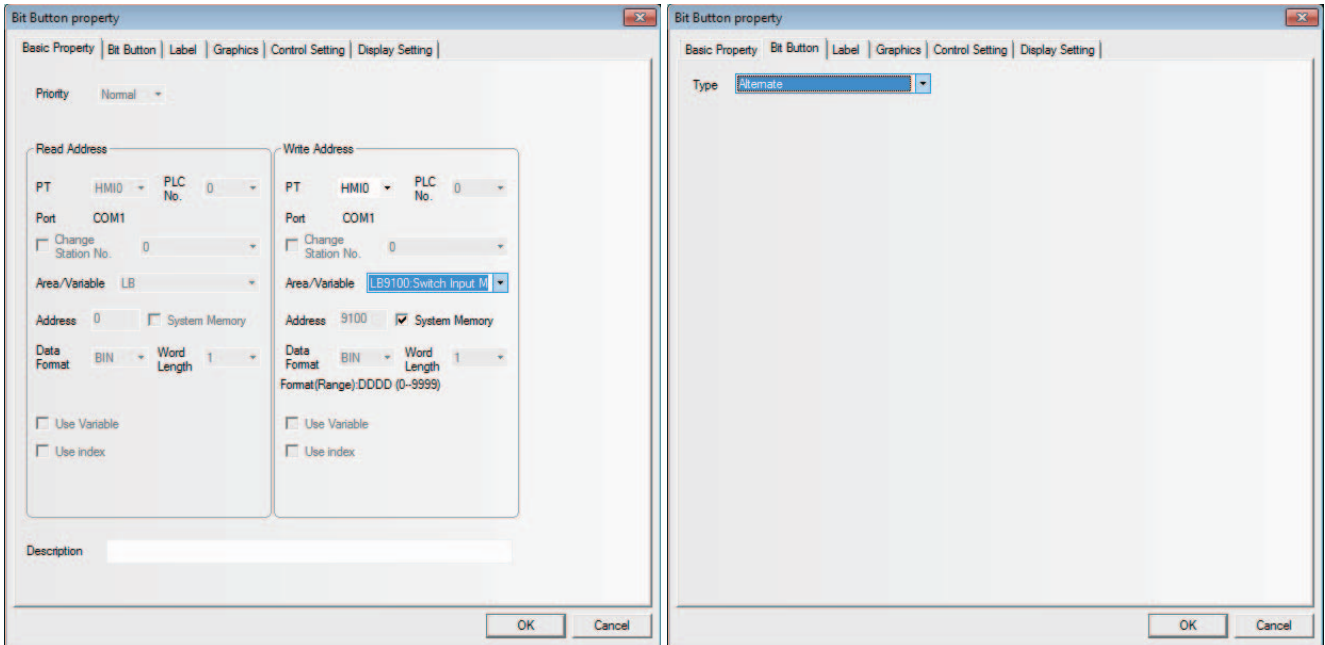

- 9** Place one Command Button component LW9150 with “Type”, “Addend” and “Max Value” of “Add value”, “8” and “100” respectively in Command Button tab and the Label of “PgDn”.

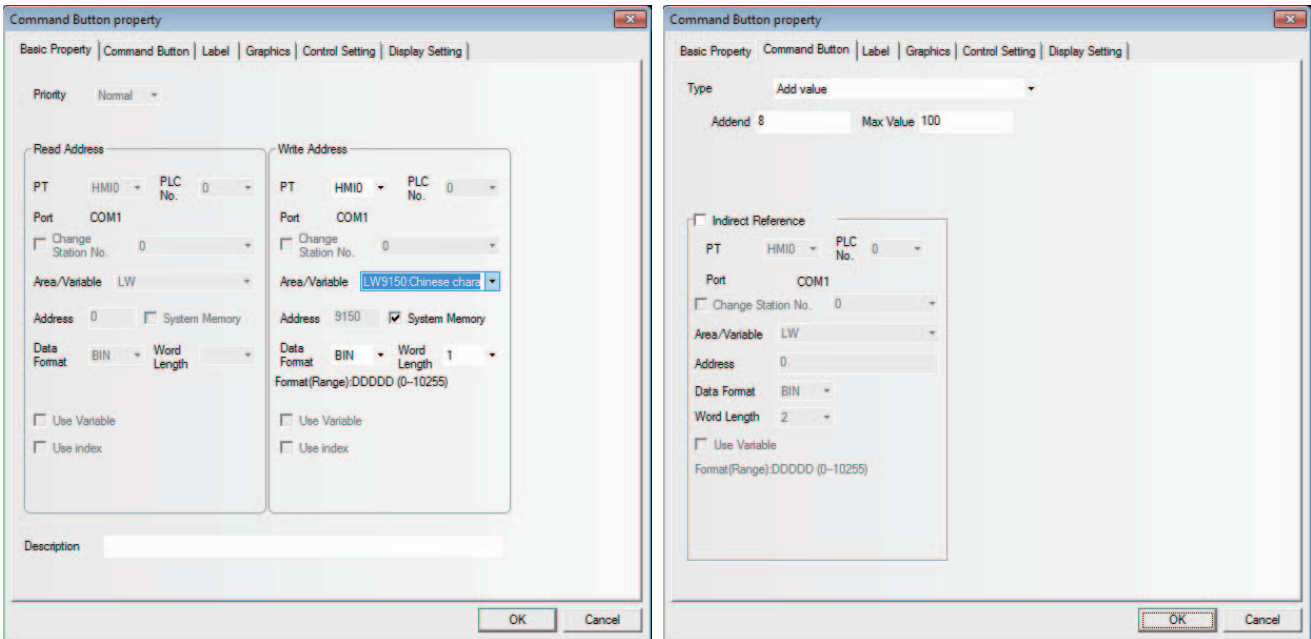

- 10** Place one Command Button component LW9150 with “Type”, “Subtrahend” and “Min Value” of “Subtract value”, “8” and “0” respectively in Command Button tab and the Label of “PgUp”.

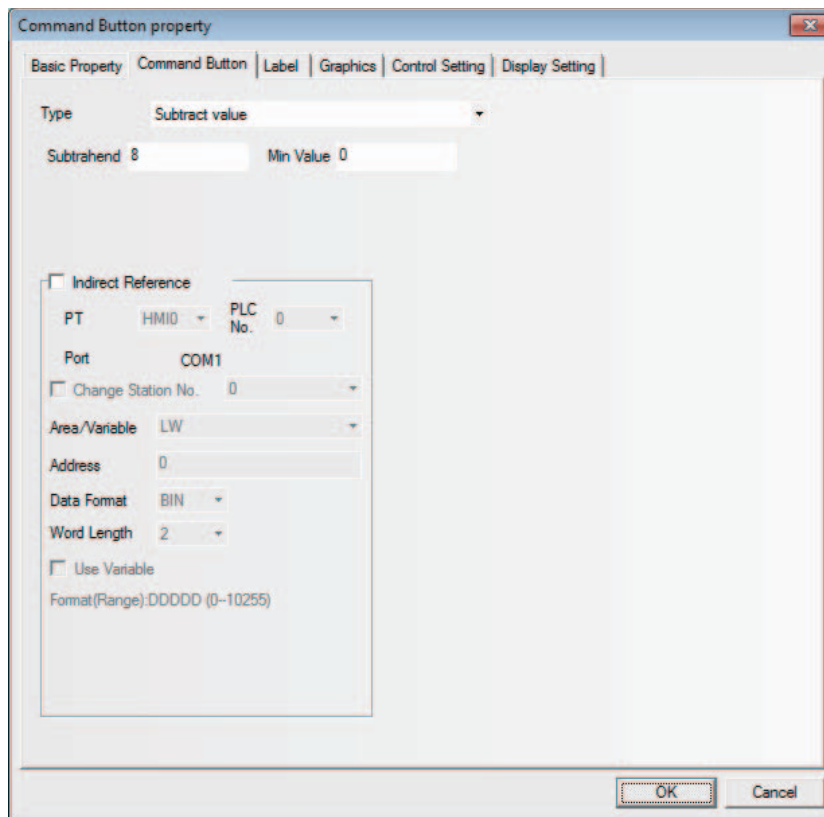

After all the components are placed well, the operation are as follows:

- 1 Trigger the Text Input component to make the cursor appear, as shown below.



- 2 Click the English-Chinese Switch once, then the input bar for Chinese input will appear, as shown below.

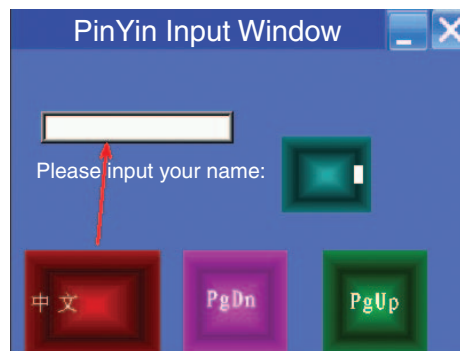

- 3 Several homophones will appear in the Chinese input bar after the PinYin character is input, and you can use the "PgUp" or "PgDn" button to realize page turning, and trigger the related Chinese character to complete one Chinese character input process. As shown below, for example, if “张三” needs to be input, you just need to enter “zhang” through the character keyboard.

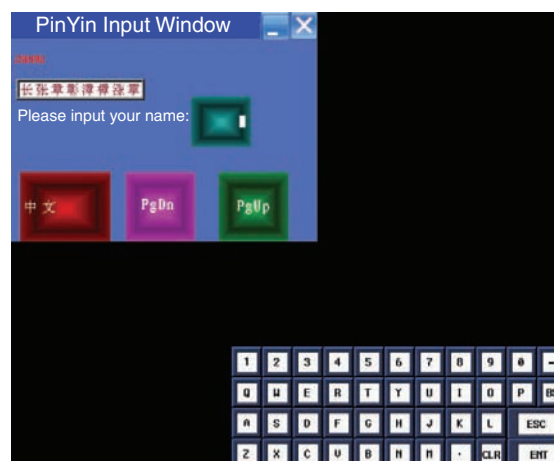

Later, when “张” is triggered, “张” will be displayed in the Text Input component, as shown below.

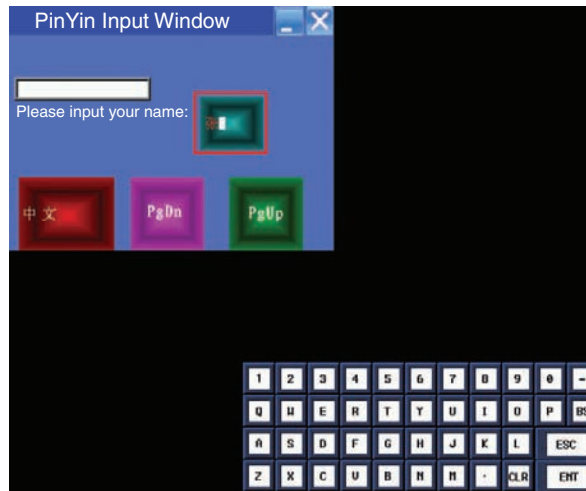

Trigger “三” after PinYin “san” is input, “三” will be displayed in the Text Input component.

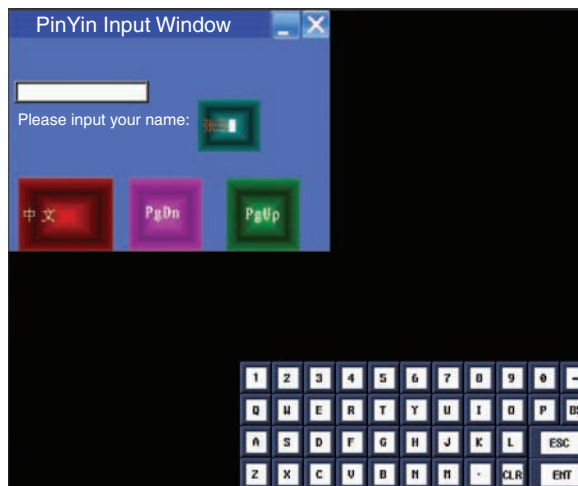

Press “ENT” button in character keyboard to complete this input.

**Addition1** If the character needs to be changed during the input process, the function keys of “BACK” or “Clear” in the keyboard can be used to realize this operation.

2  , triggering the blank area of the Chinese Character Display screen can realize the movement of this screen, which is similar to the screen console of the function key.

**4** Clicking the “PinYin Input Window” bar can realize the screen movement, as shown below.





**5** Clicking the “Minimize (i.e. “-”) icon” can make the screen minimized to the task bar. And clicking the task bar again will make the screen return to the state before it is minimized.

**6** Clicking the “Close (i.e. “X”)” icon to close the screen.

The PinYin Input for the Note Book is similar to that for the Text component, and many Properties of the Note Book component are realized through the function keys.

### 3-6-25 Word Neon Lamp



The text string which is specified as Label is displayed in loopy-moving way, and it supports the label contents corresponding to 256 (max.) states in the loopy-moving way.

#### ● Process of adding one Word Neon Lamp component

**1** Press the Word Neon Lamp component icon, drag it to the screen, then the [Basic Properties] of Word Neon Lamp component will pop up.

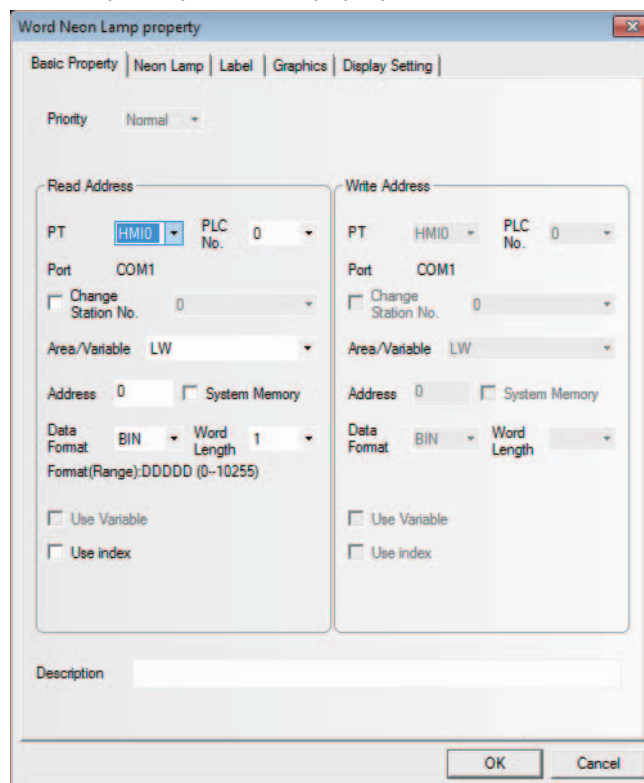

**2** Switch to the [Neon Lamp] tab and make settings of “Moving Type”, “State No.”, “Step” and “Speed” respectively.

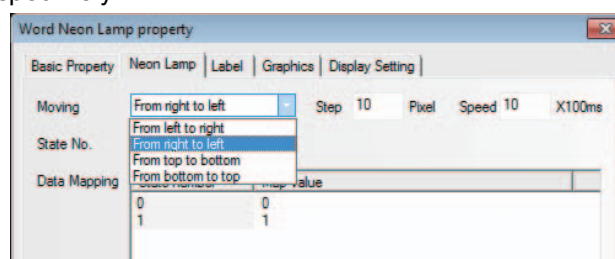

- 3** Switch to the [Label] tab and add the text corresponding to the state.
- 4** Switch to the [Graphics] tab and select the Vector Graphics or bitmap representing the touching area and touching state.
- 5** Press the [OK] button to complete the setup of the Word Neon Lamp component.

### 3-6-26 Bit Neon Lamp



The text string which is specified as Label displayed in loopy-moving way, and it supports the label contents corresponding to State 0 and State 1 in the loopy-moving way.

The difference of the Word Neon Lamp and the Bit Neon Lamp is the controlling method, and the former selects the different states ranging from 1 to 256 by changing the memory value, while the latter changes the display state (only 2 states available) by changing the state of the control bit.

#### ● Process of adding one Bit Neon Lamp component

- 1** Press the Bit Neon Lamp component icon, drag it to the screen, then the [Basic Properties] of Bit Neon Lamp component will pop up.

Bit Neon Lamp property

Basic Property | Bit Neon Lamp | Label | Graphics | Display Setting

Priority Normal

Read Address

PT HM10 PLC No. 0

Port COM1

Change Station No. 0

Area/Variable LB

Address 0  System Memory

Data Format BIN Word Length 1

Format(Range): DDDD (0-9999)

Use Variable

Use index

Write Address

PT HM10 PLC No. 0

Port COM1

Change Station No. 0

Area/Variable LB

Address 0  System Memory

Data Format BIN Word Length 1

Use Variable

Use index

Description

OK Cancel

- 2** Switch to the [Bit Neon Lamp] tab and make settings of “Moving Type”, “Step” and “Speed” respectively.

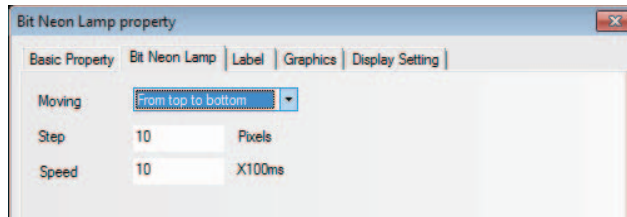

- 3** Switch to the [Label] tab and add the text corresponding to the state.
- 4** Switch to the [Graphics] tab and select the Vector Graphics or bitmap representing the touching area and touching state.
- 5** Press the [OK] button to complete the setup of the Bit Neon Lamp component.

### 3-6-27 Touch Trigger



The Touch Trigger component is applicable to the conditions where the several components can be triggered to act not through the triggering method. When the triggering conditions for the specified memory of the Touch Trigger component are satisfied, the components placed in the valid area for the Touch Trigger component can be triggered to act.

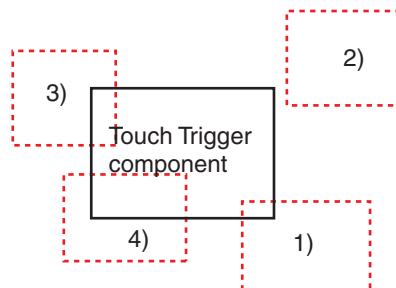

1), 3) and 4) locate in the valid triggering area, while 2) locates in the invalid triggering area.

Therefore, when the set triggering conditions for the specified memory of the Touch Trigger component are satisfied, the components in area 1), 3) and 4) will be triggered, while that in area 2) will not be triggered.

## ● Process of adding one Touch Trigger component

- 1 Press the Touch Trigger component icon, drag it to the screen, then the [Basic Properties] dialog box of Touch Trigger component will pop up.

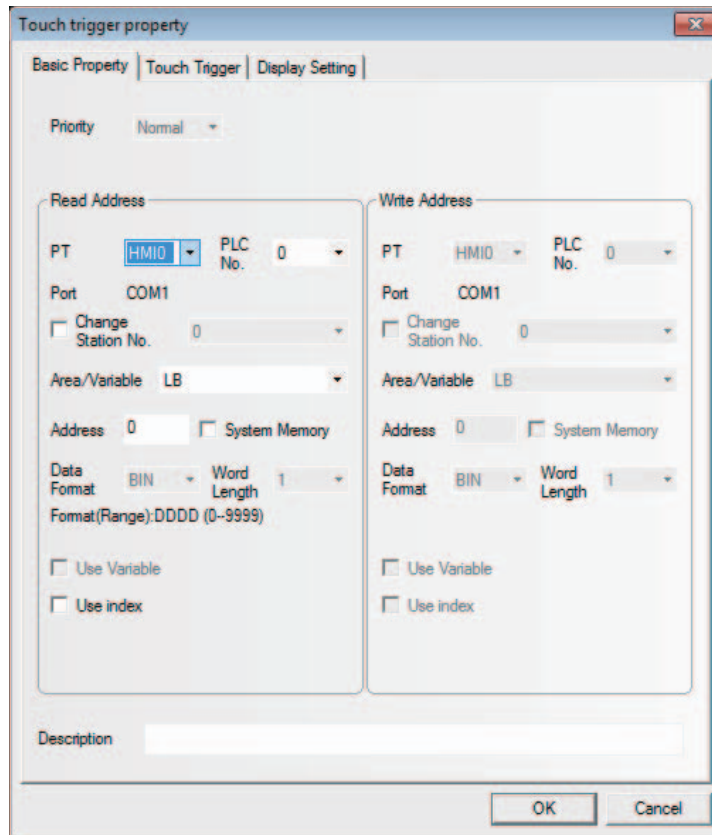

- 2 Switch to the [Touch Trigger] tab and select the Trigger Type.

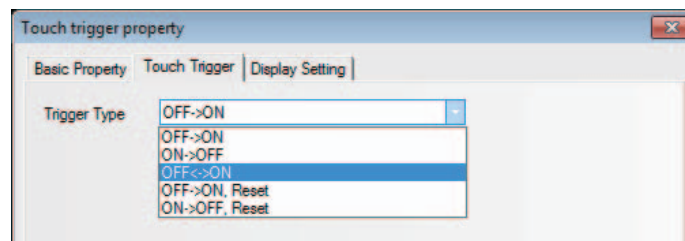

- 3 Press the [OK] button to complete the setup of the Touch Trigger component.

3-6-28 Table

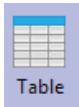

The Table component can make the selection type of “Select by row”, “Select by Column” and “Select by cell”. The user can set the “Row”, “Column”, “Color when Selected”, “Background Color”, “Border Color”, and write the selected Row No. and Column No. into the specified memory.

● Process of adding one Table component

- 1 Press the Table component icon, drag it to the screen, then the [Basic Properties] dialog box of the Table component will pop up.

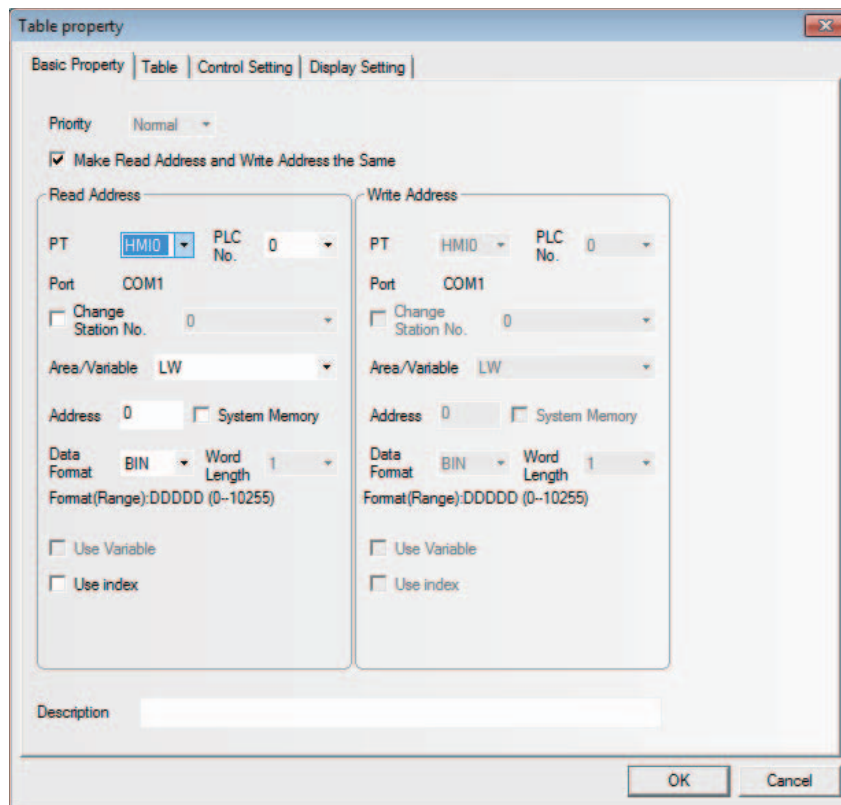

- 2 Switch to the [Table] tab and make the settings of “Row”, “Column” and “Type”.

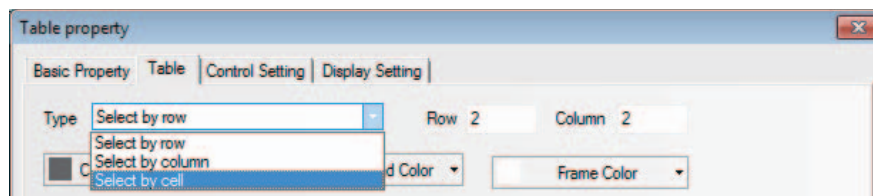

The related Properties are as follows:

Type	Select by row	Select by col	Select by cell
memory corresponding to Row	First address	-	First address
memory corresponding to Column	-	First address	First address + 1
Number of Occupied memories	1	1	2

- 3** Switch to the [Control Setting] tab and make the Security Setting and set the Triggering action.
- 4** Press the [OK] button to complete the setup of the Table component.

The test effect of the Table component is as shown below.

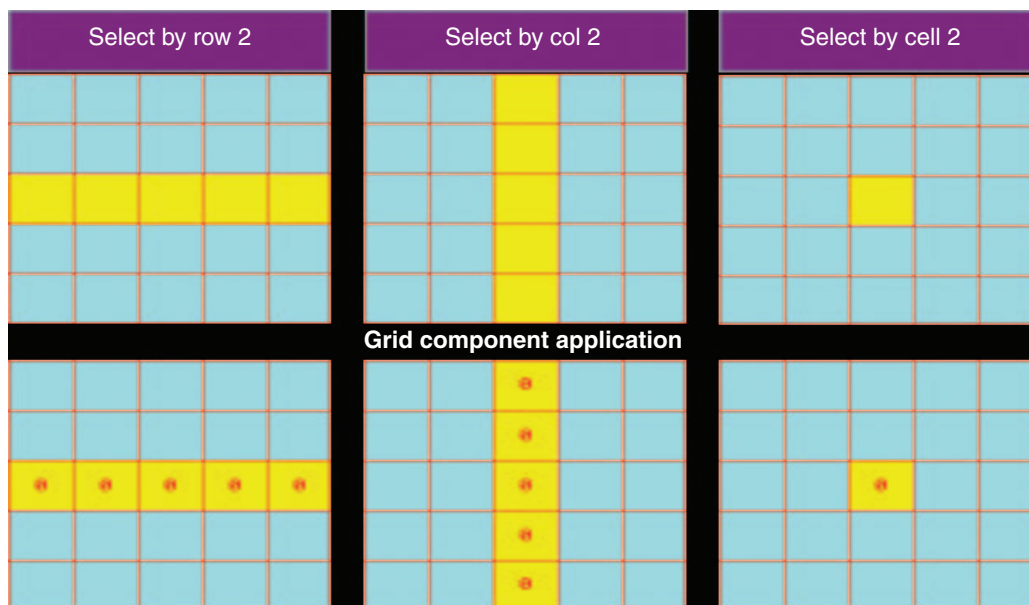

If required, the Table component can also be used in combination with the Number Input component and the Macro, thus controlling the display condition through the Macro.

### 3-6-29 Data History

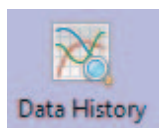

The Data History component can be used to read a series of data in consecutive memories from the specified word memory(s) inside PT, PLC or word memory(s) of the controller periodically and display them in the table form.

- Note 1** The sampled data must be consecutive. When the “Save to Recipe Data Field” is checked in the [Save Data History] tab, only the saving of a little amount of data is possible for the limited capacity of recipe data field.
- 2** The [Read Address] for the Data History component is the memory address for data sampling by the 1st channel.
  - 3** The Word Length of memory for Data History component is determined by the channel number, i.e. if channel number is  $m$  ( $0 < m < 17$ ), the World Length will be  $m$ .
  - 4** Using the Data History component, the user must be check “Save to Recipe Data Field” options in the [Save Data History] tab in the [Data History Component Property] dialog box.

## ● Process of adding one Data History component

- 1 Press the Data History component icon, drag it to the screen, then the [Basic Properties] dialog box of the Data History component will pop up.

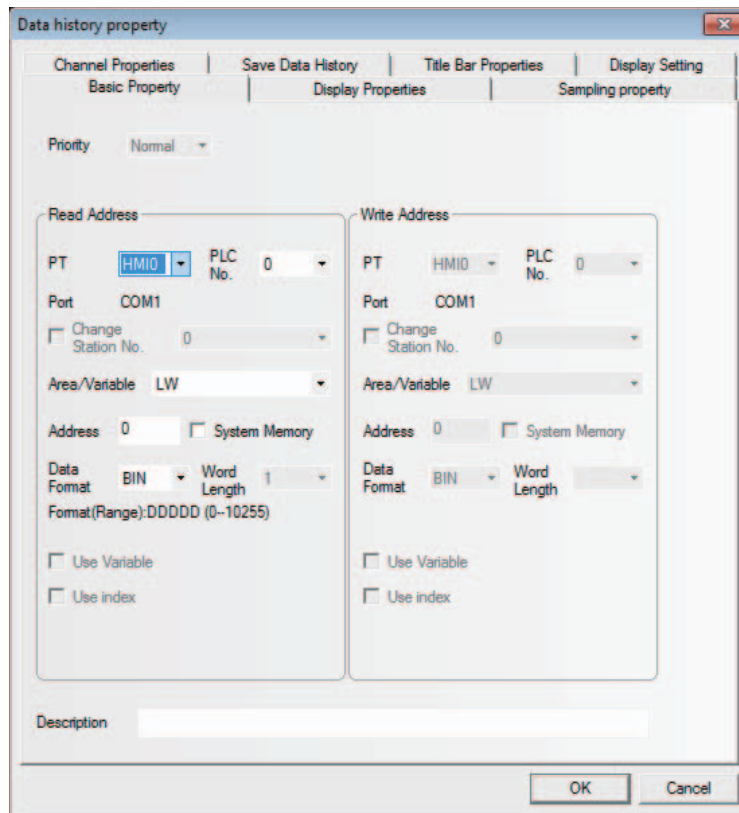

- 2 Switch to the [Display Properties] tab and make the settings of display format and color etc.

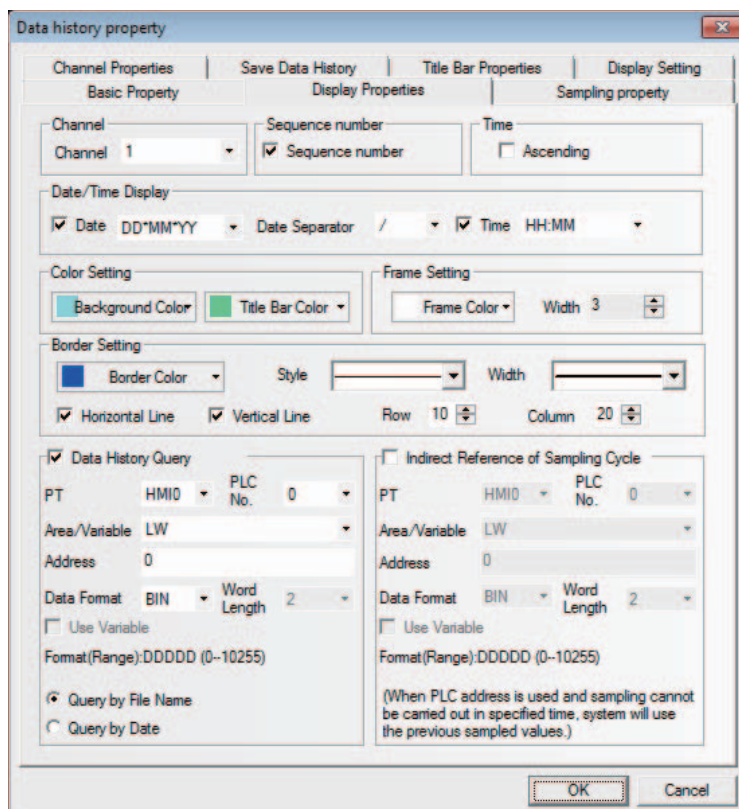

Descriptions of Display Properties		
Channel	Refers to the channel number of the memory to be sampled, and the channel is up to 16.	
Sequence number	Determines whether to display the No. of the sampling data information.	
Ascending	When this option is checked, the sampling data information will be displayed in the ascending order, i.e. the latest sampling data will be displayed on the bottom.	
Date/Time Display	Date	Checking in the checkbox allows the sampling date displayed in the selected date format. The 3 formats are available, and YY, MM and DD refer to the year, month and date respectively.
	Date Separator	Selects the data separator with 3 formats available. For example: 11/06/24.
	Time	Checking it means the sampling time will be displayed and the time format can be selected. There are 3 formats available, and HH, MM, SS and MS refer to the hour, minute, second and millisecond respectively.
Color Setting	Sets the Background Color and Title Bar Color for the table respectively.	
Frame Setting	Sets the Frame Color and Width for the table.	
Border Setting	Set the color, types, and width of Border, row spacing, and column spacing with the unit of "pixel point". Checking the "Horizontal Line" check box means the border will be displayed horizontally, and checking "Vertical Line" means the border will be displayed vertically.	
Data History Query	The historical sampled data stored in the external memory can be searched by address of the word memory specified in "Data History Query" setting. The Word Length of the specified memory address is 2 by default.	
	Query by File Name	With the "Query by File Name" being checked, it means to call out the data history sampled today or in the latest day when the value of specified memory is 0, while the data history sampled in the last time when the value of specified memory is 1, and so on.
	Query by Date	When "Query by Date" is checked, the date will be input into the specified memory and the data history corresponding to the date will be called out. The date format is yyyyymmdd, where yyyy, mm and dd refer to year, month and date respectively.
Indirect Reference of Sampling Cycle	When Indirect Reference is used, the sampling time will be read from the specified memory.	

**Note** When the variable is specified in the sampling cycle, if the value cannot be obtained within the regulated time, the value which was obtained previously will be used.



- 3** Switch to the [Sampling Property] tab and make the settings of “Sampling Method”, “Cycle”, “Sampling Points” and “Pause-Clear” and etc.

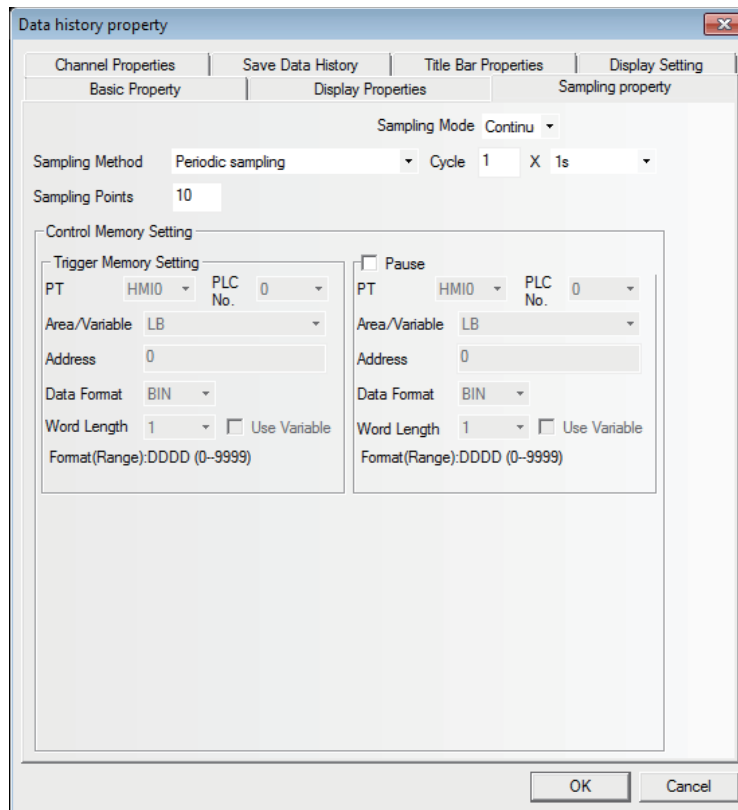

**Descriptions of Background Property**

Sampling Method	Periodic sampling	The data is sampled timely.
	OFF→ON trigger sampling	Only when the state of the specified bit address turns ON from OFF, the sampling is triggered.
	ON→OFF trigger sampling	Only when the state of the specified bit address turns OFF from ON, the sampling is triggered.
	OFF←→ON trigger sampling	Only when the state of the specified bit address changes, the sampling is triggered.
	OFF→ON reset trigger sampling	Only the state of the specified bit address turns ON from OFF, the sampling is triggered, and the state of the specified bit address will be reset automatically after the triggering.
	ON→OFF reset trigger sampling	Only the state of the specified bit address turns OFF from ON, the sampling is triggered, and the state of the specified bit address will be reset automatically after the triggering.
Cycle	Refers to the interval between 2 sampling points with the unit of “s” or “100 ms”.	
Sampling Mode	Continue	When all the sampling points end, the sampling still continues.
	Once	When all the sampling points end, the sampling will stop, which means sampling is only performed once.
Sampling Points	When the sampling method is “Once”, the sampling will stop after the set “Sampling Points” is finished.	
Trigger memory Setting	When the Trigger memory Setting is used for the sampling method, the memory address to be read will be specified.	
Pause- Clear	The default Word Length is 2. “Pause” function can stop the data sampling operation temporarily. In addition, the “Clear” function here is invalid for the Data History component.	

**Note** When the trigger sampling is used, if multiple samplings are executed at the same timing, only single value might be acquired.  
When such a state is assumed, place the Data Transmission component and others on the Common Sheet and acquire the necessary data at local memory to perform the sampling for the local memory.

- 4 Switch to the [Channel Properties] tab and set the display information for each channel.

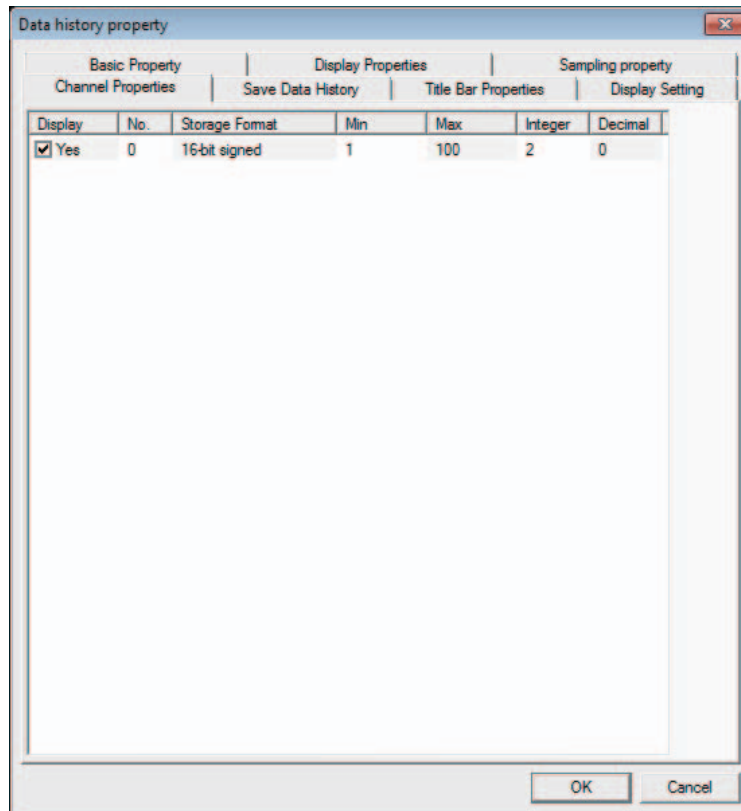

- 5 Switch to the [Save Data History] tab and set the "Start Address." etc. to be saved.

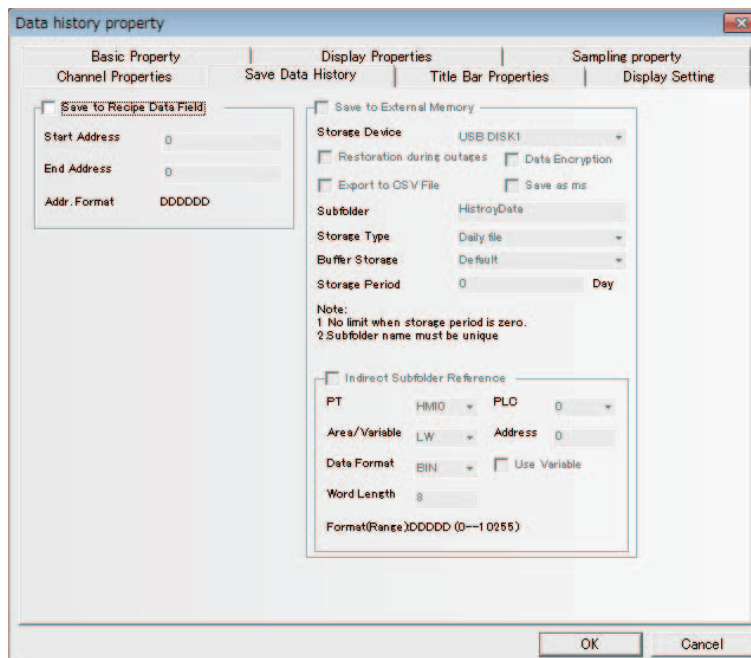

- When the Data History component and the Data Log component are used in combination and their addresses are the same, it just needs to set “Save to Recipe Data Field” for either of them.
- If the Data History component is needed to display the value of the Data Log, the value in PLC can be transmitted to the LW of the local memory by the Timer or the Data Transmission component.
- If the user needs to save the data for a long period and has low requirement of the interval for the data saving, it is recommended the sampling time will be as long as possible.
- The memory area of the Data History includes "information area" for 40 bytes or 20 words. Additionally, the memory area includes the "time area" indicating sampled points x 4 words per page and the "data area" indicating sampled points x word length per page.
- When the storage period is set, the file deletion is performed at the first sampling after the startup and every 24 hours. At the timing, any files which is beyond the storage period are deleted.

**6** Switch to the [Title Bar Properties] tab and make settings of “Title” and “column font” etc.

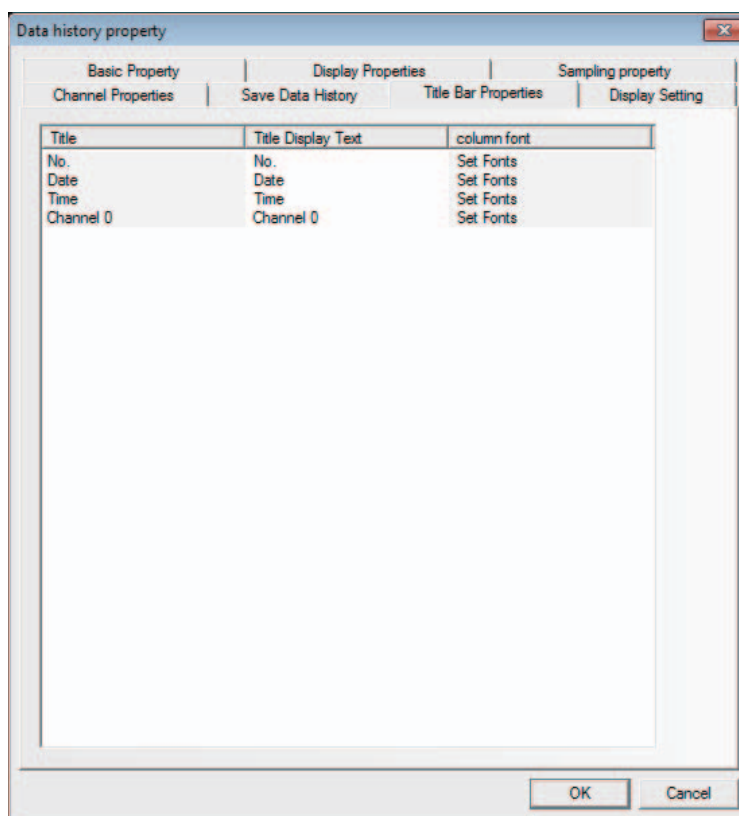

**7** Press the [OK] button to complete the setup of the Data History component.

## 3-7 Function Parts

### 3-7-1 Scale



It is applicable to the conditions with the requirement of equal-division notation.

#### ● Process of adding one Scale component

- 1 Press the Scale component icon, drag it to the screen, then the [Scale Property] dialog box will pop up.

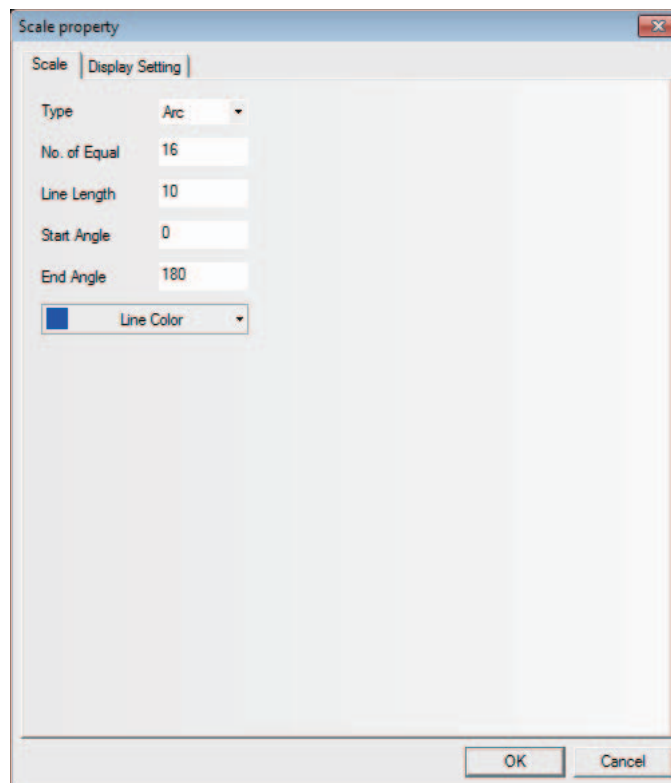

**Type:** Includes Vertical, Horizontal, Arc and Circularity.

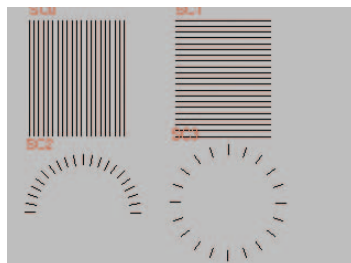

**No. of Equal:** Set the number of equal-division for the graphics between 2 and 255.

**Line Length:** Set the length of the scale between 1 and 24.

**Start Angle/End Angle:** The start angle and the end angle of the arc between 0 and 360 degree.

- 2 Press the [OK] button to complete the setup.

## 3-7-2 Function Key



**Function Key** Function Key provides functions such as “Switch Screens”, “Keyboard Function”, “Execute Macro”, “Touch Calibration”, “Clear Event” and “Message Board” etc. The function key is not controlled by the memory address, so the execution of specified function needs to be activated by touching this component.

### ● Process of adding one Function Key

- 1 Drag the Function Key icon after it is pressed and display “Function Key Property”. In “Function Key” tab, allocate functions such as “Switch Screens”, “Key Button”, “Execute Macro”, “Touch Calibration”, “Clear Event”, “Notepad” for each function key. The NB-S series does not support “Print” currently.

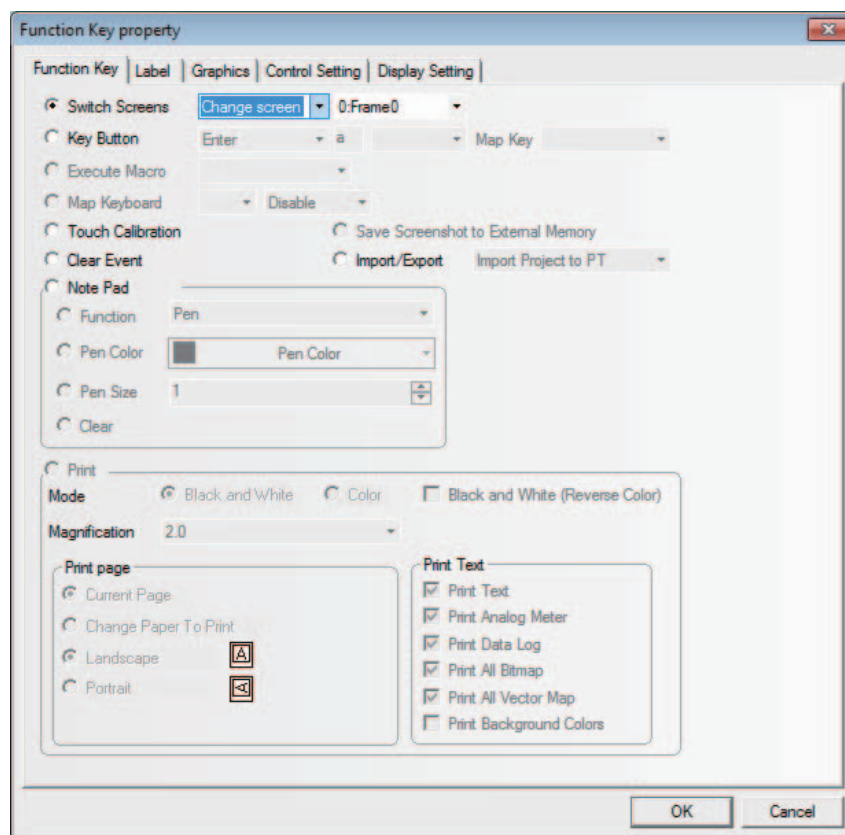

- 2 Go to the [Label] tab and fill in the text to be displayed.
- 3 Go to the [Graphics] tab and select the Vector Graphics or Bitmap to display the state.
- 4 Go to the [Control Setting] tab and make the Security Setting and set the Triggering action.
- 5 Press the [OK] button to adjust the position and size of the Function Key.

● **Function Key**

**1** Switch Screen

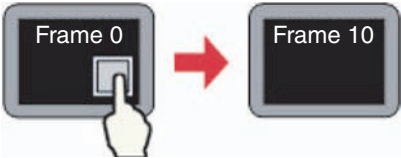
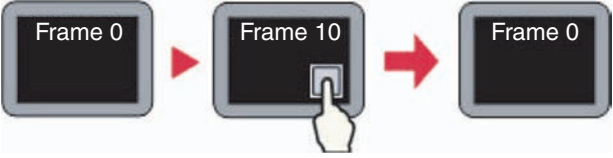
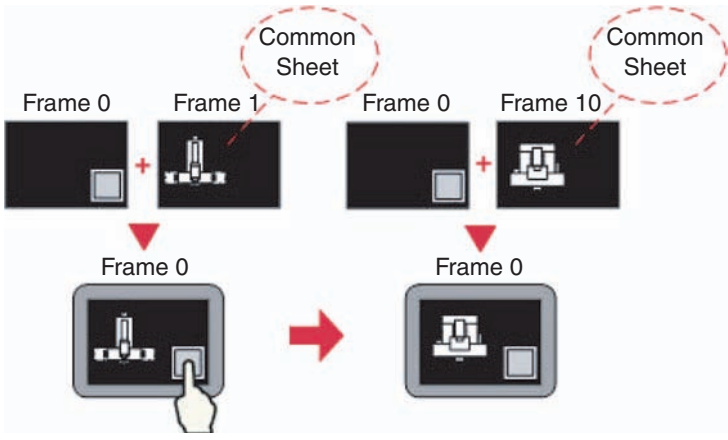
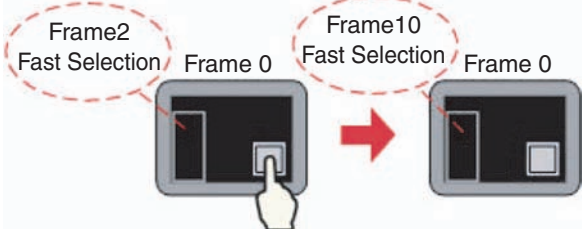
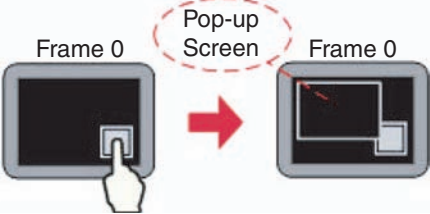
Descriptions of Switch Screen	
Change Screens	<p>Pressing the Function Key will make the current Base Screen including all of the pop-up screens closed and the Base Screen with the specified Screen No. will be switched to.</p> 
Backward	<p>Pressing the Function Key can make the current Base Screen closed and return to the latest opened Base Screen, which is effective only for the Base Screen. For example, when pressing the Function Key in "Frame 10" after "Frame 0" has switched to "Frame 10", "Frame 10" will be closed and the Screen will return to "Frame 0".</p> 
Change Common Sheet	<p>After the Function Key is pressed, the Common Sheet (Frame 1 is the system default screen.) can be replaced by the specified screen which will become the new Common Sheet.</p> 
Change Menu Screen	<p>After the Function Key is pressed, the Menu Screen (Frame 2 is the system default screen.) can be replaced by the specified screen which will become the new Menu Screen.</p> 
Pop-up Screen	<p>After the Function Key is pressed, the specified screen will pop up and be displayed above the current Base Screen, and the current screen will not be closed.</p> 

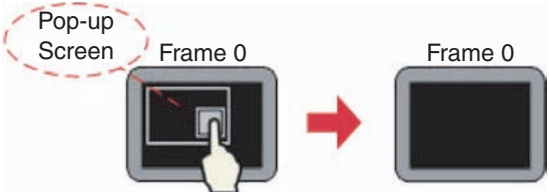
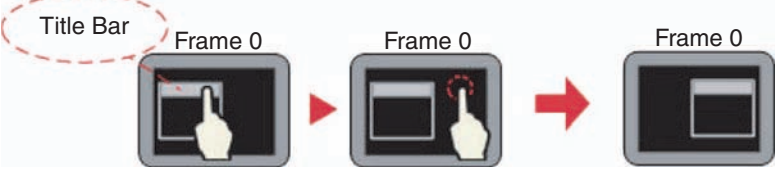
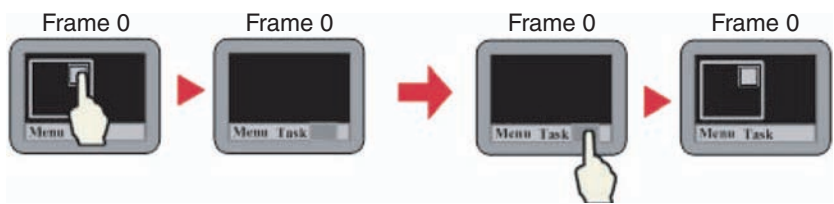
Descriptions of Switch Screen	
Close Screen	<p>Closing the Pop-up Screen which is displayed in the screen placed with a function key. The screen operations with the function do not perform write of the data for the address of control which is set by the Direct Screen or Indirect Screen. Therefore, make sure that point when the Direct Screen or Indirect Screen is used.</p> 
Title bar on Pop-up Screen	<p>Pressing the Function Key can move the Pop-up Screen to the specified position in the screen, which is effective for Pop-up Screen, Indirect Screen and Direct Screen.</p> 
Minimize	<p>After the Function Key is pressed, the Pop-up Screen will minimize to the Taskbar. Pressing this icon will make the screen return to its original position. This function is effective for Pop-up Screen, Indirect Screen and Direct Screen.</p> 

Example: Screen switching function

- (1) Create a new project and save it.
- (2) Create each of Fast select window 2, Common window 1, Basic window 4, Fast select window 5, Common window 6, Pop-up window 7. The Fast select window 2 and the Fast select window 5 are the same size ((100, 220) in this case) and the Pop-up window 7 is the smaller that other screens (it is ((200,150) in this case).
- (3) Create three function keys in the Fast select window 2. Three function keys such as [Change Screen] function key to switch to Basic window 0, [Change Screen] function key to switch Basic window 4, and [Change Menu Screen] function key to switch to Fast select window 5 to switch the Base Screen shown as below.

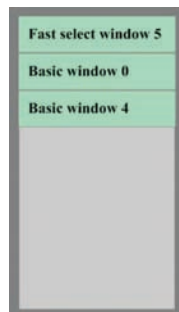

- (4) Place one text component displaying “Common window 1” displayed in Common window 1.

- (5) Place one text display component to display “Basic window 0” in the Basic window 0 as below. Also place [Pop-up Screen] function key to display “Pop-up window 7” and [Backward] function key in the Basic window 0.

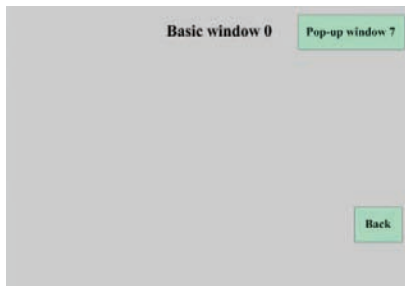

- (6) Place one Text Display component to display “Basic window 4” and [Backward] function key in the Basic window 4.
- (7) Create three Function Keys in the [Fast select window 5]. Three Function keys such as a [Change Common Sheet] Function Key to switch Common Sheet into Common window 1, a [Change Common Sheet] Function Key to switch Common Sheet into Common window 6, and [Change Menu Screen] Function Key to switch Menu Screen into Fast select window 2 as follows.



- (8) Place one Text Display component to display “Common window 6” in the Common window 6.
- (9) Place three Function Keys in “Pop-up Screen” in Pop-up window 7. Three Function Keys such as one [Title bar on Pop-up Screen] Function Key to display “Pop-up window 7”, a [Minimize] Function Key, and one [Close Screen] Function Key.
- (10)After the completion of setup, saving the project file and executing the off-line test after the compilation, the project is displayed as below.

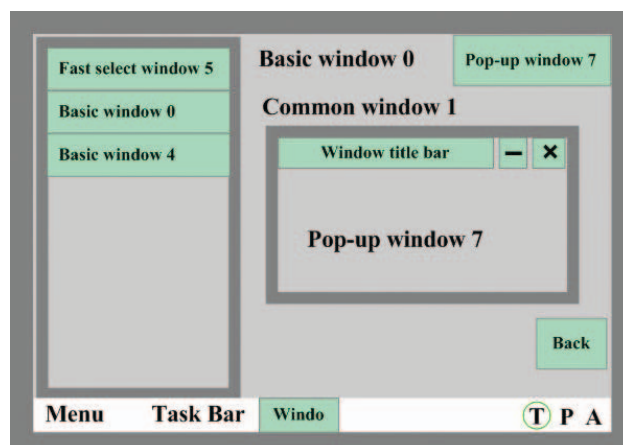
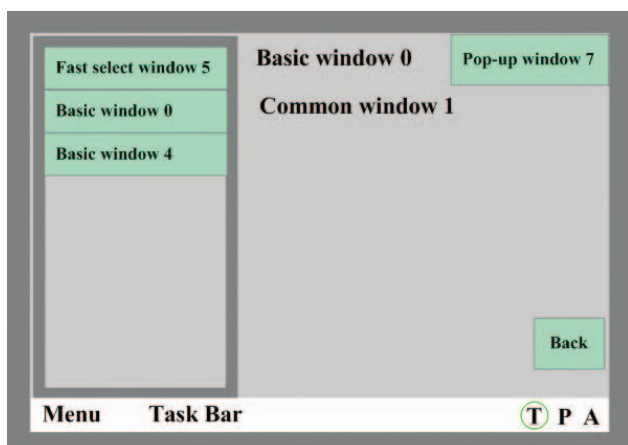

- (11)When switching the “Basic window 0” into “Basic window 4” by the button in Menu Screen, pressing “Back” button allows the screen returned to “Basic window 0” and then pressing “Back” button in the Basic window 0 allows the screen returned to “Basic window 4”.
- (12)When [Pop-up Screen] is pressed in “Basic window 0”, “Pop-up window 7” will pop up, as the upper right graphics shown.



(13) Pressing [Fast selection window 5] in Menu Screen will make the screen switch to Fast selection window 5, as shown below.

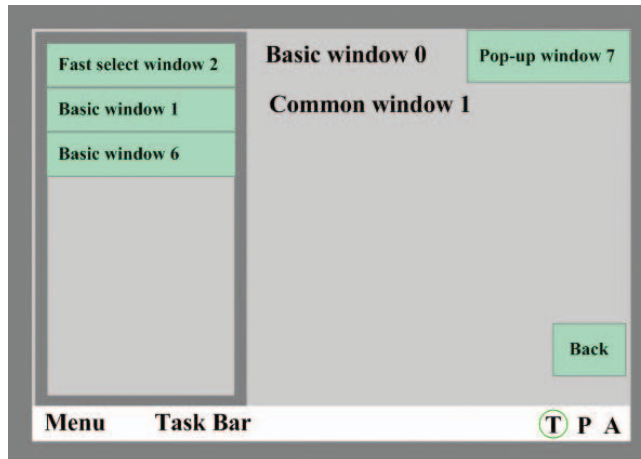

(14) Pressing [Common Sheet 1/6] can realized the switching among the Common Sheet.

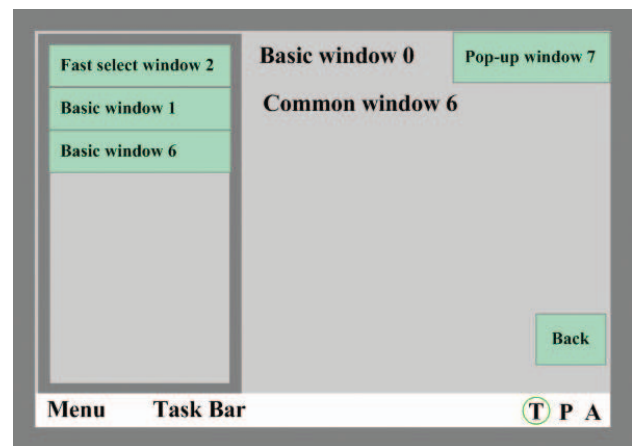
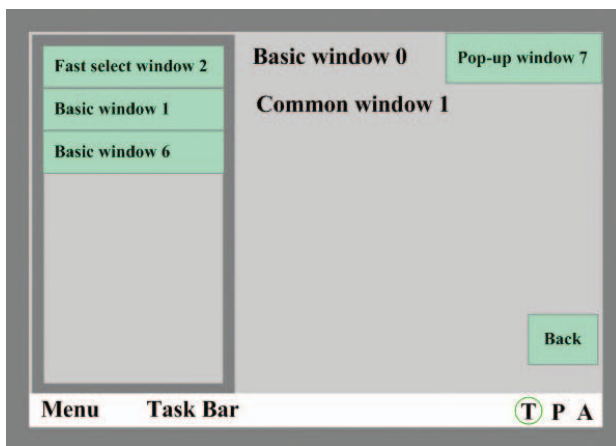

## 2 Keyboard Function

Descriptions of keyboard function	
Enter	Equivalent to the function of Enter key in the keyboard.
Back Space	When entering numbers or Text strings in the component [Number Input] or the component [Text Input] by Function Keys, remove one character which is placed immediately before the input cursor.
Clear	Clears the contents input to "Number Input" and "Text Input" components.
Escape	Cancels the input operation, equivalent to the function of Esc key in the keyboard.
Unicode	Sets the input characters including "0, 1, 2, ..." on the number keys, ASCII codes like a, b, c etc or Unicode characters for "Number Input" and "Text Input" components.
Cursor	Includes "Up", "Down", "Left", "Right", "Line head", "Line tail", "First position" and "Last position".
Select text	Includes "Start selecting" and "Finish selecting".
Text operation	Includes "Copy", "Cut" and "Paste".

**Example: Making NUM Keyboard**

Number (0 to 9) keys, Float, Minus sign, Enter, CLR and Backspace keys are required in the keyboard.

Step 1: Create a new project and make the layout of the NUM keyboard.

Firstly add the new screen “Frame 10” and open [Screen Property], then perform the screen operations such as setting the Width, Height and the border width to be 160, 200 and 2 respectively, setting the Frame Color, checking [Screen Attribute] and setting it to be “Keyboard page”. Finally divide Frame10 into three areas, i.e. Screen control area, Input Display area and Keyboard area, as shown below.

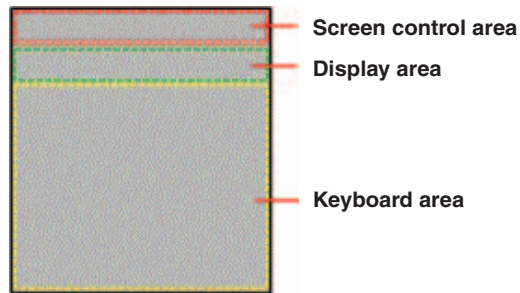

Step 2: Add the required components for the keyboard.

- (1) Firstly, add one Function Key as screen title bar into the Screen control area, in this case, select “Title bar on Pop-up Screen”.
- (2) Add two Text Display components for displaying the ranges of the maximum and the minimum for the Number Input, where the [Read Address] are LW9180 (LW9180 ~ LW9187 is the system special memory for displaying the maximum of Number Input) and LW9190 (LW9190 ~ LW9197 is the system special memory for displaying the minimum of Number Input) respectively and [Word Length] are both 6.
- (3) Add one Function Key to close keyboard screen, i.e. to check [Key Button] and select “Escape”.
- (4) Add one Text Display component to input display box in the Display area with [Read Address] set to LW9070 (LW9060 ~ LW9075 is the special memory which works as the buffer of Number Input or Text Display Input.) and [Word Length] set to 6.
- (5) Add twelve Function Keys as Character Input Keys in the Keyboard area. Take an example to input [1]: Select “Unicode” after selecting [Keyboard Function], then input “1” in Input area. And the operation for the other characters is similar to this operation.

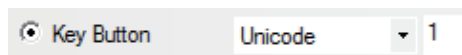

Add three Function Keys as the special keys, i.e. select “Clear”, “Backspace” and “Enter” respectively after selecting [Key Button] for the three Function Keys.

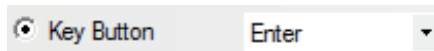

The final effects of the editing screen and the test are shown as the lower left and lower right graphics respectively.

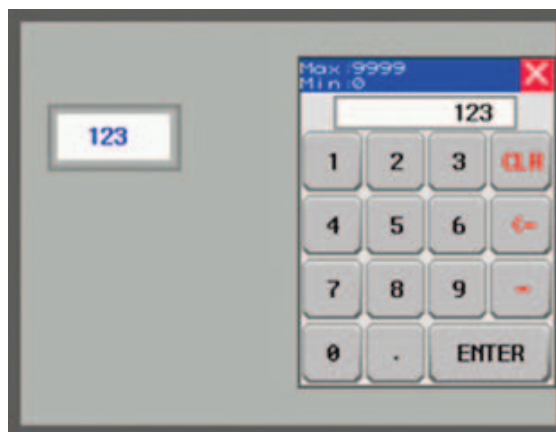

Example: Create Unicode keyboard by the combination of Text Input and Function Key.

The Unicode keyboard can be created by using [Unicode] option, which is available in the related Property screen of Text Display component, Text Input component and Note Book component, in combination with the [Key Button] - [Unicode] option in the Function Key Property.

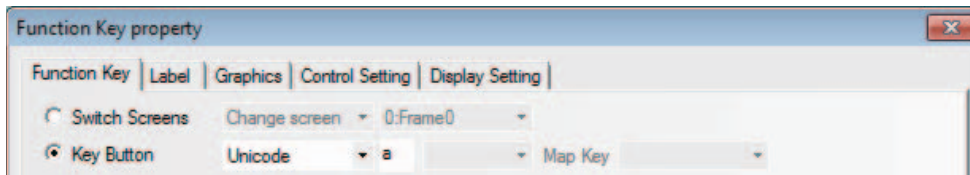
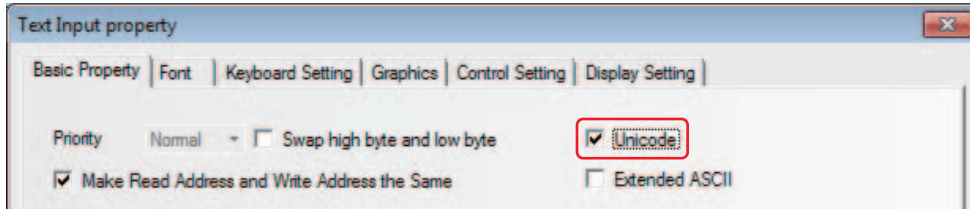

(1) Make the following settings after adding two Text Input components.

Properties	Text Input A	Text Input B
Unicode	Unicode	Unicode
Address	LW0	LW3
Word Length	3	3

(2) Add the Function Key and set the character to be input.

(3) Add one [Enter] key, i.e. select “[Key Button] - [Enter]” in the “Key Button” tab.

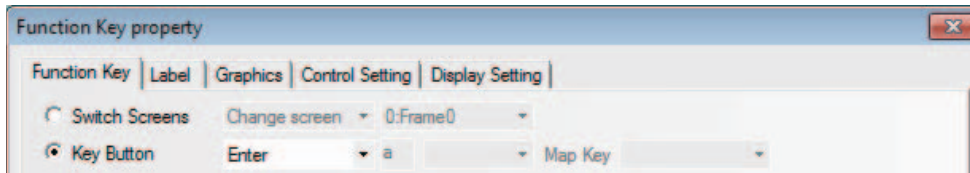

(4) The final effect is as shown below.

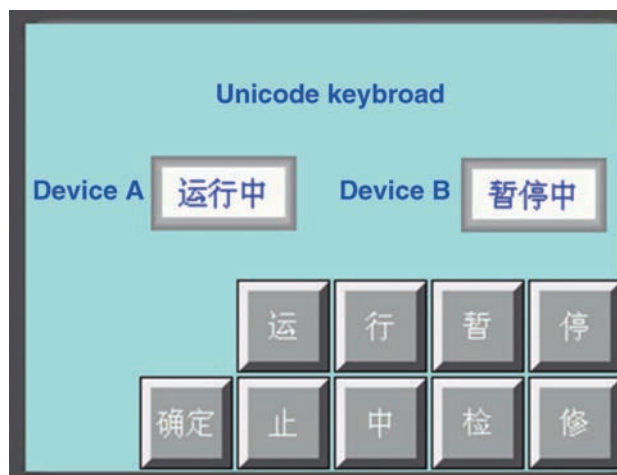

Unicode function currently only supports Chinese, English, Japanese and the common symbols.

**3** Execute Macro

After this function is selected, pressing the Function Key can execute the specified existing Macro code. (Refer to *3-9-3 Macro Triggering (Page 3-273)* in *NB-Designer Operation*)

**4** Touch Calibration

After this function is selected, pressing the Function Key can make the system go to PT Touch Calibration Screen, thus allowing the users to perform touch calibrations to the PT.

**5** Clear Event

After this function is selected, pressing the Function Key can clear the event information stored in the recipe memory.

**6** Notepad

Functions of Message Board		
Function	Pen	Pressing the Function Key means the current function is the pen in the Notepad.
	Eraser	Pressing the Function Key means the current function is the eraser in the Notepad.
	Clear Block	Pressing the Function Key can clear the contents in the area selected by the mouse of the Notepad.
Pen Color	For setting the pen color.	
Pen Size	For setting the pen size from the eight size available.	
Clear	Removing all the contents in the Notepad.	

For the procedures of operation method about the Notepad, refer to *3-7-7 Notepad (Page 3-220)* in *NB-Designer Operation*.

● **There are four methods to clear the event information:**

- (a) By clicking the [Function Key] component to clear the event information after the [Clear Event] option in [Function Key] tab in Function Key Property dialog box being checked. The event information data stored in the recipe memory can be cleared by this method.
- (b) By restarting the PT to clear the event information after the value of special system memory LW10015 being set to 0. The event information data stored in the recipe memory can be cleared by this method.
- (c) Check in the [Clear Event History] option in [NBManager] dialog box and execute the download, the event information will be cleared. The event information data stored in the recipe memory and the event information files stored in the external memory can be cleared simultaneously by this method.
- (d) Check in the [Clear Event History] option in the NBDownload dialog box and execute the download again. The event information data stored in the recipe memory and the event information files stored in the external memory can be cleared simultaneously by this method, as shown below:

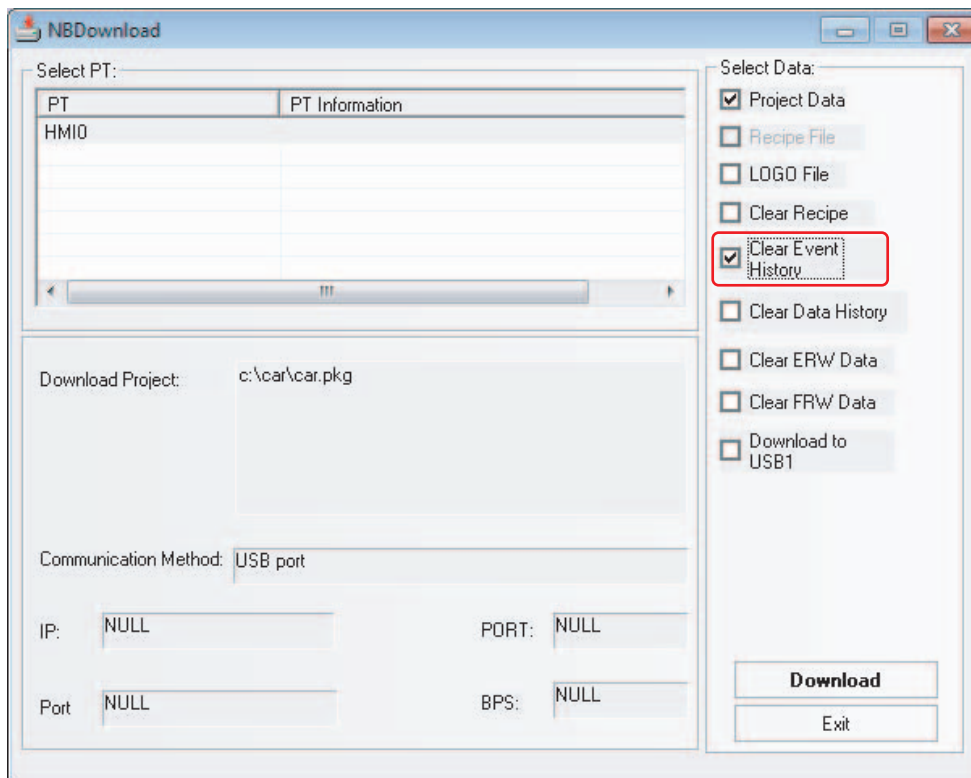

### 3-7-3 Alarm Display



Alarm Display icon can be used to display the triggered preset alarm information by using the Neon Lamp in the area where the Alarm Display locates. The alarm information must be related to node address of a certain bit, and it will scroll from the right to the left when the bit address is triggered to the alarm state. The alarm information will continue to scroll until this bit address is switched to the non-alarm state. The alarm information must be logged in the [Alarm Setting] database in advance. (This component only displays the alarm information, and the component to be displayed must be logged in the [Alarm Setting] database).

## ● Process of adding one Alarm Display

- 1 Press the Alarm Display icon, drag it to the screen, then the [Alarm Display Property] dialog box will pop up.

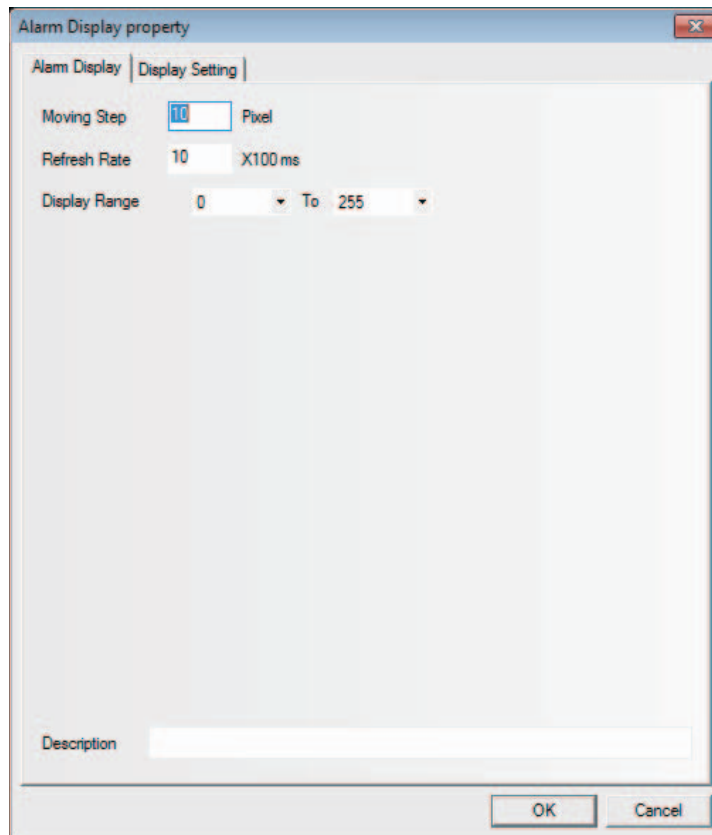

**Moving Step:** Set the Moving Step in the unit of pixel. The larger the number of moving step, the faster the speed of scroll display. The value is between 1 and 255.

**Refresh Rate:** Refers to the interval of each movement with the unit of 100 ms. The larger the value of moving speed, the slower the speed of scroll display. The value is between 1 and 10000 (i.e. 0.1 s to 1000 s).

**Display Range:** Set the range of alarm types to be displayed between 0 to 255. Restricting the alarm types at this moment allows the display only optional alarm information.

**Description:** The descriptions can be entered to explain the Alarm Display components (the descriptions will not be displayed in PT screen.).

- 2 Press the [OK] button to complete the setup.

● Example of creating one Alarm Display component

- 1 Create a new project firstly.
- 2 Click the [Alarm Setting] icon in [Project Database] to display the logon list of alarm setting, and then add two pieces of alarm setting, as shown below.

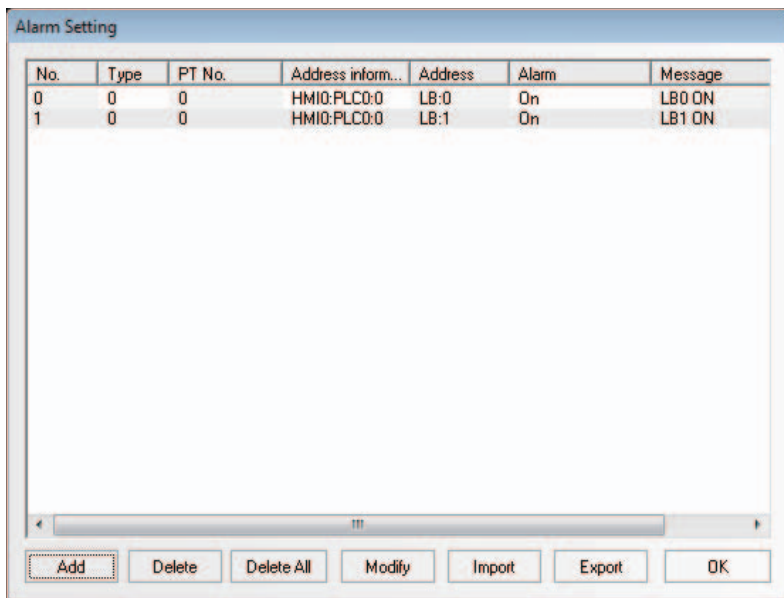

- 3 Add one Alarm Display component in Frame 0.

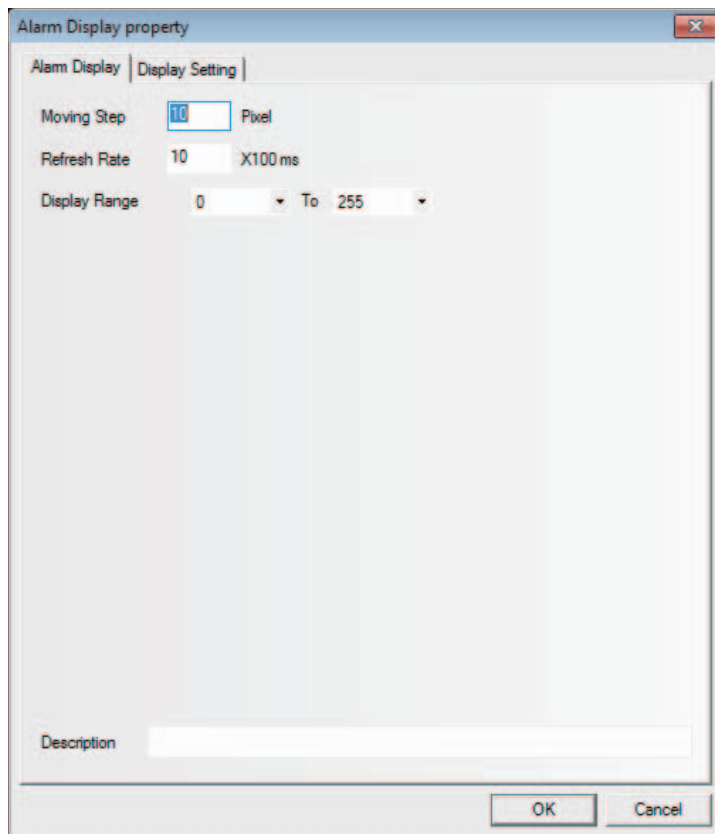

- 4** Add two Bit Switches to control the ON/OFF of LB0 and LB1 respectively, then switch the ON/OFF state of the LB0 and LB1, the alarm setting which was registered by the procedure 2 can be switched between display and non-display by the alarm display.

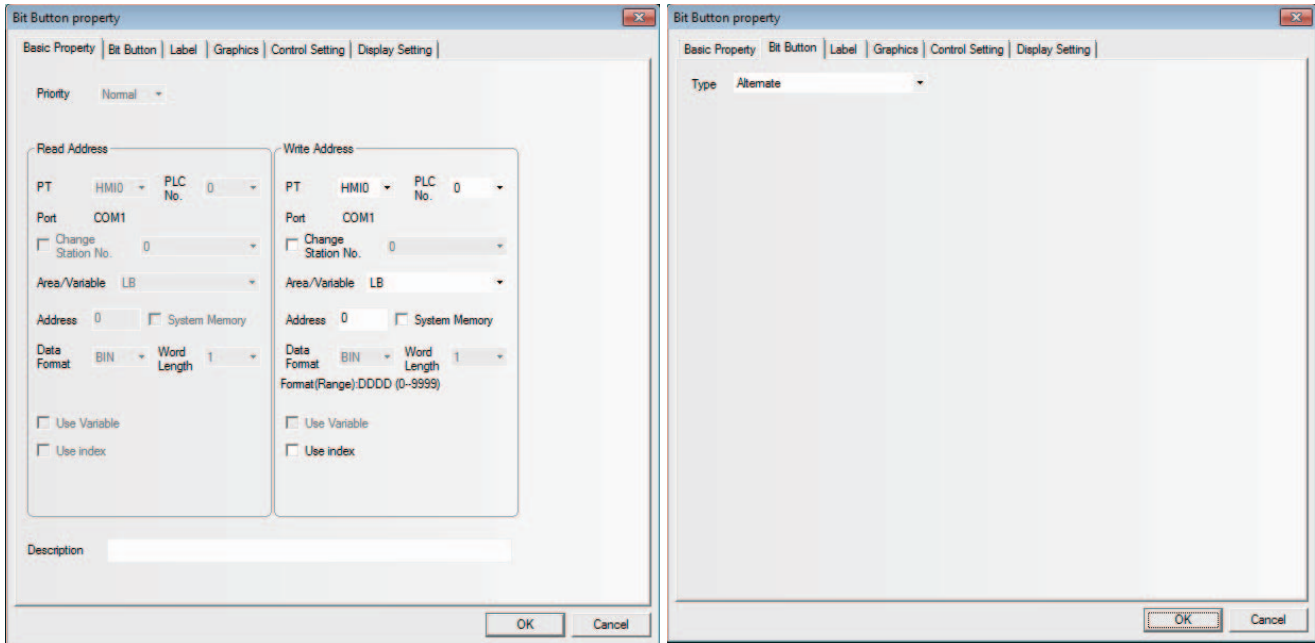

- 5** When saving the project files and executing the offline test after the compilation, the result will be displayed as follows.

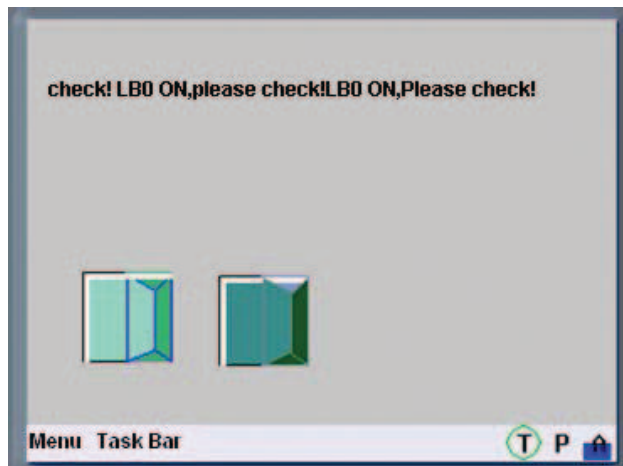



## 3-7-4 Timer



Timer is a kind of component performing the timing. When the timing is over, it will play the other corresponding functions such as periodical Macro instruction execution, parameter setting and data transmission etc.

### ● Process of adding the Timer

- 1 First press the Timer icon before dragging it into the screen, and go to [Timer] tab after the [Timer Property] dialog box pops up.

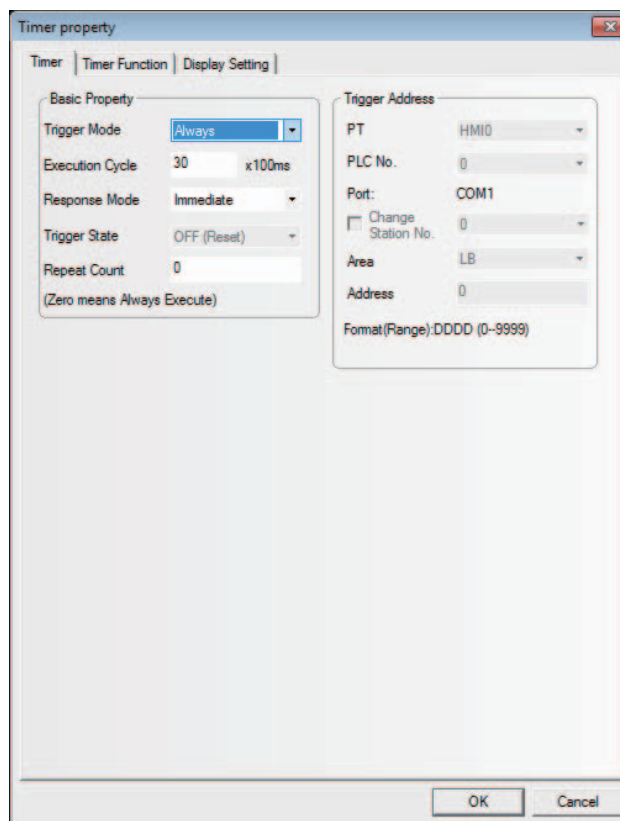

#### Descriptions of Timer Properties

Trigger Mode	Always	With this triggering mode, the timer will be triggered once it is initialized. The timer will be operated when displaying the screen in the timer was loaded to, and the timer will be stopped automatically and will not be triggered any more when the number of the timer trigger operations reaches to the value specified at "Repeat Count".
	When screen is loading	The timer will be operated when the timer is placed in the screen and the number of the timer trigger operations it will stop automatically after the value set in "Repeat Count" being reached, and will not be triggered any more. The effect of this function is almost the same as that of "All time".
	When screen is unloading	Function operation will be triggered once when the screen where the timer component locates is closed.

Descriptions of Timer Properties		
Trigger Mode	Trigger Address	When the address specified at [Trigger Address] matches to the status specified at [Trigger State], the triggering operates. If [Repeat Count] is set to "0", the triggering operation is consecutively repeated until the trigger condition is released. After the trigger condition is cleared once, followed by the trigger is operated for the number of times specified at [Repeat Count], the timer will be stopped automatically.
Execution Cycle	It refers to the timing cycle of the timer with the unit of 100 ms. The timer will perform functional operation once at each interval of timing cycle.	
Response Mode	Immediate	When the triggering condition is met, the function will be executed immediately.
	Delay	When the triggering condition is met, the function will be executed after one cycle is delayed.
Trigger State	When "Trigger Address" is selected, the triggering state of the memory is On or Off.	
Repeat Count	It refers to the times of repeated execution after the timer is triggered. When it is "0", the function will always be executed.	
Trigger Address	After "Trigger Address" is selected, it needs to specify the address to be the trigger.	

## 2 Switch to the [Timer Function] tab:

**Execute Macro:** The Macro code to be executed for each timing reached to the time set by the executing cycle. (Refer to *3-9-3 Macro Triggering (Page 3-273)* in *NB-Designer Operation*)

**Data Transmission:** The data transmission will be performed. The data will be transformed from the specified addresses as ([Source Data]) to the specified addresses as ([Destination Address]) for each timing reached to the time set by the executing cycle.

**Source Address:** Refers to the starting address that the data will be transferred from.

**Destination Address:** Refers to the starting destination address that the data will be transferred to.

**Memory Type:** Used to select among "Word" or "Bit" for the memory type to be transmitted.

**Data Length:** Refers to the length of the data to be transferred.

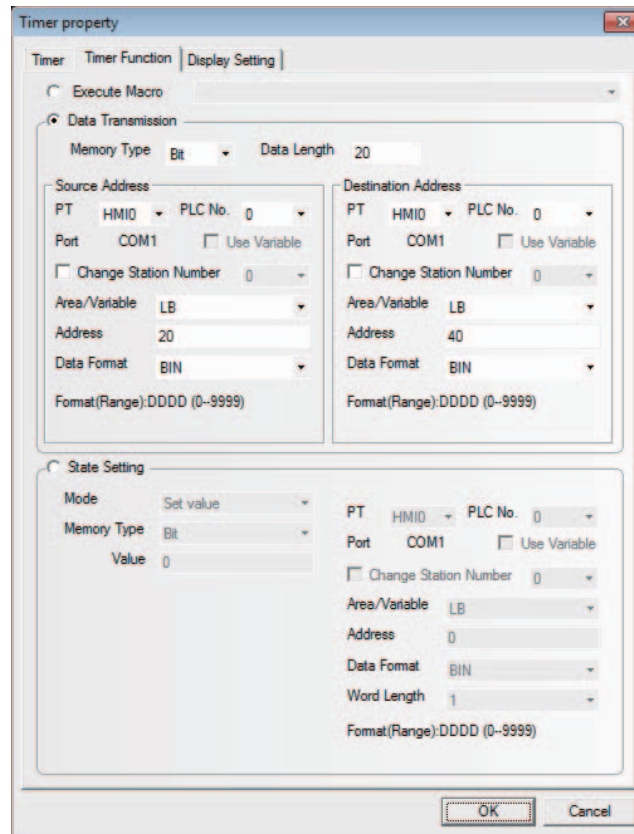

**State Setting:** After the time set at Execution cycle passed, when the value is written to the bit address or word address, select the parameter.

**Set Address:** After the time which was set at Execution cycle passed, specify the bit address or word address to be written.

- (a) Bit Address Setting ([Memory Type] is specified to [Bit]):

Mode: Includes Set value, Periodic Toggle, as shown below.

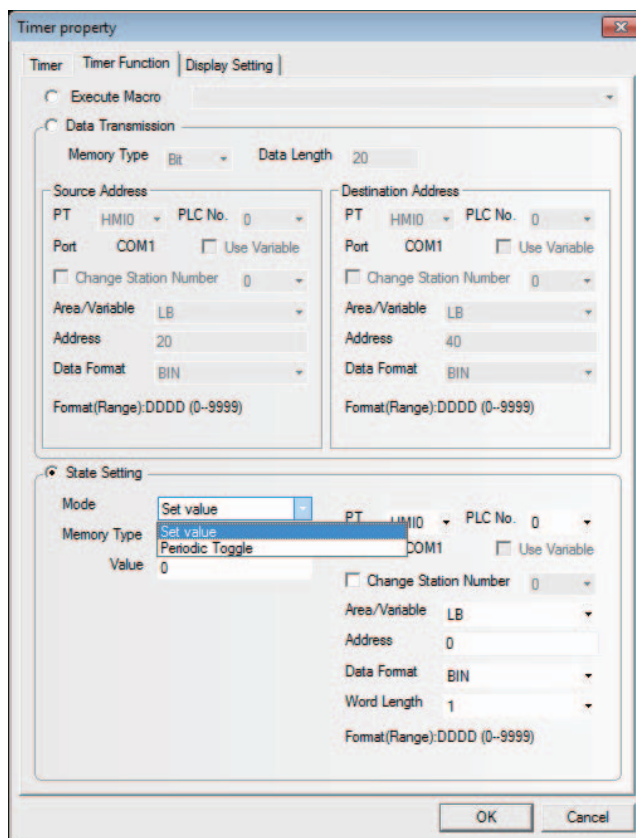

The detailed description of each function is as follows.

Mode	Descriptions
Set Value	After the time which was set at Execution cycle passed, specify the value of the bit address to "0" or "1".
Periodic Toggle	After the time which was set at Execution cycle passed, switch the value of the bit address "0" with "1"

(b) Word Address Setting([Memory Type] is set to [Word]):

Mode: Periodic JOG++(loop), Periodic JOG--(one way), Periodic Bounce(repeating after reaching), Step up(loop), Step Down(loop), Constant Setting, and Periodic JOG++(one-way) as shown below.

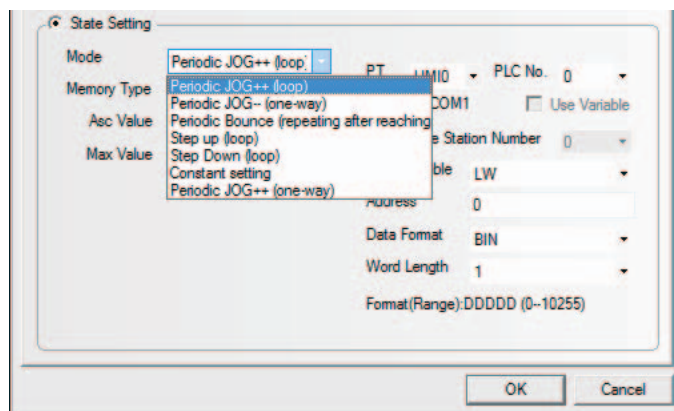

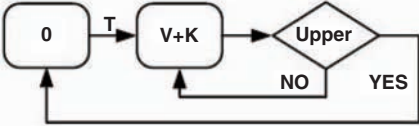
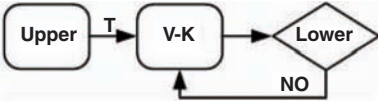
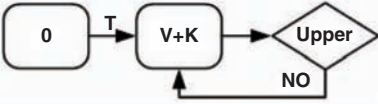
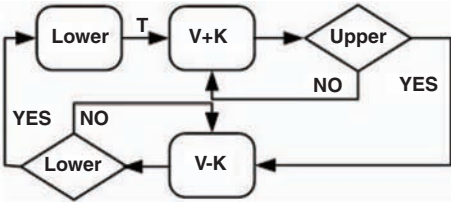
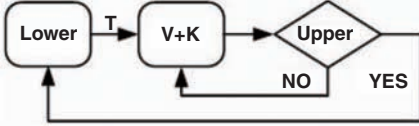
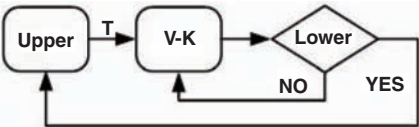
Mode	Descriptions
Periodic JOG++(loop)	This mode makes the address value of the memory for the specified word increase automatically by the “increment” at the interval of each “Execution Cycle” and makes it return 0 again when “the upper limit value” is reached. 
Periodic JOG--(one-way)	This mode makes the address value of the memory for the specified word decrease automatically by the “decrement” at the interval of each “Execution Cycle” and makes it stop at the lower limit value after “the lower limit value” is reached. 
Periodic JOG++(one-way)	This mode makes the address value of the memory for the specified word increase automatically by the “increment” at the interval of each “Execution Cycle” and makes it stop at the upper limit value after “the upper limit value” is reached. 
Periodic Bounce (repeating after reaching)	This mode makes the address value of the memory for the specified word increase automatically by the “step” at the interval of each “Execution Cycle” until to “the upper limit value”, and then makes it decrease by the “step” at the interval of “Execution Cycle” until to the “lower limit value”, and later makes it increase again, thus making the cycle repeated again and again. 
Step up (loop)	This mode makes the address value of the memory for the specified word increase automatically by the “step” at the interval of each “Execution Cycle” until to “the upper limit value”, and makes it increase again after being reset to “the lower limit value”. 
Step down (loop)	This mode makes the address value of the memory for the specified word decrease automatically by the “step” at the interval of each “Execution Cycle” until to “the lower limit value”, and makes it decrease again after being reset to “the upper limit value”. 
Constant Setting	The preset constant value will be written to the address of the memory for the specified word after the “Execution Cycle” is reached.

### 3-7-5 Bitmap



**Bitmap** Bitmap component is used to call and display the bg-form graphics registered in the system graphics library or the graphics library in Project File Window. Bitmap component is not controlled by the memory, and doesn't have multiple states, thus the bitmap corresponding to the graphics state specified by you at the designing time will always be displayed. For the creation and usage of bitmap, refer to [3-5-6 Bitmap].

- 1** First press the Bitmap icon, drag it to the screen, then select the bitmap you want to use, as shown below.

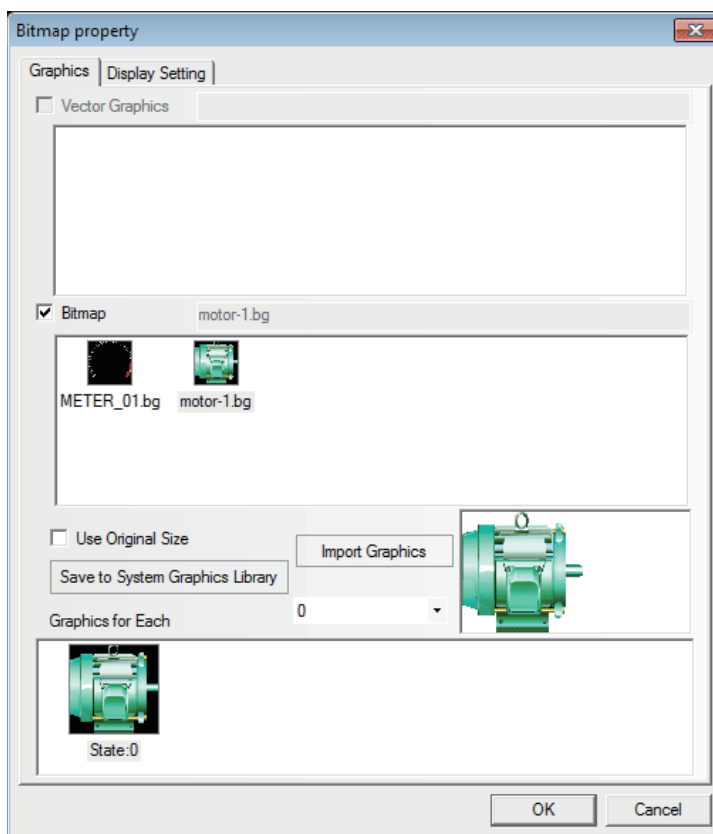

- 2** Press the [OK] button, and then adjust the position and the size of the Bitmap in the screen, as shown below:



### 3-7-6 Vector Graphics

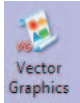

Vector Graphics component is used to call and display the vg-form graphics registered in the system graphics library or the graphics library in Project File Window. The Vector Graphics component is not controlled by the memory, and doesn't have multiple states, thus the Vector Graphics corresponding to the graphics state specified by you at the designing time will always be displayed. For the creation and usage of Vector Graphics, refer to [3-5-5 Vector Graphic].

- 1 Press the Vector Graphics icon, drag it to the screen, then select the Vector Graphics you want to use, as shown below.

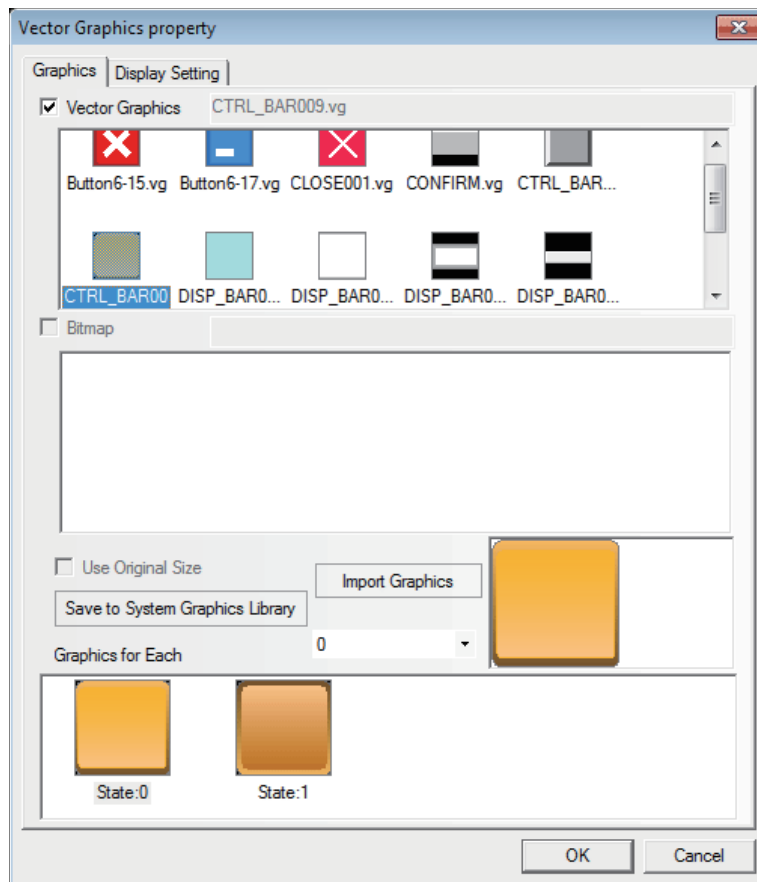

- 2 Press the [OK] button, and then adjust the position and the size of the Vector Graphics in the screen, as shown below:

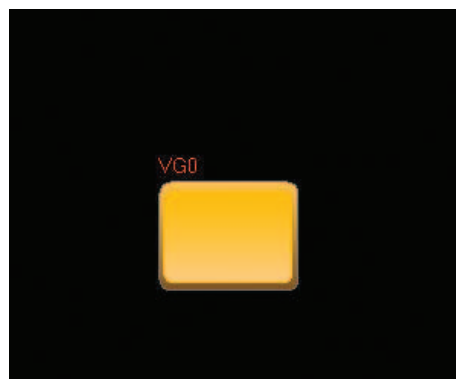

### 3-7-7 Notepad

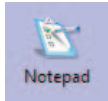

Notepad is designed specially to provide the users with a space for the message reservation and transmission, thus allowing the users to write any text on the PT freely. And its function is similar to that of the drawing board.

#### ● Process of adding Notepad

- 1 Press the Notepad icon, drag it to the screen, then the [Notepad Property] dialog box will pop up.

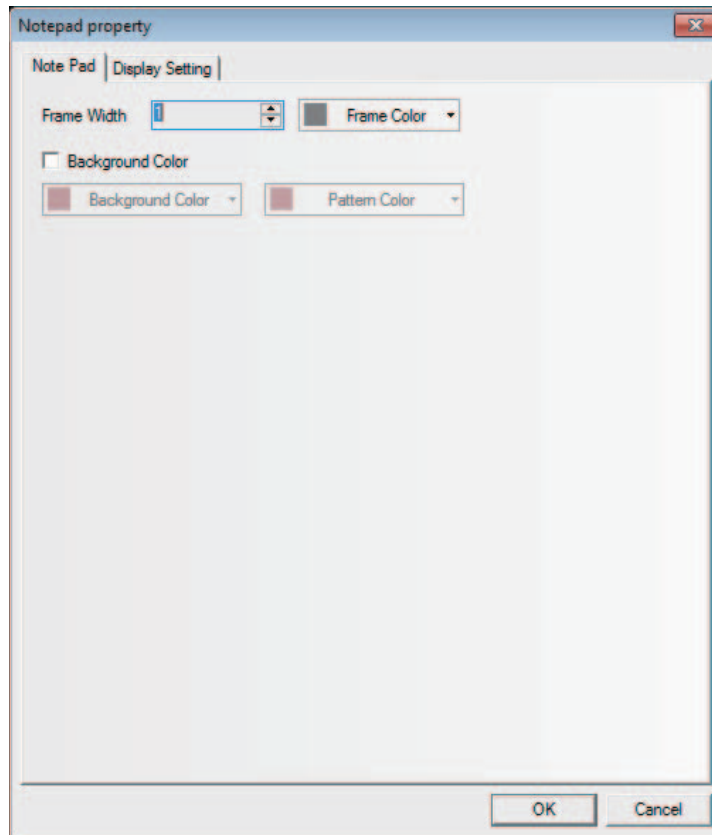

**Frame Width:** Refers to the frame width of the Notepad.

**Background Color:** Selects the Background Color and Pattern Color.

- 2 Press the [OK] button to complete the setup, and adjust the position and size of the Notepad component.



### ● The combined use of Notepad with Function Keys

After the Notepad is placed well, you can set the Function, Pen Color, Pen Size and Clear after the [Notepad] is selected in the Function Key tab, as shown below.

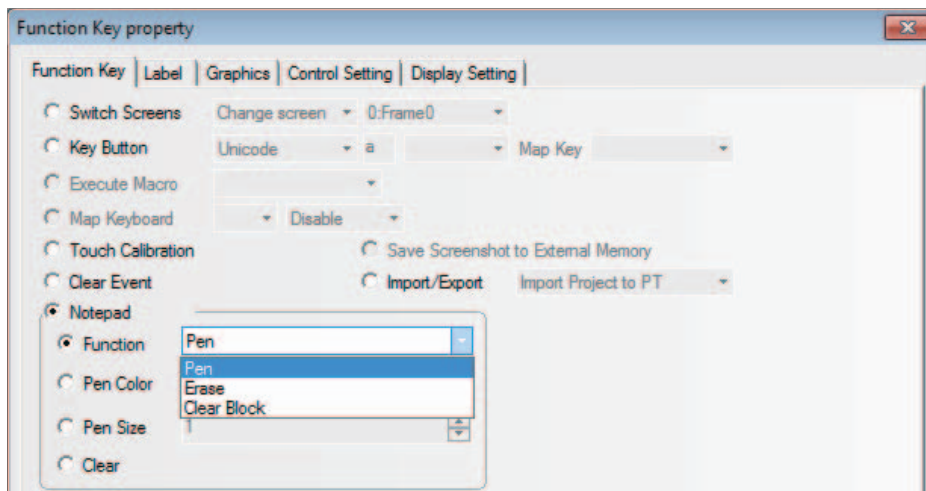

(a) Function

**Pen:** After selecting the pen, you can leave messages or make drawings in the Notepad.

**Eraser:** Clears the contents in the Notepad.

**Clear Block:** Clears the contents in the selected area of the Notepad.

(b) Pen Color: Sets the pen color, as shown below.

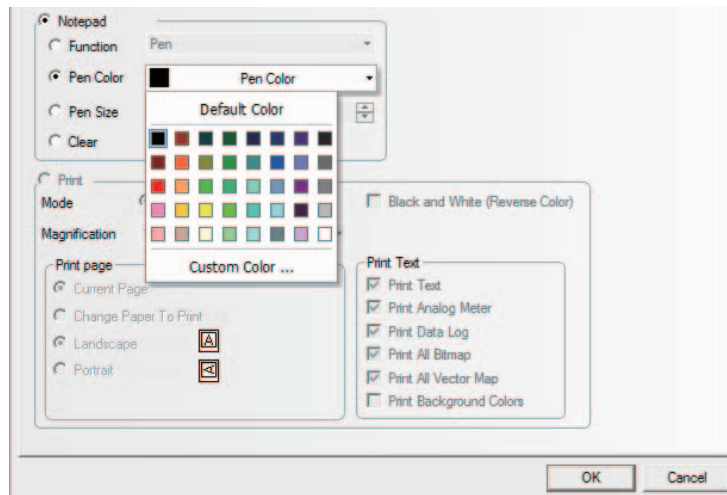

(c) Pen Size: Sets the thickness of pen from the available 1 (the thinnest) to 8 (the thickest), as shown below.

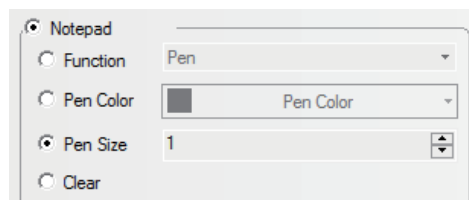

(d) Clear: Clears the contents in the whole Notepad.

## ● Create a Notepad

- 1 Makes Frame 0 as the Note pad screen. Of course you can make the other screen as the Note pad screen. And later you just need to drag the Notepad component to the screen.

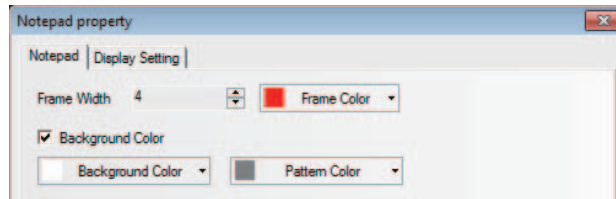

- 2 Firstly set the Properties of the Notepad component, as shown below.

Frame Width: Select 4 here from the range of 1 to 16.

Frame Color, Background Color and Pattern Color: Select the colors you want to use here.

- 3 Then adjust the screen to the required size, as shown below.

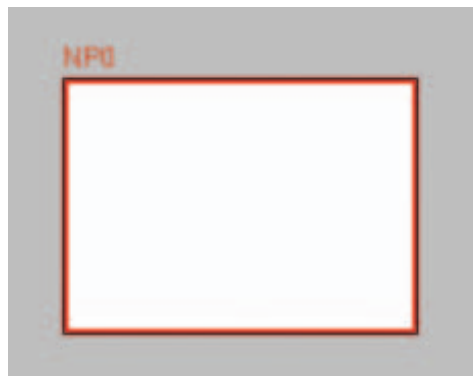

- 4 Later add several Function Keys in the left and bottom of the Notepad component respectively, i.e. select Function Keys FK0, FK1, FK2 and FK3 to be as Pen, Eraser, Clear Block and Clear Screen respectively, select the Function Keys FK4, FK5, and FK6 to be the Pen Colors of Red, Green and Blue respectively, and select the Function Keys FK7, FK8, FK9 and FK10 to be the Pen Sizes of 2, 4, 6 and 8 respectively, as shown below:

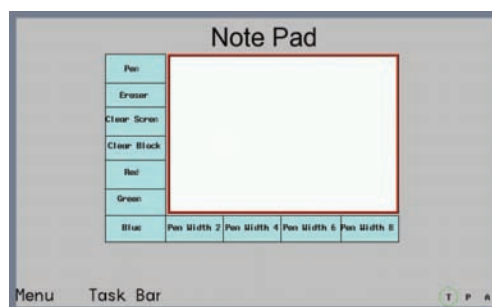

- 5** [Save] and [Compile] the project files and execute [Offline Test] and result in the display as follows.

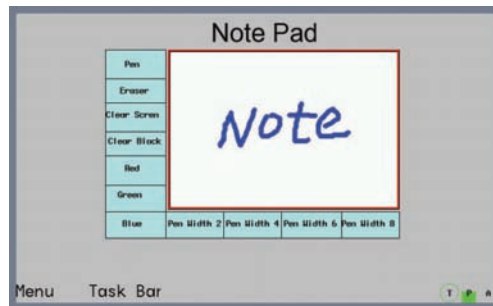

The system reserves the following areas for the system memory:

- LB9020 to LB9032: [Pen], [Eraser], [Clear Block],
- LB9030 to LB9032: pen size,
- LW9006 : operation mode of Notepad,
- LW9007 : pen size
- LW9008 : color of pen selecting among 256 colors.

For the details, refer to *3-11 Address of System Memory (Page 3-328)* in *NB-Designer Operation*.

- Note 1** Each PT can only use one Notepad component. If there are more than one Notepad components, an error occurs at the compilation.
- 2** The data in the Notepad will not be saved, i.e. be lost, when the power of PT is OFF.

### 3-7-8 Data Transmission



Data Transmission component can make the data in the specified memory address transferred to the other memory address. Data Transmission can be triggered by the manual touching method or the state change of the specified address.

## ● Process of adding Data Transmission

- 1 Drag the Data Transmission icon to the screen after it being pressed, then the [Data Transmission Property] dialog box will pop up.

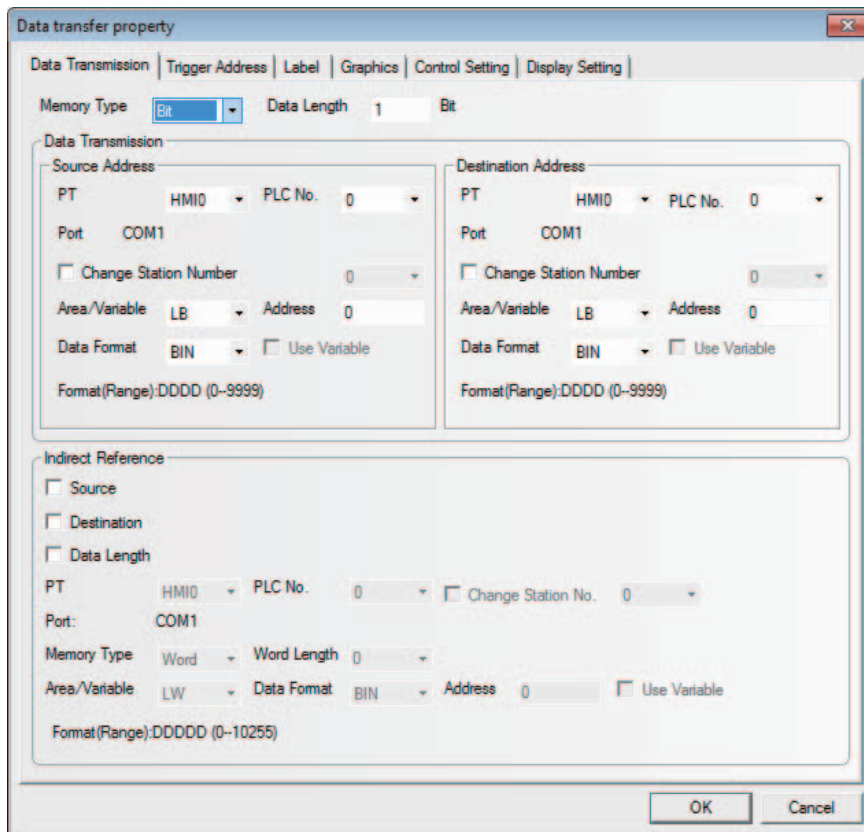

**Memory Type:** The Memory Type which is transmitted should be selected among [Bit] (bit data) or [Word] (word data).

**Data Length:** The number of data transferred by the Data Transmission component. When the Memory Type is Bit or Word, the units are “bit” or “word” respectively. A maximum 2000 partitions of data can be specified.

**Source Address:** Sets the source address of the transferred data.

**Destination Address:** Sets the destination address of the data transmission.

**Indirect Reference:** Set this parameter when setting indirectly the source address, destination address, and data length.

Take the following settings as example, i.e. the source address, destination address and data length use the Indirect Reference.

After setting the source address type to “D memory” and making the source address offset controlled by the LW100, set the destination address type to “LW memory” and make the destination address offset and the data length controlled by the LW101 and LW102 respectively.

**Source address is 0, destination address is 0, data length is 1:**

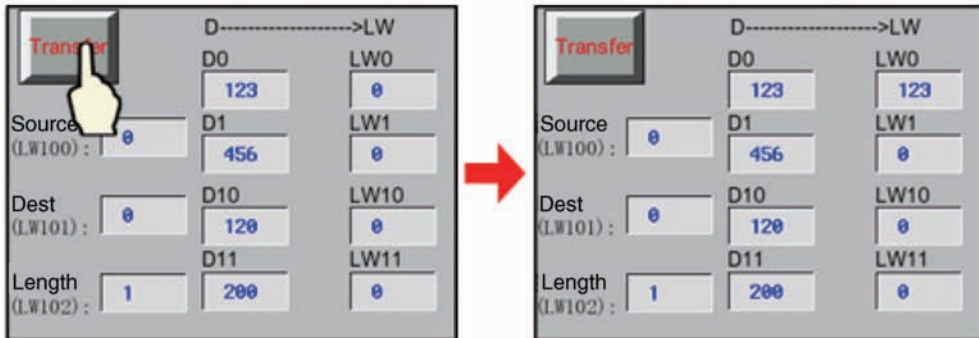

**Source address is 10, destination address is 10, data length is 2:**

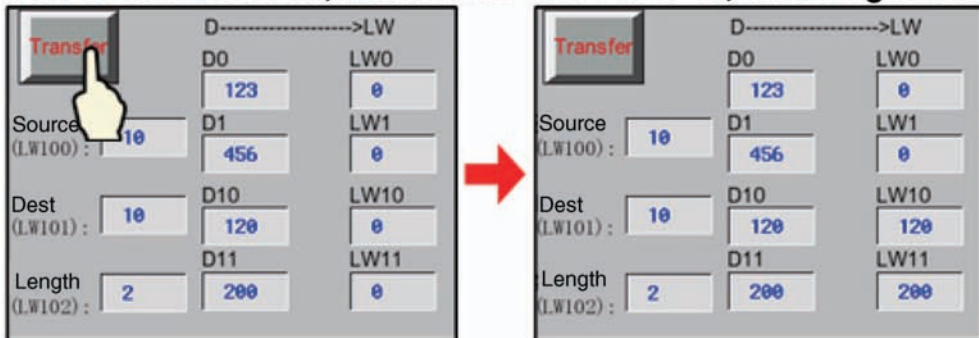

**2** Set the [Trigger Address].

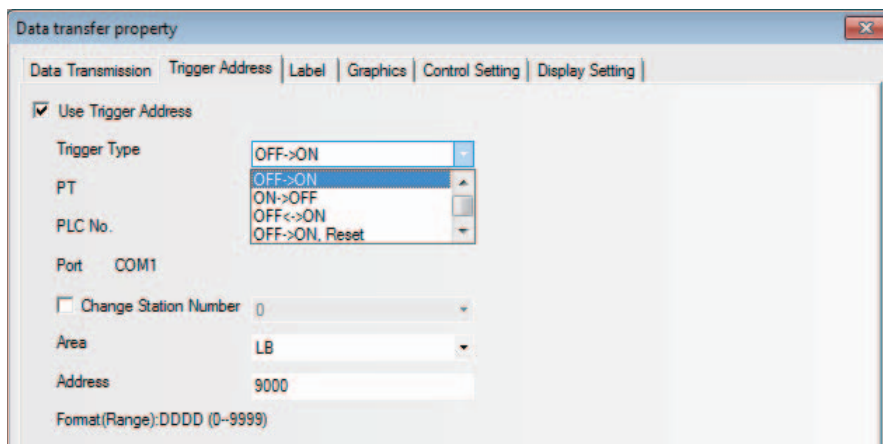

Trigger Type	Descriptions
OFF→ON	When the state of the specified address is switched from OFF to ON, the Data Transmission component will be triggered to perform the transmission.
ON→OFF	When the state of the specified address is switched from ON to OFF, the Data Transmission component will be triggered to perform the transmission.
OFF↔ON	When the state of the specified address is changed, the Data Transmission component will be triggered to perform the transmission.
OFF→ON, Reset	When the state of the specified address is switched from OFF to ON, the Data Transmission component will be triggered to perform the transmission. At the same time with the transmission, the specified address will be turned OFF.
ON→OFF, Reset	When the state of the specified address is switched from ON to OFF, the Data Transmission component will be triggered to perform the transmission. At the same time with the transmission, the specified address will be turned ON.

- 3** Make settings in the [Label], [Graphics] and [Control Setting] tabs by using the similar method for the components mentioned above.
- 4** Press the [OK] button to complete the setup, and adjust the position and size of the Data Transmission component.

### 3-7-9 Freeplotting



The Freeplotting component is based on the data in the memory, and you can use it to draw the corresponding graphics by the pixel point in the PT.

#### ● Freeplotting Component Property

- 1** When selecting [Solid Color] for the Type (drawing graphics using the bit memory)

Set the component size to 50×50, the memory address to LB0, the pattern color to red and the values of 2500 memories (i.e. LB0 to LB2499) to be read by PT. Then when the memory value is 1, the pixel point of the component corresponding to the communication address which stored the values will be applied by red color.

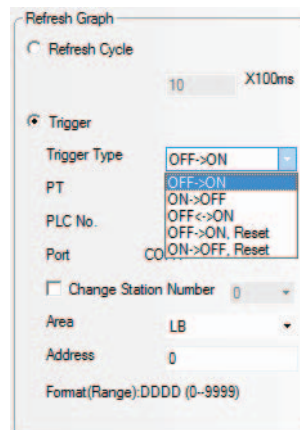
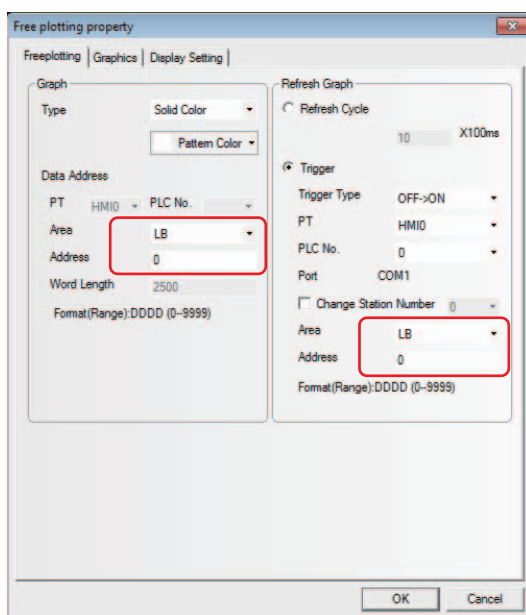

## 2 Multicolor is selected for Type (Draw graphics using word memory.).

Set the component size to 50×50, the memory address to LW0, and the values of 2500 memories (i.e. LW0 to LW2499) to be read by PT. Then the pixel point of the component corresponding to the communication address which stored the values will be drawn into the corresponding 65536 true color according to the actual value read from the memory.

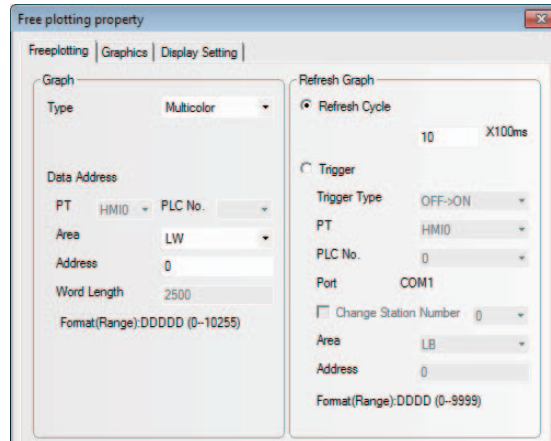

## 3 There are two refreshing methods for the components.

**Refresh Cycle:** The graphics are updated at a certain period. The minimum unit to update the graphics can be set at 100ms.

**Trigger:** When the status of the bit address specified with [Trigger] matches to the condition specified with [Trigger Type], the graphics are updated.

### 3-7-10 Date/Time

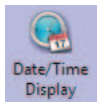

Date/Time Display

The Date/Time component can display the value of the internal RTC clock of the PT in the set format.

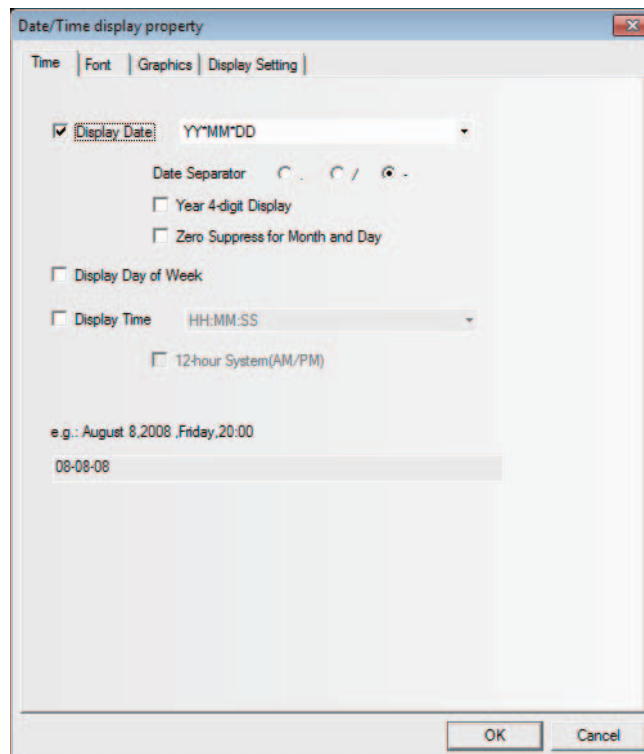

### ● Date/Time Component Property

Descriptions of Date/Time Component Property		
Display Date	Sets whether to display the date or not.	
	Date Format	There are four formats available, where DD, MM and YY refer to the date, month and year respectively.
	Date Separator	Three formats are available. (e.g. 2011.06.24)
	Year 4-digit Display	Displays 4-digit included in the year after this option being selected. For example: "2011 Year" will be displayed as "2011" or "11" after this option is checked or not checked respectively.
	Zero Suppress for Month and Day	Clears zero included in the date and month after this option being selected. For example: "June" will be displayed as "6" or "06" after this option is checked or not checked respectively.
Display Day of Week	Sets whether to display the week or not.	
Display Time	Sets whether to display the time or not.	
	Time Format	There are 2 formats available, where HH, MM and SS refer to the hour, minute and second respectively.
	12-hour System(AM/PM)	The time will be displayed in 12-hour format after this option is checked. For example: "3 PM" will be displayed as "3:00 PM" or "15:00" when this option is checked or not checked respectively.

The Date/Time component can only read the time of the internal RTC of the PT, but not modify the time. If the time of the internal RTC of the PT needs to be modified, you can calibrate the system time by using the system setup screen of the PT or modifying the values of system special memories LW10000 to LW10006.



## 3-7-11 Indirect Shape



The Indirect Shape component can modify the positions and sizes of the rectangle, ellipse or line by changing the value of the memory.

### ● Indirect Shape Properties

#### 1 Indirect Shape tab

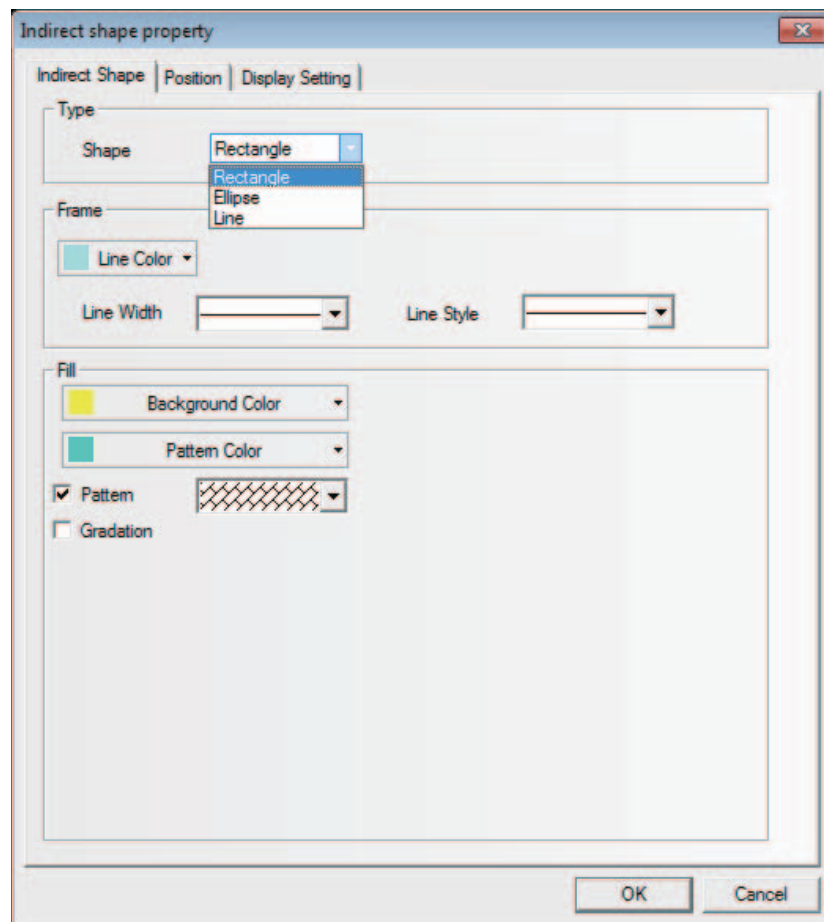

**Type:** Sets the shape type from the available types of the Rectangle, Ellipse and Line.

**Frame/Line:** Sets the Line Color, Line Width and Line Style for the rectangle and ellipse, and line.

**Fill:** Sets the fill color and the fill style for the rectangle and ellipse.

## 2 Position

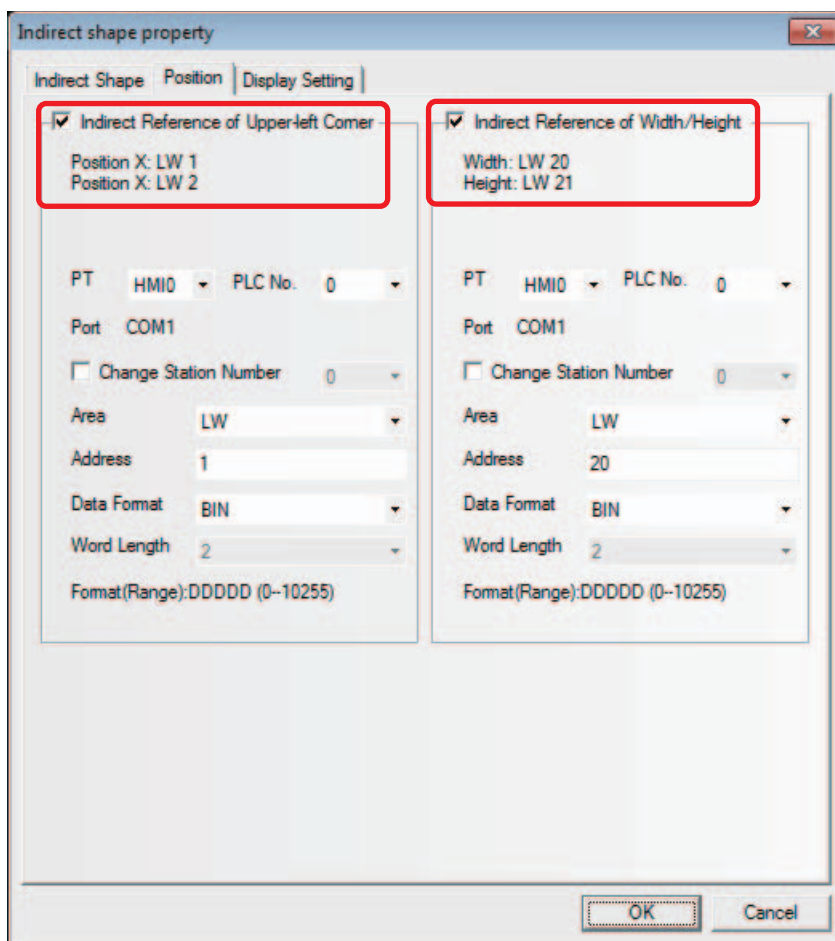

The descriptions of the specific Properties are as follows:

Indirect Reference of Upper-left Corner	Unchecked	Position X and Position Y of the Indirect Shapeics are the constants.
	Checked	Position X and Position Y of the Indirect Shapeics are the indirect reference. Position X = First address of the set memory, Position Y = First address of the set memory + 1
Indirect Reference of Width/Hight	Unchecked	The Width and Height of the Indirect Shapeics are the constants.
	Checked	The Width and Height of the Indirect Shapeics are the indirect reference. Width = First address of the set memory, Height = First address of the set memory + 1

Example of creating Indirect Shape

**1** Set and place Indirect Shape (ellipse) components as follows:

- [Shape] : Ellipse
- top address of [Indirect Reference of Upper-left Corner] : LW0
- top address of [Indirect Reference of Width/Height] : LW2

Storing the values as follows, the effect is shown as below:

- LW0 (Coordinate position of X in upper-left corner) : 0
- LW1 (Coordinate position of Y in upper-left corner) : 0
- LW2 (Width) : 100
- LW3 (Height) : 100

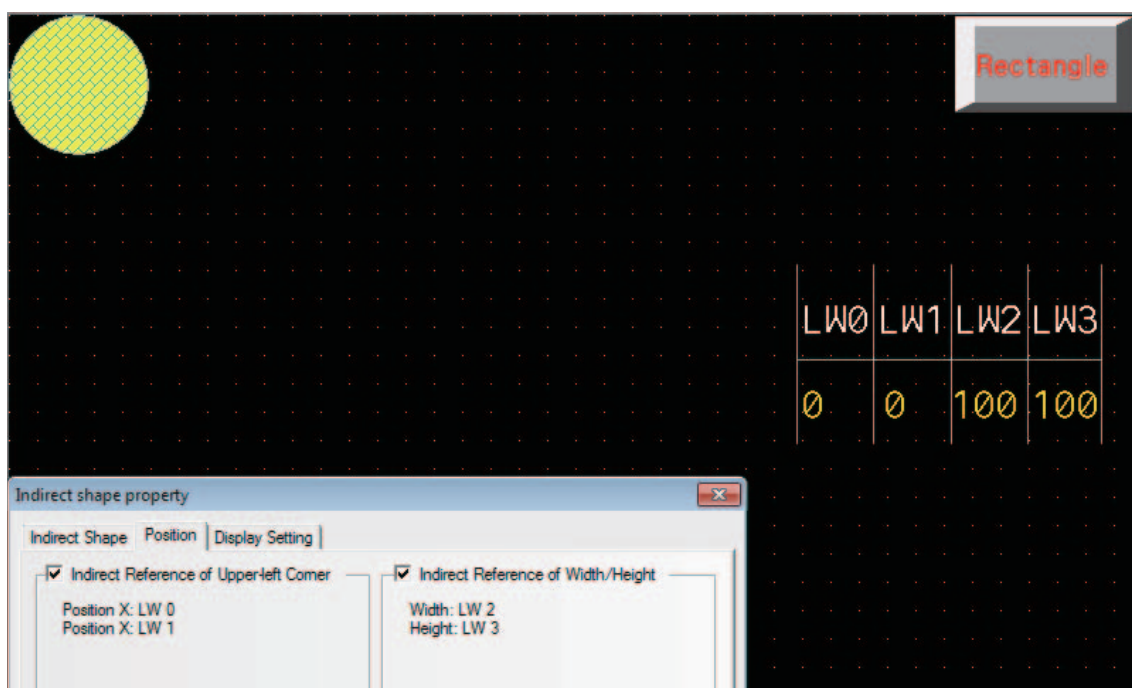

**2** Set and place Indirect Shape (Rectangle) components as follows:

- [Shape] : Rectangle
- top address of [Indirect Reference of Upper-left Corner] : LW0
- top address of [Indirect Reference of Width/Height] : LW2

Storing the values as follows, the effect is shown as below:

- LW0 (Coordinate position of X in upper-left corner) : 50
- LW1 (Coordinate position of Y in upper-left corner) : 80
- LW2 (Width) : 200
- LW3 (Height) : 100

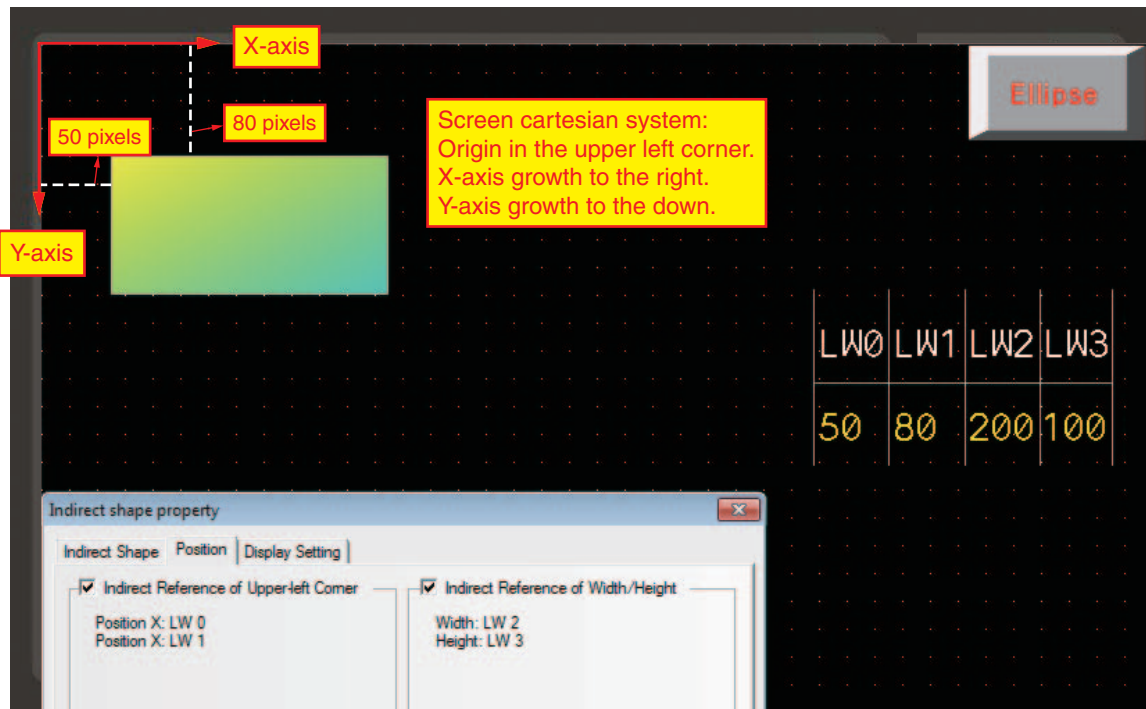

### 3-7-12 User Information

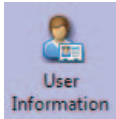

When the system uses User Permission function, the related information of the current login user can be displayed in the table form by using the User Information component. The User Information component must be used in combination with the User Permission, otherwise it will not work. Refer to 3-10-6 *User Permission Setting (Page 3-310)* in *NB-Designer Operation* for the details.

### 3-7-13 Multifunction

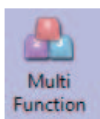

The component which is unified the Bit Button and the Word Switch can operate the both the bit set and the word set through one key.

The Multifunction component can be created by using the mouse to click [Components] - [Button/Switch] - [Multifunction] or dragging [Multifunction] component from [Project Library Window] - [Function Parts] to the Edit Window. The number of Actions which can be set by the Multifunction is 16 at max.

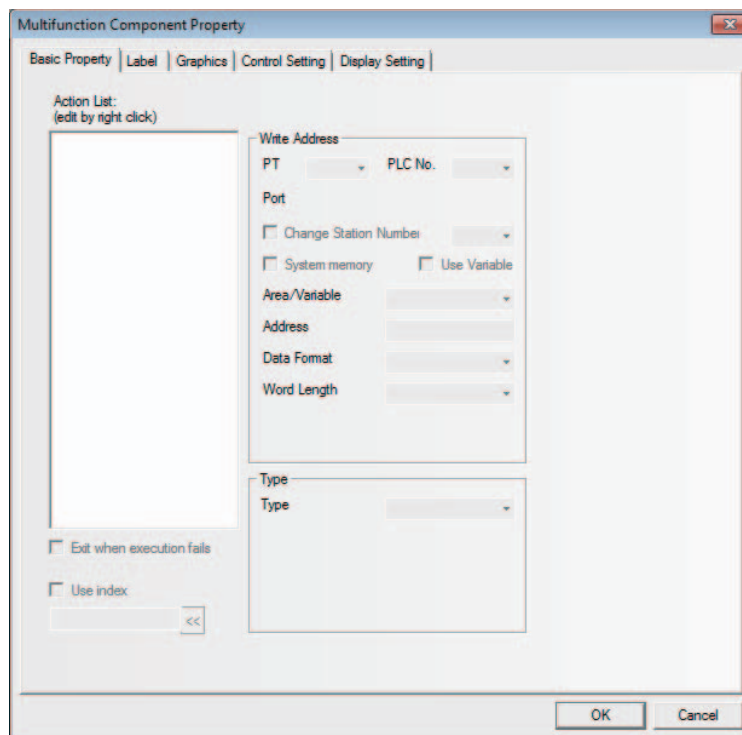

#### ● Process of adding Multifunction component

Right-click the mouse in the blank box located in the left side of Basic Properties tab in the Multifunction Property screen to add the Bit Set or Word Set in the procedure as follows.

- 1** Add the actions (Bit Set and Word Set). Right-click the Action List to select [Insertion Before] or [Insertion After] option to change the execution order of the component.

**2** According to the order to be executed, change the position of the action which was added. Right-click the Action List to select [Move Up] or [Move Down] option to change the execution order of the component.

**3** In order to delete the action which was added, right-click the Action List to select [Delete] option to delete this component.

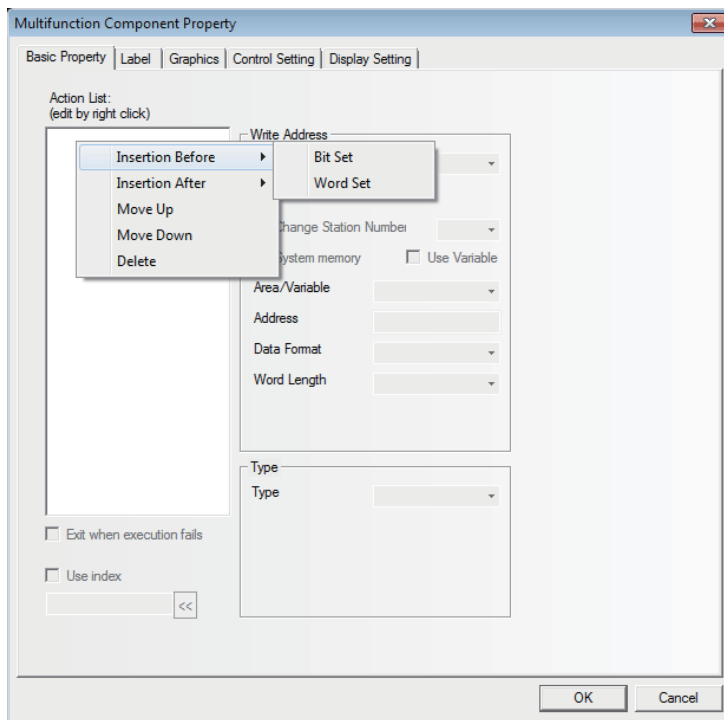

**4** Edit the Property of the Action.

The Property of the Action which was added (Bit Set and Word Set) can be set for each Action at the right area in the [Basic Properties] tab.

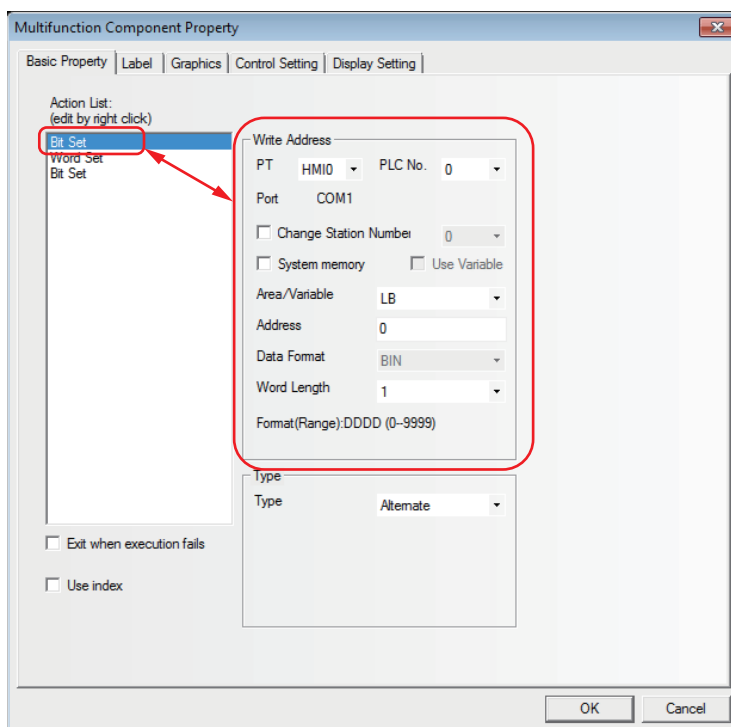

The Bit Set support the Types of [Set], [Reset], and [Alternate] only.

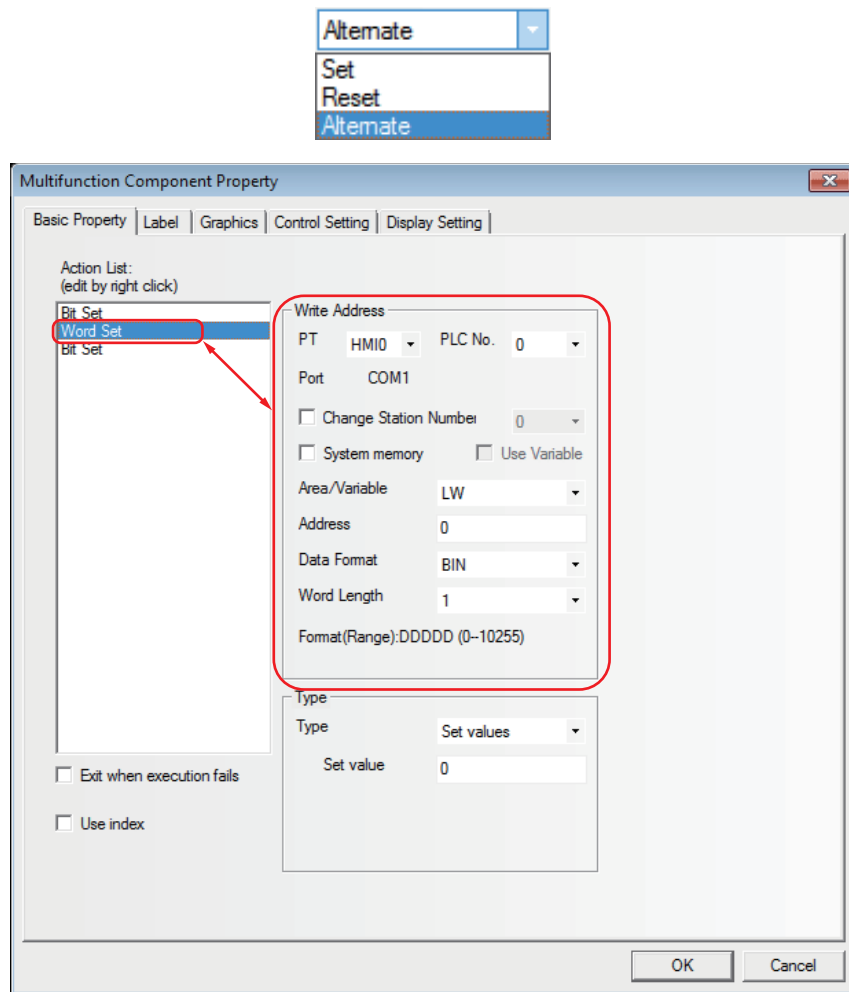

The Word Set support the Types of [Value Setting], [Add Value], and [Subtraction Value] only.

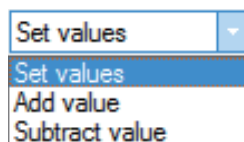

- 5** If the function specified according to the Action List order (ascending order) is failed to execute normally, set the executing operations of the Multifunction by the [Exit when execution fails] checking box.
- Checking the check box  
When executing the function in the order of the Action List, if the specified function cannot be executed, the execution of the Multifunction is quit at the moment and the Action on the List is not executed.
  - Unchecking the check box  
Even if the specified function cannot be executed, when executing the function in the order of the Action List, the next Action on the List will be executed.

### 3-7-14 Event Display



Event Display is used to make the event information logged in [Event Setting] database and meeting the current triggering conditions displayed scrolling from the right to the left.

#### ● Event Display Property

##### 1 Event Setting tab

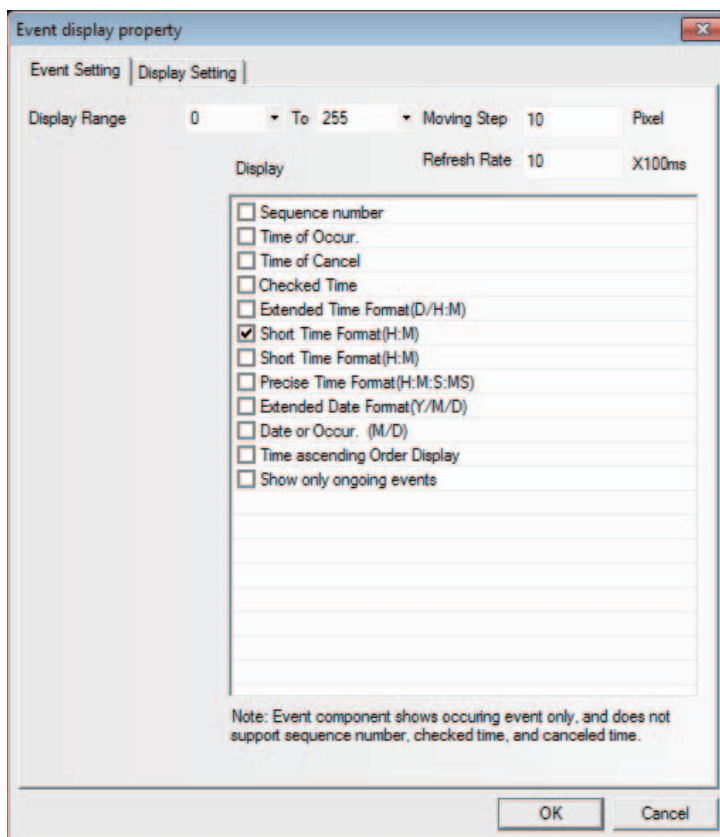

**Display Range:** Specify the range of displaying types (formats) of the event.

**Moving Step:** The pixel point of the width to display the event information in loopy way in units of pixel.

**Refresh Rate:** The period to refresh the display of the event information in loopy way in units of 100ms.

**Display:** The contents are as follows.

For the displayed format of event information, all the selected format information will be displayed before the event information.

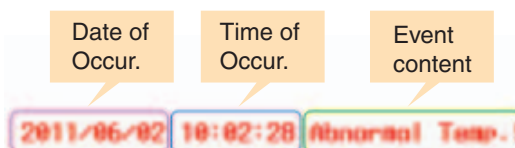

Time of Occur.	The time when the event is triggered.
Extended Time Format (D/H: M)	The time format is displayed as Day/Hour: Minute.
Short Time Format (H: M)	The time format is displayed as Hour: Minute.



Standard Time Format (H: M: S)	The time format is displayed as Hour: Minute: Second.
Precise Time Format (H: M: S: MS)	The time format is displayed as Hour: Minute: Second: Millisecond.
Extended Date Format (Y/M/D)	The date is displayed as Year/Month/Day.
Date of Occur. (M/D)	The date is displayed as Month/Day.
Time ascending Order Display	<p>Checking this option means the event time ascends from the front to back with the latest event information at the end, as shown below:</p> <p style="text-align: center;"><b>2010/12/07 16:46:12 Event2    2010/12/07 16:46:13 Event1</b></p> <p>Not-checking this option means the event time descends from the front to back with the latest event information at the front, as shown below:</p> <p style="text-align: center;"><b>2010/12/07 16:50:19 Event1    2010/12/07 16:50:18 Event2</b></p>

**Note 1** The Event Display only displays the occurring event, and dose not support “Sequence No.”, “Time of Cancel” and “Check Time”.

**2** Once the triggered event information is unmatched, the unmatched event will not be displayed in the Event Display anymore.

The effect of offline test is as shown below.

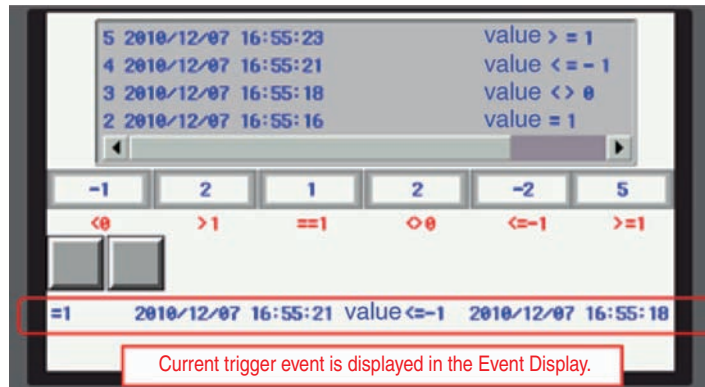

## 3-8 Project Database

### 3-8-1 Text Library

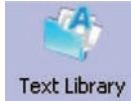

**Text Library** Text Library can be used to store the text contents needed by the project, thus preventing the label with the same text from being input frequently. In addition, Text Library can be used to the conditions with the requirement of multi-language support to realize the switching among the multiple languages for the PT Edit screen. NB-Designer currently supports up to 32 kinds of languages setting.

#### 1 Text Input

- (1) Pressing  icon or clicking [Text Library] in the [Project Database] of the [Project Library] allows the Text Library to pop up.

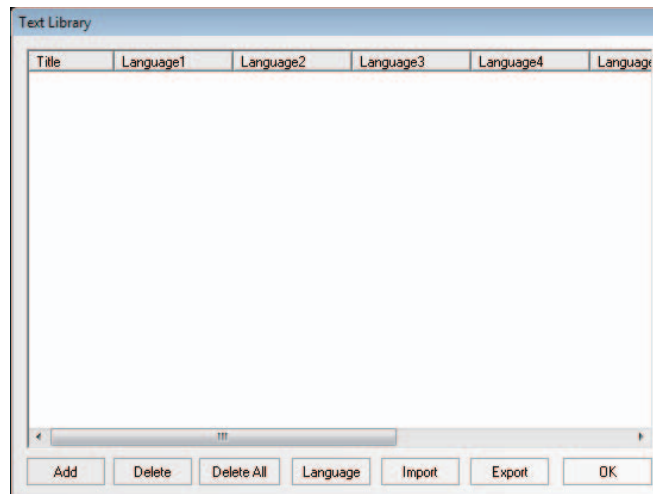

- (2) When the following “Add Text” dialog box appears after “Add” being clicked, fill in the Title, State No. and click “OK” to proceed to the next step.

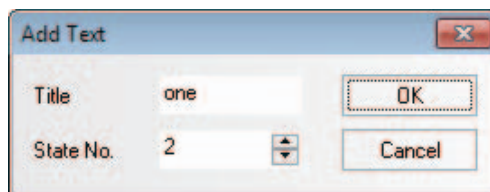

**Note** Once the text title is registered, it cannot be modified in the [Text Library] dialog box.

- (3) The text added just now has been in the Text Library already, and click the “+” placed before the “Title” to see the text string.

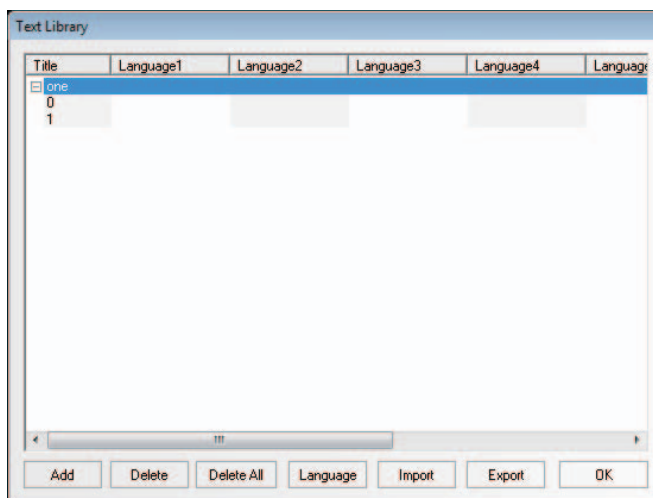

- (4) Input the text in each language for each state, as shown below.

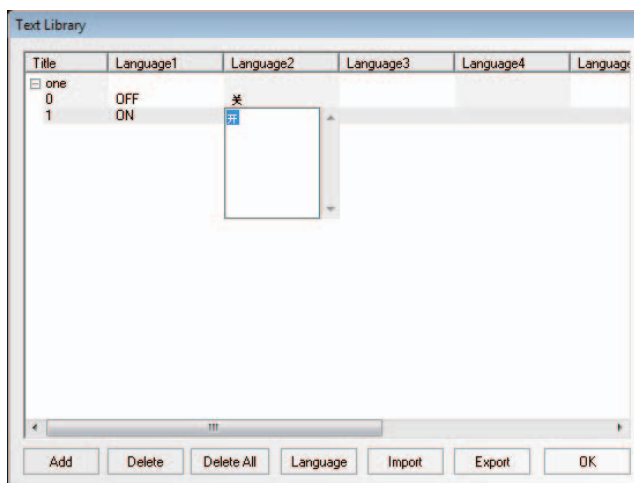

- (5) If you use 2 states, it just needs to input the corresponding text to state 0 and state 1 respectively for each language, and then click “OK” after the completion of the text addition.

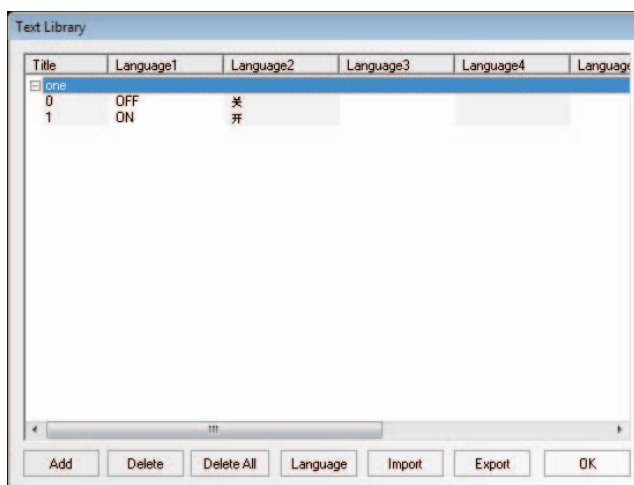

- (6) Checking the [Use Text Library] check box in the [Label] tab of dialog box for each Property allows using the text string which was registered to the [Text Library].

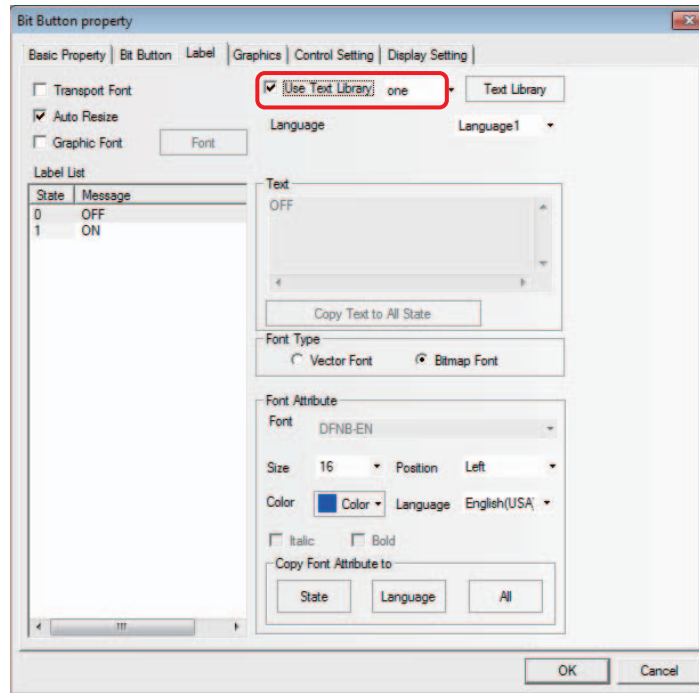

If you haven't added the text to the Text Library, "Use Text Library" can't be checked and is always grayed out until you have added the text into the Text Library.

## 2 Multi-language Switching

The switching among the multiple languages can be realized by modifying the value of special register system memory (LW9130). As long as the value of LW9130 is changed in any one of screens, the displayed text will switch to the text (language) corresponding to the value being changed to, and the language of the whole system will be changed regardless of the condition of the current screen. Only resetting the value of LW9130 can make the language switched again.

It is based on the system special memory LW9130 to realize the multi-language switching in the Text Library.

That's to say:

When LW9130 is 0, the contents corresponding to Language 1 in Text Library will be displayed;

When LW9130 is 1, the contents corresponding to Language 2 in Text Library will be displayed;

When LW9130 is 2, the contents corresponding to Language 3 in Text Library will be displayed;

and so on.

When LW9130 is 31, the contents corresponding to Language 32 in Text Library will be displayed;

When LW9130 is greater than 31, the contents corresponding to Language 1 in Text Library will be displayed.

**Note** "Number of Language" in [PT Property]-[PT Extended Properties] can restrict the number of Language(s) displayed in Text Library. When the Text Library is used for the first time, the default "Number of Language" is 8. Even if LW9130 is greater than 8, the system can only display the contents corresponding to Language 1 to Language 8. If the languages to be displayed are greater than 8 [Max No. of Languages] needs to be increased in [Language Setting] screen with [Number of Language] not exceeding [Max No. of Languages].

“Default Language” in [PT Property]-[PT Extended Properties] refers to the language number to be displayed in the default Text Library. For example: When Language 2 in the Text Library is English, if “Default Language” is set to “2”, the text using the Text Library will be displayed as “English” on the System Screen after PT is powered ON and be switched to another language until the value of LW9130 is changed.

### 3 Language Setting of Text Library

Clicking “Language Setting” in [PT Property]-[PT Extended Properties] or clicking “Language” from the Text Library can open [Language Setting] dialog box to set the global Property of the text font corresponding to each kind of language.

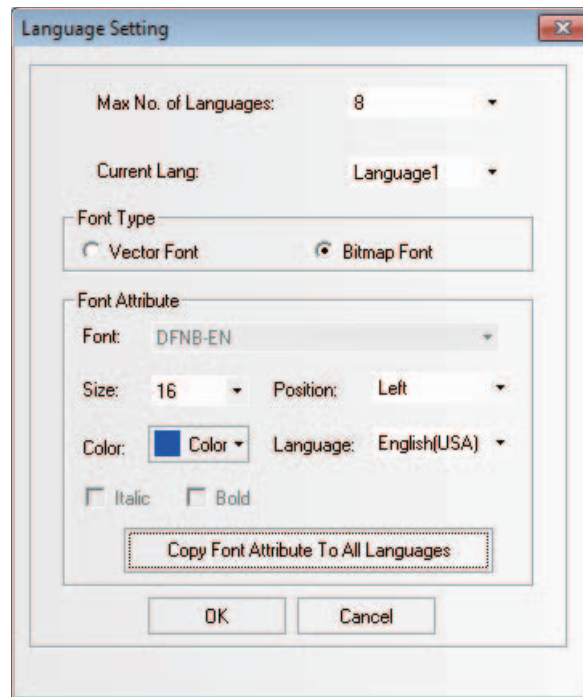

**Max No. of Languages:** The Text Library supports up to 32 kinds of languages with the Default Language of 8. If the user needs more than 8 kinds of languages, the Max No. of Language should be increased.

**Current Lang:** Refers to the language being edited currently.

**Font type:** Sets the font type of the language used currently to Vector Font or Bitmap Font .

**Font Attribute:** Sets the related attributes of the language used currently such as the Font, Size, Position, Color and Italic and Bold.

**Copy Font Attribute To All Language:** Copying the font attribute which is edited currently to all the other languages.

**Language:** The description of the language which is edited currently. The entry procedure to the OS of the current PC is displayed.

- Note 1** Although the font attribute for each language specified to [Language Setting] is specified to all the component as default, the font attribute specified individually for each component attribute in the [Label] tab has a high priority.
- 2** Changing the Font Attribute setting in [Language Setting] will not affect the component specified already the Text Library as the font attributes of label. To use the Font Attribute modified in [Language Setting], it needs to recheck “Use Text Library” in [Label] tab after the checking being cancelled, in order to refresh the Font Attribute setting in [Language Setting].

### 4 Import/Export of Text Library

Text Library has the functions of importing & exporting the registered text in CSV format. Exporting the registered text to the Text Library to the one in CSV format allows edition by the spreadsheet software. Also importing the edited file can be taken in the NB-Designer.

● **Export Text Library**

(1) The following dialog box will pop up after “Export” is clicked.

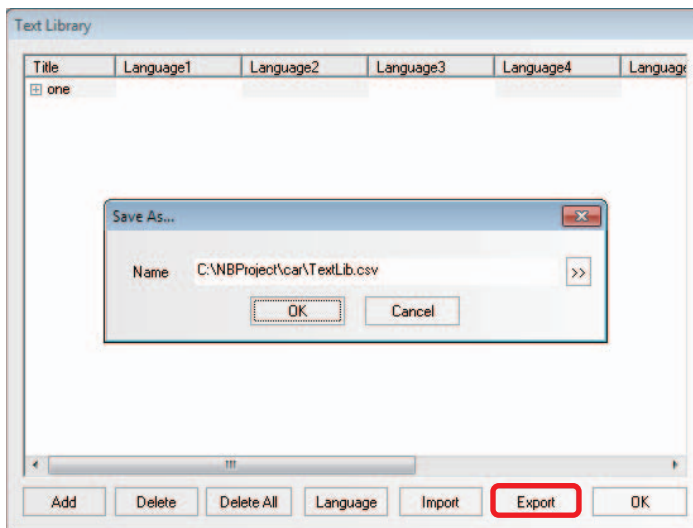

(2) Click [OK] to export the file. In order to change the destination to save the file and the filename, click [>>] and specify the destination to save the file to and the filename.

(3) If the exporting is completed, the message saying “The file is exported successfully!” will be pop up.

The opened export file in .csv format is as shown below.

	A	B	C	D
1	Text Lib	V100		
2	Name:	one		
3	Status:		2	
4	Language	Language1	Language2	Language3
5		0 OFF	关	
6		1 ON	开	

● **Import Text Library**

(1) The following dialog box will pop up after “Import” is clicked.

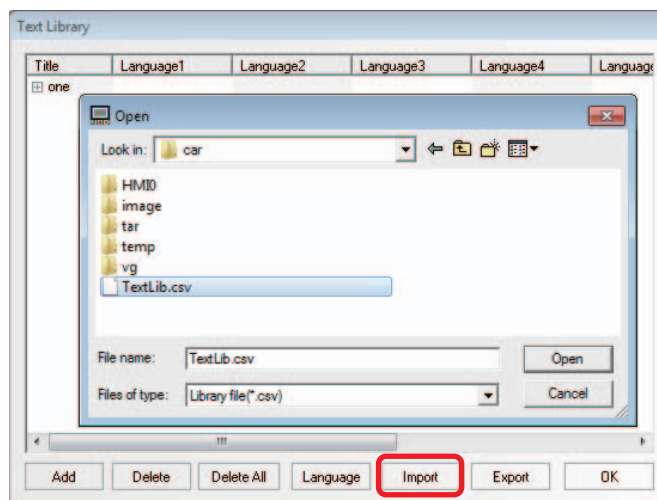

(2) After confirming the CSV file supposed to be imported is not opened by other software, select the CSV file and click [Open].

(3) If “Import file successfully” pops up, it means the import is successful.

- (4) If the imported file in .csv format has the items having the same name with that in the existing Text Library of the system, the selection dialog box will pop up.

In this case, you can select “Yes” or “No” according to the circumstances.

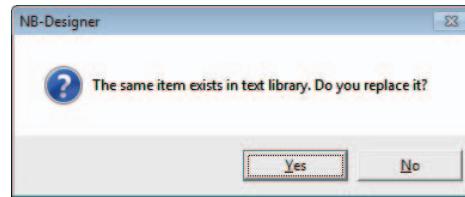

### ● Notes for Import & Export

- (1) The text strings such as “Text Lib”, “Name” and “Status” included in the .csv file can’t be changed, otherwise import will be impossible. Meanwhile, the value of “Status” must be consistent with the actual status lines, as shown below, i.e. when “Status” is 2, the two statuses contained in the text can only be “0” and “1”.

	A	B	C	D
1	Text Lib	V100		
2	Name:	one		
3	Status:	2		
4	Language	Language1	Language2	Language3
5		0 OFF	关	
6		1 ON	开	

- (2) If the line-break exists in the contents of Text Library, the exported file is shown as below.

	A	B	C	D	E	F	G
1	Text Lib	V100					
2	Name:	one					
3	Status:	1					
4	Language	Language1	Language2	Language3	Language4	Language5	Language6
5		0 OFF\$ return	オフ\$ _return_ \$\$_ enter_ \$2分				
6		1 ON	オン				
7							

If line-break is needed in spreadsheet software file, it just needs to input “\$\_return\_ \$\$\_ enter\_ \$”.

- (3) Even after editing the CSV file by spreadsheet software, select “Unicode Text (\*.txt)” for [Type of Document] to save the file and then quit the used application and finally rename the filename extension to .csv. The other file format cannot be recognized as available file to import.
- (4) The “Import” & “Export” are only applicable to the whole Text Library rather than the single text item contained in the Text Library.

## 5 Change of State Number of Text Library

The change method of states number of Text Library is to select one state and right-click the mouse, as shown below.

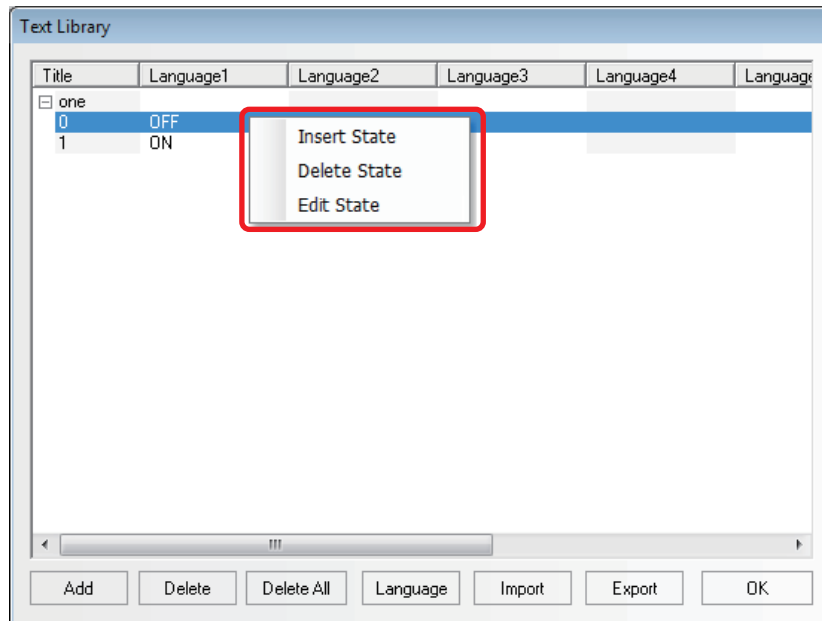

### 3-8-2 Variable Table



Variable Table is a useful address logon library, which prevents the inconvenience resulting from repeated input of address, thus saving a lot of time. Check the [Use Variable] check box in setting items for each component to use the address which was registered to the Variable Table with the settings for each component.

- 1 Clicking  icon or entering [Variable Table] in the [Project Database] allows Variable Table to pop up.

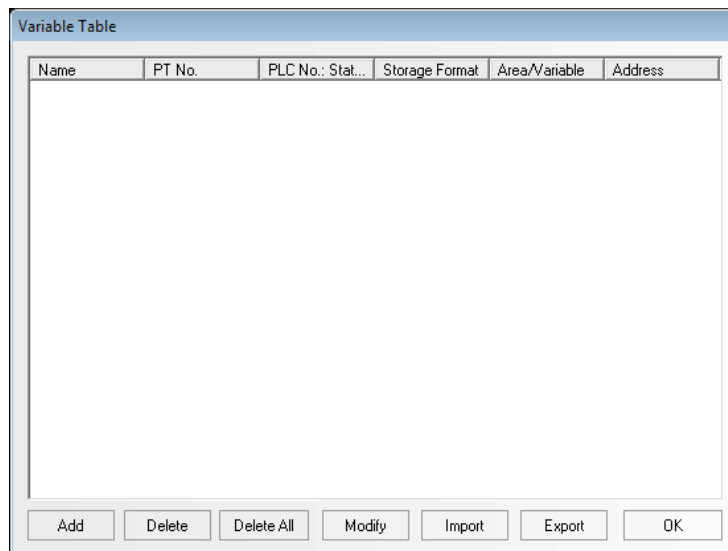



- 2** Click “Add” to make the following small dialog box pop up.

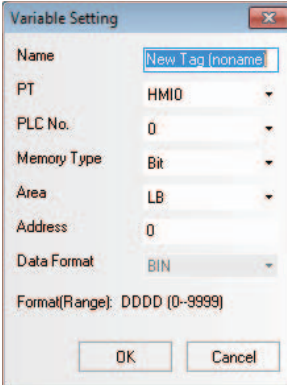

The Variable Setting dialog box contains the following fields and options:

- Name: New Tag (noname)
- PT: HMIO
- PLC No.: 0
- Memory Type: Bit
- Area: LB
- Address: 0
- Data Format: BIN
- Format(Range): DDDD (0-9999)

Buttons: OK, Cancel

**Name:** Inputs the name of this variable.

**PT:** Selects the No. of PT corresponding to this variable.

**PLC No. :** Selects the No. of PLC corresponding to this variable.

**Memory Type:** Selects the memory type corresponding to this address from “Bit” or “Word”.

**Area:** Selects the area corresponding to this variable from “the internal memory of the PT” and “the memory of the PLC”.

**Address:** Specify the address corresponding to the adding address.

**Data Format:** Select the data format of the adding address from “BIN” or “BCD”.

**Format (Range):** Displays the address format (the address range) of this variable.

- 3** Input the above-mentioned items respectively, and click “OK”, then the variable will appear in the library.

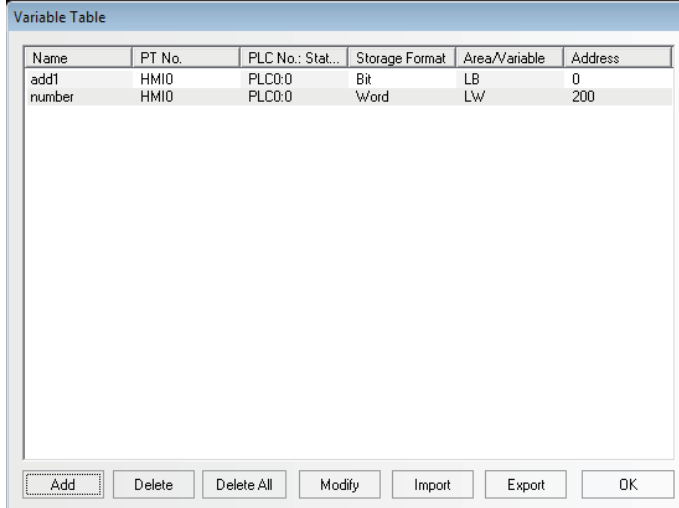

The Variable Table dialog box displays a table with the following data:

Name	PT No.	PLC No.: Stat...	Storage Format	Area/Variable	Address
add1	HMIO	PLC0:0	Bit	LB	0
number	HMIO	PLC0:0	Word	LW	200

Buttons: Add, Delete, Delete All, Modify, Import, Export, OK

**4** Later you can use it in the other places, as shown below.

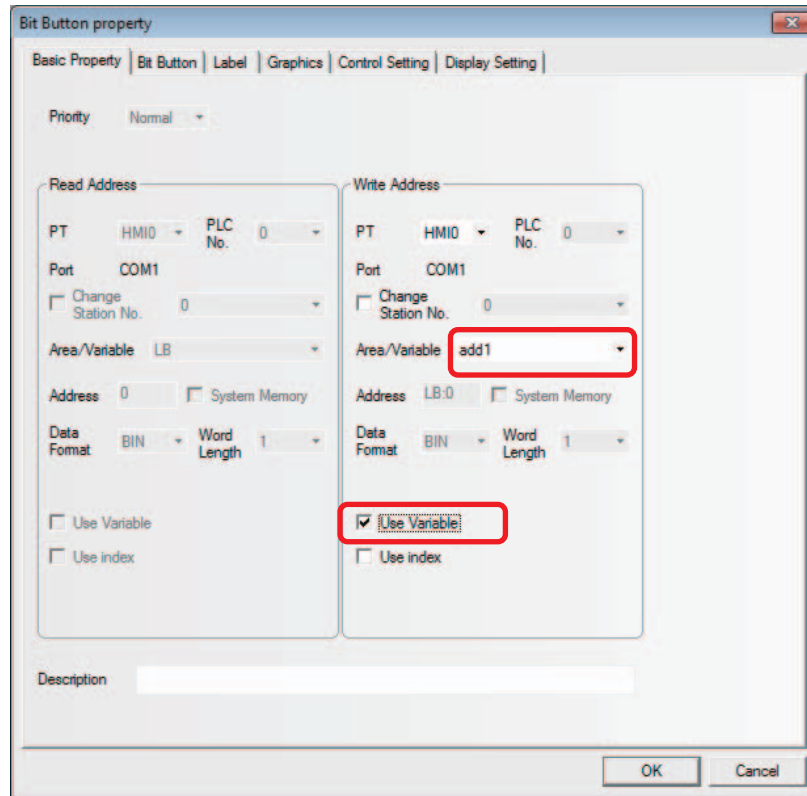

**Note 1** The addresses having been logged in the Variable Table can't be changed in the other places, that's to say, they can only be used. If they are needed to be changed, you just need to enter the Variable Table dialog box to change the address.

**2** Note the following points when using the Variable.  
 The Variable specified [Bit] for the [Memory Type] can be allocated only to the bit state component. Also the Variable specified [Word] for the [Memory Type] can be allocated only to the word state component.

**5** Importing/Exporting a Variable Table

You can save variable information as a CSV file by pressing the [Export] button.

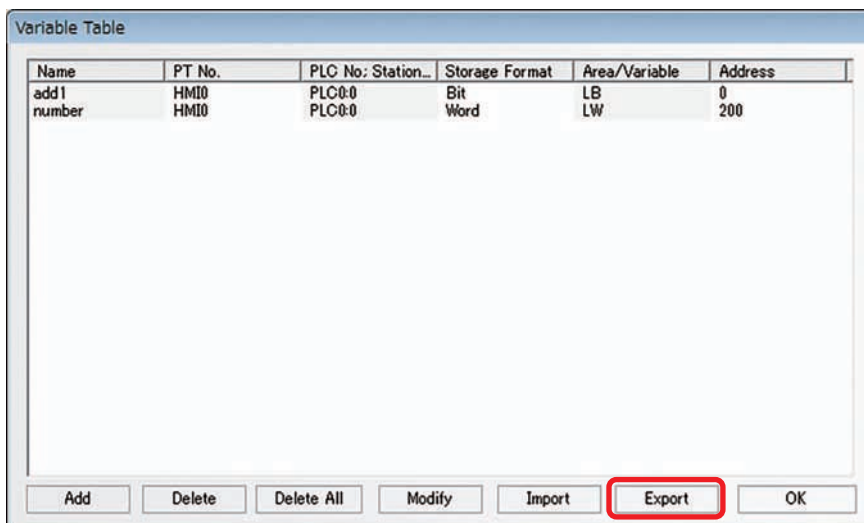

Press [Import] to import the variable information from a CSV file.

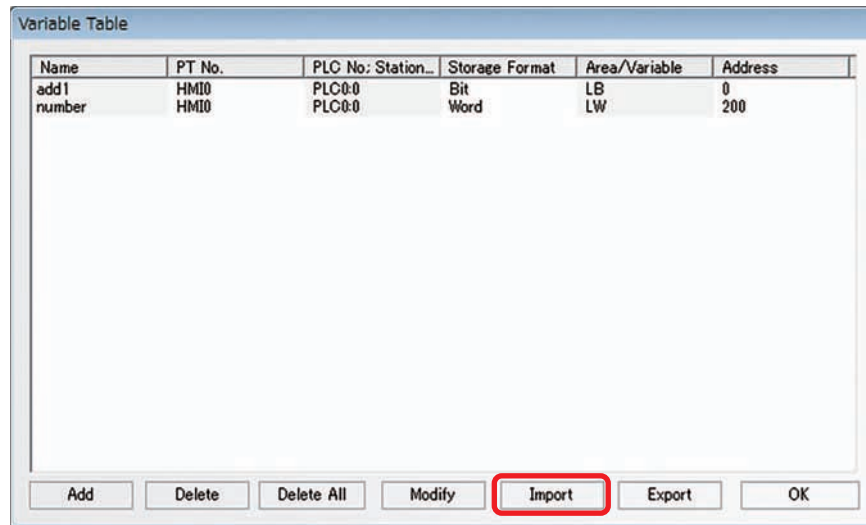

## 6 Importing Variables of NJ and NX Series

Variables of NJ and NX series can be imported to a variable table.

- (1) Click [Tools] - [Export Global Variables] - [CX-Designer] under the Sysmac Studio Menu to export the information about variables of NJ and NX series to Clipboard.
- (2) Right-click on the Variable Table window. Select [Import Variable] to load the variable information exported to the Clipboard \*1.

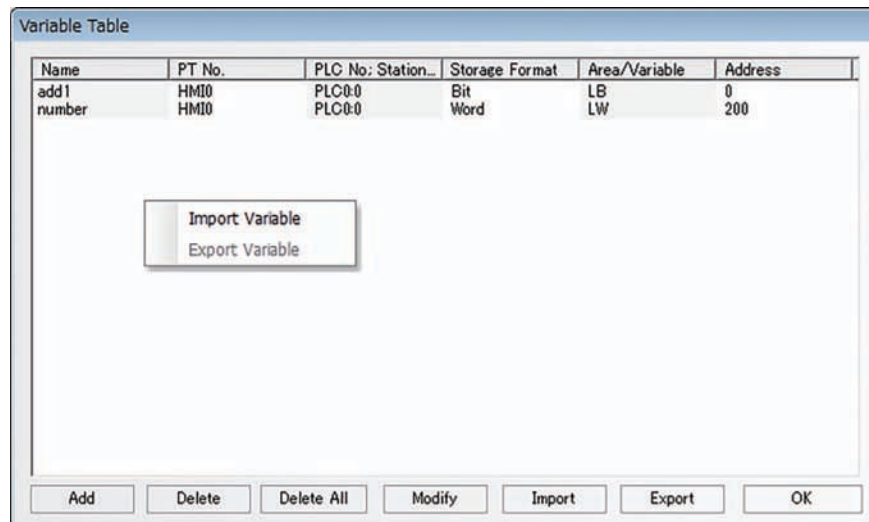

\*1 Importing variables is allowed only when you are using Omron Host that executes Ethernet communication.

- (3) A window to select a host appears after importing variables. Select the host, an import destination.

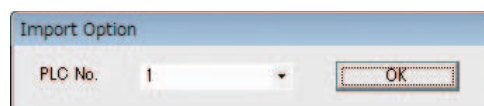

(4) Click [OK] to import the variables of NJ and NX series.

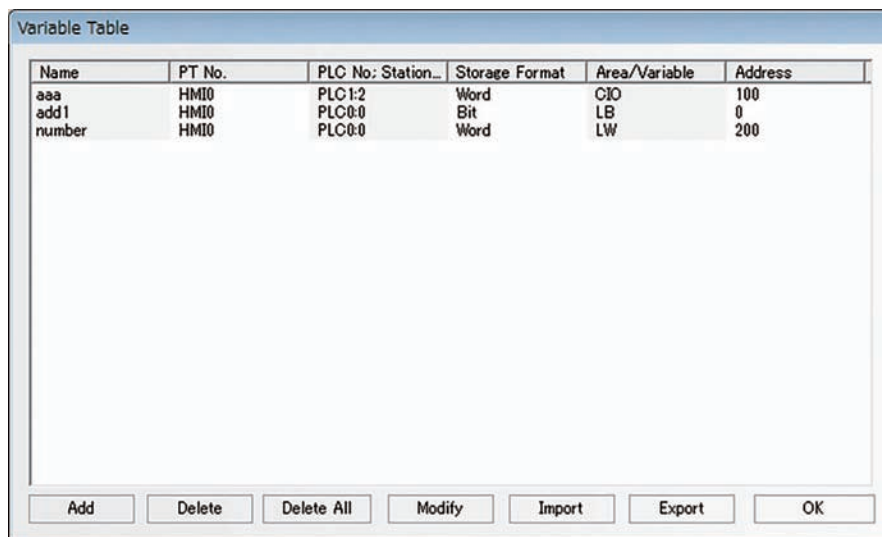

**Note** You can import only variables to which AT Specification address is allocated in Sysmac Studio. Variable types to be imported are: BOOL, UINT/ INT/ WORD, UDINT/ DINT/ DWORD/ REAL. On NB-Designer, BOOL variable is replaced to Bit, UINT/ INT/ WORD are replaced to Word, and UDINT/ DINT/ DWORD/ REAL are replaced to DWORD. DWORD variable cannot be edited on NB-Designer.

### 3-8-3 Alarm Setting



To display the information on the Alarm component or Alarm Display component, the logon in the list of [Alarm Setting] database is needed. One bit address can control whether one piece of information will be displayed or not. If the logged bit address is triggered (ON or OFF), the related information will be displayed on the Alarm component. (This component is only responsible for the logon of Alarm Setting, and the display needs to be done by “Alarm” component.)

#### ● Add/Modify Alarm Setting

- 1 Clicking the  icon located in the Database Toolbar or the “Alarm Setting” in the “Project Database” allows an “Alarm Setting” dialog box to pop up.

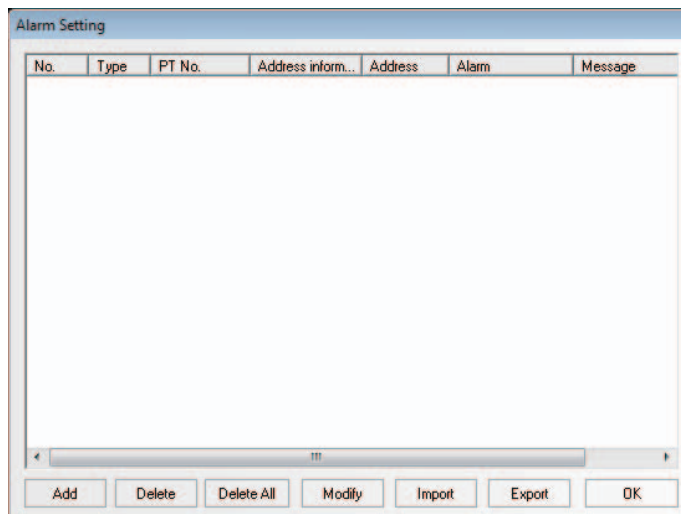

- 2** Select the [Add] button to add the setting or select the [Modify] button to modify the existing setting.

Descriptions of Alarm Information Property		
Triggered PT	Select one PT to specify the Alarm Setting when multiple PTs were registered to the project.	
PLC Address	Specifies the bit address of the memory that triggers the read of the alarm.	
Property	ON	When the specified bit address is ON, one piece of alarm information is generated.
	OFF	When the specified bit address is OFF, one piece of alarm information is generated.
	Use Buzzer	When the alarm information is triggered, the buzzer will be enabled. The Buzzer Time can be set with the unit of "second".
Message	Inputs the contents of alarm setting to be displayed. Clicking [Font] can set the Font and the related attributes.	
Use Text Library	Determines whether to use the contents logged in the Text Library. For the use of the Library, refer to [3-8-1 Text Library].	
Language	When using multi-language Text Library, you can select the language here and click "Font" to set the font attributes corresponding to text in each kind of language respectively.	

- 3** Press the [OK] button to make the alarm setting displayed in the list. After the alarm setting is logged, the existed alarm setting can be edited by [Delete] or modified by [Modify] buttons. Press the [OK] button to complete the logon of the alarm setting.

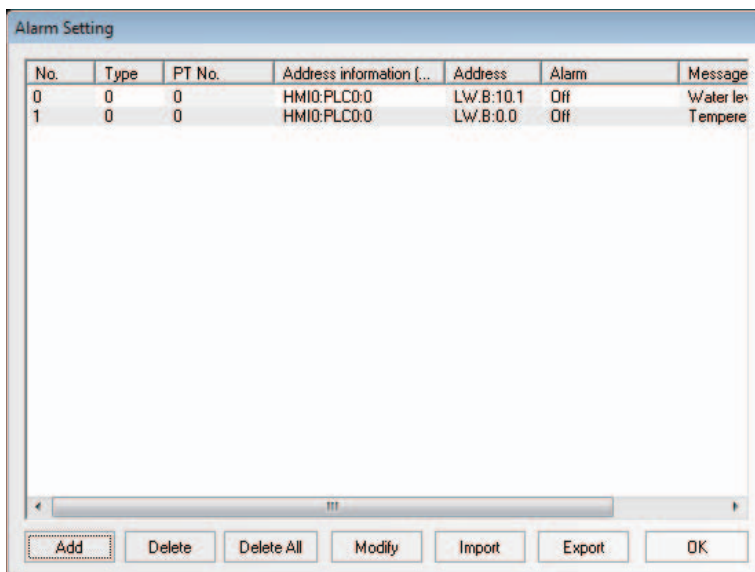

**Note** In order to perform the communications effectively, specifying the continuous address is recommended as read address of the alarm information. For example, when you specify the continuous addresses from M100 to M199, whole the addresses from M100 to M199 can be read in the communications only once.

### ● Event/Alarm Type

The Event/Alarm is divided into 256 types, i.e. 0 to 255, in the NB-Designer.

Event, Alarm and Alarm Display can restrict the types of the displayed events respectively. For example, if the display type of "Event Component" is specified from 0 to 3 in the [Event Setting] tab of Event Properties, only the contents of event ranging from Type 0 to Type 3 will be displayed.

This option is used to select the type of the alarm and event displayed currently.

**Example:** To create an event log with the type of each event being different.

- (1) Click the [Event Setting] of the [Project Database] and open the [Event Setting] dialog box. Click the [Add] and add a new event setting as below.

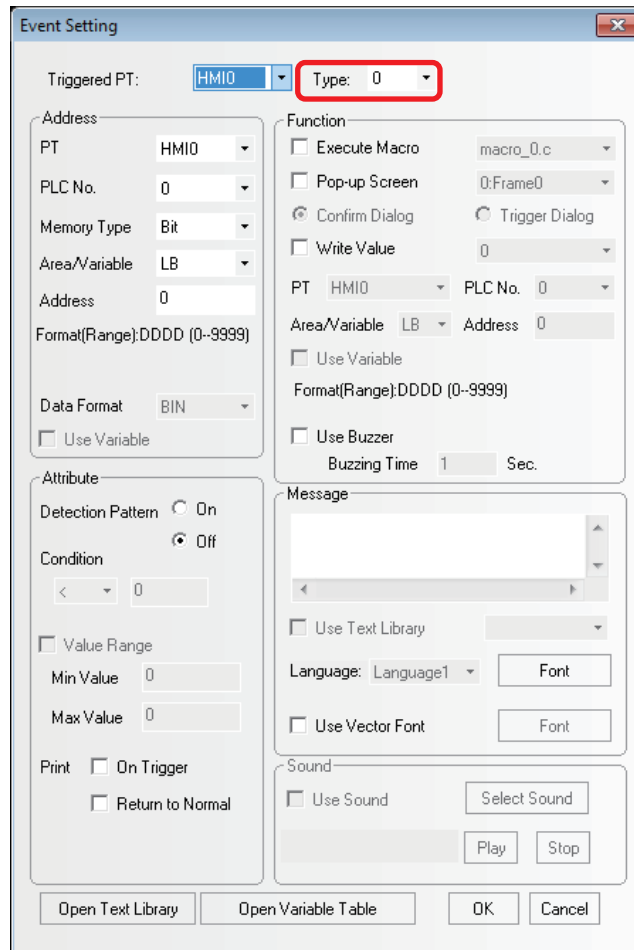

- (2) Create the event triggered by the LB1 and LB2 in the same procedure as the LB0's. The Type of the LB1 is specified to 1 and the Type of the LB2 is specified to 2.

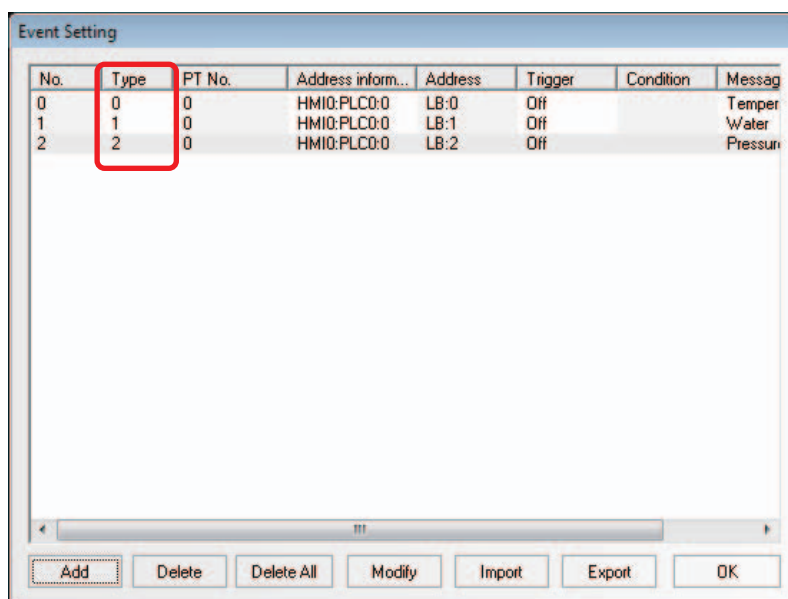

(3) Place two Event components with the addresses of LW0 in the Edit Window and the settings are as shown below.

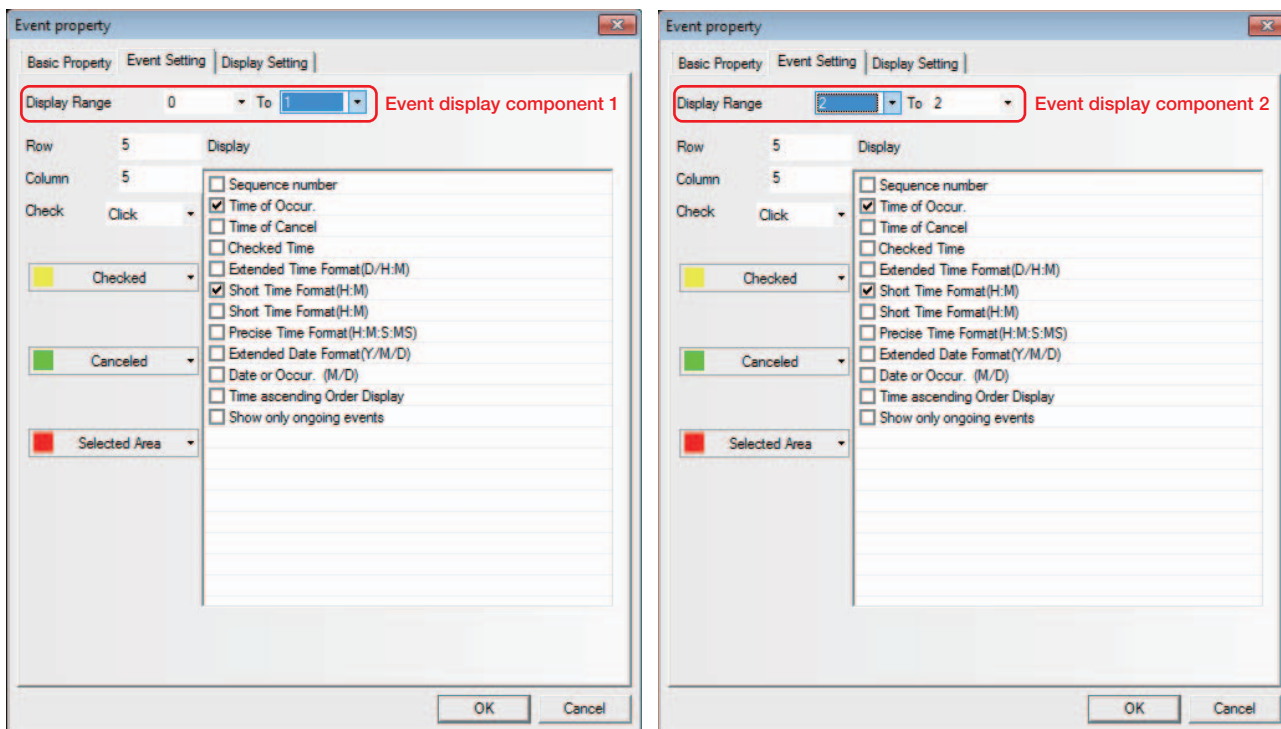

(4) When the offline test is performed, the event with the format (type) 0 of ON and the trigger for the LB0 and the format (type) 1 of ON and the trigger for the LB1 is displayed in Event component 1 and the other event with the format (type) of ON and the trigger for the LB2 is displayed in Event component 2.

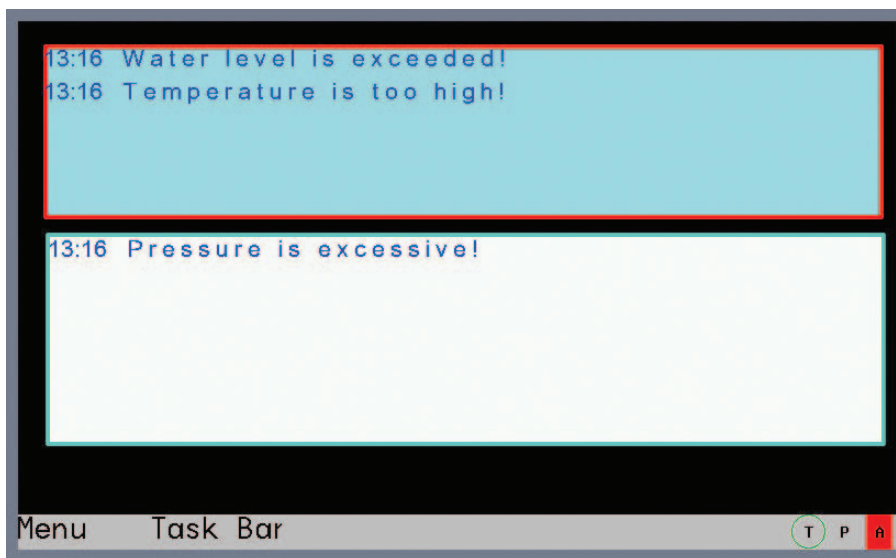



### 3-8-4 Event Setting



The information logged in Event component will be displayed in the Event component. To display the information in the Event component, the information must be logged in the [Event Setting] database in advance. One bit or word address controls one piece of information. When the logged bit or word address is triggered (i.e. It is ON/OFF or the restricted value is triggered.), the corresponding information will be displayed in the Event component. (This component is only responsible for the event log, and the display needs to be done by "Event" component.)

#### ● Process of Adding/Modifying Event Setting

- 1 Clicking the  icon located in Database Toolbar or "Event Setting" in the "Project Database" allow "Event Setting" dialog box pops up.

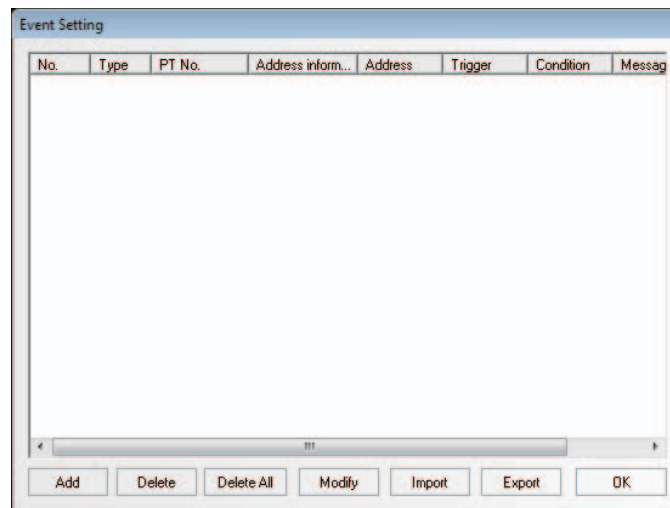

- 2** Select the [Add] button to add the information or select the [Modify] button to modify the existing information.

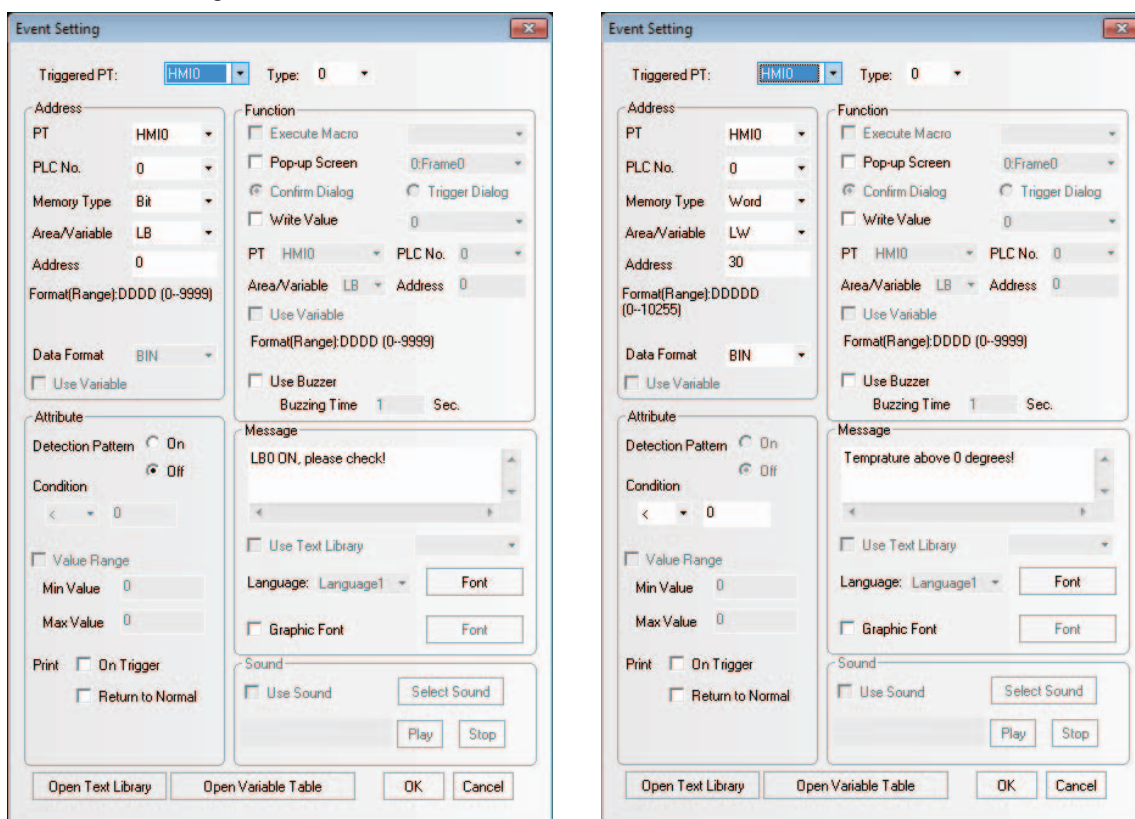

Descriptions of Event Information Properties			
Triggered PT	Select one PT to specify the Event Setting when multiple PTs were registered to the project.		
Type	Classifies the events and the available type is from 0 to 255. [Event Display] tab of the Event Display component can restrict the displayed event type.		
Address	Specify the register working as the trigger of the event. The type of memory can be changed into "Bit" or "Word" through "Data Type".		
Attribute	Bit	ON	When the state of the bit address is turn from OFF to ON, one specified event record will be displayed.
		OFF	When the state of the bit address is turn from ON to OFF, one specified event record will be displayed.

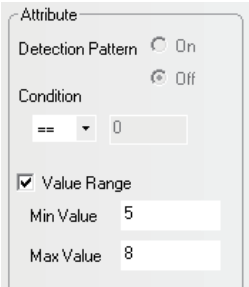
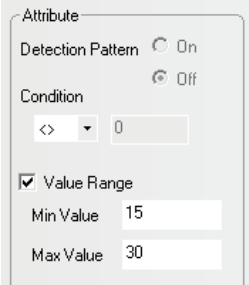
Descriptions of Event Information Properties			
Attribute	Word	<	When the value of the specified word address is less than the specified value, one specified event record will be displayed.
		>	When the value of the specified word address is greater than the specified value, one specified event record will be displayed.
		==	When the value of the specified word address is equal to the specified value, one specified event record will be displayed.
		[Value Range]	When the value of the specified word address is within the specified range, one event record will be generated. As shown below, check "Value Range" with "Min Value" & "Max Value" set to "5" and "10" respectively, if the value which is represented as N, of the specified word address is larger than 5 and smaller than 10, one specified event record will be displayed.
			
		< >	When the value of the specified word address is not equal to the specified value, one specified event record will be displayed. As shown below, check "Value Range" with "Min Value" & "Max Value" set to "15" and "30" respectively, if the value which is less than 15 or larger than 30, one specified event record will be displayed.
			
< =	When the value of the specified word address is less than or equal to the specified value, one specified event record will be displayed.		
> =	When the value of the specified word address is greater than or equal to the specified value, one specified event record will be displayed.		
Function	Execute Macro		When event occurs, the selected Macro will be executed. *
	Pop-up Screen	Confirm Dialog	Touching the event information displayed in the event component, the specified screen will pop up. And it needs to use the "Close Screen" function of the Function Key to close this Pop-up Screen.
		Trigger Dialog	The specified screen will pop up when the event occurs. And it needs to use the "Close Screen" function of the Function Key to close this Pop-up Screen.
	Write Value	0	When the event log occurs, the state of the specified bit memory will be set to "0".
		1	When the event log occurs, the state of the specified bit memory will be set to "1".
Not		When the event log occurs, the state of the specified bit memory will be reversed.	

Descriptions of Event Information Properties	
Message	Inputs the contents of event or event display to be displayed. Clicking [Font] can set the Font Type and the related attributes.
Use Text Library	Determines whether to use the contents logged in the Text Library.
Language	When using multi-language Text Library, you can select the language displayed as the event information here and click "Font" to set the font Property corresponding to text in each kind of language respectively.
	<p>TIP: The data and others stored in internal memory LW can be displayed in the event information.</p> <p>The available formats are follows:</p> <ul style="list-style-type: none"> <li>• %h:mm:s#: The Time of Occur. is indicated.</li> <li>• %y:mm:d#: The Date of Occur. is indicated.</li> <li>• %nnfmd:                             <ul style="list-style-type: none"> <li>"%" represents the start symbol, "nn" represents the addresses of the internal memory LW from 00 to 99.</li> <li>"f" represents that the displayed number includes the decimal part.</li> <li>"m" represents the digit of the decimal digit.</li> <li>"d" represents the end symbol.</li> </ul> </li> </ul> <p>If "%nnd" is entered, the value excluded the digit of decimal digit will be displayed. For example, if you want to display the value stored in LW20 with one decimal digit, enter "%20f1d". If the stored value in the PLC memory should be displayed, transferred it to internal memory LW to display it.</p>
Use Buzzer	When the event is triggered, the buzzer will be enabled. The Buzzing Time can be set with the unit of "second".
Open Text Library	Opens the text library editing dialog box.
Open Variable Table	Open the variable editing dialog box.

\* Please refer to 3-9-3 Macro Triggering (Page 3-273) in NB-Designer Operation.

- 3** Clicking [OK] allows the specified event setting added in the List of the [Event Setting] dialog box. The registered event setting can be deleted by [Delete] button or modified by [Modify] button. Click [OK] button to finish the registration of the event setting.

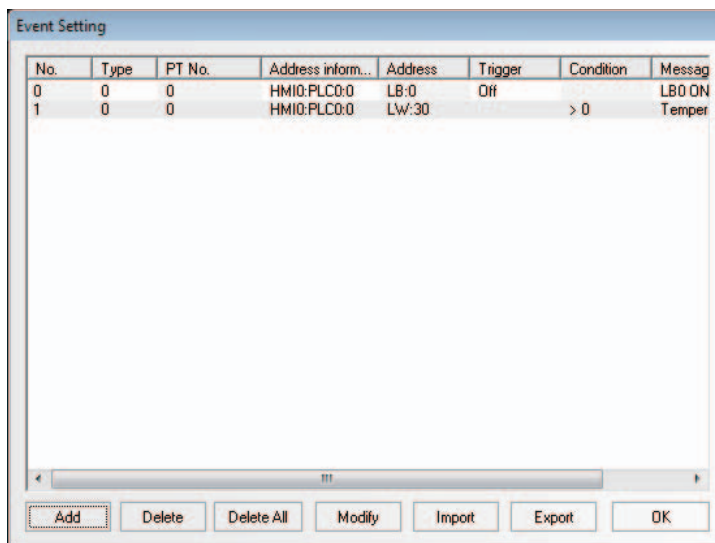

**Note** In order to perform the communications effectively, specifying the continuous address is recommended as read address of the Event Setting. For example, when you specify the continuous addresses from M100 to M199, whole the addresses from M100 to M199 can be read in the communications only once.

### 3-8-5 PLC Control



**PLC Control** When the corresponding control is triggered, PLC Control component can activate one specific operation.

PLC Control component is a powerful component group, which can realize a large variety of functions because it is more powerful than the general component. And its functions are as follows:

- (1) Switch Screens: Changes the current screen.
- (2) Write data (current base screen number) into PLC: Transfers the current Screen No. to the PLC.
- (3) General-purpose PLC control: Realizes the data transmission between the PLC address and LW/RW.
- (4) Backlight Off: Turns off the backlight.
- (5) Backlight Off (Write Back): Turn OFF the back light. (The control bit will be reset.)
- (6) Execute Macro: Executes the corresponding Macro number when the condition is met.
- (7) Backlight On: Turns on the backlight.
- (8) Backlight On (Write Back): Turn ON the back light. (The control bit will be reset.)
- (9) General PLC Control (Expansion)
- (10) Change Screen (Ignore screen 0)

**Note** Do not specify the same address in the functions of Switch Screens, Change Screen (Ignore screen 0), and Write data (current base screen number) into PLC.

#### ● Process of creating one PLC Control

- 1** Press the PLC Control icon to make the list of PLC Control pop up.

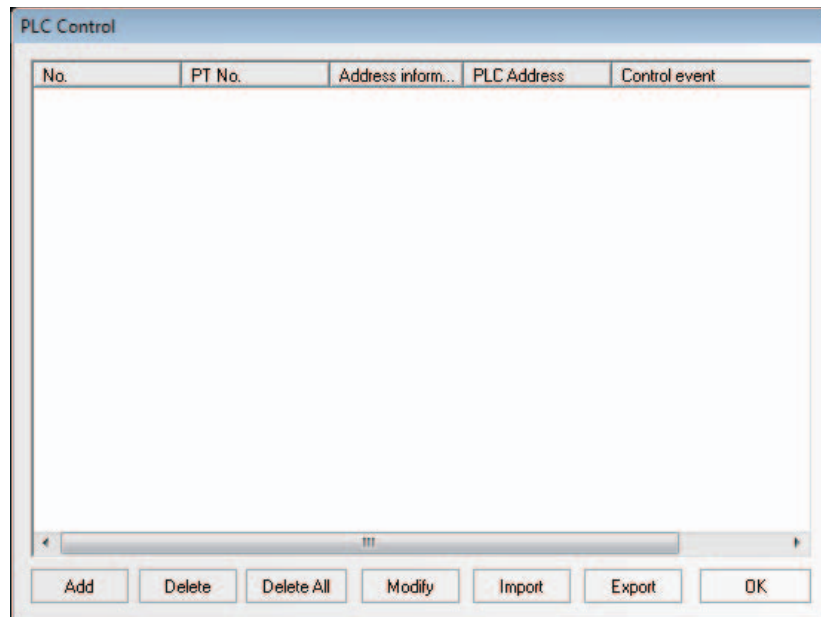

- 2** Press "Add" button to create a new PLC Control or press "Modify" and "Delete" buttons to modify the PLC Control and delete the selected setting respectively.

- 3** Specify the options displayed in the PLC Control dialog box correctly.

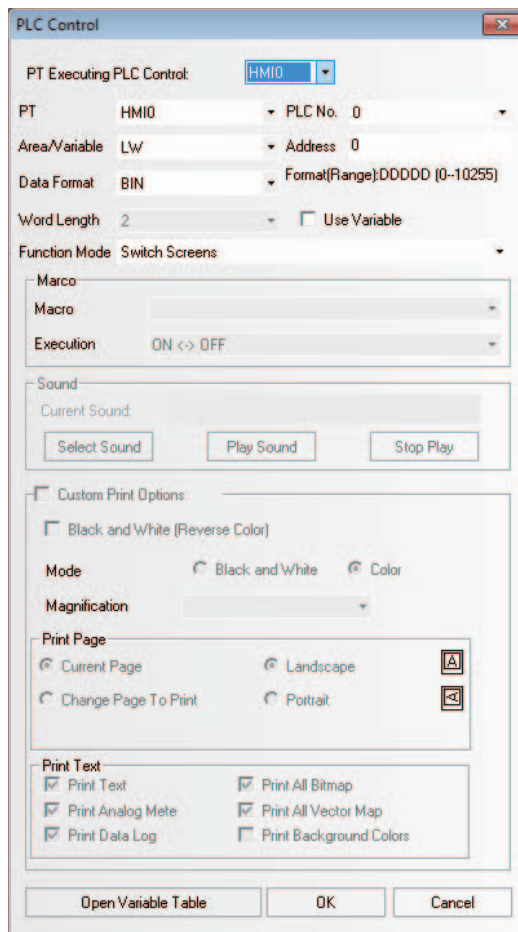

**Area/Variable:** Specifies the Area/Variable of the devices performing the PLC control operations.

**Address:** Specifies the addresses of the devices performing the PLC control operations.

**Data Format:** Includes BIN or BCD.

**Function Mode:** Specifies the operation types of the setting. There are 12 types available, and their functions will be described later in details.

**Macro:** Sets the No. of Macro program to be executed when the Function is “Execute Macro”.

- 4** Press the “OK” button to exit from the PLC Control dialog box.

- 5** Repress the “OK” button to exit from the list of PLC Control.

## ● Function Mode

### 1 Switch Screens

This operation needs 2 consecutive word addresses. When the [Read Address] is switched to a valid screen No., the current screen will be closed and the specified screen will appear. Specify the number in the destination screen in the [Read Address]. The number after switching will be written in [Read Address + 1]

Read Address	For screen switching control
Read Address + 1	No. of the destination screen

For example, set the address to “DM0”, Data Format to “BCD” and the current screen to Frame 0. If DM0 is changed to 10, the current screen will be switched to Frame 10, and 10 will be returned to DM1.

**Note** Each time the [Change Screen] Function Key is pressed, the current screens is closed and the destination screen is displayed. The function of [Switch Screens] of the PLC control is similar to the [Change Screen] function of the Function Key. Their difference is the respect whether function is operated by touching the screen or it is performed by the PLC memory control. When the value of Read Address is modified to an available screen No., the current screen will be closed and the screen specified with the Read Address will be displayed. Then the content of the Read Address in written in the Read Address + 1. This operations can be executed only when the Read Address is modified.

### 2 Write Data (Current Base Screen No.) into PLC

The number of the base screen currently displayed will be notified to the PLC.

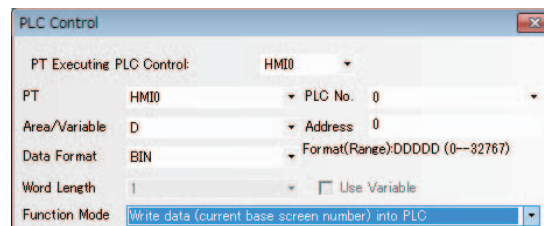

When there is a PLC Control with the settings shown as above, word address DM0 will store the No. of the current base screen.

### 3 General PLC Control

The data transmission between the PLC and the PT can be controlled.

It can be divided into 4 types according to the direction of data transmission:

- PLC→RW (Recipe Data Memory), type code 1.
- PLC→LW (Local Data memory of PT), type code 2.
- RW (Recipe Data memory)→PLC, type code 3.
- LW (Local Data memory of PT)→PLC, type code 4.

The specific instructions are as follows:

Select “General PLC Control” as “Control Type” in PLC Control setting dialog box, and select the data area and the address of the data transmitted by the [Read Address]. Please note that the unit must be “word”, and the system automatically allocate 4 continuous addresses, which are used as the controlling addresses of the data transmission. And the specific meanings and usage methods are as follows:

- Read Address: Select the 4 types of execution type codes. When new value is written to the memory, the system execute the corresponding transmission function. After the transmission is detected, the memory will be reset to 0.
- Read Address + 1: Specify the size of the data transmitted. The number of the word specified at this moment will be transmitted.

- (3) Read Address + 2: Specify the offset of the transmitted data address of the PLC side. The offset is specified from the address of [Specified Read Address + 4].

For example, if the Read Address set in the PLC General Control is DM100, and the data contained in memory DM102 is 4. The starting address of the transmitted PLC data is  $DM108 = [(100 + 4) + 4]$ .

- (4) Read Address + 3 : Specify the offset of the transmitted data address at the sides of local memory (LW) of the PT or Recipe data memory (RW)

In the example listed above, if the data contained in DM103 is 100, the starting address of the transmitted PT data operated during the transmission is  $RW(LW)100=(0 + 100)$ .

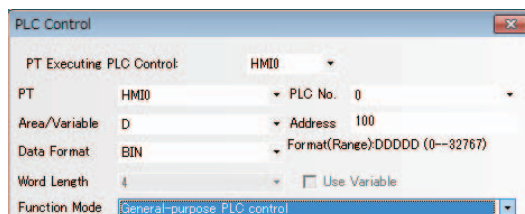

Here is the procedure which uses the PLC control, to transmit the data includes 30 words starting from DM100, to the data block of the same size starting from RW200 in the Recipe Data memory of the PLC.

- (1) Firstly, specify the PLC control component set with [General-purpose PLC Control] for the control select and DM10 for [Read Address].
- (2) Secondly, specify the size of the data and the offset address of the controlling data. DM11 is specified to 30 (it means the number of transmitted words is 30 words.) DM12 is specified to 86 (the starting address is  $DM100=(10+4+86)$  in the PLC and DM13 is specified to 200 (the destination address is  $RW200=(0+200)$ , respectively.
- (3) Finally, specifying the execute type code according to the direction of the data transmission allows the data transmission. If DM10 is specified to 1, the number of the specified data will be transmitted from the starting address of the PLC to the Recipe Data memory of the PT. If DM10 is specified to 3, the direction to transmit the data will be reversed.

The other transmission to two destinations are performed in the same procedure as above.

## 4 Backlight Off

This operation uses one bit address to control the closing of the backlight, and when the bit address is ON, the backlight will be closed.

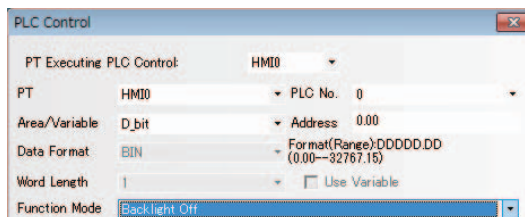

In the settings shown as above, when D\_bit0.00 is ON, the backlight turns off. In this case, when the user touches the PT, the backlight will automatically light on, and at this time the D\_bit0.00 is still ON. If the user touches the D\_bit0.00 again, it will be turned OFF, thus returning to the state before the backlight is closed.



## 5 Backlight Off (Write Back)

The operation of this option is similar to [Backlight Off], but the address of this bit of PLC will be cleared to 0 while as well as the back light turns Off and then the bit address turns ON.

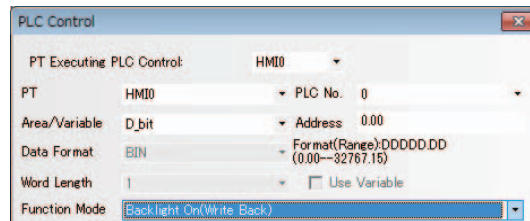

In the settings shown as above, when D\_bit0.00 turns ON, the backlight is OFF, and D\_bit0.00 is automatically turned OFF. When the user touches the PT, the backlight turns ON and D\_bit0.00 remains OFF.

## 6 Execute Macro

When the state of the specified bit address is ON, the selected Macro ID will be triggered.

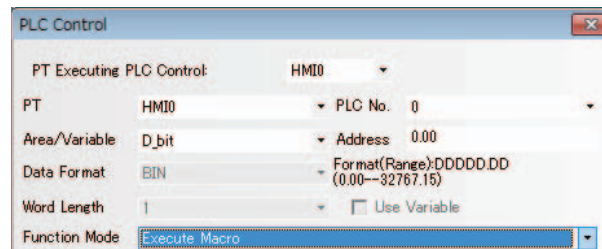

**Area/Variable and Address:** Refers to the address to trigger the Macro program execution. The Macro program will be executed when this bit is 1, while not executed when this bit is 0.

**Macro ID:** Select a Macro to be executed.

**Execute Method:**

ON $\leftarrow$ OFF: When the specified bit turns OFF from ON or vice versa, the Macro will be executed.

OFF $\rightarrow$ ON: When the specified bit turns ON from OFF, the Macro will be executed.

ON $\rightarrow$ OFF: When the specified bit turns OFF from ON, the Macro will be executed.

ON: When the specified bit is ON, the Macro will be executed.

OFF $\rightarrow$ ON, Reset: When the specified bit turns ON from OFF, the Macro will be executed and the specified bit will be forced into OFF.

ON $\rightarrow$ OFF, Reset: When the specified bit turns OFF from ON, the Macro will be executed and the specified bit will be forced into ON.

**Note** Only when the Macro is added within the project, this function is available. If the Macro code is removed after specifying the "Execute Macro" in the Function Mode option the PLC Control dialog box by the Function selection, the code is converted automatically to the Macro in the default. If the Macro does not exist, [Macro] column is left to blank as the default.

## 7 Backlight On

This operation uses one bit address to control the lighting of the backlight, and when the bit address is ON, the backlight turns ON.

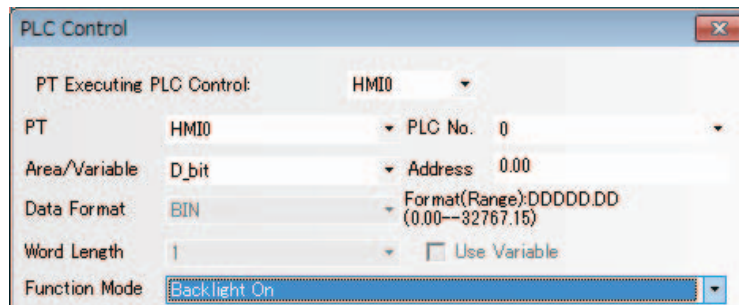

In the settings shown as above, when D\_bit0.00 is ON, and the back light will turn ON. If the user touches D\_bit0.00 again, it will turn OFF, thus returning to the state before the backlight lights on.

## 8 Backlight On (Write Back)

The operation of this option is similar to [Backlight On], but the address of this bit of PLC will be cleared to OFF while the bit address turns ON.

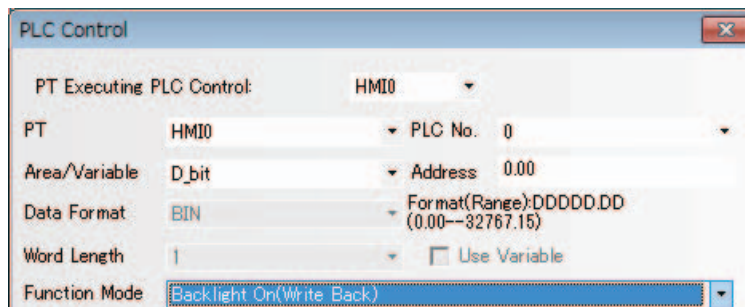

In the settings shown as above, D\_bit0.00 turns OFF automatically as well as the back light turns ON when the D\_bit0.00 turns ON.

## 9 General-purpose PLC Control (Expansion)

General PLC Control (Extend) is similar to General PLC Control, but the occupied address is different, i.e. General PLC Control occupies 4 words while General PLC Control (Extend) occupies 6 words (extending “word” to “double-word”). Refer to the section of General-purpose PLC Control for the details.

The method is as follows:

- (1) Read Address: Similar to General-purpose PLC Control.
- (2) Read Address + 1: Similar to General-purpose PLC Control.
- (3) Read Address + 2: Refers to the address offset of the data memory of PLC during the transmission and it occupies 2 words. Please note that this offset is specified from the address memory with “Read Address + 6”.
- (4) Read Address + 4: Refers to 2 words occupation.

No.	PT No.	Address inform...	PLC Address	Control event
0	0	HMI0:PLC0:0	LW:100	General-purpose PLC cont
1	0	HMI0:PLC0:0	LW:500	General-purpose PLC cont

PLC Control dialog box configuration:

- PT Executing PLC Control: HMI0
- PT: HMI0, PLC No.: 0
- Area/Variable: LW, Address: 100
- Data Format: BIN, Format(Range): DDDDD (0--10255)
- Word Length: 4,  Use Variable
- Function Mode: General-purpose PLC control

PLC Control dialog box configuration (Expansion):

- PT Executing PLC Control: HMI0
- PT: HMI0, PLC No.: 0
- Area/Variable: LW, Address: 500
- Data Format: BIN, Format(Range): DDDDD (0--10255)
- Word Length: 6,  Use Variable
- Function Mode: General-purpose PLC control (Expansion)

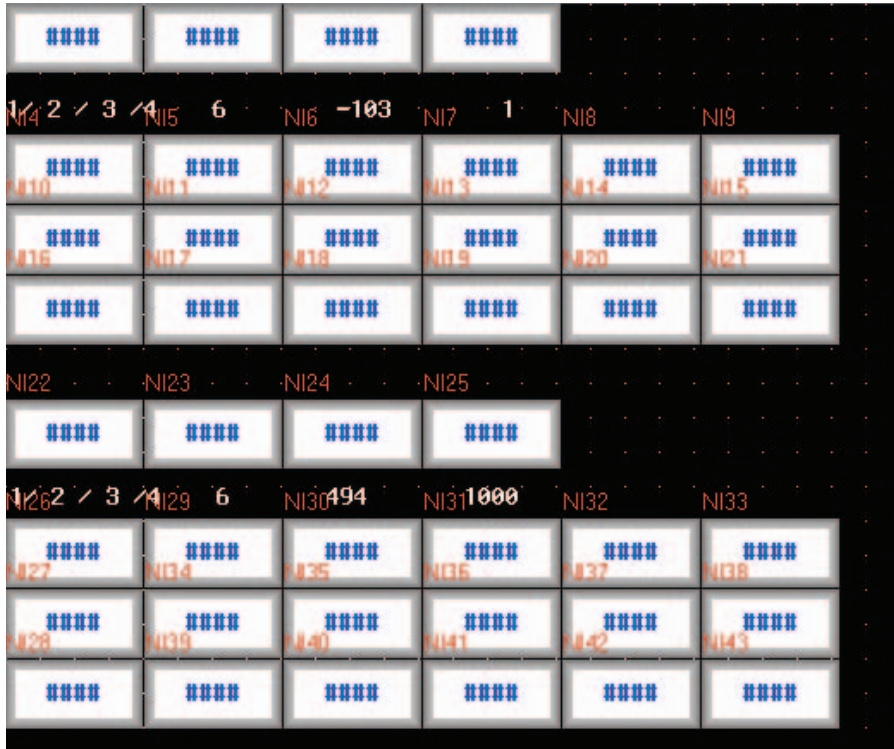

## 10 Change Screen (Ignore screen 0)

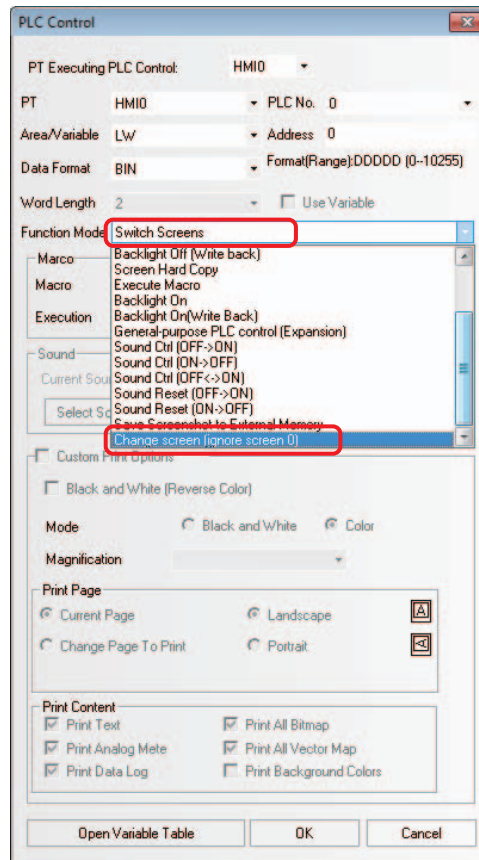

The difference between Switch Screens and Change Screen (Ignore screen 0) is as follows:

**Switch Screens:** When the value of specified address is 0, it will be switched to Screen 0.

**Change Screen (Ignore screen 0):** When the value of specified address is 0, screen switching is not made.

## 3-9 Macro Function

Macro is the function allows the user to create and execute the simple and original programs. The user can add the functions such a arithmetical operations or discriminant of the conditions which are not be supported by the basic functions of the NB-Designer. Using the Macro function, the user also convert the display processing in the screen or the data processing used to be performed in the PLC. This function allows the PC loading reduced. The Macro of the NB-Designer conforms to C Language (ANSI C89).

### 3-9-1 Create a Simple Macro Program

This section provides a brief of the Macro variables.

The Macro variables are classified into two types such as internal variables and external variables.

- Internal variables: The variables are available only within the Macro Program. The internal variables can be defined in the [Macro Variable Table] or the [Macro Editing Window].
- External variables: The variables are to read and write the values with the external controllers. The external variables are necessary to be defined in the [Macro Variable Table] in advance. The defined external variables can be used in the [Macro Editing Window].

Storage Format of the variables used in the [Macro Variables Table]

Storage Format	Data length	Descriptions
Bit	1 bit	Bit variable with 2 statuses of 0 and 1.
Signed short	1 word (16 bits)	Signed short-integer variable with a range of -32768 to 32767.
Unsigned short	1 word (16 bits)	Unsigned short-integer variable with a range of 0 to 65535.
Signed int	2 word (32 bits)	Signed-integer variable with a range of -2147483648 to 2147483647.
Unsigned int	2 word (32 bits)	Unsigned-integer variable with a range of 0 to 4294967295.
Float	2 word (32 bits)	Single-precision floating-point variable with a range of -3.4E+38 to +3.4E38
Double	4 word (64 bits)	Double-precision floating-point variable with a range of -1.79E+308 to +1.79E+308

Read/Write type of Macrocode Variable

Read/Write Type	Descriptions
Read	The values of Macro are read before being executed, and reading operation is not performed during Macrocode execution.
Write	The values of Macro are written to the specified variable at one time after being executed, and writing operation is not performed during Macrocode execution.
Read/Write	The values of Macro are read before being executed, and written after being executed.

Storage Format used in Macro Variable

Data Type	Data length	Descriptions
Bool	1bit	Bit variable with 2 statuses of 0 and 1.
(Signed) char	1byte(8bit)	Signed short-integer variable with a range of -128 to 127.
Unsigned char	1byte(8bit)	Unsigned short-integer variable with a range of 0 to 255.
(Signed) short	1word (16bits)	Signed short-integer variable with a range of -32768 to 32767.
Unsigned short	1word (16bits)	Unsigned short-integer variable with a range of 0 to 65535.
(Signed) int	2word (32bits)	Signed-integer variable with a range of -2147483648 to 2147483647.
Unsigned int	2word (32bits)	Unsigned-integer variable with a range of 0 to 4294967295.
Float	2word (32bits)	Single-precision floating-point variable with a range of -3.4E+38 to +3.4E38
Double	4word (64bits)	Double-precision floating-point variable with a range of -1.79E+308 to +1.79E+308

Create a Macro program with basic arithmetical function in the following figure.

Read 2 signed data from LW0 and LW1, make LW0 divided by LW1, then place the result of the division in the 4 words from LW2 to LW5.

Press the  (Add Macro) icon in the database toolbar, or click [Macro] in the [Option] menu, then the following dialog box will pop up.

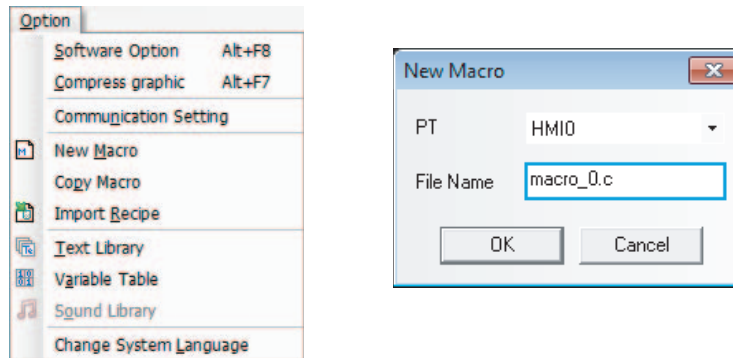

Select the PT No. and input the file name, then click “OK” to enter the Macro Editing Window (i.e. [macro\_0.c]), as shown below.

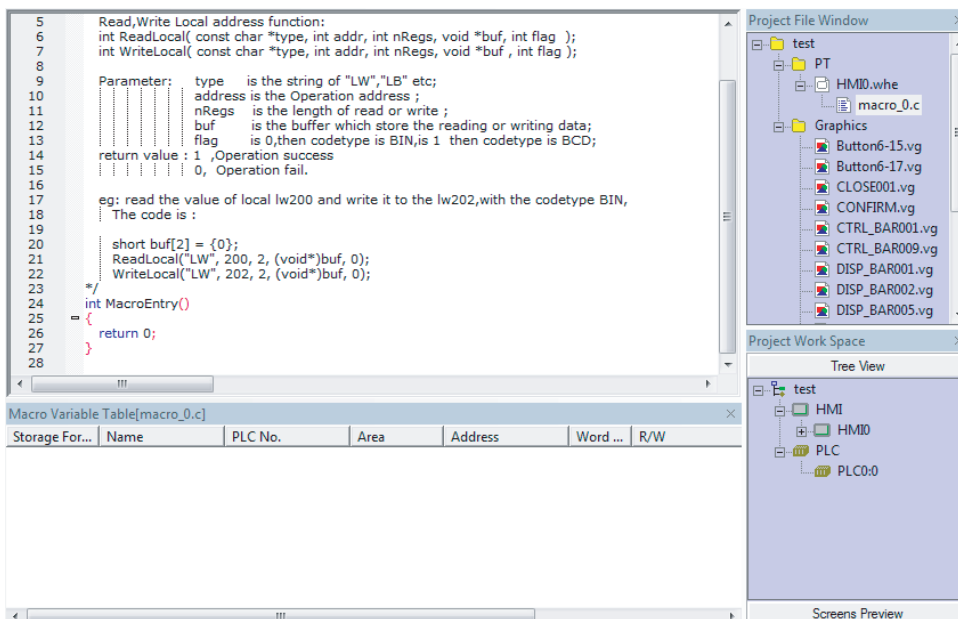

Before writing the Macro, please predefine the I/O variables.

Right-click the mouse in the “Macro Variable Table [macro\_0.c]” window to make the following menu pop up.

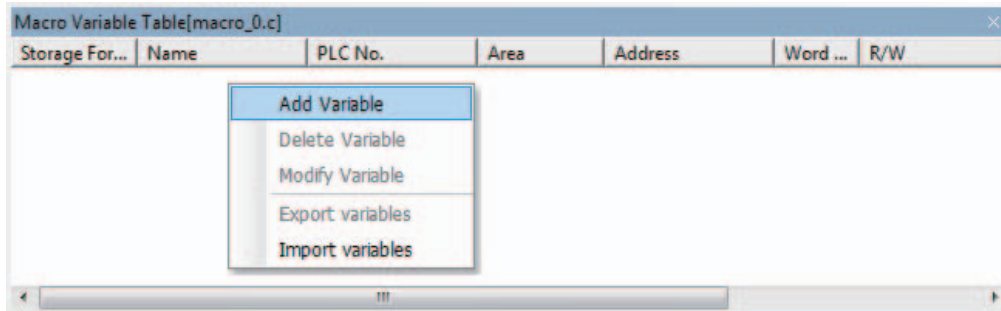

Select “Add Variable” to make the following dialog box pop up.

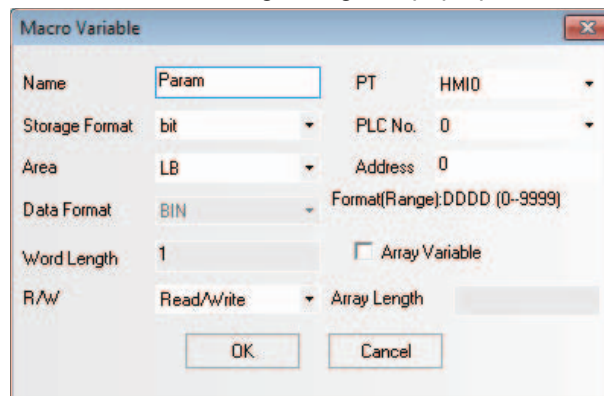

Firstly specify the variable name.

There are 3 kinds of variables - Read variable, Write variable and Read/Write variable. Read variable means Macro will obtain the value of the variable from the specified address; Write variable means the result after the Macro executed will be written into the specified address and Read/Write variable incorporates the features of the Read variable and the Write variable. Therefore, Read, Write and Read/Write are the 3 different variables for the same address. It is recommended to use `_R`, `_W` and `_RW` to differentiate the variables when you specify their names.

In the following example, LW0 and LW1 are Read variables and LW2 is Write variable, so we name them as follows:

LW0\_R, LW1\_R, and LW2\_W. Please note that the regulations for the variable names are consistent with that for C language, and the special attention must be paid to the following points:

- (1) The variable name is case-sensitive;
- (2) The variable name can't be the number or begin with the number or include some special characters such as space, slashes etc.
- (3) The variable name can't be any reserved words of C language.
- (4) Specify the array length in the range from 2 to 1024. The array length of the value in unsigned short type cannot be specified to 4. The array length of the value in int type or float type cannot be specified to 2. (The specification of the function is different from the one of the standard C language)

In the example below, the Properties of LW0\_R are set as follows:

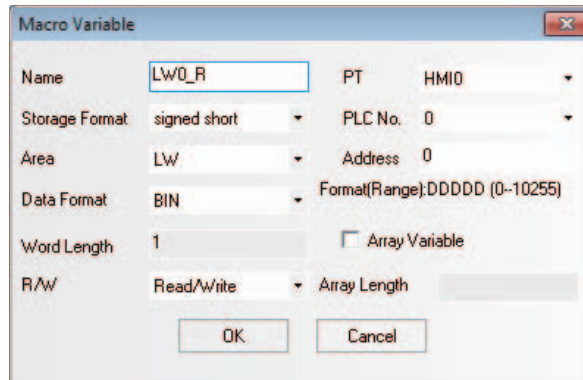

Here, specify “signed int.” from “Storage Format”, “Read” from “R/W”, “LW” from “Area” and “0” from “Address” respectively. After the specification, click the “OK” button, then this variable will be seen in “Macro Variable Table [macro\_0.c]” window.

Storage For...	Name	PLC No.	Area	Address	Word ...	R/W	Array	Array length
signed short	LW0_R		LW	0	1	Read/Write	No	

**Note** The variables used in the Macro are necessary to be registered to the [Macro Variables Table] in advance. Specify LW1\_R and make its address to LW1, then set the address of LW2\_W to LW2 by the same method.

**Note** When the Storage Format is set to “double”, the Word Length will automatically become 4, i.e. this variable will occupy LW2 to LW5.

After the completion of setup, the “Macro Variable Table [macro\_0.c]” window is shown as below:

Storage For...	Name	PLC No.	Area	Address	Word ...	R/W	Array	Array length
signed short	LW0_R		LW	0	1	Read/Write	No	
signed short	LW1_R		LW	1	1	Read	No	
double	LW2_W		LW	2	4	Read/Write	No	

After defining the variables, we should write the following Macro:

```
int MacroEntry()
{
//LW0 is divided by LW1 and LW2 is obtained
LW2_W=LW0_R/LW1_R;
return 0;
}
```

Once it is saved, the simple Macro is completed. At this time, go to the Edit Window to make the editions as shown below:

Place 2 Number Input components corresponding to LW0 and LW1 respectively;

Place 1 text component and enter “/” to represent division.

Place 1 Number Display component corresponding to LW2, and set the Storage Format to “double” (i.e. double-precision floating-point) and both the Integer and Decimal to “4”;



Place 1 Function Key to execute Macro, and select “macro\_0.c” in the drop-down menu as below and input “=” in the label:

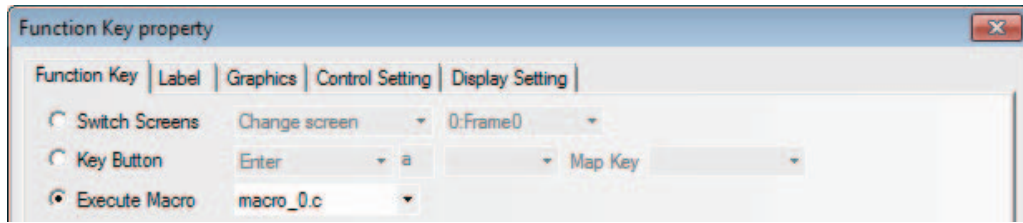

The Edit Window is displayed as follows.

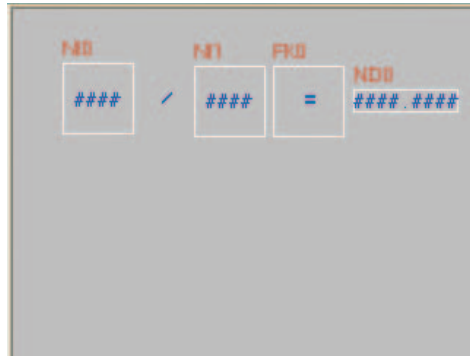

Perform the offline test, input 5 into LW0 and 2 into LW1, and you will see the result as shown below:

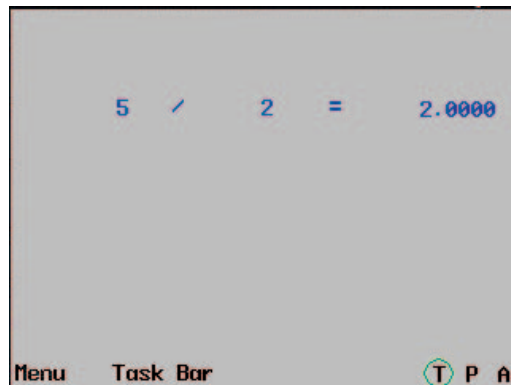

The result should be 2.5000 instead of 2.0000.

LW0\_R and LW1\_R are [signed short] so that the division of one variable by another variable both in integer type results in the variable also in integer type. In order to resolve this problem, the variable to perform the division is necessary to be casted in [double] as follows.

```
LW2_W = (double)(LW0_R)/LW1_R;
```

After editing the Macro in the procedure as the above, perform the test again. Then the result as follows should be out.

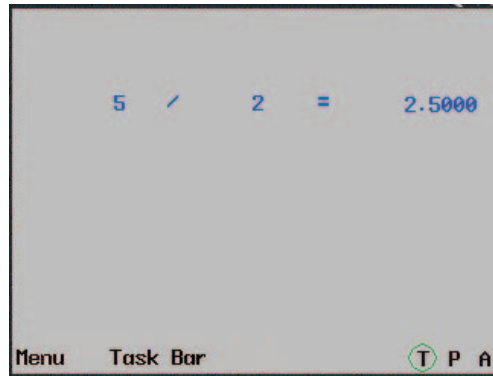

Now the basic specification is completed. However, the Macro still have a problem. When entering “0” into LW1 and executing the Macro, an error occurs and the error can affect the normal operation of the system. In this case, a check should be entered into the operand.

Change the codes shown as below.

```
int MacroEntry()
{
//Judge whether LW1 is 0 or not in order to prevent “Divide-by-zero overflow” ;
if (LW1_R!=0)
//LW0 divides LW1and LW2 is obtained
LW2_W = (double)(LW0_R)/LW1_R;
return 0;
}
```

Execute it again. If the divisor is 0, the Macro will not execute division. Therefore, the program safety will be improved.

### ● Macro Optimization

Create the new Macro with the optional name (test.c). A brief provides of the Macro using the array variables. The array variables can be defined only for the one-dimensional array.

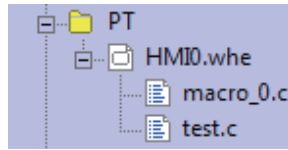

#### For example:

Create one array variable with the length of 8. The definition of variable is shown as below.

```

13  flag is 0,then codetype is BIN,is 1 then codetype is BCD;
14  return value : 1 ,Operation success
15  0, Operation fail.
16
17  eg: read the value of local lw200 and write it to the lw202,with the codetype BIN,
18  The code is :
19
20  short buf[2] = {0};
21  ReadLocal("LW", 200, 2, (void*)buf, 0);
22  WriteLocal("LW", 202, 2, (void*)buf, 0);
23
24  */
25  int MacroEntry()
26  {
27  Param 0 = 0;
28  Param 1 = 1;
29  Param 2 = 2;
30  Param 3 = 3;
31  Param 4 = 4;
32  Param 5 = 5;
33  Param 6 = 6;
34  Param 7 = 7;
35  return 0;
36  }

```

Storage For...	Name	PLC No.	Area	Address	Word ...	R/W	Array	Array length
signed short	Param		LW	0	1	Read/Write	Yes	8

- (1) Place 8 Number Display components LW0 to LW7 with the consecutive addresses in Frame 0, and make the timer to execute "test.c".
- (2) Perform the test, and the values displayed in Number Display components are same as the values assigned in the Macro.



### 3-9-2 Macro and Specification of Operation with Read/Write Variables

In this part, we will provide the description about specification of the operating Macro, and we will also provide the description that should be noted when you use Macro.

The Macro can be regarded as a black box for input and output. Taking the example of the division program which was mentioned in the first part of this section, the flow of the procession is as follows:

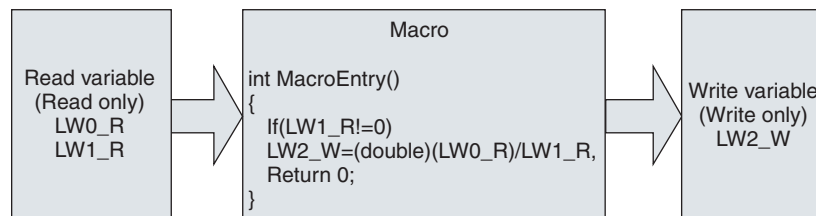

The specification of the operation is as follows: Before the program is executed, the value from the memory for LW0 and LW1 will be assigned to Read variables LW0\_R and LW1\_R, then Macro will be executed. Later, after Macro function returns, the value of variable LW2\_W will be written into LW2.

Therefore, the variables of the Macro performs like the copy of the memory and even if the variables are modified, the value of the memory is not be changed.

- Note 1** Since the read variables do not read the memory value during executing the Macro, the read value remain the same as the one when the Macro read during operating. Even if the memory value is modified from the external device during the Macro executing, result of the operation is not be affected.
- 2 Even if the memory value is written with a value from the external device during the Macro executing, the memory value will be updated to the result of the execution of the Macro after the Macro completed.
  - 3 The read variable is read only and the write value is write only. Therefore, writing the value to the read variable or reading the writing variable by using the Macro are not impossible. Similarly, when one address is used for reading and writing at the same time, use two different names by contrast for the variables such as LW0\_R and LW0\_W for LW0.
  - 4 The global variables or the static variables are not available in the Macro. If the data should be retained using the global variables, use the PT internal memories such as LW or LB.
  - 5 The values which output the result of the Macro should be prepared.

**The description of the other functions are provided as follows.**

(a) Modify or delete the variable in Macro.

Open the [Project File Window] and double-click the Macro file corresponded to open the [Macro Variables Table] dialog box. Right-click the variable to select [Delete variable] or [Modify Variable].

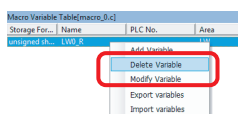

Right-click the variable to select [Delete variable] or [Modify Variable]

Please be careful because the deleted variables can't be restored.

(b) Delete the whole Macro file.

Open the Project File Window, press "Delete" key after selecting the corresponding Macro file.

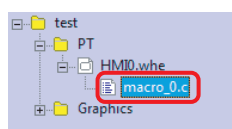

Select and press "Delete" key.

Please be careful because the deleted Macro files can't be restored.

### 3-9-3 Macro Triggering

There are many flexible methods for triggering Macro. Using the triggering methods for Macro flexibly can realize more flexible and powerful functions conveniently.

NB-Designer currently supports the following methods for triggering Macro:

#### 1 Macro when loading project

Check the “Use Macro when loading project” check box in the “PT Extended Properties” tab.

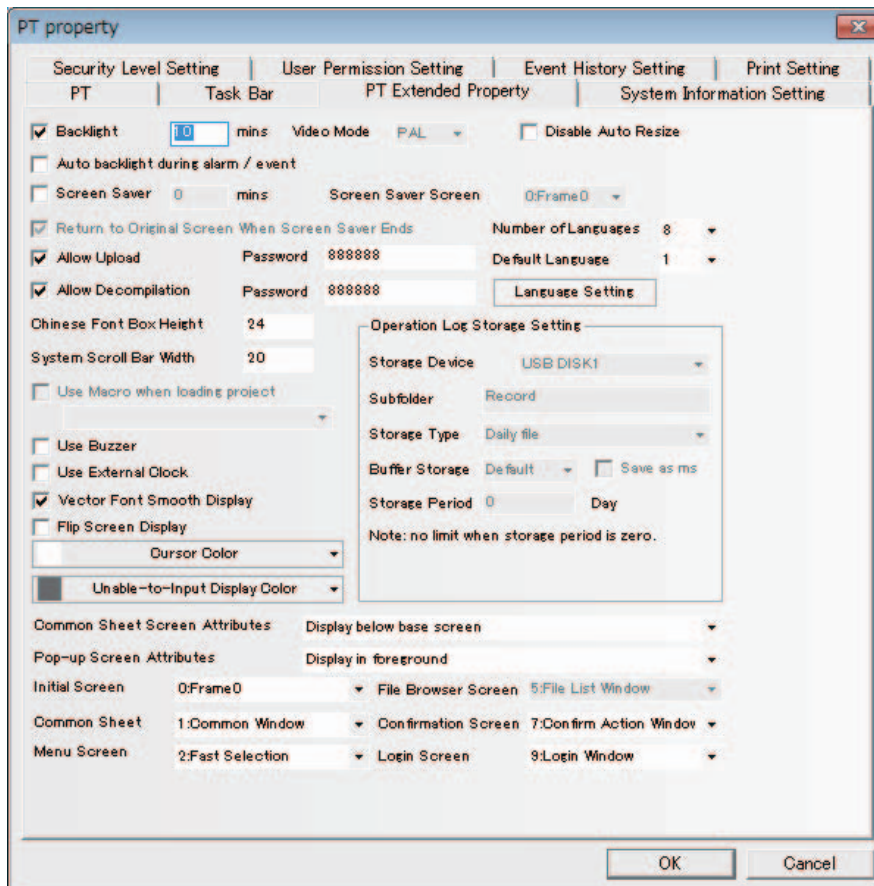

#### 2 Function Key

Using “Execute Macro” function of Function Key to trigger the Macro is a kind of common triggering method.

#### 3 Timer

Executing the [Execute Macro] function by the Timer function allows the combination of the Macro and the Timer function.

## 4 PLC Control

Specify the PLC Control as follows and select the [Execute Macro] and then the Macro will be executed when the specific bits are matched to the condition previously specified.

PLC Control

PT Executing PLC Control: HMIO

PT: HMIO PLC No.: 0

Area/Variable: LB Address: 0

Data Format: BIN Format(Range):DDDD (0-9999)

Word Length: 1 Use Variable:

Function Mode: Execute Macro

Marco

Macro: macro\_0.c

Execution: ON <-> OFF

## 5 Event

Setting the [Execute Macro] as below allows the Macro execution when a certain condition is satisfied.

Event Setting

Triggered PT: HMIO Type: 0

Address

PT: HMIO PLC No.: 0

Memory Type: Bit

Area/Variable: LB Address: 0

Format(Range):DDDD (0-9999)

Data Format: BIN Use Variable:

Attribute

Detection Pattern:  On  Off

Condition: < 0

Value Range:  Min Value: 0 Max Value: 0

Print:  On Trigger  Return to Normal

Function

Execute Macro: macro\_0.c

Pop-up Screen: 0:Frame0

Confirm Dialog:  Trigger Dialog

Write Value: 0

PT: HMIO PLC No.: 0

Area/Variable: LB Address: 0

Use Variable

Format(Range):DDDD (0-9999)

Use Buzzer: Buzzing Time: 1 Sec.

Message

Temperature is too high!

Use Text Library

Language: Language1 Font

Use Vector Font: Font

Sound

Use Sound: Select Sound

Play Stop

Open Text Library Open Variable Table OK Cancel

## 6 Control Setting of component

Checking [Macro] of Triggering action in the tab [Control Setting] as the lower figure shown allows the Macro to be executed when the component is touched.

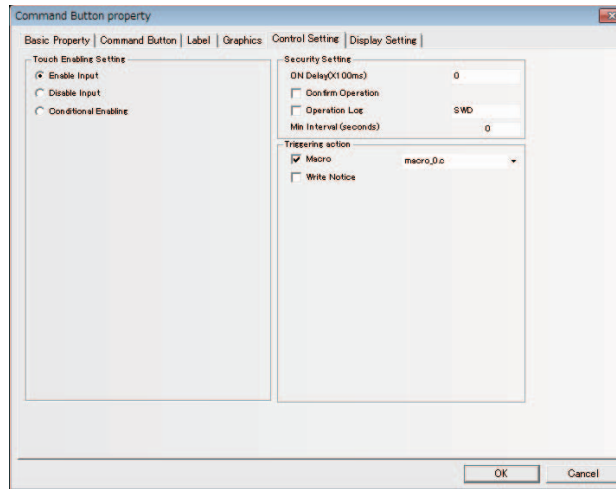

### 3-9-4 Other Descriptions

**1** The Macro Editing Window can display the emphasis of the keywords.

In the top of the default Macro, a demo program is described for explanation.

```

1  #include "macrotypedef.h"
2  #include "math.h"
3
4  = /*
5  Read,Write Local address function:
6  int ReadLocal( const char *type, int addr, int nRegs, void *buf, int flag );
7  int WriteLocal( const char *type, int addr, int nRegs, void *buf , int flag );
8
9  Parameter:  type   is the string of "LW","LB" etc;
10             address is the Operation address ;
11             nRegs   is the length of read or write ;
12             buf     is the buffer which store the reading or writing data;
13             flag    is 0,then codetype e is BIN,is 1 then codetype is BCD;
14 return value : 1 ,Operation success
15             : 0, Operation fail.
16
17 eg: read the value of local lw200 and write it to the lw202,with the codetype BIN,
18 The code is :
19
20 short buf[2] = {0};
21 ReadLocal("LW", 200, 2, (void*)buf, 0);
22 WriteLocal("LW", 202, 2, (void*)buf, 0);
23 */
24 int MacroEntry()
25 = {
26     return 0;
27 }
28

```

If the entity part of the Macro program is copied and pasted in the following figure, you can see that the color of the keywords is changed. The short/void are colored in blue and the LW is colored in red. The part enclosed by “/\*” and “\*/” is the comment.

```

1  #include "macrotypedef.h"
2  #include "math.h"
3
4  = /*
5  Read,Write Local address function:
6  int ReadLocal( const char *type, int addr, int nRegs, void *buf, int flag );
7  int WriteLocal( const char *type, int addr, int nRegs, void *buf , int flag );
8
9  Parameter:  type   is the string of "LW","LB" etc;
10             address is the Operation address ;
11             nRegs   is the length of read or write ;
12             buf     is the buffer which store the reading or writing data;
13             flag    is 0,then codetype e is BIN,is 1 then codetype is BCD;
14 return value : 1 ,Operation success
15             : 0, Operation fail.
16
17 eg: read the value of local lw200 and write it to the lw202,with the codetype BIN,
18 The code is :
19
20 short buf[2] = {0};
21 ReadLocal("LW", 200, 2, (void*)buf, 0);
22 WriteLocal("LW", 202, 2, (void*)buf, 0);
23 */
24 int MacroEntry()
25 = {
26     short buf[2] = {0};
27     ReadLocal("LW", 200, 2, (void*)buf, 0);
28     WriteLocal("LW", 202, 2, (void*)buf, 0);
29     return 0;
30 }
31

```



- 2** After the Macro creation, you can rename the Macro.

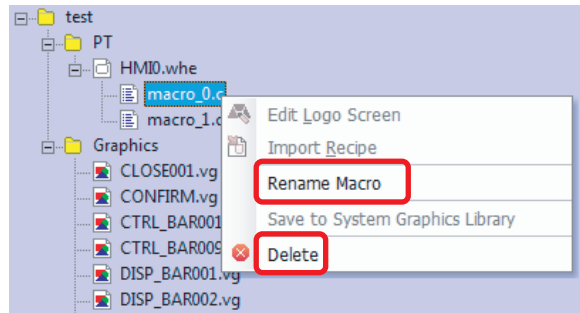

Right-click the Macro name, and you can see the options of [Rename Macro] and [Delete], and input the new name after the dialog box pops up after clicking “Rename Macro”.

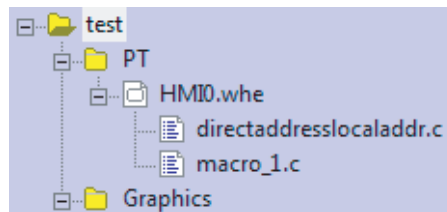
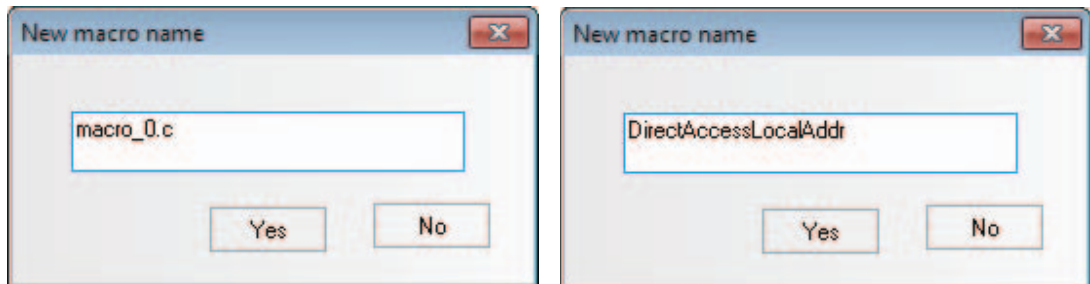

- 3** It supports the direct access to the local address of the PT without defining the variables.

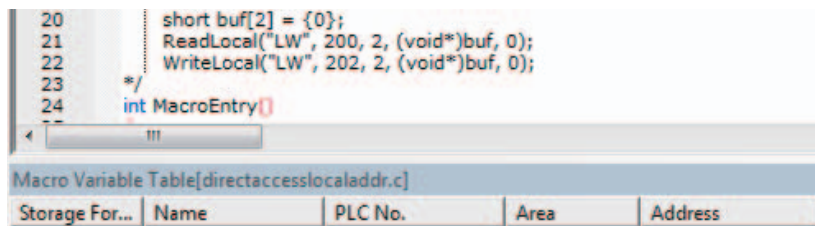

As shown above, even if no variables are defined in the Macro, the direct access to the local address of the PT, i.e. reading or writing the local address.

```
int ReadLocal(const char *type, int addr, int nRegs, void *buf, int flag);
```

```
int WriteLocal(const char *type, int addr, int nRegs, void *buf, int flag);
```

“nRegs” refers to number of words. That’s to say, the program will read 2-word data beginning from LW200 and then write 2 words to LW202. In order to confirm this code segment will be executed successfully, you should place 4 Number Input components and 1 Function Key to execute the Macro in the Edit window, as shown below:



Perform the offline test:

Make LW200=1 and LW201=2, then click the [Macro] button, and you will find LW202=1 and LW203=2. The Macro is executed normally.

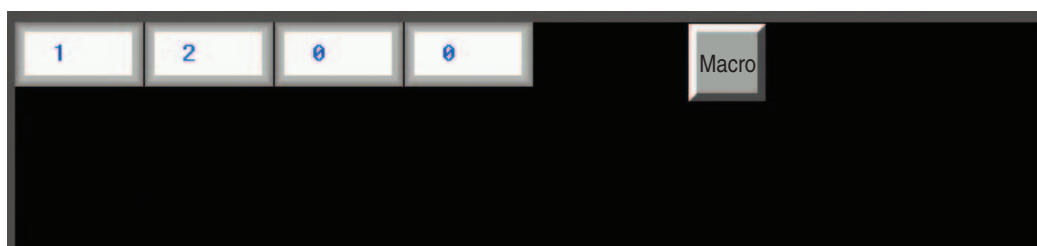

**4** [Import variable/Export variable] functions are provided for user to copy Macro variables and Macro.

Right-click “Macro Variable Table [directaccesslocaladdr.c]”, you will see the [Import variables] option; and you will see the [Export variables] option is also valid after you have created a new variable.

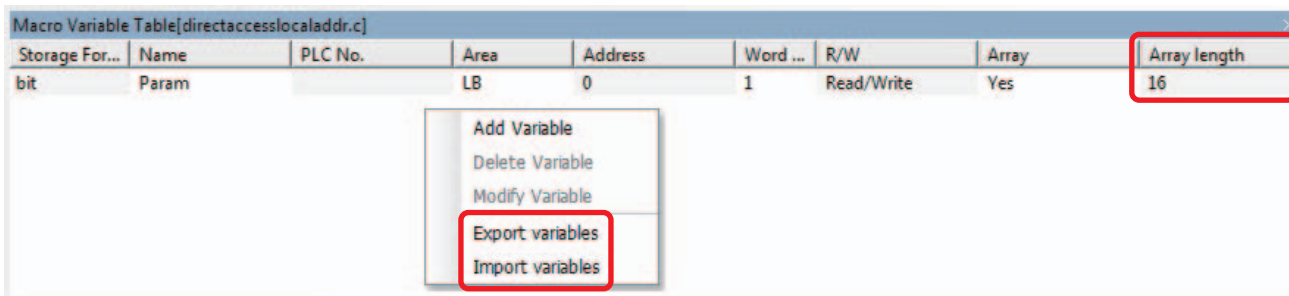
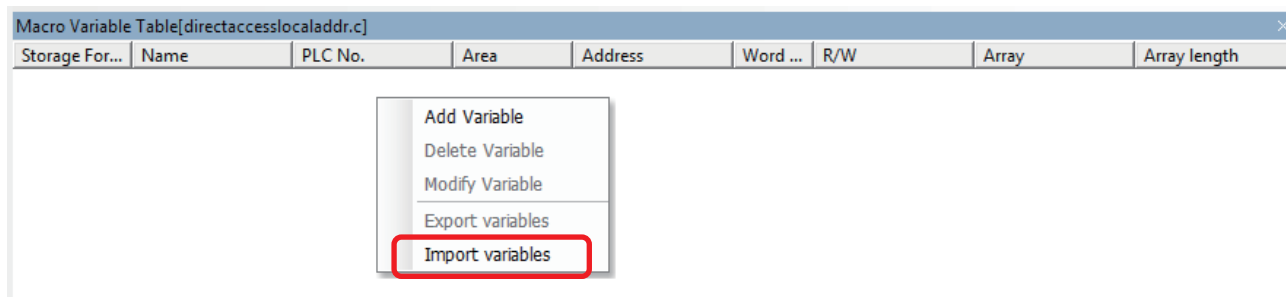

First click the [Export variables] option to make “Save As” dialog box, and input the file name “t” with the extension as “.MPL”, then save it into the optional folder.

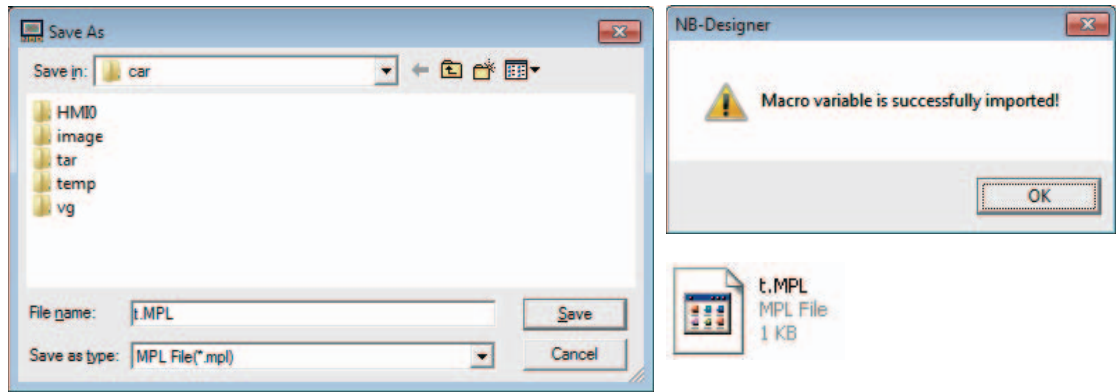

Clicking the [Delete Variable] option and the [Import Variables] option allows the importing variables. Such operation can be made among the different projects. Select the code which should be copied if it is a program and right-click the [Copy] followed by pasting the code to the intended location.

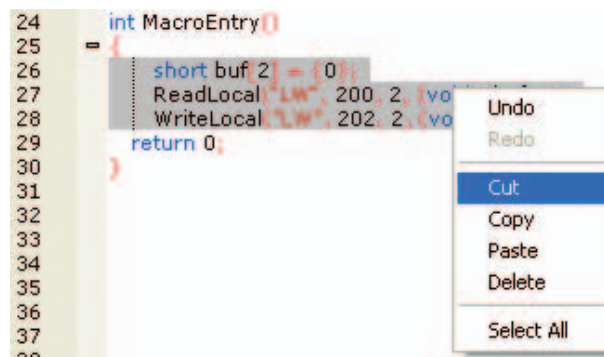
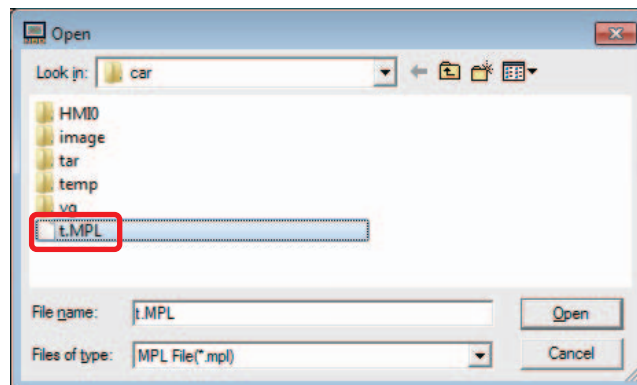
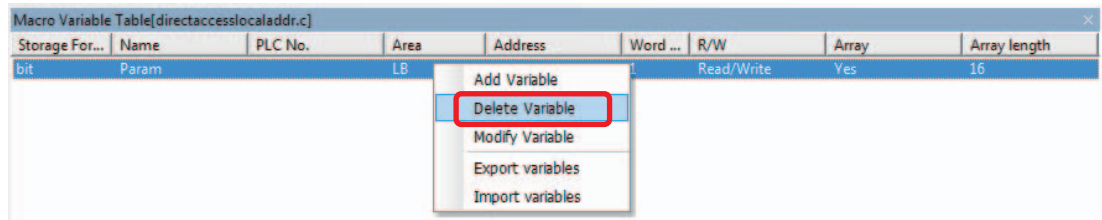

**5** It supports the array variables in bit format.

```

24 int MacroEntry()
25 = (
26     int i = 0;
27     short buf[2] = {0};
28     ReadLocal("LW", 200, 2, (void*)buf, 0);
29     WriteLocal("LW", 202, 2, (void*)buf, 0);
30     for(i=0; i<16; i++)
31         Param[i] = 1;
32     return 0;

```

Storage For...	Name	PLC No.	Area	Address	Word ...	R/W	Array	Array length
bit	Param		LB	0	1	Read/Write	Yes	16

Prepare array variables in bit format allocated L.W.B. 0.0 to 0.f and create a Macro which writes "1" to all the elements in the array. Place 16 Bit Switches with the addresses of LW.B 0.0~0.f as well as 1 binary Number Input component with the address of LW0.



Perform the offline test:

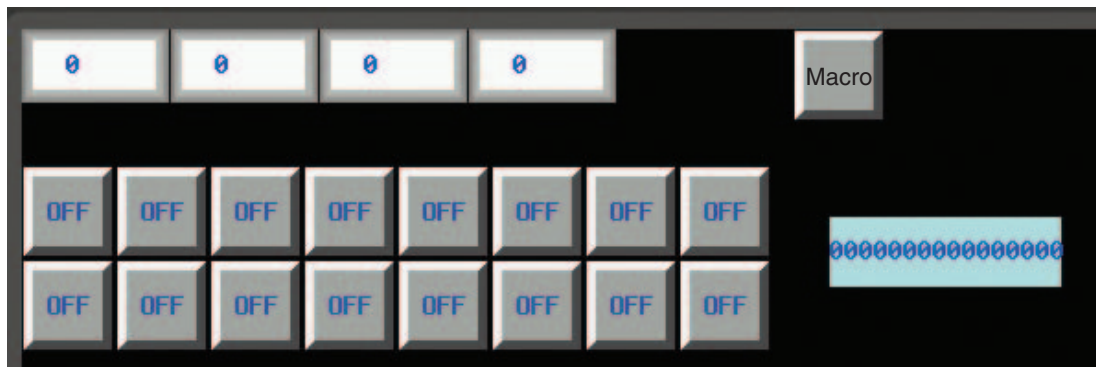

After [Macro] is clicked, the display will be shown as below:

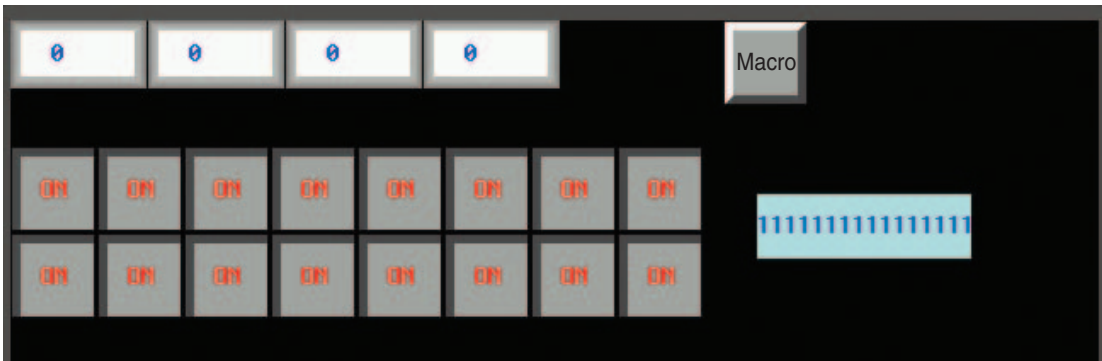

## 6 Supports Direct Drawing in the Screen (Description of PT Drawing Function)

The Macro executing function allows the user to call drawing function.

Drawing functions adopt rectangular coordinate system of screen: point of origin locates in the upper-left corner, and the X-axis extends rightward while the Y-axis extends downward.

### (1) Definition of Struct

Add 3 structs: PenParam, BrushParam and Point.

#### (a) Pen structure "PenParam"

```
typedef struct penparam
{
    short type;
    short width;
    int color;
}PenParam;
```



PenParam is mainly used to set the type, width and the color Properties of the pen. And the value range is as follows.























Parameter Name	Value	Descriptions
Type (Pen type)	PS_NULL	No pen
	PS_SOLID	Smooth line ( ————— )
	PS_DASH	Dash line ( — — — — )
	PS_DOT	Dot line ( . . . . . )
	PS_DASHDOT	Dash-dotted line ( - - — - - )
	PS_DASHDOTDOT	Dot-dotted line ( - - . — - - )
Width (Pen Size)	1~8 (Unit: pixel)	If the input value is less than the minimum value 1 or greater than the maximum value 8, the system will automatically set it to the minimum value or the maximum value respectively.
Color (Pen Color)	0~65535	It is recommended to use Macro RGB (r, g, b) to set the color, and the range for r, g and b is 0~255. The system will convert the value of RGB (r, g, b) according to the color parameters of PT screen.







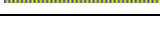

#### (b) Brush Structure "BrushParam"





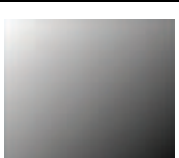

```
typedef struct brushparam
{
    int type;
    int foreColor;
    int backColor;
}BrushParam;
```

BrushParam is mainly used to set the type of the brush, the foreground color and background color. Brush type is mainly used to set the filling styles used by the brush: graphics-filling and gradient-filling. And the value range is as follows.

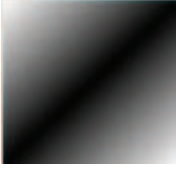
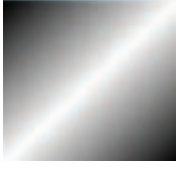

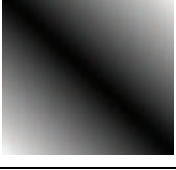
Parameter Name	Value	Descriptions
Type (Brush type)	BFS_NOBRUSH	No filling
	BFS_SOLID	
	BFS_DENSE1	

Parameter Name	Value	Descriptions
	BFS_DENSE2	
	BFS_DENSE3	
	BFS_DENSE4	
	BFS_DENSE5	
	BFS_DENSE6	
	BFS_DENSE7	
	BFS_DENSE8	
	BFS_DENSE9	
	BFS_DENSE10	
	BFS_DENSE11	
	BFS_DENSE12	
	BFS_FDIAG1	
	BFS_BDIAG1	
	BFS_FDIAG2	
	BFS_BDIAG2	
	BFS_FDIAG3	
	BFS_BDIAG3	
	BFS_VER1	
	BFS_HOR1	
	BFS_VER2	
	BFS_HOR2	
	BFS_VER3	
	BFS_HOR3	
	BFS_DIAGCROSS	
	BFS_CROSS	
	BFS_HORGRDT_FTTD	

Parameter Name	Value	Descriptions
	BFS_HORGRDT_FDTT	
	BFS_HORGRDT_FETC	
	BFS_HORGRDT_FCTE	
	BFS_VERGRDT_FLTR	
	BFS_VERGRDT_FRTL	
	BFS_VERGRDT_FETC	
	BFS_VERGRDT_FCTE	
	BFS_OUPGRDT_FLTRD	
	BFS_OUPGRDT_FRDTLT	

Parameter Name	Value	Descriptions
	BFS_OUPGRDT_FETC	
	BFS_OUPGRDT_FCTE	
	BFS_ODWNGRDT_F RTTLD	
	BFS_ODWNGRDT_F LDTRT	
	BFS_ODWNGRDT_F ETC	
	BFS_ODWNGRDT_F CTE	
	BFS_CONGRDT_FLT TRD	
	BFS_CONGRDT_FRT TLD	
	BFS_CONGRDT_FR DTLT	



Parameter Name	Value	Descriptions
	BFS_CONGRDT_FLD TRT	
	BFS_CENGRDT_FETC	
	BFS_CENGRDT_FCTE	
ForeColor (Pattern color)	0~65535	It is recommended to use Macro RGB (r, g, b) to set the color, and the range for r, g and b is 0~255. The system will convert the value of RGB (r, g, b) according to the color parameters of PT screen.
BackColor (Background color)	0~65535	It is recommended to use Macro RGB (r, g, b) to set the color, and the range for r, g and b is 0~255. The system will convert the value of RGB (r, g, b) according to the color parameters of PT screen.

## (c) Point Structure "Point"

The parameter of point structure is simpler: x represents the X-axis coordinate and y represents the Y-axis coordinate for the point.

**Additional Information**

To specify the color with a RGB function, you need to specify r and b as a multiples of 8, and specify g as a multiples of 4. The remainder will be rounded down. If you specify 0 for r, g, and b, the transparent color is specified. To draw a black line, you need to specify the value except 0 as you do for RGB (8, 0, 0).

## (1) Drawing Function

## (a) Rectangle "DrawRect (x, y, w, h, pen, brh)"

The description of the parameter is as follows:

Parameter	Type	Descriptions
x	Int.	X-axis coordinate of the upper-left corner of the rectangle (Unit: pixel)
y	Int.	Y-axis coordinate of the upper-left corner of the rectangle (Unit: pixel)
w	Int.	Rectangle width (Unit: pixel)
h	Int.	Rectangle height (Unit: pixel)
pen	PenParam	Rectangular-border pen
brh	BrushParam	Rectangular filling brush

## (b) Rounded Rectangle “DrawRndRect (x, y, w, h, radius, pen, brh)”

The description of the parameter is as follows:

Parameter	Type	Descriptions
x	Int.	X-axis coordinate of the upper-left corner of the rectangle (Unit: pixel)
y	Int.	Y-axis coordinate of the upper-left corner of the rectangle (Unit: pixel)
w	Int.	Rectangle width (Unit: pixel)
h	Int.	Rectangle height (Unit: pixel)
radius	Int.	Rounded radius (Unit: pixel)
pen	PenParam	Rounded-rectangle-border brush
brh	BrushParam	Rounded-rectangle filling brush

## (c) Ellipse “DrawEclips (x, y, w, h, pen, brh)”

The description of the parameter is as follows:

Parameter	Type	Descriptions
x	Int.	X-axis coordinate of the upper-left corner of the circumscribed rectangle of ellipse (Unit: pixel)
y	Int.	Y-axis coordinate of the upper-left corner of the circumscribed rectangle of ellipse (Unit: pixel)
w	Int.	Width of the circumscribed rectangle of ellipse (Unit: pixel)
h	Int.	Height of the circumscribed rectangle of ellipse (Unit: pixel)
pen	PenParam	Ellipse-border pen
brh	BrushParam	Ellipse-filling brush

## (d) Line “DrawLine (x1, y1, x2, y2, pen)”

The description of the parameter is as follows:

Parameter	Type	Descriptions
x1	Int.	X-axis coordinate of line origin (Unit: pixel)
y1	Int.	Y-axis coordinate of line origin (Unit: pixel)
x2	Int.	X-axis coordinate of line end (Unit: pixel)
y2	Int.	Y-axis coordinate of line end (Unit: pixel)
pen	PenParam	Line brush

## (e) Polygon “DrawPolyg (pts, n, pen, brh)”

The description of the parameter is as follows:

Parameter	Type	Descriptions
pts	Point *	The first address of vertex-coordinate data for polygon
n	Int.	Vertex data of the polygon
pen	PenParam	Polygon-border pen
brh	BrushParam	Polygon-filling brush

## (f) Arc “DrawArc (x, y, w, h, start, end, pen)”

The description of the parameter is as follows:

Parameter	Type	Descriptions
x	Int.	X-axis coordinate of the upper-left corner of the circumscribed rectangle of arc (Unit: pixel)
y	Int.	Y-axis coordinate of the upper-left corner of the circumscribed rectangle of arc (Unit: pixel)
w	Int.	Width of the circumscribed rectangle of arc (Unit: pixel)
h	Int.	Height of the circumscribed rectangle of arc (Unit: pixel)
start	Int.	The starting angle of the arc (Unit: degree)
end	Int.	The end angle of the arc (Unit: degree)
pen	PenParam	Arc-border pen

## (g) Sector “DrawPie (x, y, w, h, start, end, pen, brh)”

The description of the parameter is as follows:

Parameter	Type	Descriptions
x	Int.	X-axis coordinate of the upper-left corner of the circumscribed rectangle of sector (Unit: pixel)
y	Int.	Y-axis coordinate of the upper-left corner of the circumscribed rectangle of sector (Unit: pixel)
w	Int.	Width of the circumscribed rectangle of sector (Unit: pixel)
h	Int.	Height of the circumscribed rectangle of sector (Unit: pixel)
start	Int.	The starting angle of the sector (Unit: degree)
end	Int.	The end angle of the sector (Unit: degree)
pen	PenParam	Sector-border pen
brh	BrushParam	Sector-filling brush

For the drawing functions, RGB values can be used directly for the colors.

For the corresponding relationship between 65536 Color and RGB, the system will handle it directly.

```
int MacroEntry()
{
  PenParam pen;
  BrushParam brh;
  Point pts[5];
  short buf[2] = {0};

  pts[0].x = 0;
  pts[0].y = 0;
  pts[1].x = 100;
  pts[1].y = 0;
  pts[2].x = 120;
  pts[2].y = 150;
  pen.type = 1;
  pen.width = 0;
  pen.color = RGB(0, 0, 0xFF);
  brh.type = BFS_ODWNGRDT_FRTTLD;
  brh.foreColor = RGB(0, 0, 0);
  brh.backColor = RGB(255, 255, 255);
  DrawRect(0, 0, 400, 400, pen, brh);
}
```

## 7 Example of how to use the local variable functions

When the Macro is created as below, the variables read from the value LB100 and LB101 (in the PT local memory) are written to LB102 and LB103 (in the PT local memory).

The codes are compiled as follows:

```

24  int MacroEntry()
25  = {
26      _Bool buf[2] = {0};
27      ReadLocal("LB", 100, 2, (void*)buf, 0);
28      WriteLocal("LB", 102, 2, (void*)buf, 0);
29      return 0;
30  }
31

```

Where,

The "buf" is defined as "\_Bool", and it can also be defined as "short" because each bit address in local LB memories occupies one-word (16 bit) space (but in fact only one bit in each word is used.)

ReadLocal("LB", 100, 2, (void\*)buf, 0) indicates that the values read from LB100 and LB101 are written to buf[0] and buf[1], respectively. "2" located in the center of the parenthesis indicates the number of bit that the LB100 reads.

WriteLocal ("LB", 102, 2, (void\*)buf, 0) indicates that writes the read values to LB102 and LB103, respectively.

Firstly, add 2 Bit Switch components with addresses of LB100 and LB101, and then add 2 Bit Lamp components with addresses of LB102 and LB103. Finally, add a Function Key to execute the Macro.

After the Save and Compile operations are performed, then execute the Macro:

After the LB100 and LB101 are turned ON, when the Macro is executed, you can see the LB102 and LB103 are turned ON.

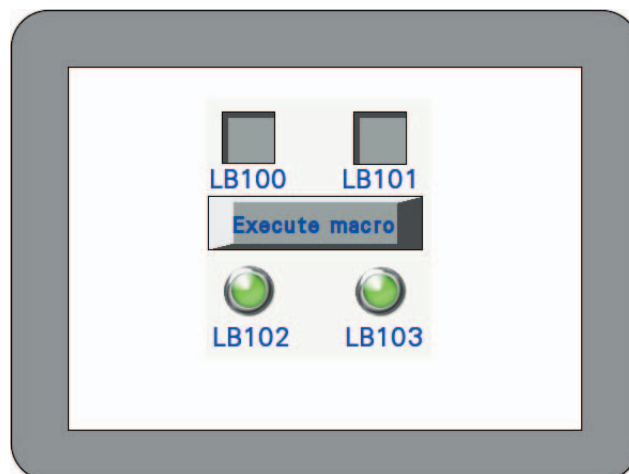

#### **8** Available standard functions

Following standard functions of C language is available. Refer to a commercial handbook of C language for the details.

sin (double)

cos (double)

tan (double)

sinh (double)

cosh (double)

tanh (double)

asin (double)

acos (double)

atan (double)

atan2 (double, double)

exp (double)

log (double)

log10 (double)

pow (double, double)

sqrt (double)

ceil (double)

floor (double)

fabs (double)

ldexp (double, int)

frexp (double, int\*)

modf (double, double\*)

fmod (double, double)

isgreater(x, y)

isgreaterequal(x, y)

isless(x, y)

islessequal(x, y)

islessgreater(x, y)

isunordered(x, y)

## 3-10 System Parameters

Specifications related to the NB units are performed in the PT Property.

The PT Property can specify the procedure to display the PT screens and the system specifications of the PT units as well as the communications settings.

Double-clicking PT in Configuration and Setup Window can make system parameter dialog box pop up.

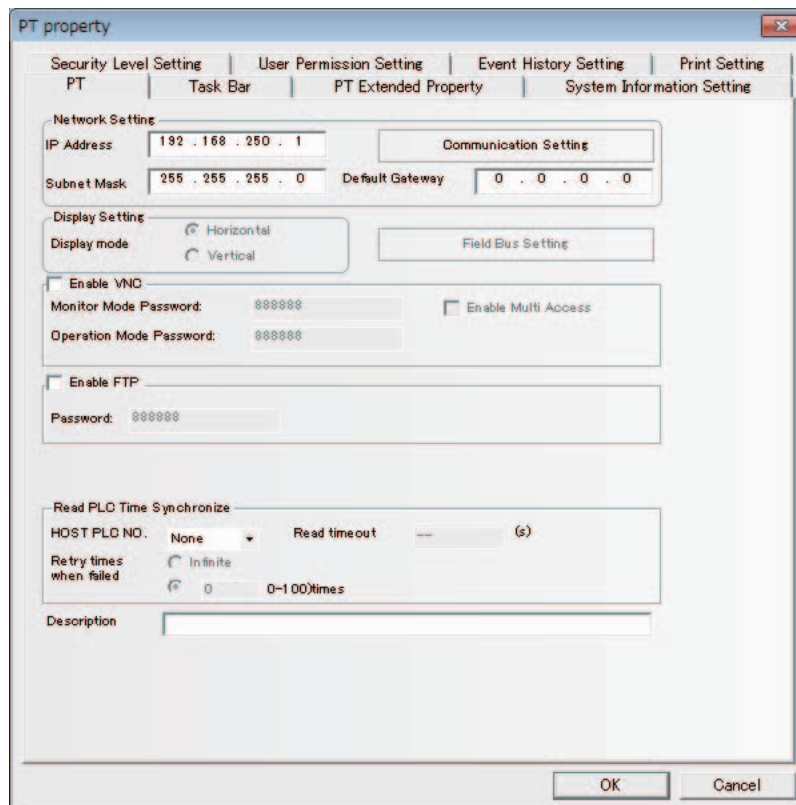

There are 8-9 tabs related to the communication: [PT], [Task Bar], [PT Extended Properties], [System Information Setting], [User Permission Setting], [Security Level Setting], [Event History Setting], [Print Setting], and [COM1 Setting]. They will be described in the later one by one.

## 3-10-1 PT

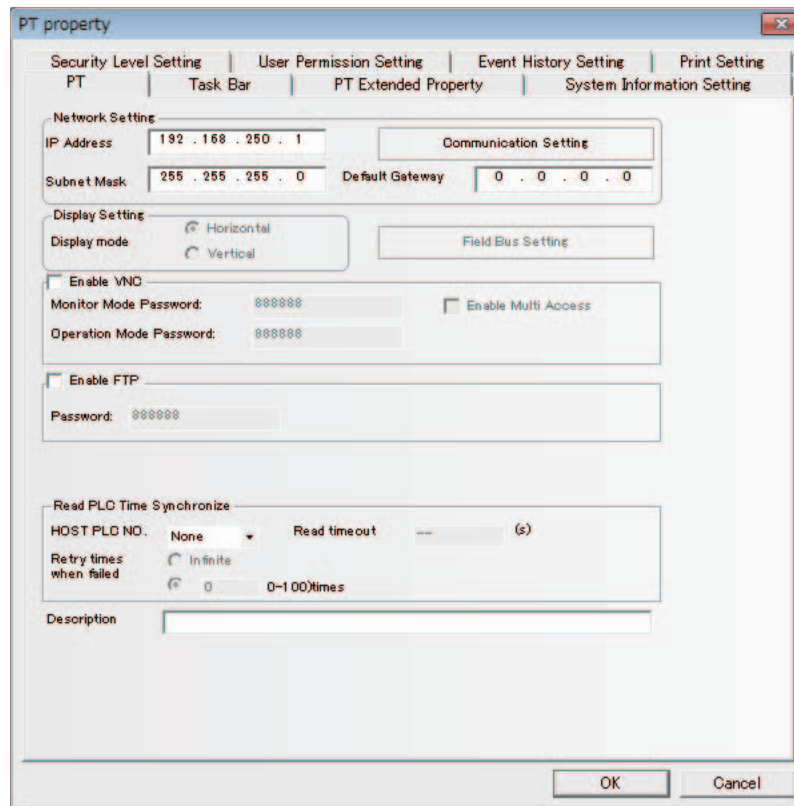

**Network Setting:** Refers to the network information such as IP Address, Subnet Mask, Default Gateway and Display Setting etc. This setting is greyed out on models that do not support Ethernet ports.

**Display Setting:** Refers to the current display of PT (Horizontal or Vertical). Horizontal/Vertical display is selected at dragging PT, once it is selected, it will not be switched again.

**Enable VNC:** Check the check box to enable VNC server function. VNC server status can be checked by LB9290. Monitor mode and operation mode can be enabled/disabled by LB9291 - LB9293.

**Monitor Mode Password / Operation Mode Password:**

For VNC server function, a password setting is required for monitor mode and operation mode, respectively. The default is 888888. The password only supports the number instead of the other characters. The password ranges from 0 to 4294967295.

**Enable Multi Access:** Check the check box to enable simultaneous multi client access. Simultaneous access from multiple clients will deteriorate the performance of the NB. As a preventive measure, check the load status on the processing and adjust the load within the appropriate range when you use this option.

**Enable FTP:** Check the check box to enable FTP server function. For FTP server function, a password setting is required. The default is 888888. The password only supports the number instead of the other characters. The password ranges from 1 to 99999999. FTP server status can be checked by LB9296.

**Read PLC Time Synchronize:** Acquire clock information from a specified host and set as the System Time.

**Description:** Refers to the description for this PT. And the description will be displayed in PT description box at the downloading and test etc., thus making the differentiation among several PTs conveniently.



**Example:** Acquire the System Time from a PLC with retry enabled.

Specify the PLC whose System Time is to be acquired in "HOST PLC NO.".

In "Retry times when failed", specify the number of retries to be made if acquisition of the System Time fails.

When set to "Infinite", retries are attempted until the System Time is successfully acquired. When set to 0, only one attempt is made to acquire the System Time at startup. If the attempt fails, no retries are made.

In "Read timeout", specify the wait time in seconds for a response to the acquire clock command. If you want to change the setting so as to read the timeout time specified in the Communication Settings, change in the Communication Settings.

By configuring these settings, the NB-S Series automatically acquires the System Time from the specified host at startup, and starts running using the acquired clock time. The NB-S series does not retain an internal clock. If this setting is not specified, operation starts from Jan 1, 2000, 0 hours, 0 minutes, 0 seconds.

**Note** The Data Log, XY Graph, and Data History functions stop while clock information is being acquired. These functions start at the point that the clock information is successfully acquired. The functions also start when the clock information acquisition process makes the set number of retry attempts or an error occurs. If an error occurs, operation starts from Jan 1, 2000, 0 hours, 0 minutes, 0 seconds.

**Note** This function does not operate in the simulator. (The simulator operates using the PC clock.)

## 3-10-2 Task Bar

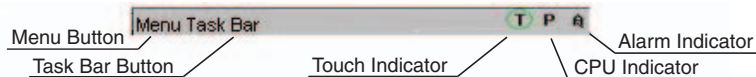
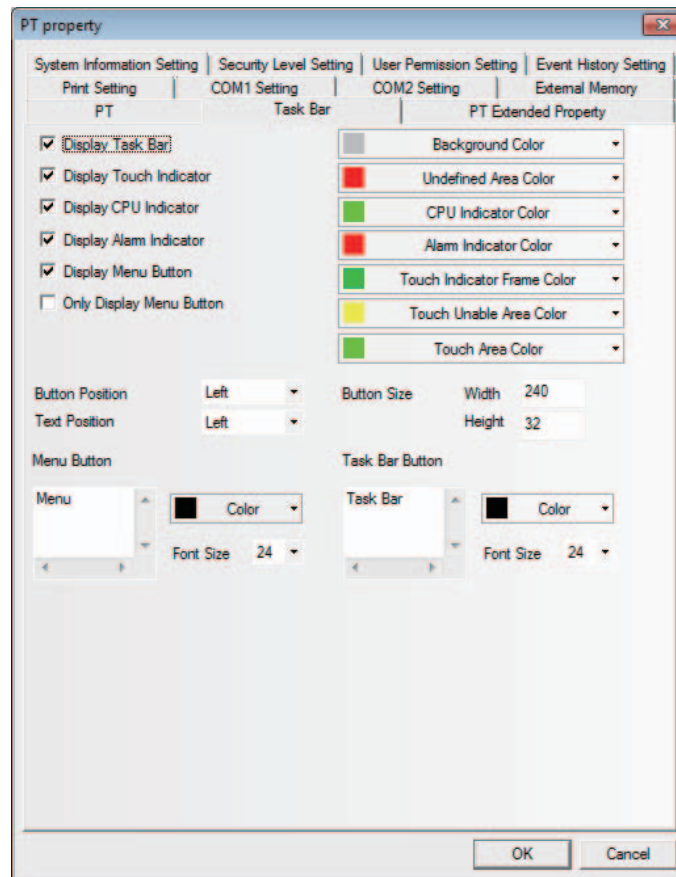

**Display Task Bar:** Determines whether to display the task bar or not. If the “Display Task Bar” is selected, the task bar as shown above will be displayed at the bottom of the screen.

**Display Touch Indicator:** When the screen is touched, the touch indicator will change the color. If the “Display Touch Indicator” is checked, the touch indicator will be displayed at the right side of the task bar, as shown above. (The touch indicator is expressed by “T” in simulator and the PT.)

**Display CPU Indicator:** CPU Indicator is a Level Meter showing the usage condition of CPU in percentage form. If “Display CPU Indicator” is checked, CPU Indicator will be displayed at the right side of the task bar, as shown above. (The CPU Indicator is expressed by “P” in simulator and the PT.)

**Display Alarm Indicator:** Alarm Indicator is a Level Meter showing the ratio of the current alarm numbers to the total alarm numbers logged in the alarm information. If “Display Alarm Indicator” is checked, Alarm Indicator will be displayed at the right side of the task bar, as shown above. (The alarm indicating lamp is expressed by “A” in simulator and the PT.)

The Alarm Indicator is the bar to display the number in percentage which divides the total number of the alarm the registered to Alarm Settings with the number of the alarm currently occurring.

**Display Menu Button:** After this option is checked, you can use the Menu Screen. If this option isn't checked, the Menu Screen will not pop up.

**Only Show Menu Button:** After this option is checked, only the Menu Screen button is displayed in the task bar.



**Background Color:** Determines the background color of the task bar. You can select the following colors at “Default Colors” or select “Custom Colors” to configure any colors you want.

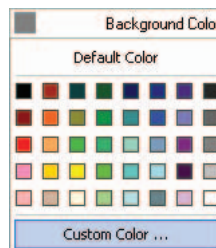

**Undefined Area Color:** When you click the undefined area, i.e. the area outside of working area for touchable components or without the components, the Touch Indicator will change colors.

**CPU Indicator Color:** Refers to the color of CPU Indicator.

**Alarm Indicator Color:** Refers to the color of Alarm Indicator.

**Touch Indicator Frame Color:** Refers to the box color of the Touch Indicator.

**Touch Unable Area Color:** Refers to the Touch Indicator color shown when the nonclient area is touched (including when expected effect is not realized after the component(s) being touched).

**Touch Area Color:** Refers to the Touch Indicator color shown when the client area is touched (including when related action(s) is (are) performed after corresponding component(s) or Menu Bar etc. being touched).

**Menu Button/Task Bar Button:** Input the texts which should be displayed in the Task Bar and in the location which displays the Menu Screen of the Task Bar.

**Button Position:** Refers to the positions of the Menu Button and Task Bar Button, i.e. “Left” and “Right”. If you select “Right”, the Menu Button and the Task Bar Button will be placed in the lower-right corner of the screen. On the contrary, they will be placed in the lower-left corner of the screen.

**Text Position:** The text alignment in the Menu Button and the Task Bar Button includes “Left”, “Right” and “Center”.

**Button Size:** Refers to the width and height of the area where the button locates.

**Font Size:** Refers to the font size of the texts in the Menu Button and the Task Bar Button.

## 3-10-3 PT Extended Properties

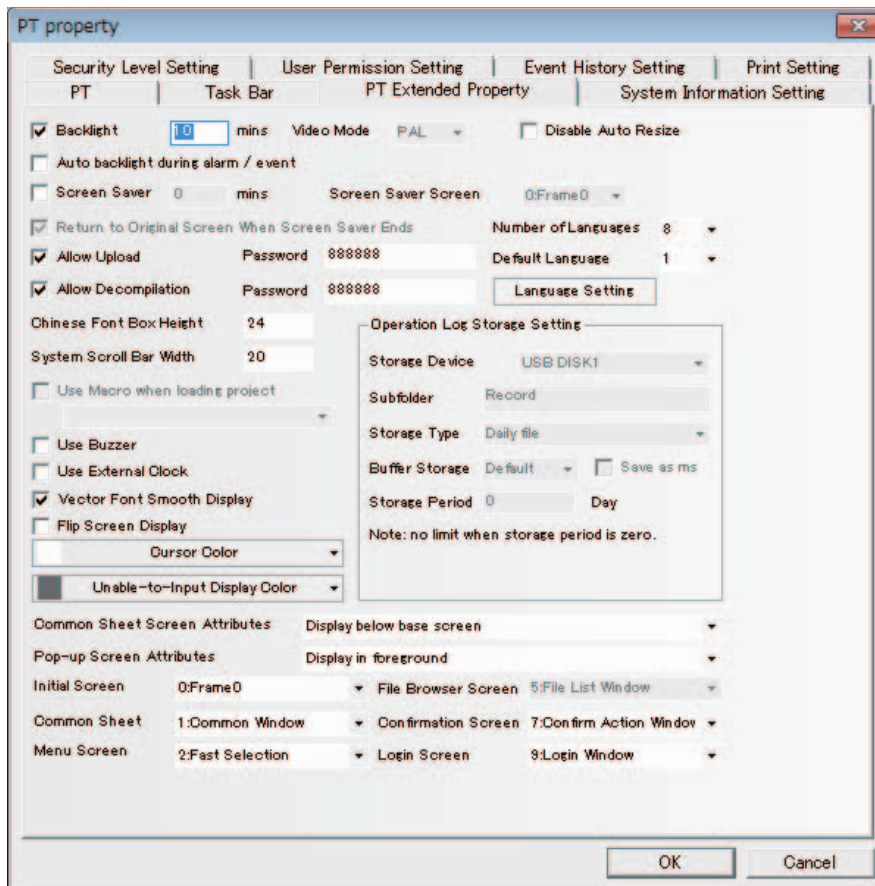

**Backlight:** How long (minute) the backlight will be closed when the screen is not touched.

**Auto backlight during alarm/event:** When it is checked, the backlight will automatically turn ON when the alarm/event occurs.

**Screen Saver:** The duration until the screen saver is started after the inactivity.

**Screen Saver Screen:** After the screen saver is checked, a certain screen can be selected as Screensaver Screen.

**Return to Original Screen when Screensavers Ends:** When it is checked, the screen will return to the Original Screen after the screensaver ends.

**Allow Upload:** Since the respects of the information disclosure, remove the check the check box when prohibiting the upload.

**Allow Decompilation:** Allows the user to decompile and modify the PKG files generated by configuration compilation after it is checked. For this function, a password setting is required.

**Number of Languages:** Specify the number of the languages used in the project. The languages used by the component of the PT is generally less than or equal to the maximum language number. For example, the maximum language number is 7 and the number of used languages is 5, the components in PT can only use 5 kinds of languages. For the details, refer to *3-8-1 Text Library (Page 3-238)* in *NB-Designer Operation*.

**Default Language:** Refers to the default language when the project is opened originally.

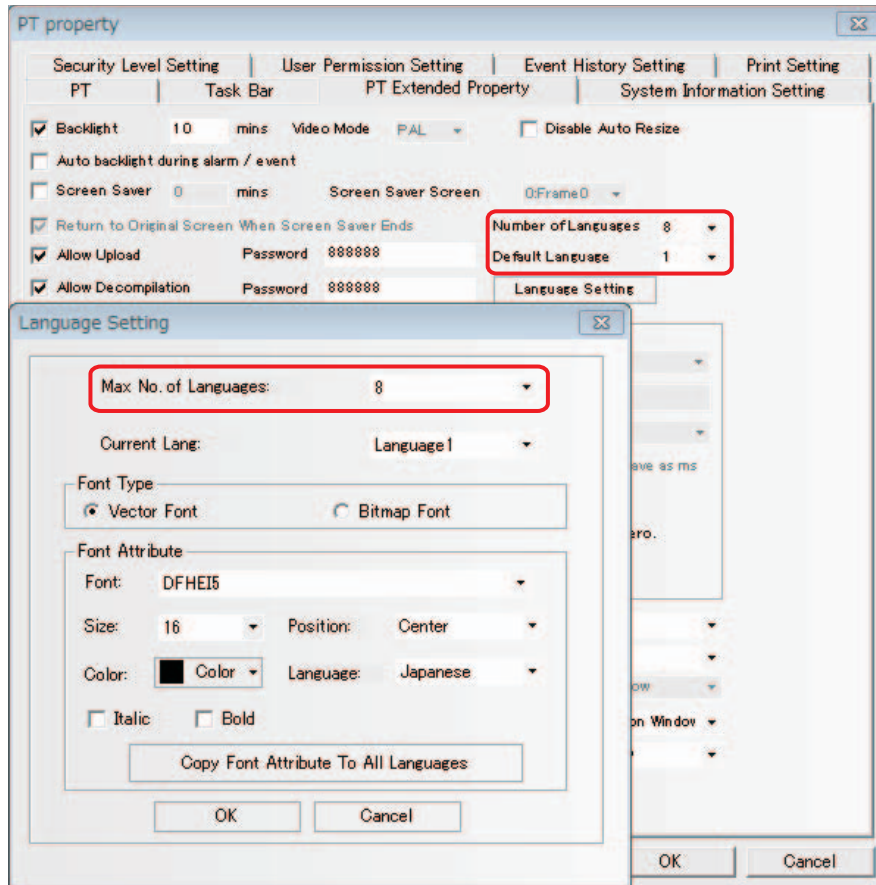

**Disable Auto Resize:** Temporarily disables the set Auto Resize function for all components in the project data.

**System Scroll Bar Width:** Refers to the component with the scroll bar such as operation log component. The width of the scroll bar can be set with this option and the width range is from 20 to 120 pixel point. When the spacing is 4 (i.e. 20, 24, 28 and so on), the scroll bar can be displayed effectively.

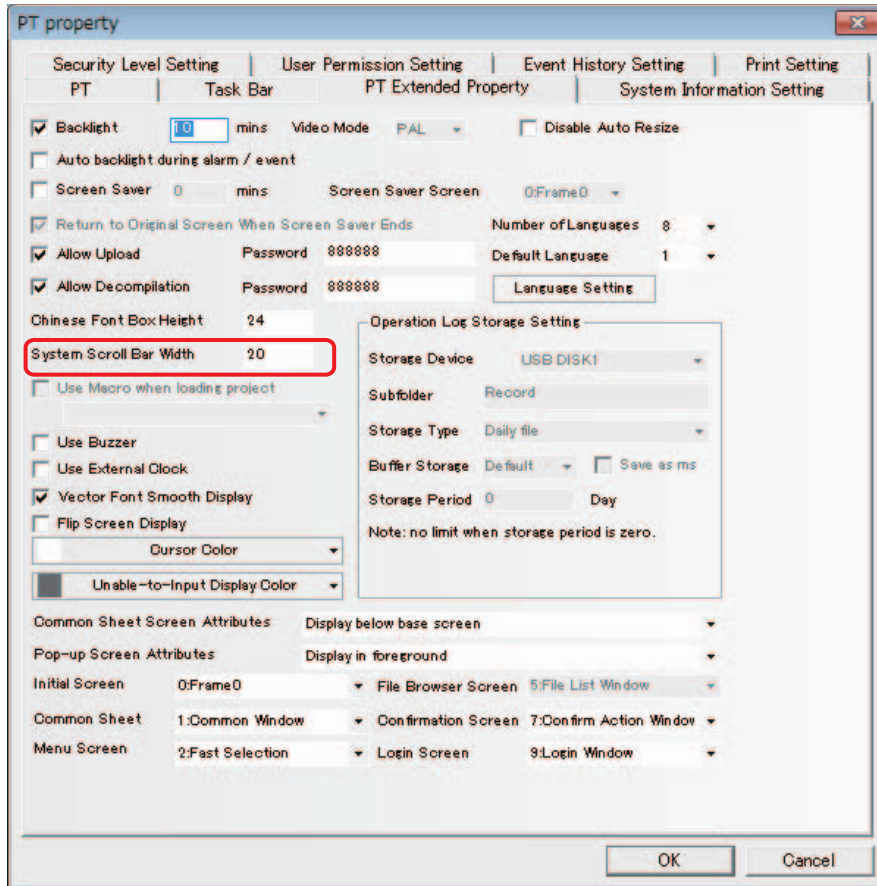

**Use Macro when loading project:** Refers to the Macro file run firstly when the unit starts processing the project file after it starts.

**Use Buzzer:** When the component of the PT is pressed or the “Beep Function” is set for the Alarm or the Event, check the check box.

**Chinese Font Box Height:** Sets the height of text input box and the default value is 24.

When inputting the characters in Pinyin form, the Chinese font box height can be adjusted between 24 and 99 (pixel).

Perform the offline test and the effect is as shown below:

When the Chinese font box height is 24:



When the Chinese font box height is 34:



**Use External Clock:** After it is checked, the values in the memory of LW9010 to LW9017 are adopted as the event occurrence time, and internal clock of the PT are not adopted.

**Note** Using this function needs to use Data Transmission component to transfer the data in the time memory of PLC to LW9010-LW9017 periodically.

LW9010: Second

LW9011: Minute

LW9012: hour

LW9013: Date

LW9014: Month

LW9015: Year

LW9016: Week (unavailable)

LW9017: Millisecond

In the following example, we will use the Data Transmission component to transfer the values in the time memory of PLC to LW9010~LW9017 periodically.

i.e. transfer SD100 to LW9015, SD101 to LW9014, SD102 to LW9013, SD103 to LW9012, SD104 to LW9011 and SD105 to LW9010.

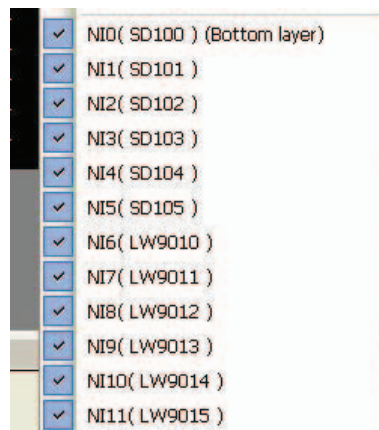

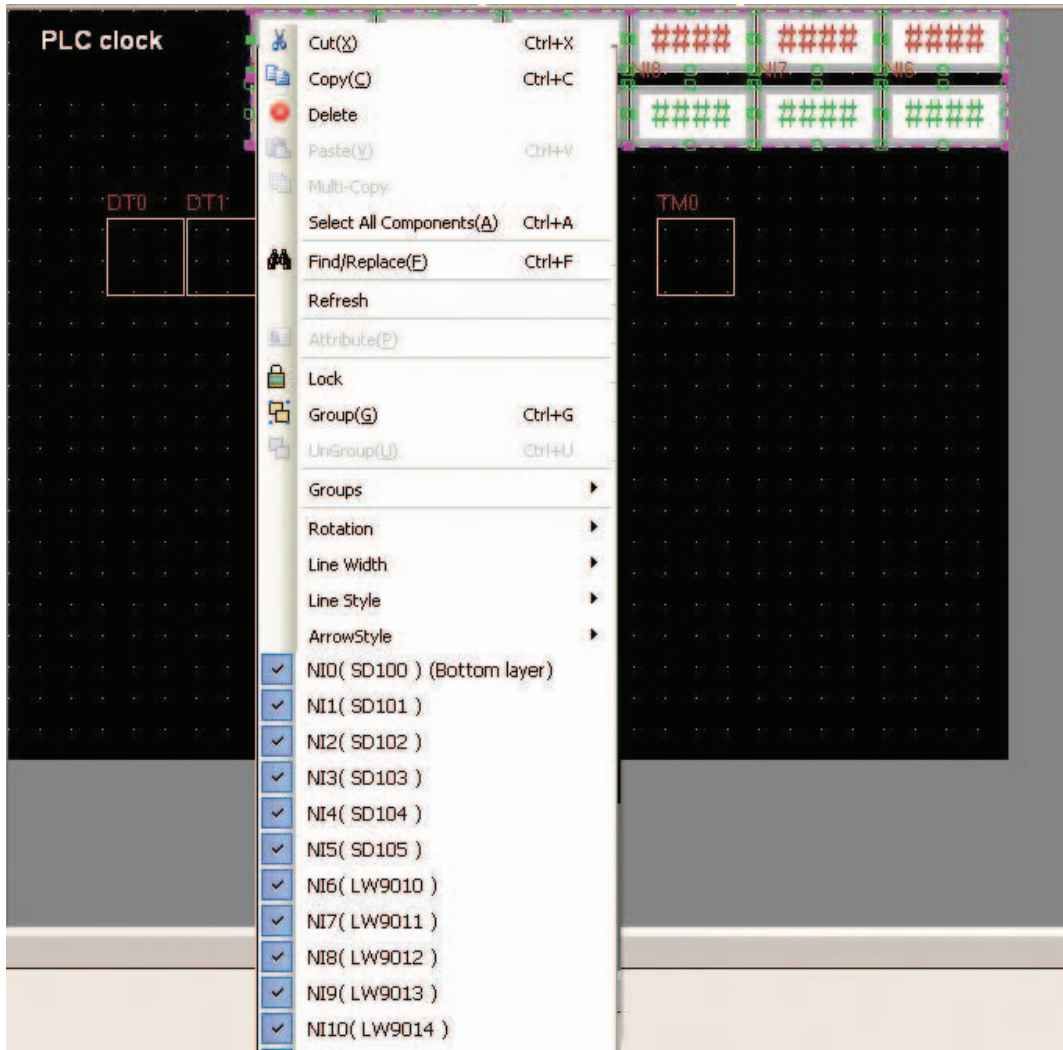

Because the order of the corresponding addresses is reversed, so it needs 6 Data Transmission components and 1 Timer component.

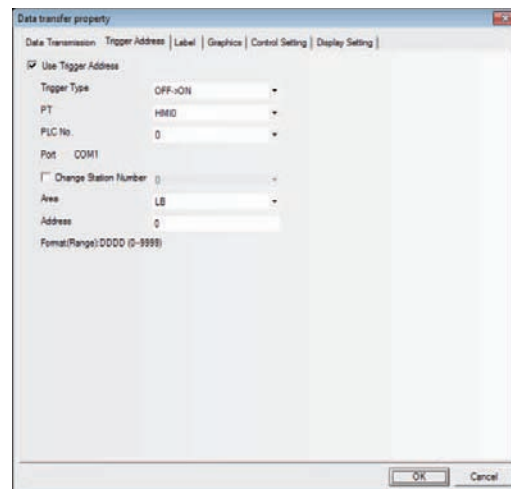
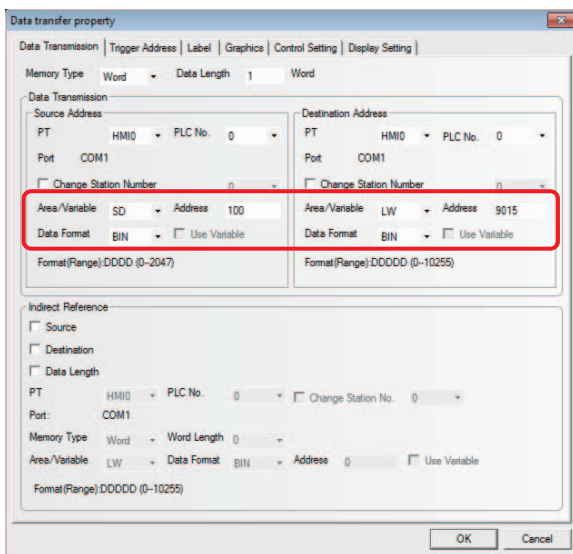



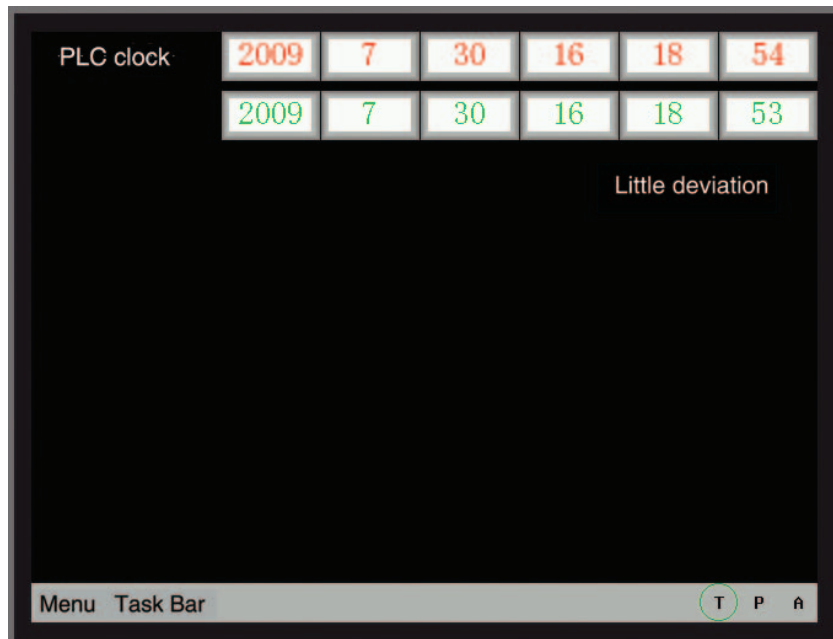
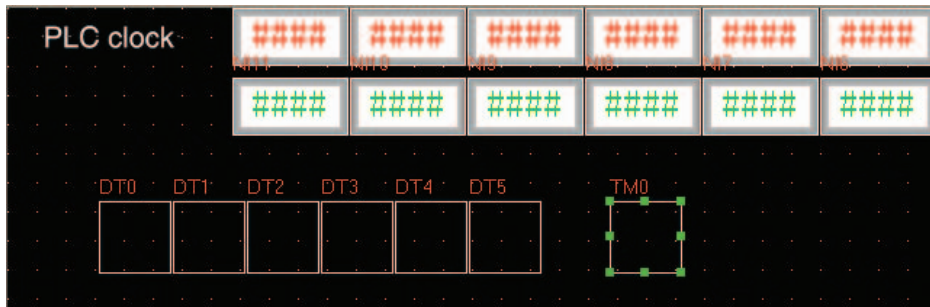
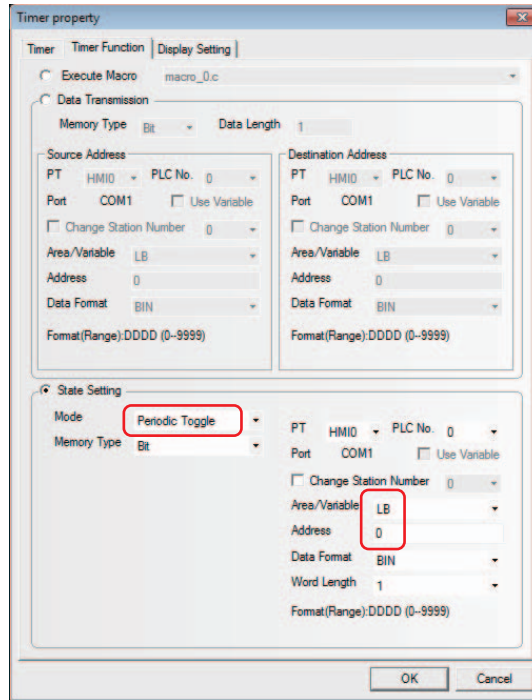

After creating a new Event Setting, place 1 Event component, then perform the indirect online test and the effect is as shown below:

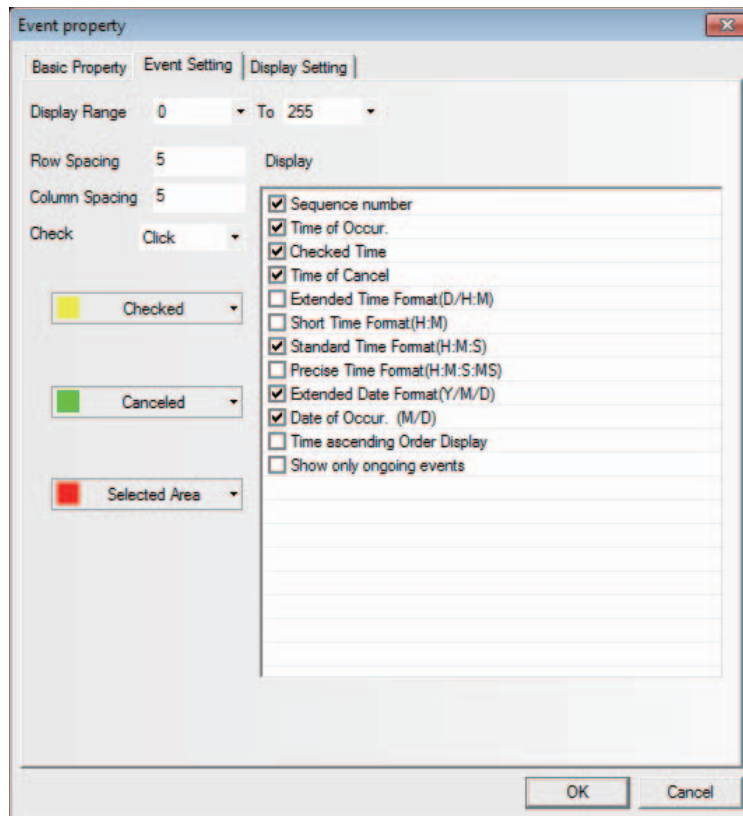
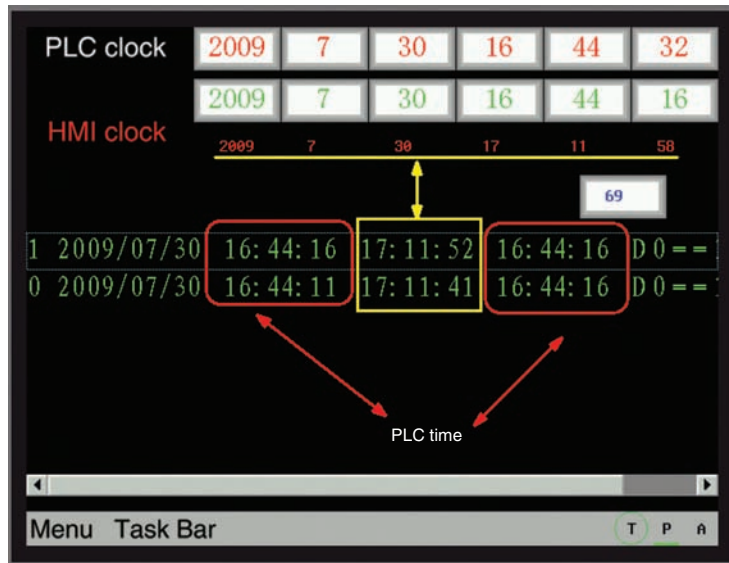

“Checked Time” refers to the PT time, therefore we must pay attention to it when using this function. And it'd better to use it after the time is adjusted well.

**Vector Font Smooth Display:**

The characters can be made smooth, beautiful and no-alias by using “Vector Font Smooth Display”. But using this function can increase the computations of the PT, and may affect the processing speed of the PT with the slower speed of refreshing of the PT. Therefore, if the user doesn’t have the higher requirements for the vector font display but have the requirements for the faster refreshing speed of the PT, please do not check this option. The default is checking “Vector Font Smooth Display”.

This function doesn’t support Event Setting, Event, Alarm, Alarm List, List, Drop-down List, Data History components and Operation Log component.

The comparison effect of checking and not checking the [Vector Font Smooth Display] is shown as below:

The effect of checking [Vector Font Smooth Display]: The effect of not checking [Vector Font Smooth Display]:



It is obvious that the edges after being handled are more smooth and no-alias.

**Flip Screen Display:**

The optimal visual angle for the screen of the PT is front view. If the screen needs to be seen by the overlooking method, i.e. from top to bottom, in some special occasions, the display effect will become poor; and the “Flip Screen Display” is added to turn the screen reversely to obtain the same display effect as viewed from the front.

There are 2 methods for Flip Screen Display:

Method 1: Enter [PT Extended Properties] tab in PT Property, check [Flip Screen Display], and the display is reversed after it is downloaded to the screen. And the screen will keep as Flipped Display after the power failure or restart of the screen.

Perform the offline test and the effect is as shown below:

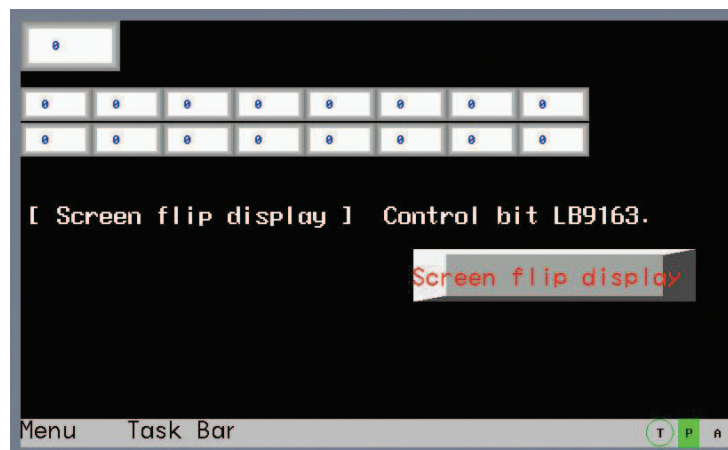

Method 2: The flipping of the screen is controlled by the local special memory LB9163 (LB9163 is read/write type.). When LB9163 is turned ON, the screen is displayed vertically-flipped. When the flipped screen display function is controlled by LB9163, the flipping function can’t be maintained after the power failure or restart of the screen.

**Example:** Place a Bit Switch with the address of LB9163 and Property of “Alternate” in the screen.

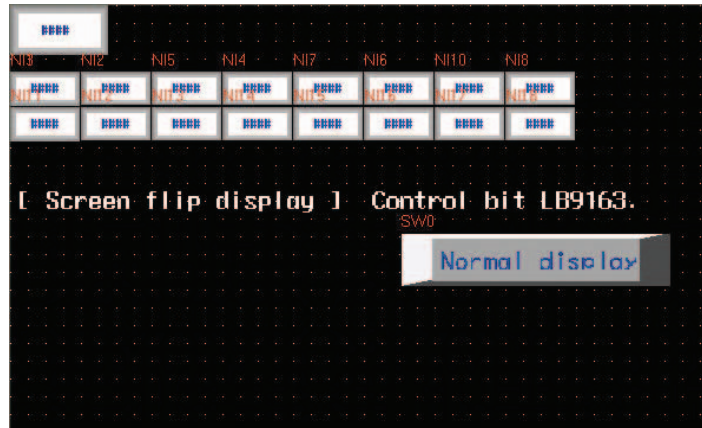

When LB9163 is ON, the display is flipped; while LB9163 is OFF, the screen is displayed in the normal direction. Perform the offline test and the effect is as shown below:

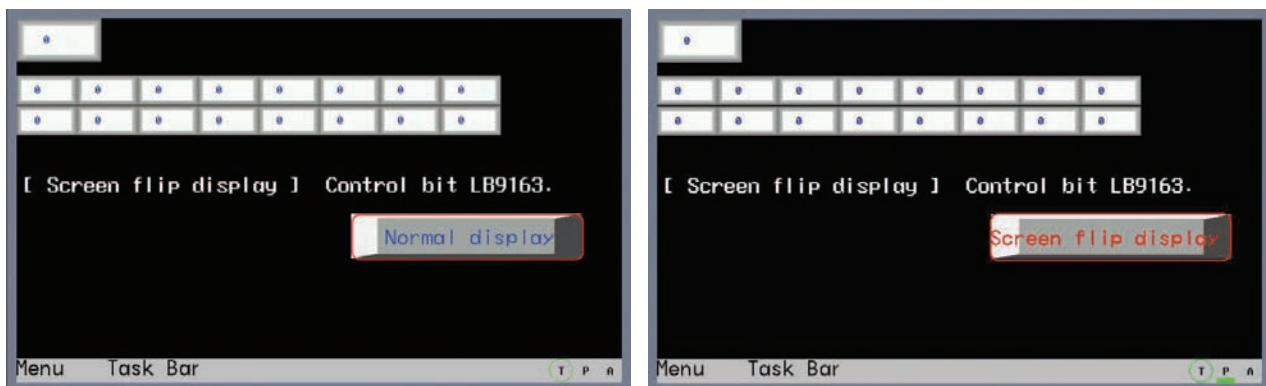

**Common Sheet Screen Attributes:** Determines the Common Sheet for the project program to be displayed above or below the Base Screen.

**Pop-up Screen Attributes:** Specify the pop-up screen whether if it is displayed on top of the screens or not.

**Initial Screen:** The screen is displayed at first by the PT after the unit is started in user project mode. The default is Frame 0.

**Common Sheet:** Refers to the No. of Common Sheet of the project. The default is Frame 1.

**Menu Screen:** Refers to the No. of Menu Screen of the project. The default is Frame 2.

**File Browser Screen:** Refers to the No. of Browser File Screen of the project. The default is Frame 5.

**Confirmation Screen:** Refers to the No. of Confirmation Screen of the project. The default is Frame 7.

**Login Screen:** Refer to the No. of Login Screen of the project. The default is Frame 9.

**Unable-to-Input Display Color:**

The role of invalid component marks: When the enable condition isn't met or is invalid, using this option can set invalid component mark to indicate this component can't be used currently and the touch is not effective. Only the control components such as switch and Command Button component etc. can use invalid component marks, and the display components such as Lamp and Word Lamp component etc. don't support the invalid component marks.

**Example:** When the value of LW0 is 0, only M0 (Bit Switch) can be operated. When the value of LW0 isn't 0, M0 (Bit Switch) cannot be operated, and the invalid mark  will be displayed in the color which was specified.

- (1) Setting of Unable-to-Input Display Color: Double-click PT Property and enter [PT Extended Property] tab to select "red" as the Unable-to-Input Display Color.
- (2) Place one Bit Switch, i.e. M0, and set the enable conditions in the [Control Setting] tab for it, and then select [Conditional Enabling], [Word] LW0=0 and select [Show Unable-to-Input].

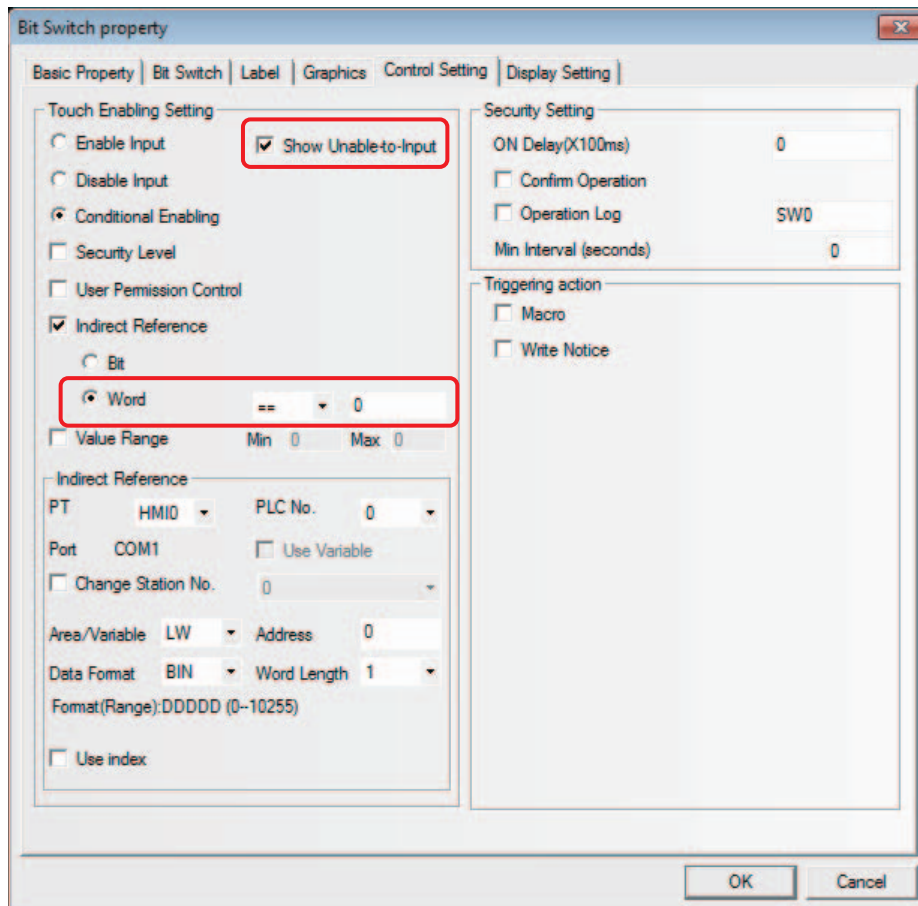

- (3) Place one Number Input component LW0.
- (4) Perform the offline test. And when LW0=0, M0 can be operated; and when LW0=50, M0 can't be operated and the invalid mark will be displayed. The effect is shown as below.

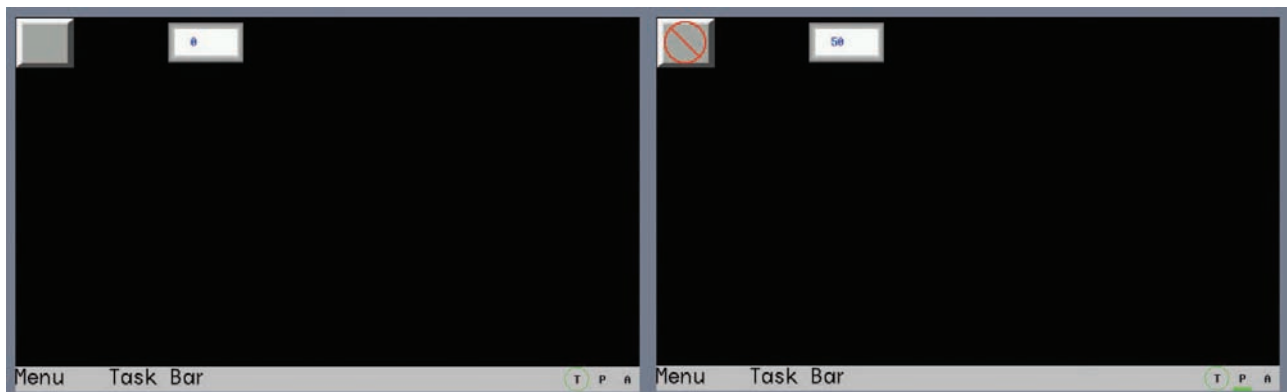

**Cursor Color:** Sets the cursor color for the component with the cursor such as Number Input component and Text Input component etc.

### 3-10-4 System Information Setting

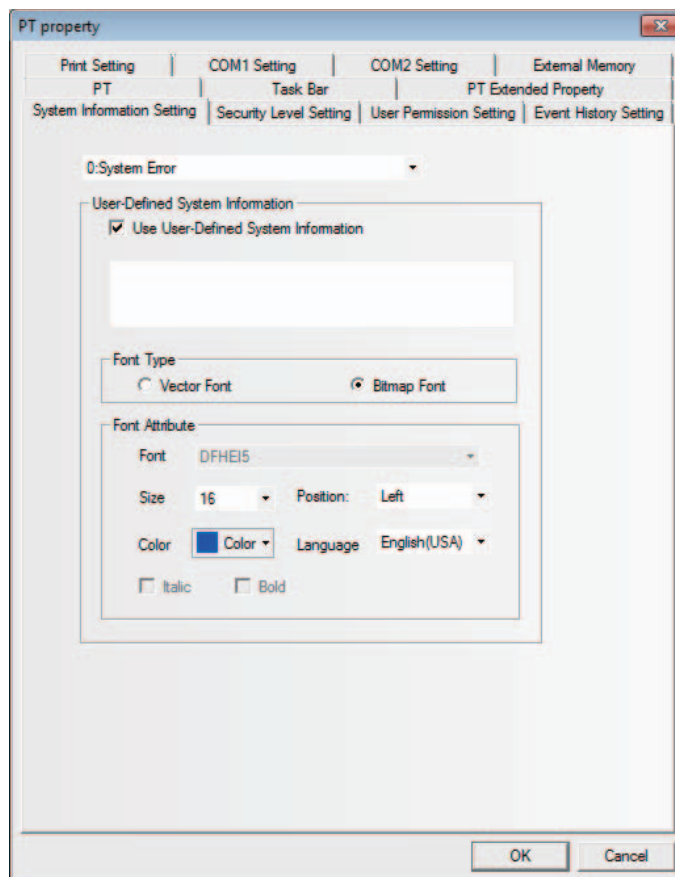

The message in default can be changed to the required text.

Enter the [System Information Setting] tab in PT Property, select the [Use User-Defined System Information] option to enter the corresponding text to the item of selected system information in the text box. This text supports Vector Font and Bitmap Font, as shown above.

**Example:** Change “PLC No Response” to “No Response”.

- (1) Enter the [System Information Setting] tab in PT Property.
- (2) Select “2: PLC No Response” in the drop-down box of the system information, and check the [Use User-Defined System Information] option and input “No Response” in the text input box.
- (3) Use the Vector Font with the following settings, i.e. AR PL UMinG CN, the size of 16, red and Bold.

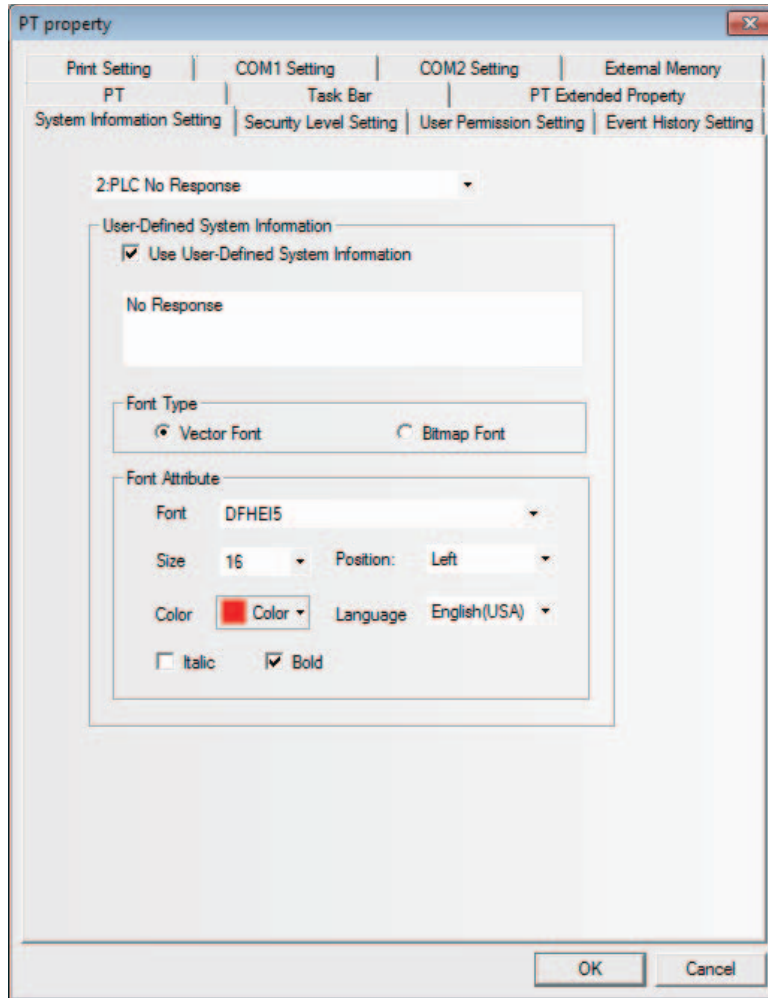

When the PT can't perform communications with PLC, "No Response" will be displayed.

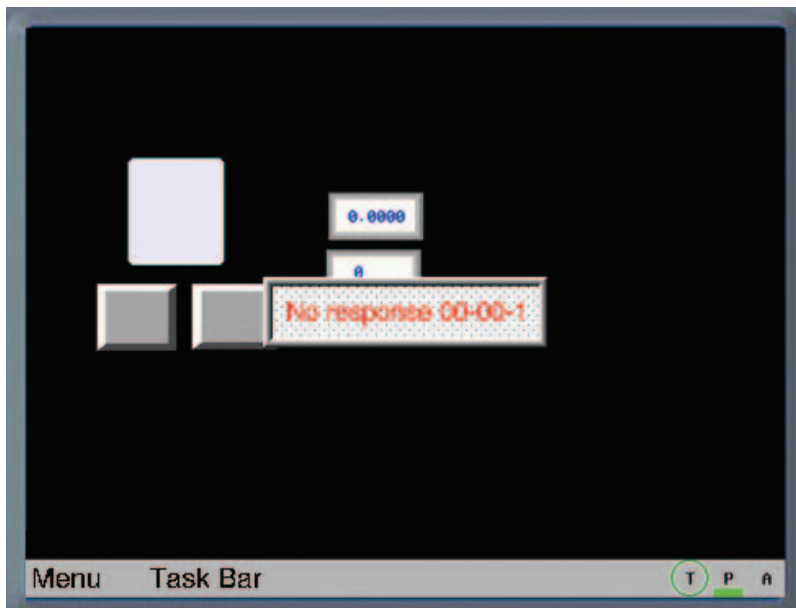

### 3-10-5 Security Levels Setting

The security level is classified into 16 levels (0 to 15) in the NB-Designer. One 8-digit number password can be set for each level at the request of the users, and the greater the level number, the higher the level. 15-level is the highest and 0-level is the lowest. When the security level is 0, it means no password. 0 can't be used for setting the password.

Number of Security Levels is 3 by default in PT Property, and it can be opened to 16 levels in the Security Levels Setting tab.

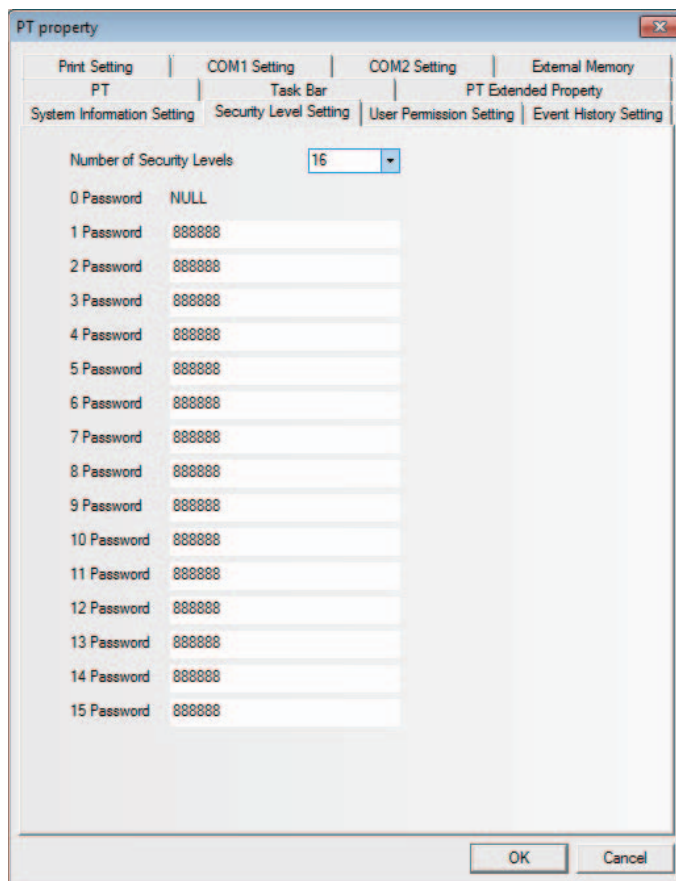

After the security level password is set, the user can use each group of specified passwords to perform screen and component managements. For example, after the screen security level is set to “2”, the screen can be switched to by inputting the user password; otherwise this screen can't be entered during the operation.

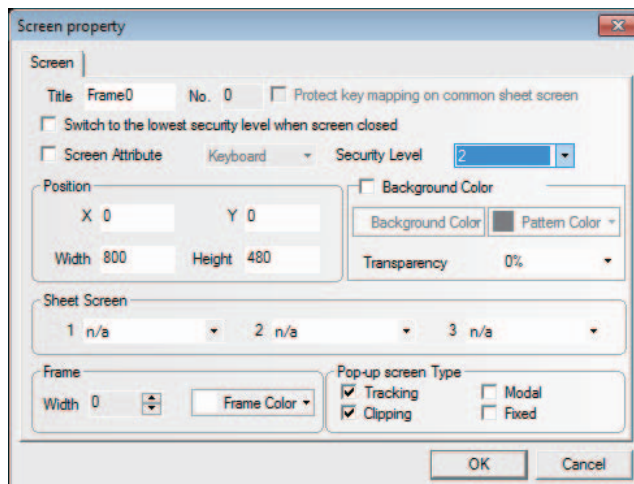



**Example:** Set 16-level security passwords for the project.

- (1) Set “Number of Security Levels” in PT Property to 16 accompanying the passwords for each level of security level 1 to 15.

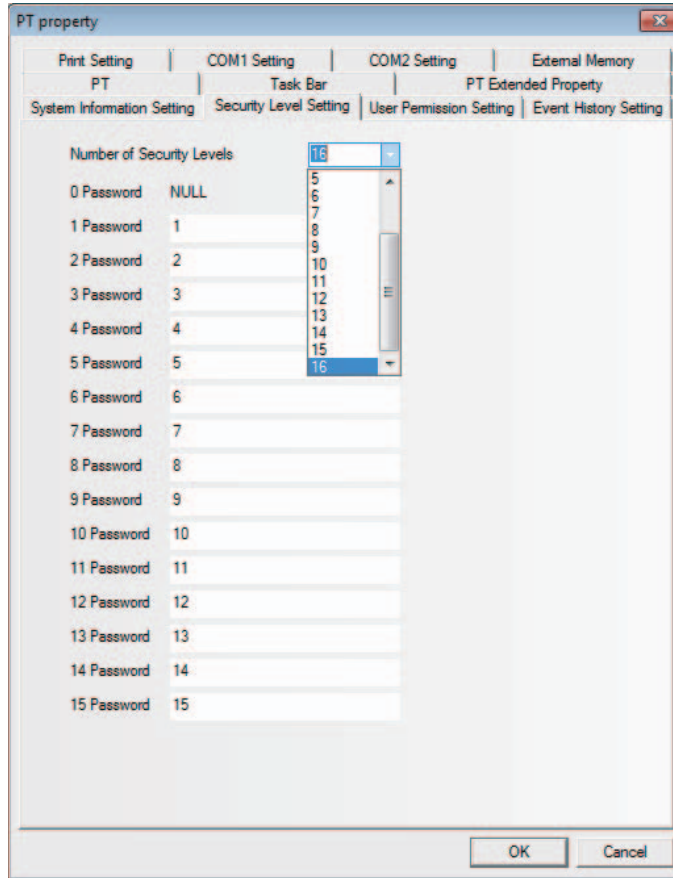

- (2) Use a double-word Number Input component with address of LW9040 as Frame 0 for inputting the password. LW9042 is used to display the security level and LW9043 is used to switch the security level forcefully. The 15 Function Keys are used to switch Frame 8 to Frame 22 respectively.

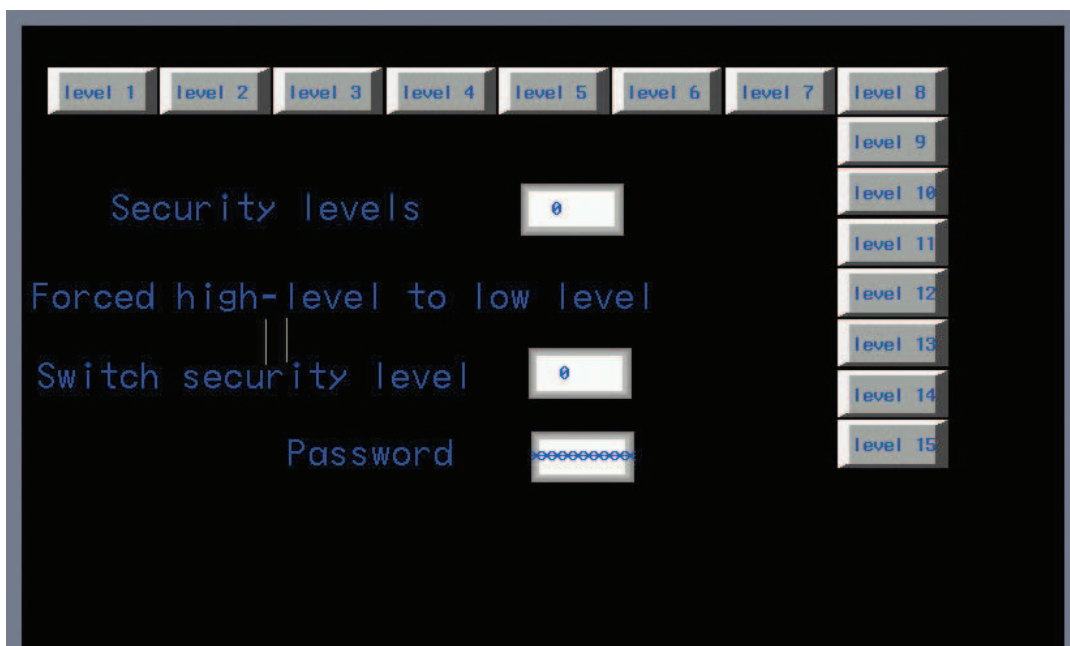

Set the screen security levels and make Frame 10 correspond to Security Level 1, Frame 11 correspond to Security Level 2, ..., and Frame 24 correspond to Security Level 15.

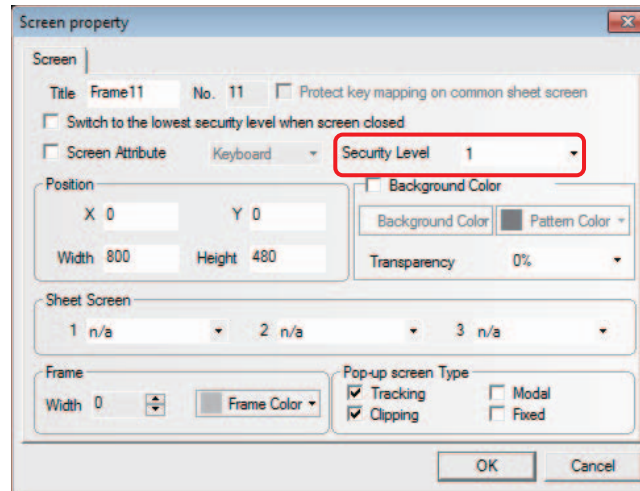

(3) Perform the offline test or download it to the screen to check the password level function.

### 3-10-6 User Permission Setting

The software opens 32 users and 32 operation permissions for free use. The users and operation permission can be set separately, and the operation permission is not limited to the users. And the online user addition/deletion and permission modification can be done in the PT.

#### 1 User Permission Setting

Check the [Enabled] option and input the contents to the User Name, Password, Logoff Time and Authorization.

**User Name:** Refers to the login name and the defaults are usr0 to usr31. The user name supports any characters.

**Password:** Refers to the login password, and the default is 888888. The password only supports the number instead of the other characters. The password ranges from 1 to 4294967295. And 0 can't be used for setting password.

**Logout Time:** Refers to the valid time for this user permission and the default is 10 minutes. After 10 minutes, this user permission will be automatically cancelled, and the operation permission can be obtained by inputting the password again. The logoff time ranges from 0 to 4294967295 minutes. When the Logout Time is specified to 0 minute, the user permission is always valid.

For example:

- (1) For the User Permission Setting of User 0: Check the [Enabled] option and set the User Name to Administrator, Password to 666666 and Logout Time to 1 minute. Assign 4 Authorities, i.e. Operation Permission, Process Permission, System Config Permission and Add/Delete User Permission respectively for the “Administrator (User 0)”.

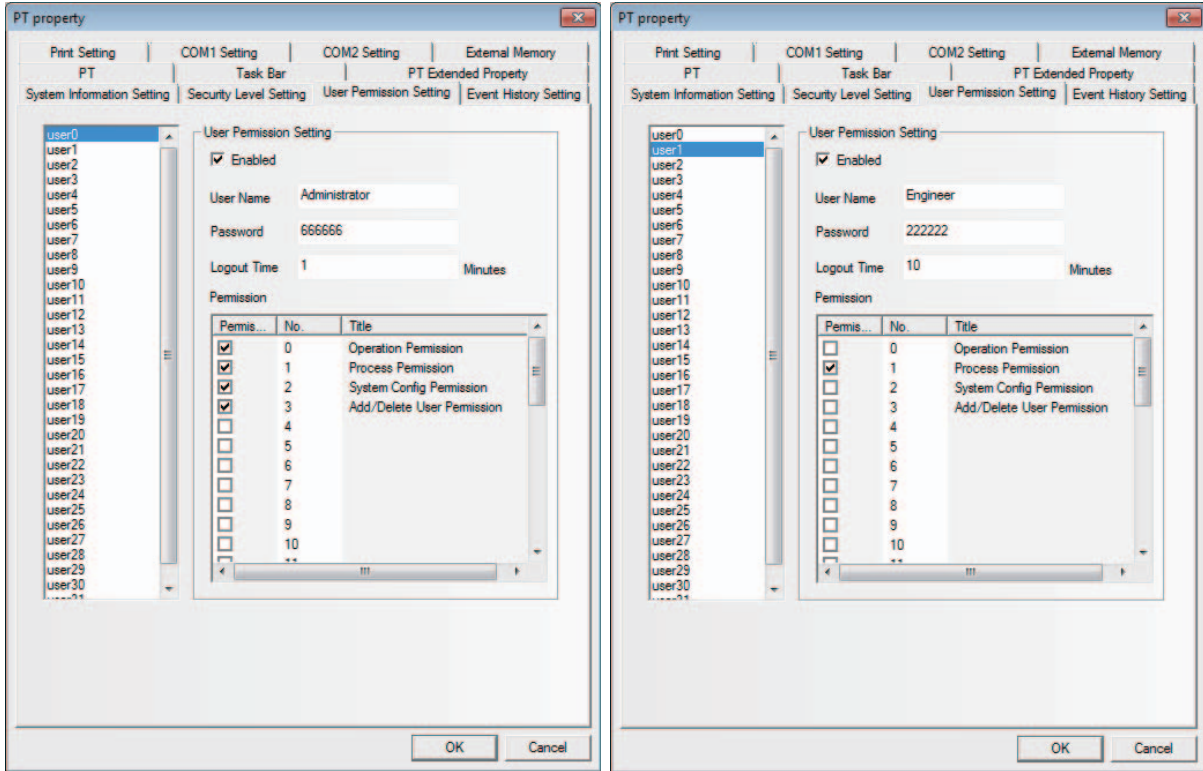

- (2) For User Permission Setting of User 1: Check the [Enabled] tab and set the User Name to Engineer, Password to 222222 and Logoff Time to 10 minutes. Assign 1 Authority, i.e. Process Permission to the “Engineer (User 1)”.

Besides the User Permission Setting in PT Property, using the following internal memory allows the operations concerning the user permission.

Addresses	Functions	Descriptions
LW9486~LW9501	Input the login user name.	32 characters max.
LW9502~LW9503	Input the password corresponding to the login user.	Double-word
LW9504~LW9505	Display the current user authority.	Double-word, read-only component, the corresponding 32 authorities.
LB9165	Execute the user login.	After it is turned ON, the login operation is performed, and later it is turned OFF automatically.
LB9166	Execute the user logout.	After it is turned ON, the logout operation is performed, and later it is turned OFF automatically.

## 2 Dynamically Add/Delete User Permission during operations.

Perform adding or deleting the user permission during operations in the PT. The following internal memory is used for adding or deleting the user permission during operations.

Addresses	Functions	Descriptions
LW9486~LW9501	Input the login user name.	32 characters max.
LW9502~LW9503	Input the password corresponding to the login user.	Double-word
LW9506~LW9507	Assign the user authority.	Double-word, Read/Write component, 32 authority assignments. LW 9506 to LW 9507 corresponds to 32 authorities (No. 0 to 31) and LW.B corresponds to each bit in LW 9506 to LW 9507. For example: LW.B 9506.0 represents the authority of No. 0; and LW.B 9506.A represents the authority of No. 10.
LW9508~LW9509	Logout time	Double-word, Unit: minute
LW9510~LW9511	Add/Delete user confirmed password.	Double-word
LB9167	Add the user permission.	After it is turned ON, the operation is completed and later it is turned OFF automatically.
LB9168	Delete the user permission.	After it is turned ON, the operation is completed and later it is turned OFF automatically.
LB9169	Modify the password	After it is turned ON, the current user password will be modified, and later it is turned OFF automatically.

● **Setting Permission Control of Component:**

Select the [Conditional Enabling] option in the [Control Setting] tab of “Bit Button Component Property” and check [Use Permission Control], as shown below.

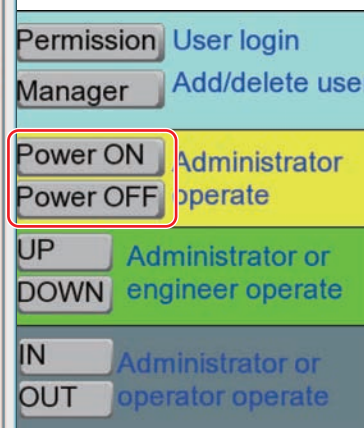
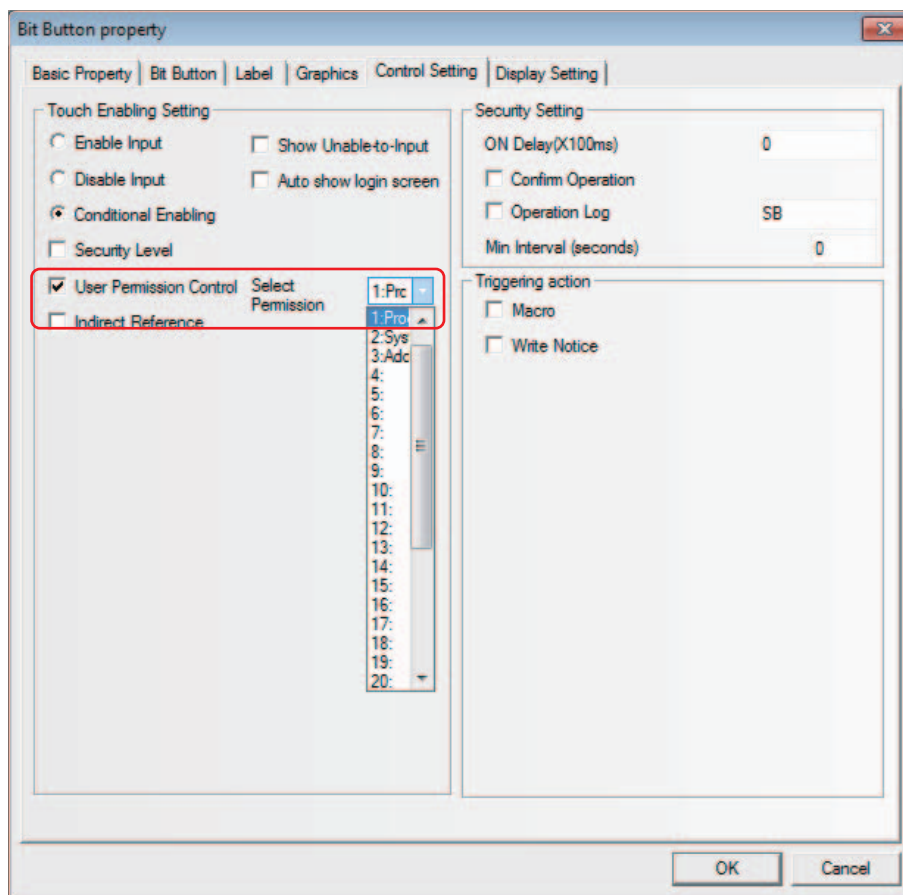

Setting “Use Permission Control” for the component means only the user having this operation authority can operate the component restricted by this authority.

● Login Screen for User Permission

Place one Bit Button component with the address LB0 and the [Set] format and pop-up the input screen of the user permission password specifying the Direct Screen.

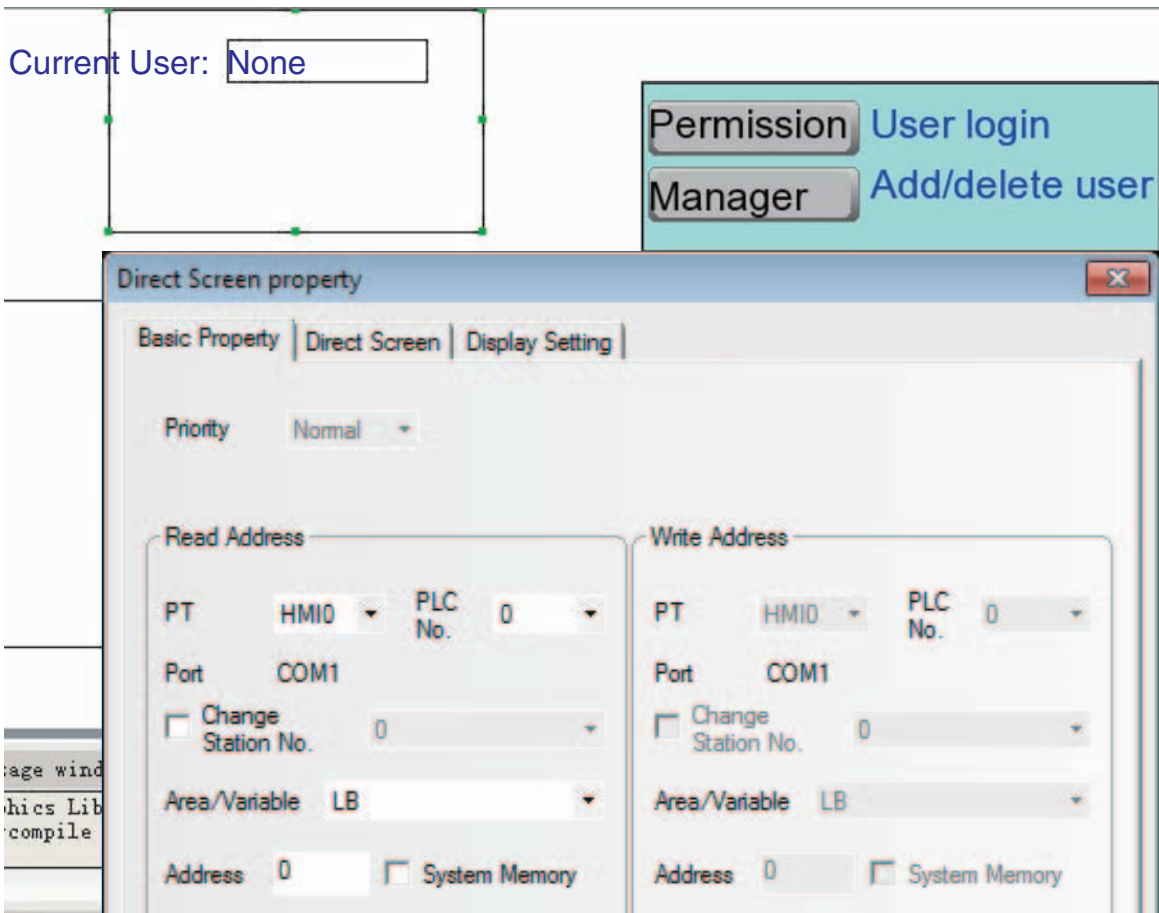
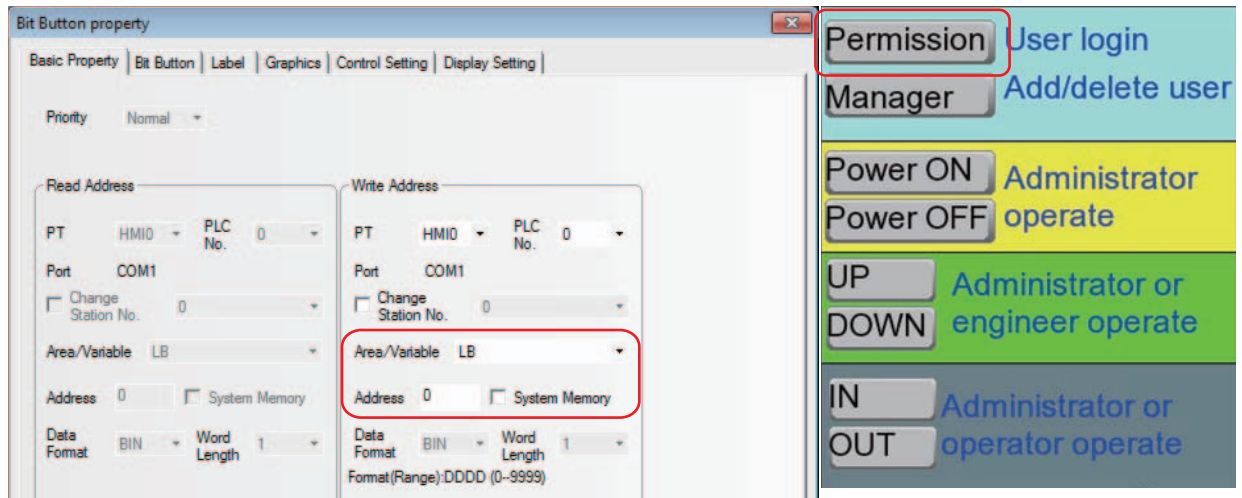

Create a new screen as the user permission password input screen:

Firstly, place one Text Input component for inputting the user name with the address of LW9486 and the maximum word length up to 16 (Here it is 10.).

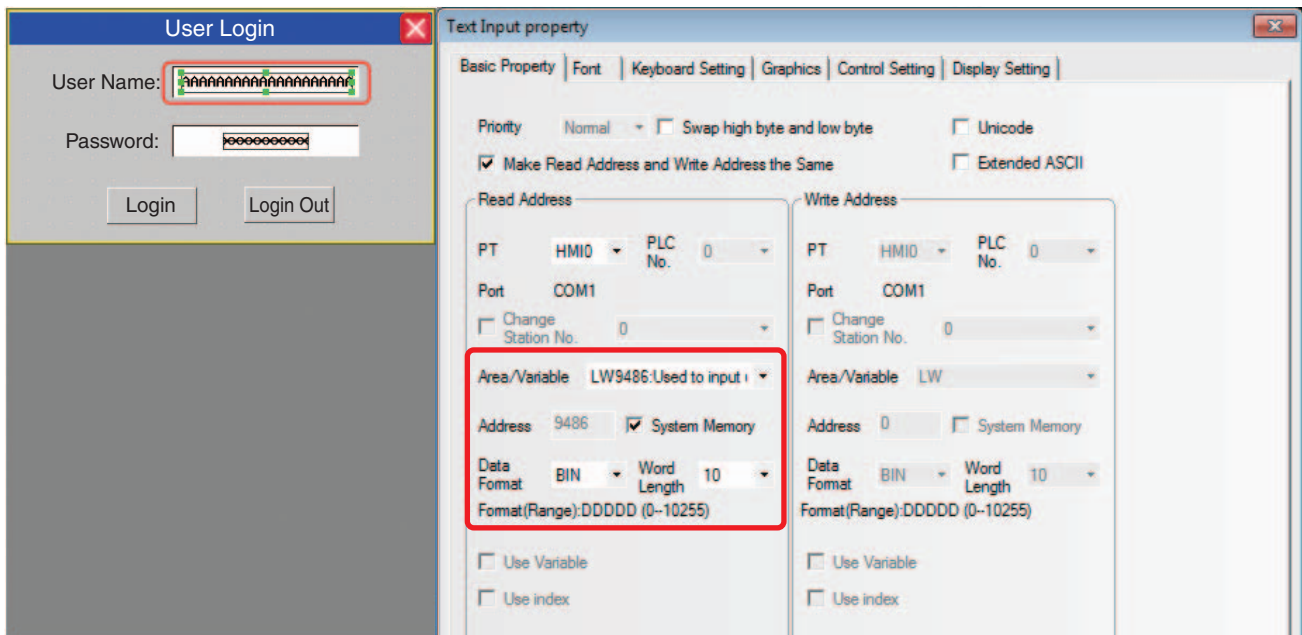

Secondly, place one Number Input component for inputting the password with the address of LW9502, the word length of 2 and the data type of [password].

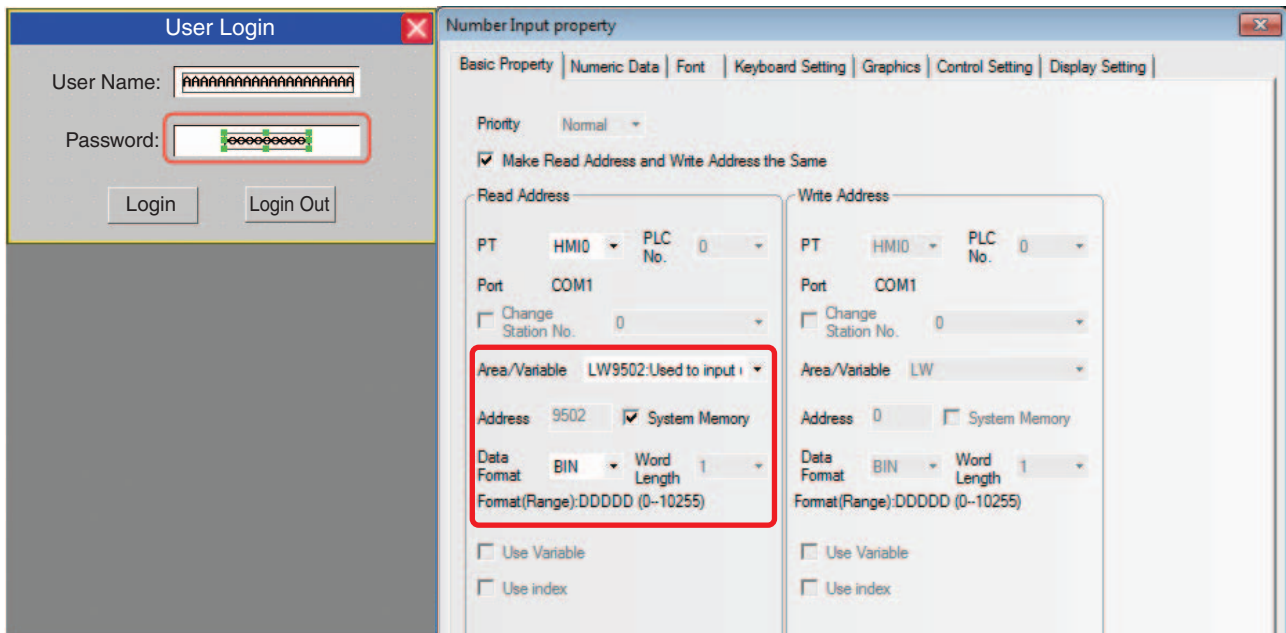

Thirdly, place one Bit Button component to perform “user login” with the address of LB9165, type of [Set] and the label content of “Login”.

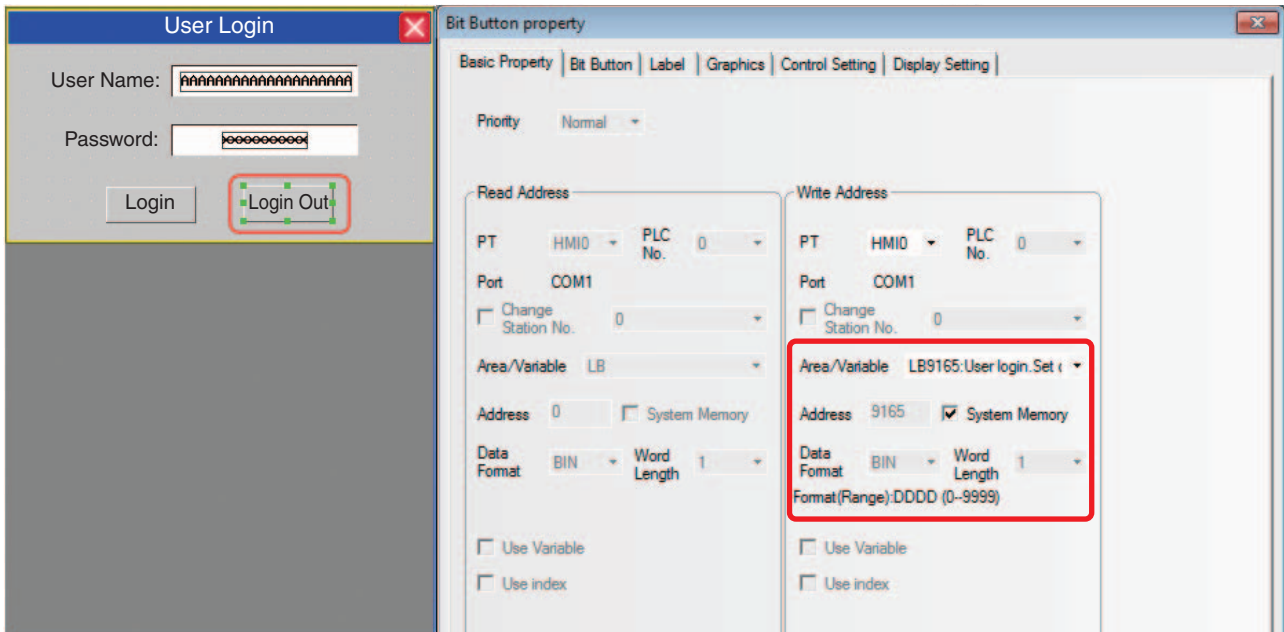

Finally, place one Bit Button component to perform “user logout” with the address of LB9166, type of [Set] and the label content of “Logout”.

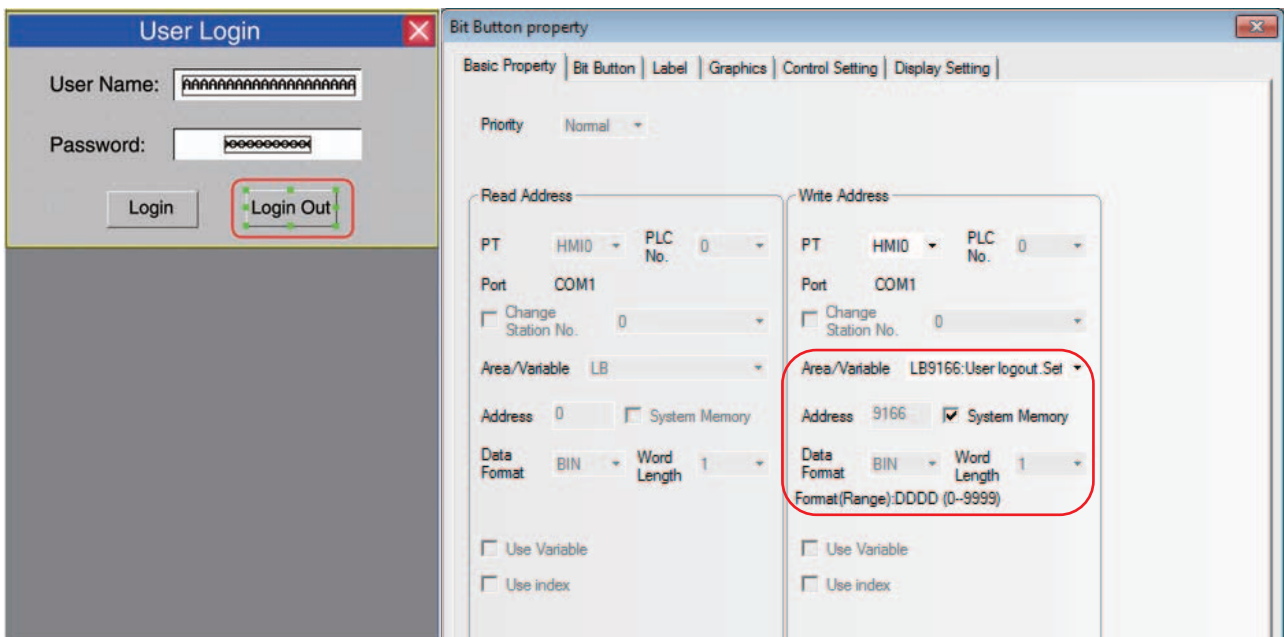

Perform the offline test and the effect is as shown below:

Input "Engineer" in [User Name] and "222222" in [Password] respectively, then click [Login].

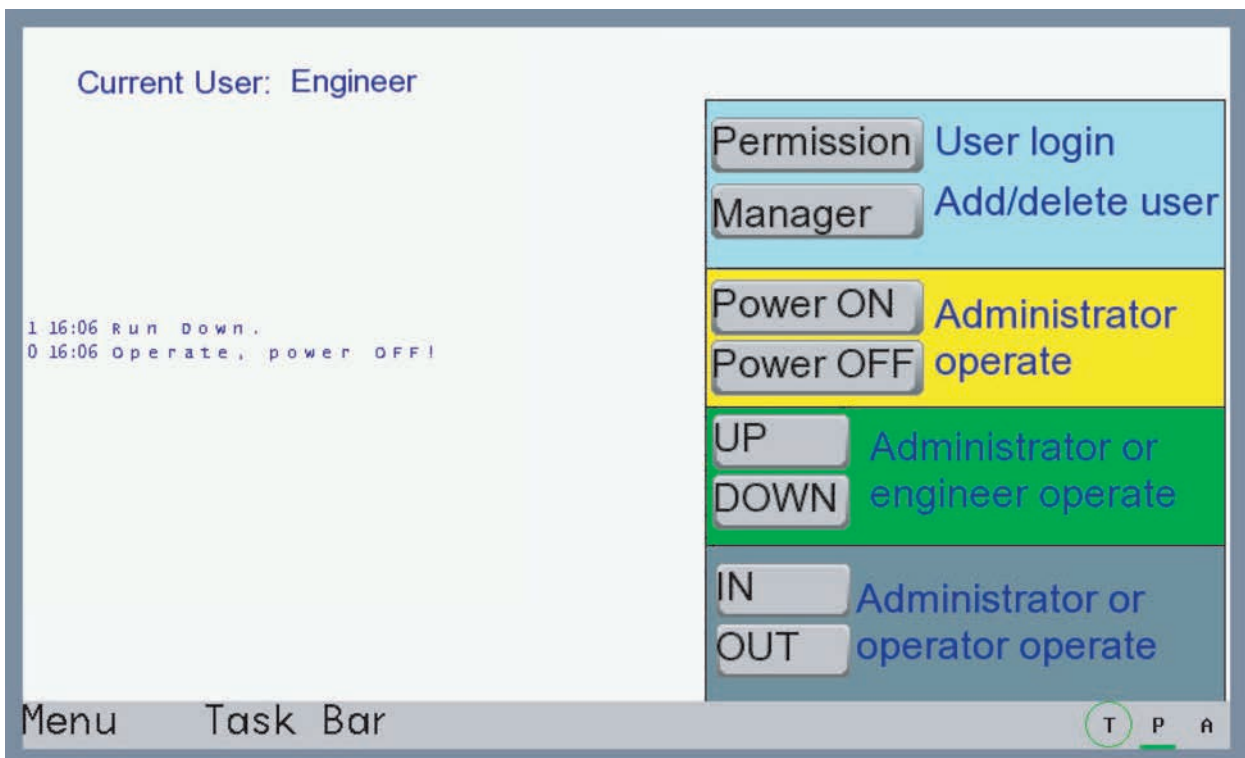
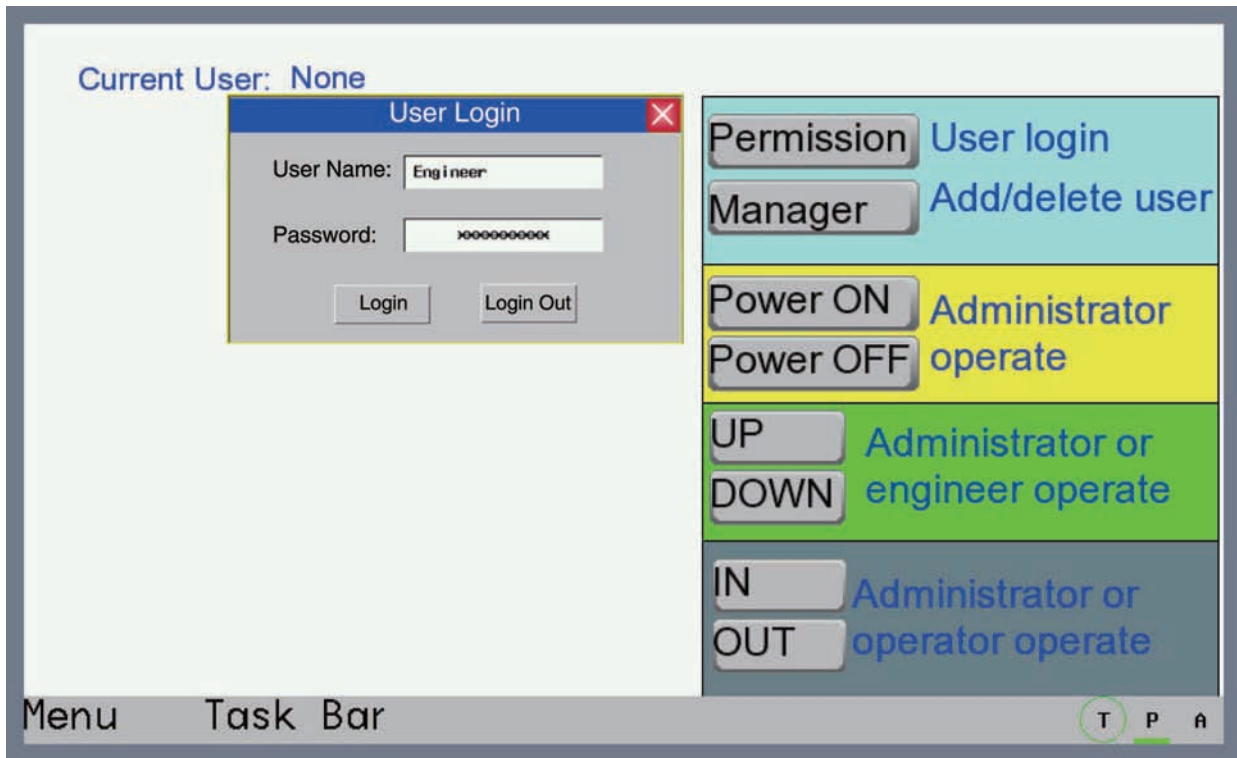



● **Add/Delete User Permission:**

Place one User Information component in Add/Delete User Screen to display the user information of the current system.

The “Table Property” in the “User Information Property” dialog can be edited according to the requirement.

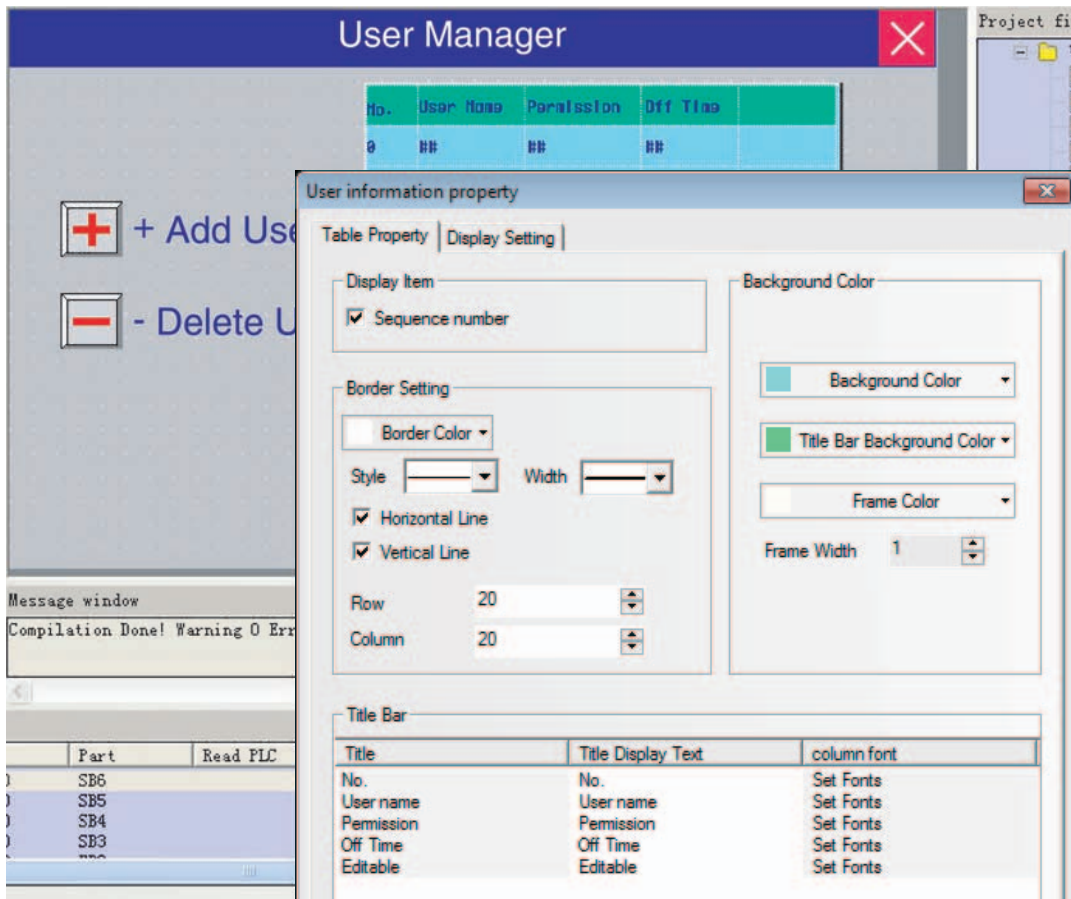

(a) Add User

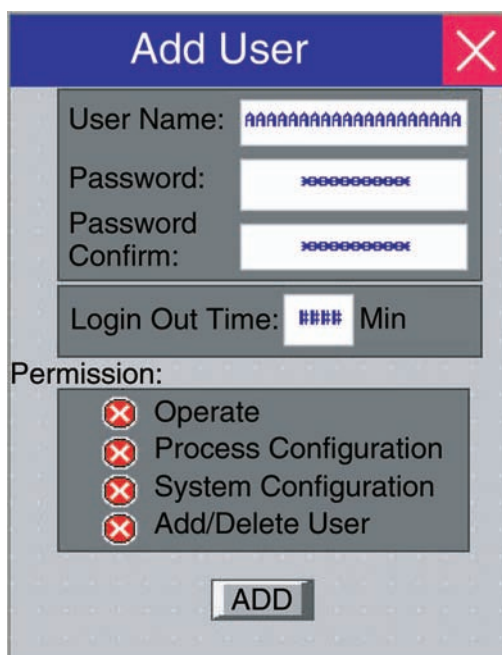

“Add User” screen contains User Name, Password, Password Confirm, Logout Time and Permission.

User Name: Place one Text Input component for inputting the user name with the address being LW9486 and the maximum word length up to 16 (Here it is 10.).

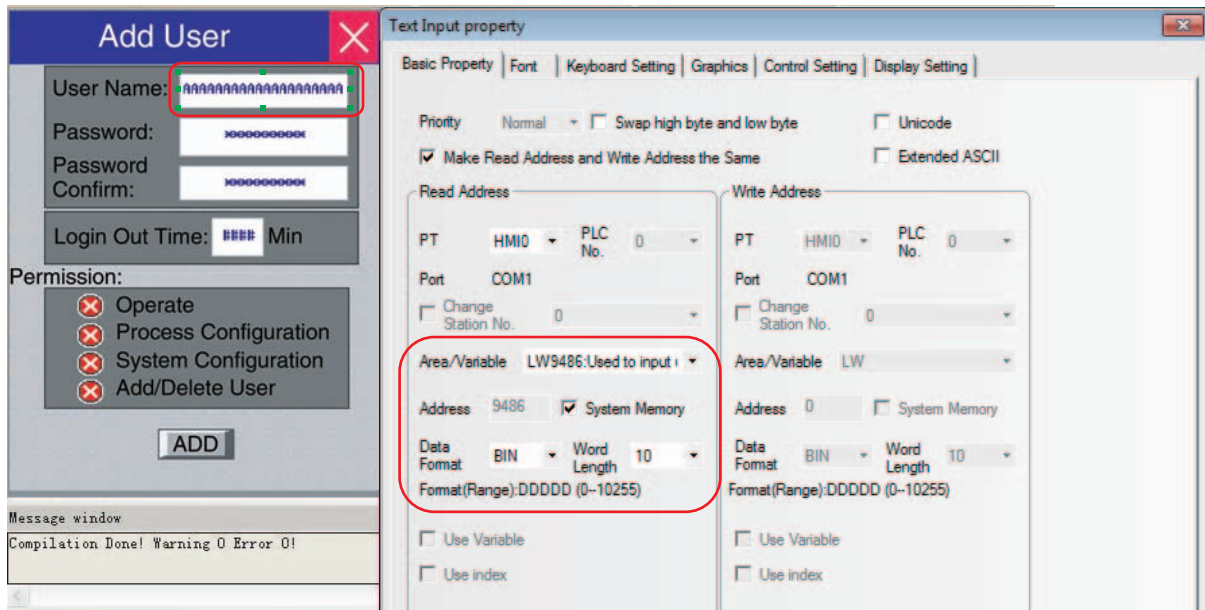

Password: Place one Number Input component with the address of LW9502, the word length of 2 and the data type of [password] here.

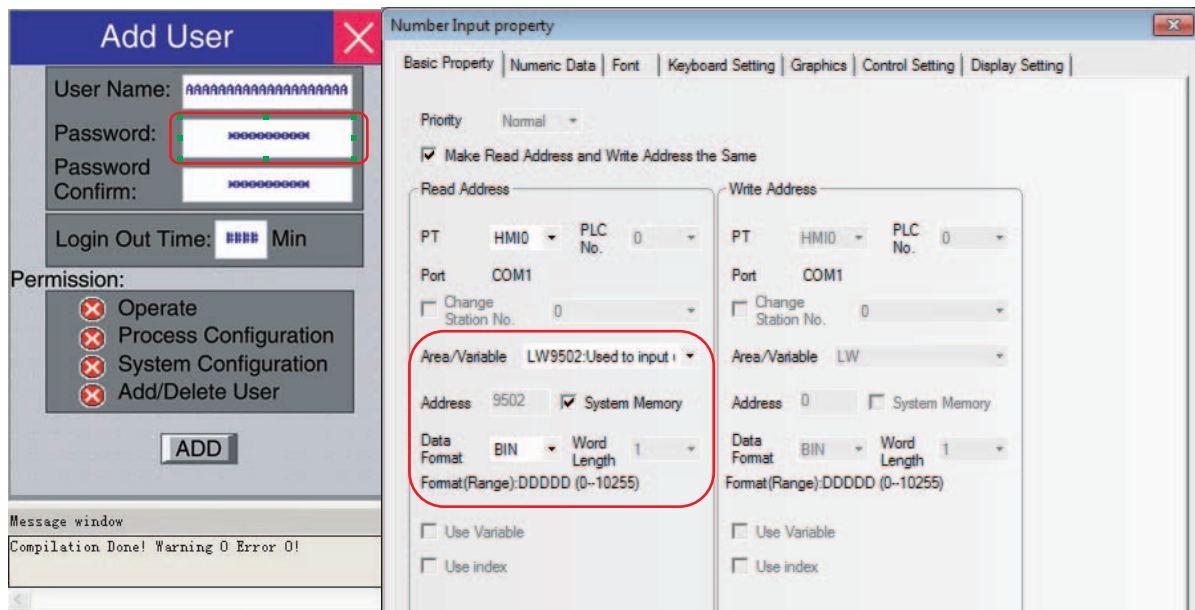

Password Confirm: Place one Number Input component by which the password is entered again for confirmation with the address of LW9510, the word length of 2 and the data type of [password] here.

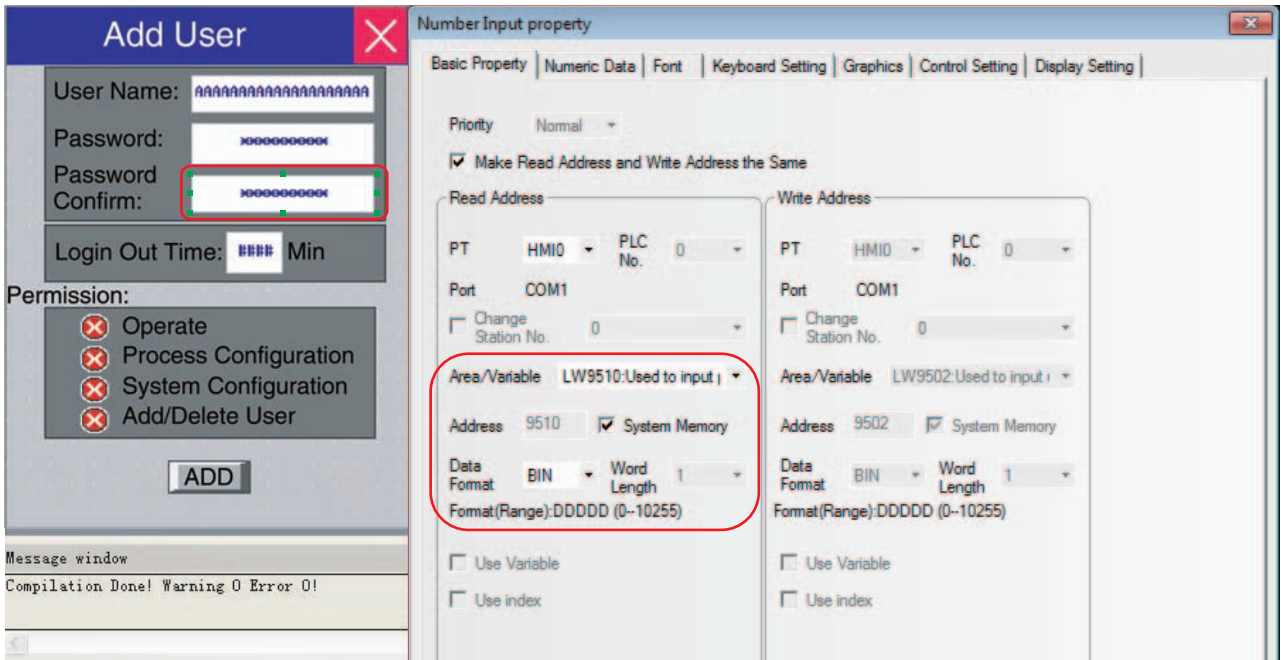

Logout Time: Place one Number Input component with the address of LW9508, the word length of 2 and the data type of [unsigned int] here.

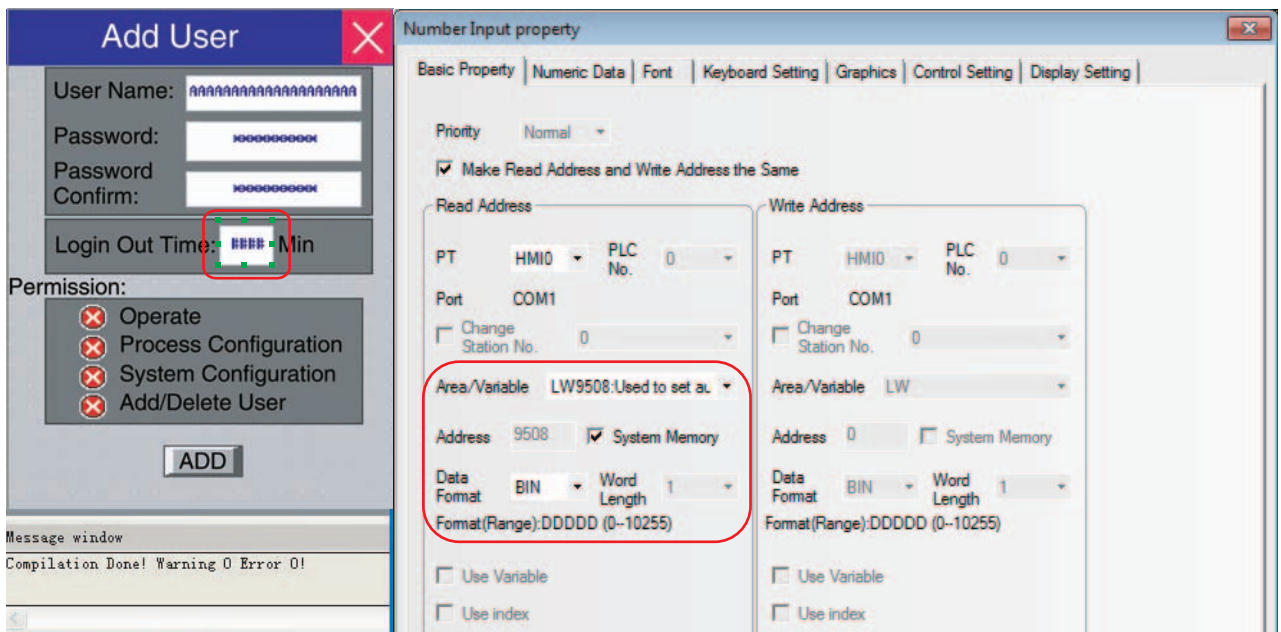

Permission: Place 4 Bit Switches with the addresses of LW.B 9506.0, LW.B 9506.1, LW.B 9506.2, LW.B 9506.3 respectively and switch type of [Alternate] here.

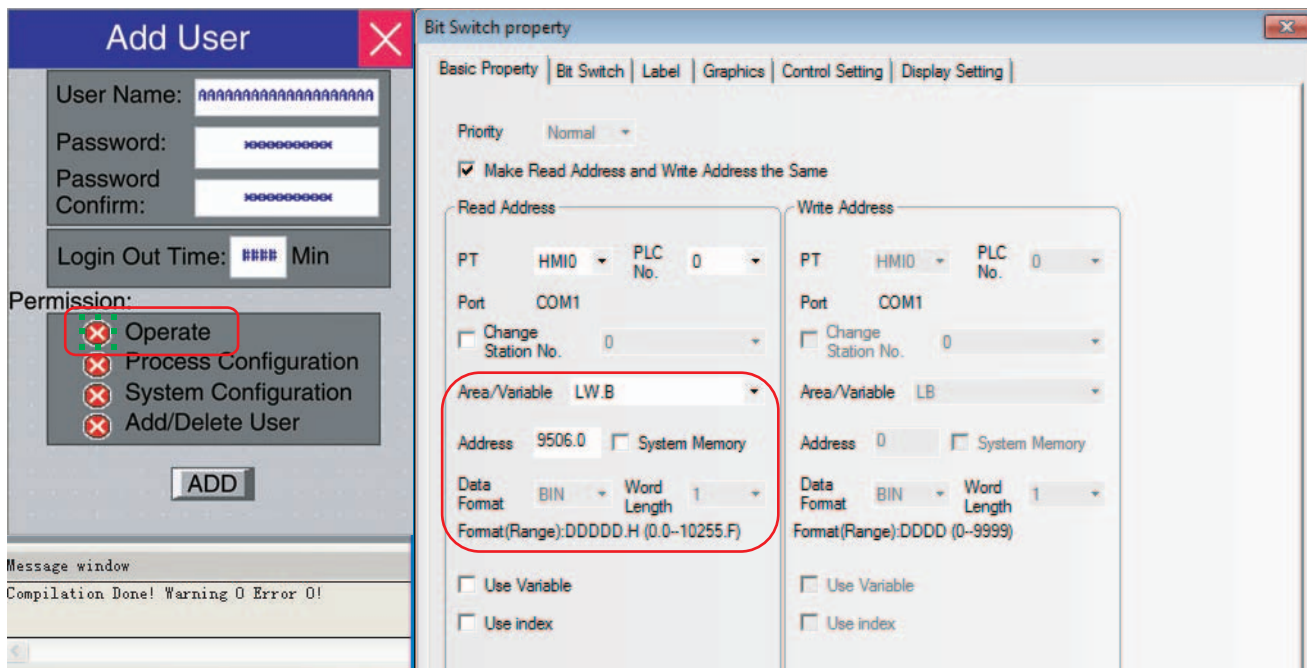

Add User Operation Confirmation: Place one Bit Button component with the address of LW9167 and switch type of "Set" for confirming the added user permission.

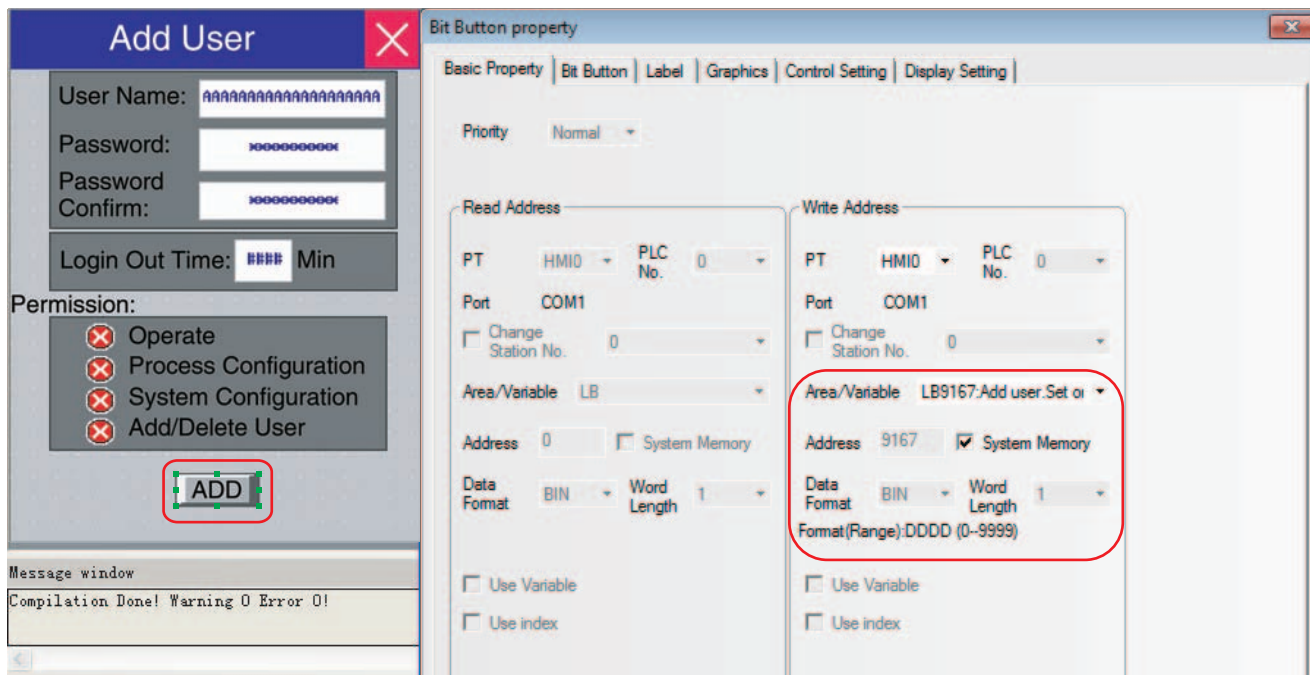

Perform the test and the effect is as shown below:

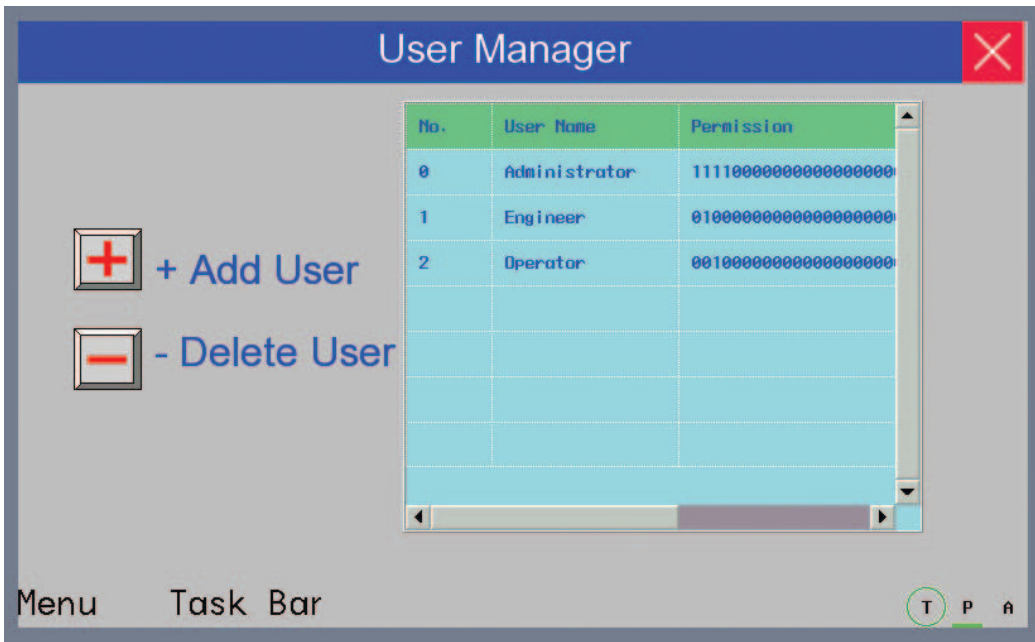

Click [Add User] to make add user dialog box pop up:

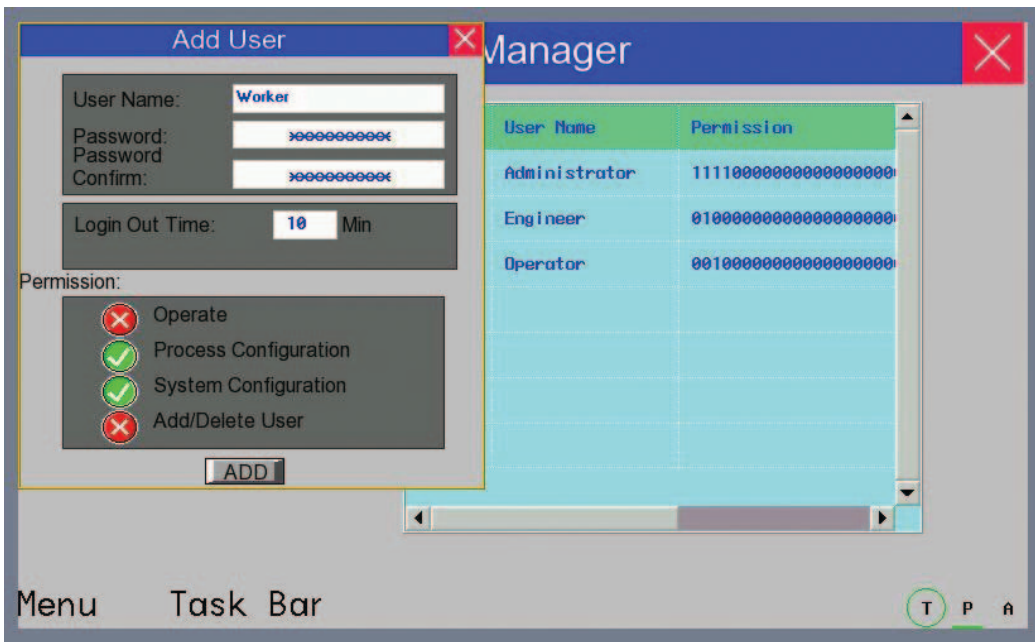

Input the User Name to be added, set the Password and the Password Confirm, and then set the Logout Time for this user and assign the Permission. After the setting, click “ADD” to complete “Add User” operation.

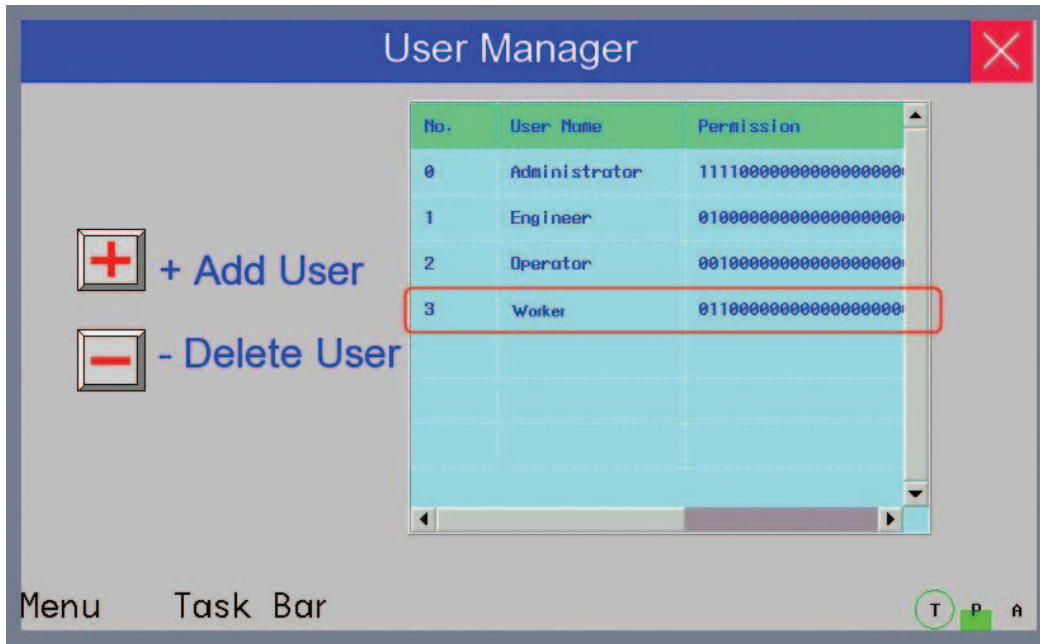

(b) Delete User

“Delete User” screen contains User Name, Password, Password Confirm, Delete User Operation etc.

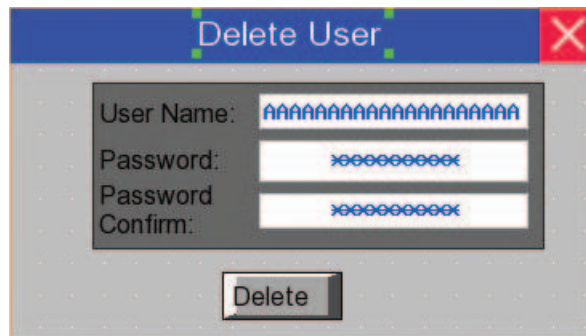

The settings of User Name, Password and Password Confirm are similar to that of “Add User”.

Delete User Operation Confirmation: Place one Bit Button component and specify the address to LW9168 and the switch format to [Set].

**Note** Delete user permission operation is only valid for the users added to the PT. The users set in the NB-Designer can't be deleted.

Perform the offline test and the effect is as shown below:

Click “Delete User” to make Delete User dialog box pop up:

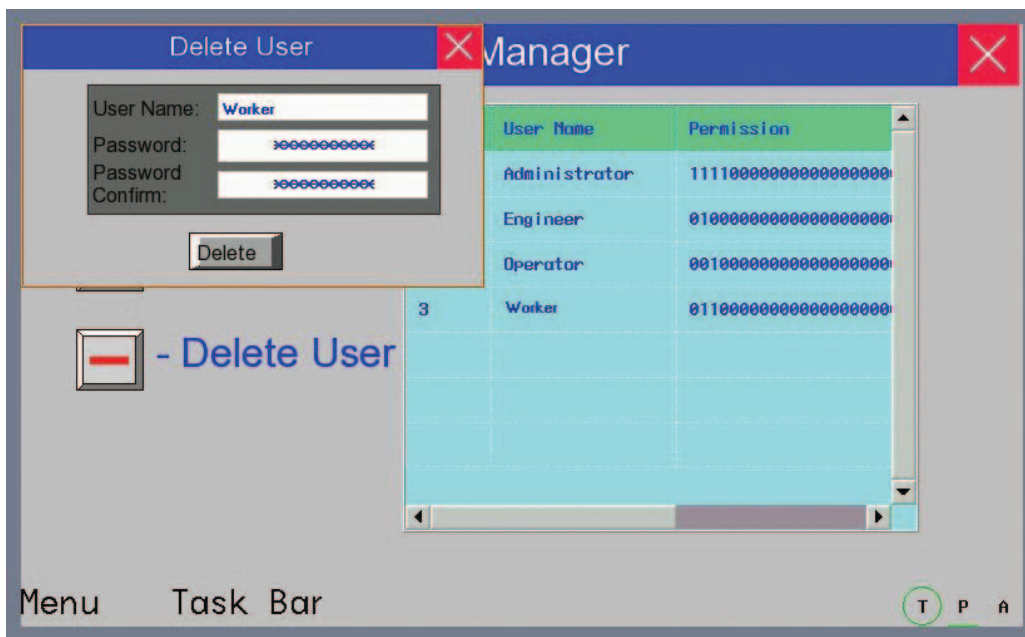

Input the User Name to be deleted, the Password and Password Confirm for this user, then click “Delete” to complete the operation of deleting users.

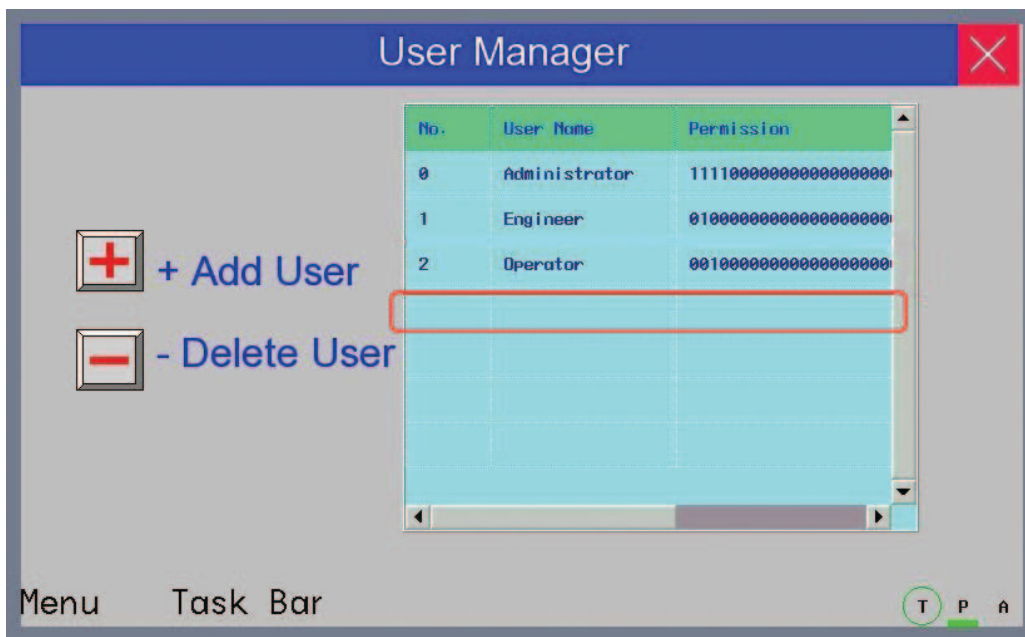

### 3-10-7 Event History Setting

Event History information is stored in the Recipe Data Field.

When the check box [Save to Recipe Data Field] in the [PT Property] is checked, the system stores the Event History information of executed Event to the Recipe Data Field. Since the system automatically performs the storing, the user does not have to care about the method to store the Event History information.

The destination to store the data will be specified from the address set in [Start Address] of the system parameters. The default address is "0".

The data stored to the Recipe Data occupies 16 words for each event. The example of size calculation to store the Event Log is shown as below. The data which was stored in the Recipe Data cannot be exported to external memory.

An example when the starting address of the data to "100" in [Event History Setting] of [PT Property]

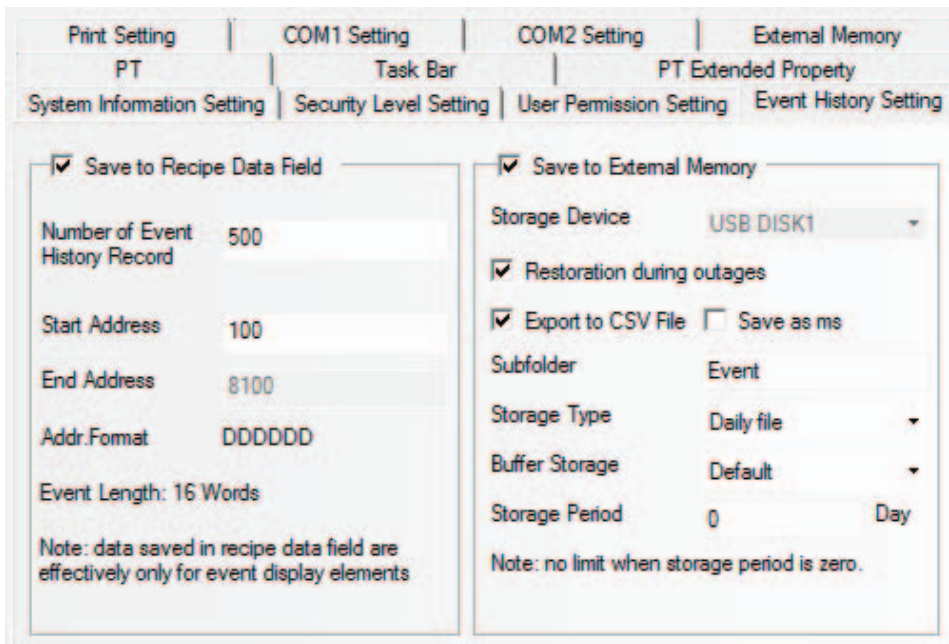

In order to store the Even Log Data, the system automatically reserves a memory area starting from RW100 in the Recipe Data Field. For example, the Event Log management information and 200 of Event History information are stored as below.

Recipe Data Field address	Data
RW100	1st Historical Event
RW116	2nd Historical Event
RW132	3rd Historical Event
RW148	4th Historical Event
.....	.....
.....	.....
RW3268	199th Historical Event
RW3284	200th Historical Event

The size of the stored memory is  $200 \times 16 = 3200$  words. The address of Recipe Data Field is "read only area". If writing is performed to the area, it may result in unpredicted condition. Although the user can specify the starting address freely, pay attentions to the following points.

- (1) The specified addresses cannot be specified overlapped with other components and others.
- When the storage period is set, the file deletion is performed at the first sampling after the startup and every 24 hours. At this moment any files which is beyond the storage period should be deleted.



### 3-10-8 COM1 Setting

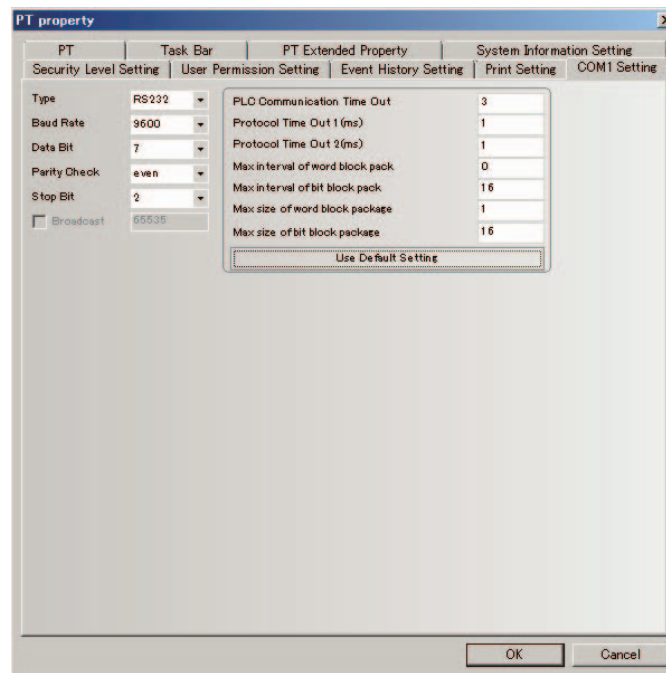

There are [COM1 Setting] here because NB Unit has 1 serial port. You can make the connection to 1 PLC through this serial port.

**Type:** Fixed at RS-232C.

**Baud Rate, Data Bit, Parity Check and Stop Bit:** Selects the communication parameters matching the PLC.

**PLC Communication Time Out:** Determines the time that the PT needs to wait for the PLC response. When the delay time of communication between PLC and the PT exceeds the time expressed by the timeout constant, the system information “PLC No Response” will be displayed in the PT. **Generally, the timeout constant is set automatically during the PLC model selection, and doesn't need to be modified by the user.**

**Protocol Time Out:** Refers to the protocol timeout, **which is set automatically during the PLC selection and doesn't need to be modified.**

**Max interval of word block pack, Max interval of bit block pack, Max size of word block package and Max size of bit block package:** The PT will automatically collect all the PLC data with the consecutive addresses and send one read command to read these data, thus improving communication efficiency and reducing the response time substantially. **Max size of word block package** and **Max size of bit block package** set the maximum numbers of bit memory and word memory that can be read consecutively. These numbers are generally set automatically during the PLC selection and don't need to be modified by the user.

If these PLC data without the consecutive addresses, the PT will send the separate commands to read them, i.e. a lot of read commands are needed to read these data. Therefore, we allow to modify the intervals through the **Max interval of word block pack** and **Max interval of bit block pack**. When the 2 address intervals exceed the settings, they will be divided into 2 data packages to be read, otherwise they will be combined into 1 package. Doing this allows reducing the number of the communications package and improving the communications efficiency.

For example:

As shown below, for the reading of data stored in DM20 to DM29, when the PLC data package is set to 0, the system will use 3 read-commands to read these data respectively. While when “**Max interval of word block pack**” is set to 1, it just needs 1 command to read these data. Generally speaking, the time spent for reading extra 2 addresses (DM23 and DM25) is far less than the time spent for reading 2 data package, thus reducing the time needed for the communication significantly.

DM20
DM21
DM22
DM24
DM25
DM27
DM28
DM29

**Note** This setting does not appear on models that do not support a serial port.

### 3-10-9 Ethernet Communication Setting

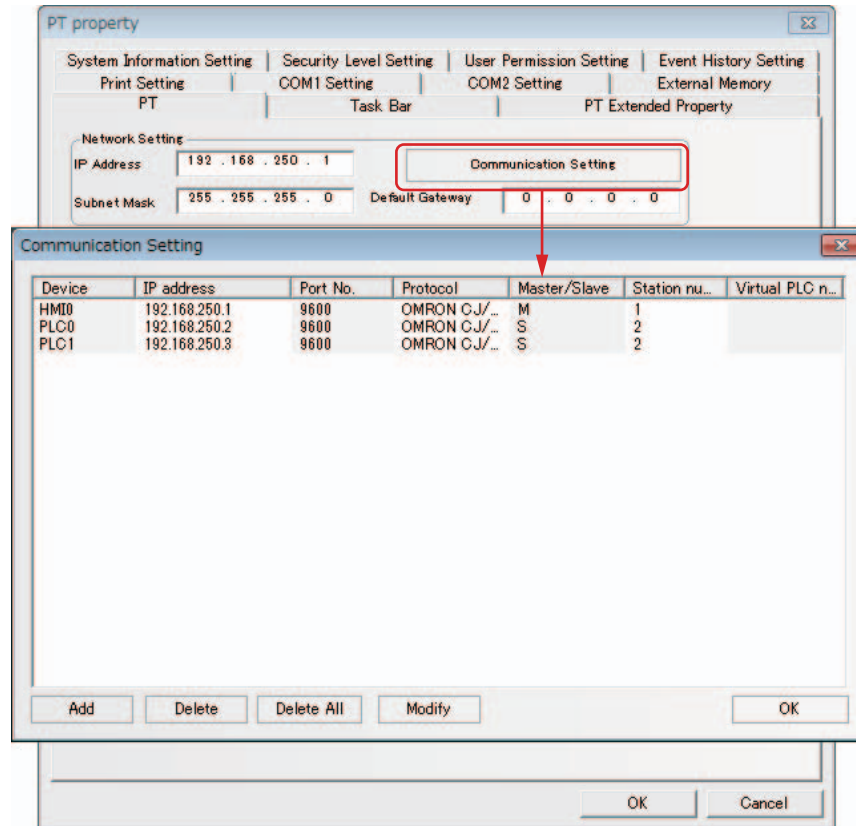

The “Communication Setting” option is used to make the “Communication Setting” for the Ethernet communication, i.e. to configure the Ethernet communication protocol and set some related communication parameters.

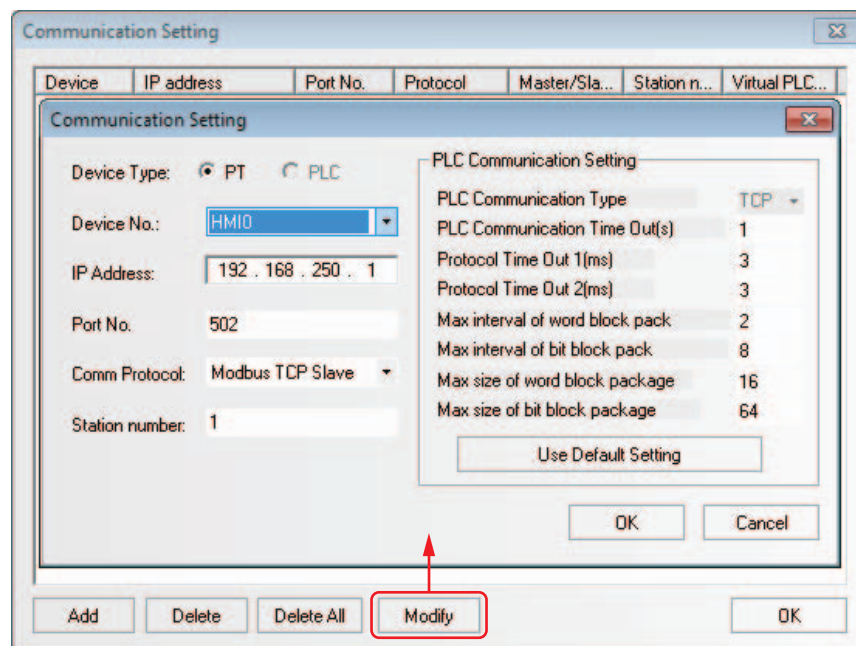

## 3-11 Address of System Memory

The system reserves some addresses of Local Word (LW), Local Bit (LB), Nonvolatile Local Word (LW) for the special purposes, and the user must use these memory addresses according to the related descriptions.

- Local Bit (LB): The reserved range is from LB9000 to LB9999.
- Local Word (LW): The reserved range is from LW9000 to LW9999.
- Nonvolatile Local Word: The reserved range is from LW10000 to LW10255.

These ranges include the read area for the system to notify of its status and the write area for the users to perform some control to the system.

### Descriptions of internal BIT memory:

**LB:** Refers to the local bit address of PT, which can't be retained when power is OFF.

**RB:** Refers to the absolute address of bit address saved in the recipe memory that is stored in the flash memory, which can be retained when the power is OFF. Even if the battery is dead in PT, the data stored in the recipe memory will not be lost.

**RBI:** Refers to the index address of bit address saved in the recipe memory that is stored in the flash memory, which can be retained when the power is OFF. Even if the battery is dead in PT, the data stored in the recipe memory will not be lost.

**LW.B:** Refers to the bit address corresponding to the local word address of PT, which can't be retained when the power is OFF.

**FRB:** Refers to the absolute address of bit address saved in flash memory, which can be retained when the power is OFF. When the battery is dead in PT, the data saved in flash memory will not be affected, but the number of write operations in flash memory is limited.

**FRBI:** Refers to the index address of bit address saved in flash memory, which can be retained when the power is OFF. When the battery is dead in PT, the data saved in the flash memory will not be affected, but the number of write operations in flash memory is limited.

### Descriptions of internal WORD memory:

**LW:** Refers to the local word address of PT, which can't be retained when power is OFF.

**RW:** Refers to the absolute address saved in the recipe memory that is stored in the flash memory, which can be retained when the power is OFF. Even if the battery is dead in PT, the data stored in the recipe memory will not be lost.

**RWI:** Refers to the index address saved in the recipe memory that is stored in the flash memory, which can be retained when the power is OFF. Even if the battery is dead in PT, the data stored in the recipe memory will not be lost.

**FRW:** Refers to the absolute address of word address saved in flash memory, which can be retained when the power is OFF. When the battery is dead in PT, the data saved in flash memory will not be affected, but the number of write operations in flash memory is limited.

**FRWI:** Refers to the index address of word address saved in flash memory, which can be retained when the power is OFF. When the battery is dead in PT, the data saved in the flash memory will not be affected, but the number of write operations in flash memory is limited.

**ERW0-ERW2:** Refers to the recipe word addresses saved in the external memory, which can be retained when the power is OFF. When the battery is dead in PT, the data saved in the external memory will not be affected. This area is not supported on the NB-S series.

**Note RB and RW point to the same area.** For example, RB5.0 to RB5.F and RW5 map the same area, i.e. RB5.0 is the Bit0 of RW5. But **LB and LW map different areas**, and the addresses pointed by them in the memory are different.

## 3-11-1 Local Bit (LB)

Addresses	Descriptions	Comments
9000~9009	Initialization setup is ON.	These bits can be used to make some components turn ON when the system starts the initialization (notification/control).
9010	Download Recipe	The user can use this bit address to confirm the process of recipe download. Set it to ON under download state and set it to OFF after the download is completed (notification).
9011	Upload Recipe	The user can use this bit address to confirm the process of recipe upload. Set to ON under uploading status and to OFF after the upload is completed (notification).
9012	Download / Upload Recipe	The user can use this bit address to confirm the process of recipe download/upload (notification).
9013	Touch indicator	Set it to ON when touching the "Touch indicator" (notification).
9014	CPU Indicator	Set it to ON when touching "CPU Indicator" (notification).
9015	Alarm indicator	Set it to ON when touching "Alarm Indicator" (notification).
9016	Printer error	ON-Error occurred, OFF-No error (notification).
9017	Printer control	ON-Enable printer; OFF-Disable printer; Enabling the printing by system parameters is valid (notification/control).
9018	Backlight state (OFF)	This bit will turn to 1 automatically when the backlight is OFF, and turn to 0 when the backlight is ON (notification).
9019	Backlight state (ON)	This bit will turn to 1 automatically when the backlight is ON, and turn to 0 when the backlight is OFF (notification).
9020	Pen (Turn ON under selected state)	It is one function of the Notepad. It is used to judge whether the pen is under the selected state currently (notification/control).
9021	Eraser (Turn ON under selected state)	It is one function of the Notepad. It is used to judge whether the eraser is under selected state currently (notification/control).
9022	Clear Block (Turn ON under clear block state)	It is one function of the Notepad. It is used to judge whether the block is under "clear block" state currently (notification/control).
9030	Pen size of 1 pixel point	It is one function of the Notepad, which can set the pen size to 1 pixel point (notification/control).
9031	Pen size of 2 pixel points	It is one function of the Notepad, which can set the pen size to 2 pixel points (notification/control).
9032	Pen size of 3 pixel points	It is one function of the Notepad, which can set the pen size to 3 pixel points (notification/control).
9040	Hide/Show Menu Screen	Set it to ON/OFF to hide/show the Menu Screen (notification/control).
9041	Hide/Show task bar	Set it to ON/OFF to hide/show the task bar (notification/control).
9042	Hide/Show operation button	Set it to ON/OFF to hide/show the operation button (notification/control).

Addresses	Descriptions	Comments
9043	Hide/show all (Menu Screen, task bar, operation button)	Set it to ON/OFF to hide/show all the Menu Screens, task bars and operation buttons (notification/control).
9044	Reserved by system	
9045	Restart PT	Set it to ON to perform this function (notification/control).
9046	Beyond the security level	This bit will turn ON when you attempt to switch a screen without a required security level. This bit does not turn OFF automatically (notification).
9050	Return to the status set originally to the project	Set it to ON to perform this function and the system will set the values which are set in the project to the system parameter area of LW10000 or later, and will automatically clear this bit to zero after the settings completed (notification/control). This bit will be turned ON when you attempt to operate an object for which you do not have the security level required. This bit does not turn OFF automatically (notification).
9051	Control the execution of touch operation when the backlight is off.	Setting it to ON can disable the touch operation of PT when the backlight is closed (notification/control).
9052	Disable to write the return value of [PLC Control] / [Switch Screens]	Set it to ON to disable to write Back function of PLC. And it is only applicable to Write Back function of [PLC Control] / [Switch Screens]. The Write Back function is not disabled when the value of LB9052 is OFF. In this case, if you want to switch from Base Screen 10 to Base Screen 12 by using [PLC Control] / [Switch Screens] (Read address: DM20), the switching can be controlled only when the value of DM20 is 12. And the PLC will write 12 back to the word address DM21 automatically after the screen is switched to the Base Screen 12. If the Write Back function is disabled, 12 will not be written back to DM21 (notification/control).
9053	Touch mark	It turns ON when the screen is touched and it turns OFF when the touching is released (notification).
9055	Operation at disconnection: PLC	The operation when the PLC is disconnected with NB Unit will be performed according to the contents of LB9055. OFF: All the commands written to PLC are invalid. ON: Operation is normal (notification/control).
9056	Operation at disconnection: touch control	The operation when the PLC is disconnected with NB Unit will be performed according to the contents of LB9056. OFF: Enable the touch operation. ON: Disable the touch operation (notification/control).
9060~9061	System Keyboard display bits: being displayed in the right of the screen	When the user activates the Number Input Component or Text Input Component located in the left of the screen, the bit turns ON automatically and the keyboard is displayed at the same time. When the input is completed or canceled, the bit turns OFF automatically. The keyboard is closed at the same time (notification).
9062	System Keyboard display bit: Keyboard is displayed from the component placed the upper left of the screen.	The bit turns ON when the keyboard is displayed from the component placed at the upper left of the screen and the bit turns OFF when the keyboard is closed from it (notification).
9063	System Keyboard display bit: Keyboard is displayed from the component placed the lower left of the screen.	The bit turns ON when the keyboard is displayed from the component placed at the lower left of the screen and the bit turns OFF when the keyboard is closed from it (notification).
9064~9065	System Keyboard Display bits: Keyboard is displayed in the left of the screen	The bit turns ON when the keyboard is displayed from the component located in the left of the screen and the bit turns OFF when the keyboard is closed from it (notification).
9066	System Keyboard display bit: Keyboard is displayed from the component located in the upper right of the screen	The bit turns ON when the screen is displayed and the bit turns OFF when the screen is closed (notification).

Addresses	Descriptions	Comments
9067	System Keyboard display bit: Keyboard is displayed from the component located in the lower right of the screen	The bit turns ON when the screen is displayed and the bit turns OFF when the screen is closed (notification).
9068~9069	System Keyboard display bits: Keyboard is displayed from the component located in the screen	The bit turns ON when the screen is displayed and the bit turns OFF when the screen is closed (notification).
9080	System Keyboard display bit: Keyboard is displayed from the component located in the upper half of the screen	The bit turns ON when the screen is displayed and the bit turns OFF when the screen is closed (notification).
9081	System Keyboard display bit: Keyboard is displayed from the component located in the lower half of the screen	The bit turns ON when the screen is displayed and the bit turns OFF when the screen is closed (notification).
9093	Increase backlight brightness	When the bit turns ON, the function to increase the brightness will be executed. After completing the processing, the bit turns OFF (notification/control).
9094	Decrease backlight brightness	When the bit turns ON, the function to decrease the brightness will be executed. After completing the processing, the bit turns OFF (notification/control).
9100	Switch input mode from Pinyin	When the LB9100 is ON it will switch to Pinyin input mode, and when LB9100 is OFF, it will switch to English input mode (notification/control).
9108	Update graphics	When the LB9108 is ON, the bitmap referred by the component on the screen will be updated. After completing the processing, the bit turns OFF (notification/control).
9110	Indicating mode of the data log	Only when LB9110 is ON, the zoom and view functions can be activated, otherwise the traditional default view method of Data Log will be used (notification/control).
9118	Macro operation instruction	This bit will be set to ON during the execution of Macro (reading and writing of memory) and to OFF after the execution is completed (notification).
9120	Trigger buzzer with a long beep	When this bit is set to ON, buzz a long beep. After the beeping, the bit turns OFF (notification/control).
9121	Trigger buzzer with a short beep	When this bit is set to ON, buzz a short beep. After the beeping, the bit turns OFF (notification/control).
9124	Alarm count displaying	When this bit is set to ON, the starting item of Alarm component will display the alarm count (notification/control).
9129	Trigger Base Screen for inputting	When this bit is set to ON, the input components in the Base Screen will be triggered (notification/control).
9130	Executing to clear RW memory	When this bit is set to ON, the RW clearing (The start address and word length are determined by LW9260 and LW9262.) will be triggered (notification/control).
9131	Trigger Number Input automatically	When this bit is set to ON, the Number Input components will be automatically triggered after the screen is opened (notification/control).
9135	Cursor lock	When this bit is set to ON, the cursor will be locked at current Input component and can be switched to other input components only after the input is completed (notification/control).
9136	Filter PLC communication without response	When this bit is set to ON, the PLC communication without response is filtered (notification/control).
9137	Endian Display Text Display Component	When this bit is set to ON, the bytes will be displayed with the endian reversed, i.e. the low bytes are displayed on the right side of the Text Display component (notification/control).

Addresses	Descriptions	Comments
9138	Mask text characters	When this bit is set to ON, the Text Display component only displays the character codes from 0x21 to 0x7F encoded to the space (0x20) (notification/control).
9139	Set at screen switching	When the screen is switched, this bit is set to ON. Even when the screen switching is completed, this bit is not set to OFF automatically (notification).
9140	Caps Lock	When this bit is set to ON, the alphabets will be input in capital form. Numeric keys are switched into symbol keys; numerical entry with a numeric keypad is disabled (notification/control).
9141	Turning OFF the current beep	When this bit is set to ON, the current beeping is stopped and the bit turns OFF (notification/control).
9142	Trigger the input component of pop-up screen	When this bit is set to ON, the input component located on the top of the pop-up screen will be executed (notification/control).
9143	USB printer status	ON-Connecting, OFF-No connecting (notification).
9144	Hide component with communication failure	When this bit is set to ON, the components with the communication failure will not be displayed (notification/control).
9145	Restart automatically after system collapse	When this bit is set to ON, the PT will restart automatically 5 seconds after PT collapse (notification/control).
9150	Execute project/recipe import/export function	When this bit is set to ON, the import/export operation of project or recipe will be executed (notification/control).
9151	Protection bit for project export	This bit will be set to OFF after the upload password is input correctly during the project export; otherwise it will be set to ON (notification/control).
9152	Switch between tree folder and list folder	ON is for tree folder and OFF is for list folder respectively (notification/control).
9154	Inserting and Ejecting USB memory	When USB memory is inserted, it will turn ON and it should be turned OFF before removal to ensure the safe removal of USB memory (notification/control). When the NB does not support a USB host, this bit is always ON.
9157	Deleting files in USB memory	When this bit is set to ON, all the files in the USB memory generated by PT will be deleted (control).
9161	Align-left display on keyboard	When this bit is set to ON, the display component (LW9060) on the keyboard will be displayed in left-aligned way during the input (notification/control).
9162	Vector font optimized display	When this bit is set to ON, the vector font edge display effect will be optimized (notification/control).
9163	Screen display state	When this bit is set to ON, the screen will be displayed vertically reversed. This bit is applicable when the display is horizontally oriented (notification/control).
9165	User login	When this bit is set to ON, the user login operation is performed, and later the bit will be set to OFF automatically (control).
9166	User logout	When this bit is set to ON, the user logoff operation will be performed, and later the bit will be set to OFF automatically (control).
9167	Add user	When this bit is set to ON, the user addition operation will be performed, and later the bit will be set to OFF automatically (control).



Addresses	Descriptions	Comments
9168	Delete user	When this bit is set to ON, the user deletion operation will be performed, and later the bit will be set to OFF automatically (control).
9175	Web interface	When the bit is ON, the Web interface is valid (notification/control).
9210	Soft power off	When this bit set to ON, the software exits. To restore, press the reset button on the back or turn on the power again (control).
9221	Upload CSV	The bit turns ON while the data in ERW is being copied into the CSV file (notification).
9231	Download CSV	The bit turns ON while the data in the CSV file is being copied into the ERW area (notification).
9251	Printing event manually (not currently support)	When it is set to ON, forced printing of triggered events up to now will be executed (notification/control).
9272	Enable to change communication setting	This bit is set in the area to change communication setting. A permitted communication setting by the bit takes effect after a reboot. Be sure to reboot the NB after setting communications (control). Communication setting change area: LW9685-LW9691
9290	Enable VNC	When this bit is set to ON, the VNC server will be enabled (notification/control).
9291	VNC mode setting	When this bit is set to ON, the VNC server will be enabled only in monitor mode. When this bit is set to OFF, the VNC server will be enabled both in monitor mode and operation mode (notification/control).
9292	Setting VNC operation mode password	When this bit is set to ON, the password for VNC server's operation mode will be enabled (notification/control).
9293	Setting VNC monitor mode password	When this bit is set to ON, the password for VNC server's monitor mode will be enabled (notification/control).
9296	Enable FTP	When this bit is set to ON, the FTP server will be enabled (notification/control).

● **About Keyboard Display Bits:**

NB Unit divides the whole screen into 4 areas with the same size from the center, as shown below:

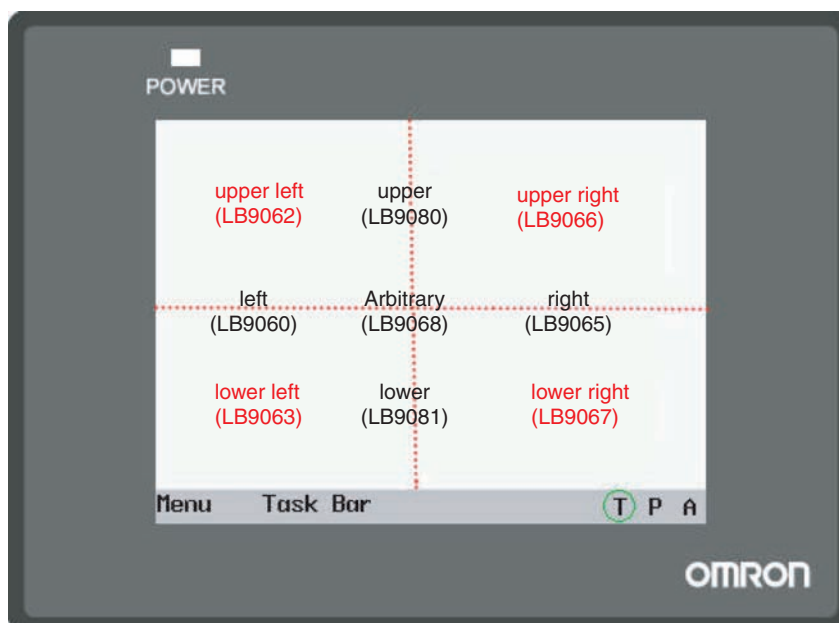

For each area, there is/are one or more address bit(s) corresponding to it. When the Text Input or Number Input in the screen is triggered, the corresponding address bit(s) will be turned ON.

For example: When the Text Input or Number input in the left side of the screen is triggered, a keyboard will pop up in the position where the specified Direct Screen locates, and at the same time, LB9060, LB9061, LB9068 and LB9069 will be turned ON by the system. If the component is in the upper left side, LB9062 and LB9080 will also be turned ON.

**Note** LB9060 and LB9061 have the same display function (i.e. to turn ON or OFF simultaneously) and it is the same with LB9064 and LB9065, LB9068 and LB9069.

**3-11-2 Local Word (LW)**

Addresses	Descriptions	Comments
9000~9001	Index address of recipe data	RWI and RBI use this index address to access the recipe data with low byte address of 9000 and high byte address of 9001 (notification/control).
9002~9003	Maximum input number	The maximum number will be specified when the Number Input component is activated. Otherwise the bits will be specified to 0 (notification).
9004~9005	Minimum input number	The minimum number will be specified when the Number Input component is activated. Otherwise the bits will be specified to 0 (notification).
9006	Notepad operation mode	It is one function of the Notepad, which can be used to select the operation modes from Pen (0), Eraser (1), and Clear Block (2) (notification/control).
9007	Pen Size	It is one function of the Notepad, which can be used to select different pen size from 1 to 8 pixels with Word Length of 1 (notification/control).
9008	Pen Color	It is one function of the Notepad, which can be used to select the pen color from 0 to 65535 (16-bit color) (notification/control).

Addresses	Descriptions	Comments
9010	Local time	Second: Effective value ranges from 0 to 59 (notification).
9011	When the [Use External Clock] option is checked in the [PT Extended Properties] tab in the [PT Property] dialog box, the event will not use the PT time but read the values from LW9010 to LW9017. Using this function needs to transfer the values in the time memories of PLC to LW9010~LW9017 accordingly in advance.	Minute: Effective value ranges from 0 to 59 (notification).
9012		Hour: Effective value ranges from 0 to 23 (notification).
9013		Day: Effective value ranges from 1 to 31 (notification).
9014		Mouth: Effective value ranges from 1 to 12 (notification).
9015		Year: Effective value ranges from 2000 to 2037 (notification).
9016		Week: Effective value ranges from 0 to 6 (notification).
9017		Millisecond: Effective value ranges from 0 to 999 (notification).
9020		Interrupt
9030~9031	Touch coordinate	Records the touch coordinate taking the upper left side of screen as origin (notification).
9034~9035	System time	Double-word. The time calculated with 0.1s as unit is displayed (notification).
9040~9041	Security level password	Double-word. Refer to 3-13 Security Level (Page 3-353) in <i>NB-Designer Operation</i> for details (control).
9042	Security level	Displays the security level of current Base Screen. Refer to 3-13 Security Level (Page 3-353) in <i>NB-Designer Operation</i> for details (notification).
9043	Switch security level forcefully	Forcefully switches from higher security level (e.g. level 2) to lower security level (e.g. level 0). Refer to 3-13 Security Level (Page 3-353) in <i>NB-Designer Operation</i> for details (control).
9050	Display Screen No.	The number of Display Screen No. is specified. Synchronizing with the PLC by Data Transmitting Component allows the PLC to execute the screen transition (notification/control).
9054	Printing format1	<ul style="list-style-type: none"> <li>• Bit0: Text (0:No print, 1:Print)</li> <li>• Bit1: Analog meter (0:No print, 1:Print)</li> <li>• Bit2: Data log (0:No print, 1:Print)</li> <li>• Bit3: Bitmap (0:No print, 1:Print)</li> <li>• Bit4: Vector graphics (0:No print, 1:Print)</li> <li>• Bit5: Screen background (0:No print, 1:Print)</li> </ul> (notification/control)
9055	Printing format2	<ul style="list-style-type: none"> <li>• Bit0~7: Zoom (x0.1) (Range:1~50)</li> <li>• Bit8: Color mode (0:Color, 1:Monochrome)</li> <li>• Bit9: Print page (0:Current page, 1:Reserved)</li> <li>• Bit10: Orientation (0:Landscape, 1:Portrait)</li> <li>• Bit12: Invert color (0:Normal, 1:Inverted)</li> </ul> (notification/control)
9057	Size of each item of the event history	The recipe memory is used to save the size of each item by the event log data (notification).
9058~9059	Size of event log data	The recipe memory is used to store the size of event history including management information (notification).

Addresses	Descriptions	Comments
9060~9075	Display of number input or text input process	Displays the data input by Number Input or Text Input component in real time, and clears it after completion of input. If input component is set to 1 word, only LW9075 is used; while LW9074 and LW9075 are both used if input component is set to 2 words, and so on (notification).
9091	Project compilation [year]	Records the project compilation time [year] (notification).
9092	Project compilation [month]	Records the project compilation time [month] (notification).
9093	Project compilation [day]	Records the project compilation time [day] (notification).
9100 9101	Modify dynamically the address in the screen (internal address)	9100 is the Screen No. The 9101 is the offset (notification/control). When LW9100 is set to 11 and LW9101 is set to 20, the PLC addresses of all the component in the screen 11 will be modified dynamically to the addresses in which the offset are added. i.e. D10 will become D30 and the offset of $20 \times 16 = 320$ will be added to all bit addresses, i.e. M20 will become M340.
9130	Dynamic modification of Text Library	The value of this LW represents the index of Text Library (notification/control).
9136~9137	Currently available memory space [byte]	Double-word. The currently available memory space is stored. Do not write values (notification).
9138~9139	The total memory [byte]	Double-word. The total memory is stored. Do not write values (notification).
9140	Display brightness level	Displays the brightness level for NB Unit with the range from 0 (completely dark) to 32 (completely bright). The setting is linked with Brightness of the System Menu of NB Unit. The value is retained when power is OFF (notification/control).
9150	Character code displayed in the current screen when using Pinyin	The value of LW9150 is the No. of Chinese characters displayed in the current Chinese character display screen (notification).
9152~9167	Characters displayed by Chinese pinyin input	Display Pinyin character input currently when using Pinyin (notification).
9170	Page up/down of Note Book component	The value of this LW means the start line of input area (notification).
9180~9187	Maximum value of Number Input	Text display of maximum value of Number Input (notification).
9190~9197	Minimum value of Number Input	Text display of minimum value of Number Input (notification).
9200~9205	Time value of browsing point of Data Log	These six words are used to display second, minute, hour, day, month and year respectively in BIN code (notification).
9210	Display values of each channel during referencing	The current value of each channel is displayed one by one according to the bit width of the browsed Data Log (notification).
9260~9261	Start address for RW clearing operation	Sets the start address for RW clearing operation triggered by LB9130 (notification/control).
9262~9263	Word length of RW clearing operation	Sets the word length for RW clearing operation triggered by LB9130 (notification/control).
9264~9279	Mask code of PLC Station No.(COM 2)	Each bit corresponds to one Station No. of COM 2 (i.e. 9264.0 corresponds to Station No. 0... and 9279.F corresponds to Station No. 255). When the bit is turned ON, the communication corresponding to Station No. will be stopped. The value is retained when power is OFF (notification/control).

Addresses	Descriptions	Comments
9296~9299	Mask code of error information	Each bit corresponds to one piece of error information. When the bit is turned ON, the corresponding prompt error information will not be displayed. Refer to 3-11-4 System Information Table (Page 3-332) in NB-Designer Operation for details. (notification/control).
9300	Name of path referred by File List component	The name of path currently referred (32 words) by the File List Component will be specified (notification).
9332	Name of file selected by File List component	The name of file selected (32 words) by the File List Component will be specified (notification/control).
9364	Setting Import and Export	Specify the Import and Export of the project and the Recipe (notification/control).
9366	Description of processing File Browsing Component	"1" indicates Copy, "2" does Cut, and "3" does Paste, respectively (control).
9370	Confirm Operation method	Confirm Operation method: 1: Confirm; 2: Cancel (control).
9371	General-purpose PLC control time-out	Automatically stops a general-purpose PLC control if the general-purpose PLC control has not been performed before elapsing the time (second) that you set here. The default is 0 (not to stop the control) (notification/control).
9380~9395	History value of Number Input component	Specify the data set before the input operation (notification).
9416~9431	Index memory for Station No. variable	Each word corresponds to the index (0~15) for Station No. variable (notification/control).
9432~9447	memory for indicating communication state (COM 2)	Each bit corresponds to one Station No. (9432.0 corresponds to 0,..., and 9447.F corresponds to 255). The relevant bit is set to ON when PLC is under time-out condition and has no response, otherwise it will be set to OFF (notification).
9465	Time-out ratio of Macro	Specify the maximum time allocating to the execution of a Macro. The time multiplying the default value, 200 ms with the specified value will be the maximum time (notification/control).
9470~9485	File name of the screen shot	The prefix text string of 16 words naming the screen shot which is stored in USB memory (notification/control).
9486~9501	User name	Inputs the login user name of up to 32 characters (notification/control).
9502~9503	User password	Inputs the password corresponding to the login user (notification/control).
9504~9505	Current user permission	Displays 32 authorities corresponding to current login users (notification).
9506~9507	Authority setting	Double-words and 32 authorities' assignments. LW9506 to LW9507 corresponds to 32 authorities (No. 0 to No. 31) and LW.B corresponds to each bit in LW9506 to LW9507. For example: LW.B 9506.0 represents the authority of No. 0; and LW.B 9506.A represents the authority of No. 10 (control).
9508~9509	Automatic Logout Time setting	Sets the unit of automatic logout time to minute during the addition of user information (control).
9510~9511	Password Confirm	Inputs the password again for consistency confirmation during the addition of user information (control).
9520~9521	Curser position	Refers to the curser position (X,Y) in input component (notification).
9535	The multiplication factor of the communication time for the Macro instruction	If it is specified to "N", the maximum communication time of the Macro external value is N times as long as the default (notification/control).

Addresses	Descriptions	Comments
9536	The multiplication factor of the communication time for writing operation by the data transmission component	Sets a time-out period of writing by data transmission component. The setting value is the coefficient for the maximum size of a block package that is set in the communication settings. Refer to 5-3 Abnormality Handling (Page 5-6) for details (notification/control).
9537	The multiplication factor of the communication time for reading operation by the data transmission component	Sets a time-out period of reading by data transmission component. The setting value is the coefficient for the maximum size of a block package that is set in the communication settings. Refer to 5-3 Abnormality Handling (Page 5-6) for details (notification/control).
9551~9554	Notifying error information	Each bit corresponds to each error information. When the bit turns ON, the bit indicates that the corresponded error information occurs. Refer to 3-11-4 System Information Table (Page 3-340) in <i>NB-Designer Operation</i> for details (notification).
9605~9606	Communication Control	Communication via a port is stopped when a bit for each port is ON. The value is retained when power is OFF (notification/control). Note: OFF (communication allowed) is default. 9605.0: COM2 port 9605.1: Reserved 9605.2: COM1 port 9605.3~9606.A: An Ethernet host is allocated in ascending order of the station number (24 hosts). 9606.B and later: Reserved
9607~9608	Number of flash memory rewrites	Indicates the number of times the block on the flash memory has been rewritten most frequently (notification).
9609~9610	Number of bad blocks on flash memory	Indicates the number of bad blocks on the flash memory (notification).
9685	Communication setting change for a host	Set a PLC number to designate a host whose Ethernet communication setting is to be changed. PLC number is set from 3 in ascending order, not from the PLC number itself. Used in combination with LB9272 (control).
9686~9689	IP address for communication setting-changed host	Set a host's IP address whose communication setting is to be changed. Used in combination with LB9272 (notification/control). [Sample] IP address: 192.168.250.1 LW9686:192, LW9687:168, LW9688:250, LW9689:1
9690	Port number for communication setting-changed host	Set a host's port number whose communication setting is to be changed. Used in combination with LB9272 (notification /control).
9691	Node number for communication setting-changed host	Designate a host's FINS node address whose communication setting is to be changed (notification /control). Enter the same value as the least IP address.
9800~9801	Error code of the triggering error	(notification/control)

### 3-11-3 Nonvolatile Local Word (LW10000~10255)

#### RTC

Addresses	Descriptions	Comments
10000	RTC (second)	BIN code with effective value ranging from 0 to 59 (notification/control)
10001	RTC (minute)	BIN code with effective value ranging from 0 to 59 (notification/control)
10002	RTC (hour)	BIN code with effective value ranging from 0 to 23 (notification/control)
10003	RTC (day)	BIN code with effective value ranging from 0 to 31 (notification/control)
10004	RTC (month)	BIN code with effective value ranging from 1 to 12 (notification/control)
10005	RTC (year)	BIN code with effective value ranging from 1971 to 2037 (notification/control)
10006	RTC (week)	BIN code with effective value ranging from 0 to 6 (notification/control)

#### Description of RTC:

Users can use the related "Component" to display the time. Pay attention to the effective range. The operation when the values out of the effective range is not ensured.

For example: "second" can not be written as 78 (BIN), otherwise RTC will continue in sequence (78 79 80 ...), which may result in unexpected error.

#### Others:

The following notification or control addresses are retained even if power failure occurs. The addresses other than Backlight saver, Buzzer, Password will be valid after the restart.

#### System parameter settings

Addresses	Descriptions	Comments
10010	No. of Initial Screen	It ranges from 0 to 32767.
10011	Backlight saver	0 (Disable Backlight saver) 1 to 600 minutes (enabled)
10012	Buzzer	0: Disabled, 1: Enabled
10013	Common Sheet/Pop-up Screen	0: Normal, 1: At the top of all the other screens
10014	Placing Common Sheet	0: At the bottom of Base Screen, 1: At the top of Base Screen
10015	Number of stored events	It ranges from 0 to 65535. If it is set to "0", the event data will be cleared after the restart.
10016	Source of RTC	0: Internal RTC, 1: PLC (LW)
10017	Default language	It ranges from 0 to 31.
10018	Reserved by system	

#### Security level

Addresses	Descriptions	Comments
10022~ 10023	Password/0	Reserved.
10024~ 10025	Password/1	Double-word is occupied.
10026~ 10027	Password/2	Double-word is occupied.
10118~ 10143	Password/3 to 15	Double-word is occupied × 13.

**Initial Communications Parameters**

Addresses	Descriptions	Comments
9039	FINS node address of the NB Units	If it is changed, restart is needed
10030~ 10033	IP Address of the NB Units	If it is changed, restart is needed i.e. IP Address: 192.168.250.1 LW10030:1, LW10031:250, LW10032:168, LW10033:192
10034	Port Number of the NB Unit	If it is changed, restart is needed
10035	Reserved by system	
10036	COM 2 operation mode	0: RS-232, 1: RS-422, 2: RS-485.
10037~ 10038	COM 2 Baud Rate	Double-word.
Addresses	Descriptions	Comments
10039	COM 2 Data Bit	
10040	COM 2 Parity Bit	
10041	COM 2 Stop Bit	
10042	COM 2 Station No. (PT Station No.)	
10043~ 10044	COM 2 PLC timeout duration	
10045~ 10046	COM 2 Protocol Time Out 1	
10047~ 10048	COM 2 Protocol Time Out 2	

**Note** The addresses 9,039 and greater than 10,000 cannot be modified during simulation. But the read operation is available (For example, the Number Input component with the address of LW10005 will be displayed as 2006 during the test, and it can't be modified to the other value during the test. But it can be modified only after it is downloaded to the PT. ).

**3-11-4 System Information Table**

Address		Information	Descriptions
Word	Bit		
Mask 9296	0	System Error	It is system error which means the error occurs inside the PT.
	1	PLC Response Error	PLC response error: PLC responds with one piece of unexpected information which may caused by the read or write command. Please check if the device functions well.
Notify 9550	2	PLC No Response: cc-pp-d	PLC No Response: the 3 groups of numbers following PLC No Response represent the PT No., PLC Station No. and Serial Port No. respectively.
	3	Reserved by system	
	4	Socket Connect Error	Connection with the PLC and others failed. Check if the devices function normally.
	5	Socket COMM Error	An error occurred during the connection with the PLC and others. Check if the devices function normally.
	6	Macro Code Error: [xxxx] (Macro No.)	An error occurred during executing a Macro. The description enclosed by the parenthesis is the Macro No.



Address		Information	Descriptions
Word	Bit		
Mask 9296	7	Print Error	Printing error: It is followed by the error code. Refer to 7-5 <i>List of Error Codes for Printing (Page 7-9)</i> in <i>NB-Designer Operation</i> for details.
Notify 9550	8	Send Package Error	Message transmission fails.
	9	Memory Shortage	Memory is not enough.
	10	BCD Transform Overflow	BCD conversion overflows.
	11	MacroCode Timeout: [xxxx] (Macro No.)	A timeout occurred during executing a Macro. The description enclosed by the parenthesis is the Macro No.
	12	Reserved by system	
	13	Reserved by system	
	14	RW Area Access Overflow	RW area access exceeds the limits.
	15	Waiting to Print	It indicates waiting for print.
Mask 9297	0	Server Not Ready	The data in server is not ready.
	1	Reserved by system	
Notify 9551	2	Transmit Data Failed	The data transmission failed.
	3	Data Input Failed	The number input failed.
	4	Device Error	Failure occurs in the device.
	5	Copying File ...	The file is being copied (This is the normal prompt during the project export or screenshot operation).
	6	Copy File Failed	The file copy failed (during exporting the project or performing screen shot).
	7	Invalid File	The files objected of importing are invalid.
	8	Password Error	The password is invalid.
	9	Reserved by system	
	10	USB Disk1 Full	USB memory 1 is full already.
	11	Reserved by system	
	12-15	Reserved by system	
Mask 9298	0	RTC Device Error	An error occurred in RTC clock.
	1	Reserved by system	
Notify 9552	2	Invalid UserName	The user name is invalid (The input user name is invalid during the user login or user addition/deletion operations.)
	3	Operation Complete	It indicates the operation is successful (This is the correct prompt displayed after user addition/deletion or password modification.)
	4	Print Busy	It indicates printing.
	5-15	Reserved by system	
Mask 9299	0-15	Reserved by system	
Notify 9553			

## 3-12 Recipe Data

The component of the Recipe transmits the data with consecutive memories. And the data can be downloaded from the recipe memory to the PLC or uploaded from the PLC to the recipe memory. The size of the data to be transferred can be set. For the NB Unit, the recipe memory with 128K word can be selected for recipe data storage.

### 3-12-1 Process of Creating One Recipe Component

- 1 Drag the icon of Recipe to the Edit Window,  and then fill the contents in [Basic Properties] tab:

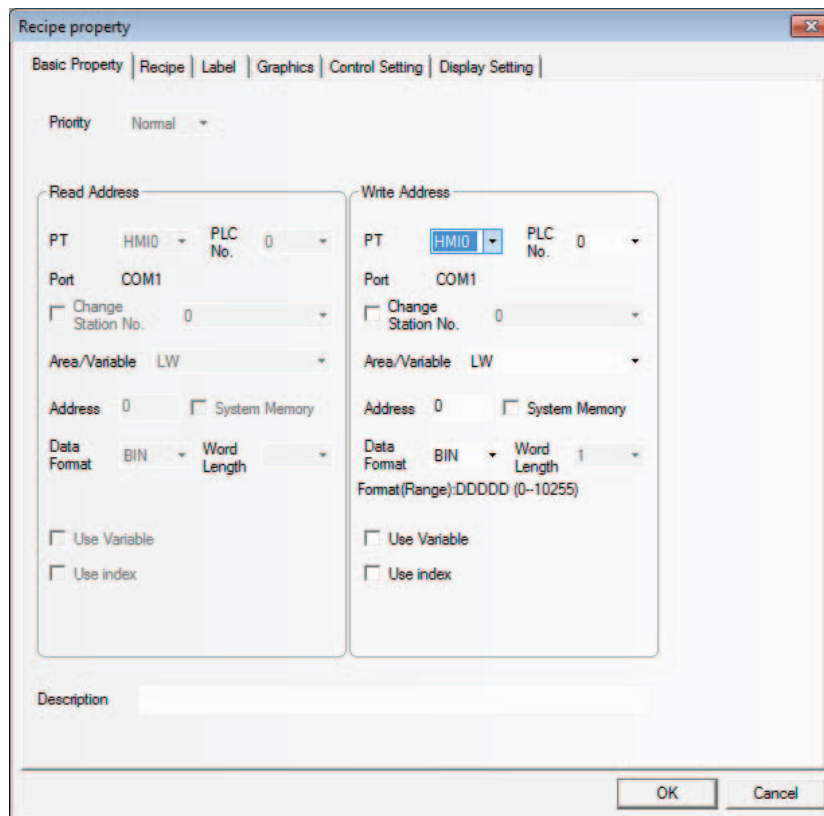

**Write Address:** Specify the starting address of the PLC which transmits the Recipe data. The address for [Data Length] specified in the [Recipe] tab of the [Recipe Property] dialog box are used for the data transmission with the Read Address on the top.

**Address:** Specify the starting address at the PLC to transmit the Recipe data.

**Word Length:** The function does not support the parameter.

- 2** Switch to the [Recipe] tab and set the Function and Data Length.

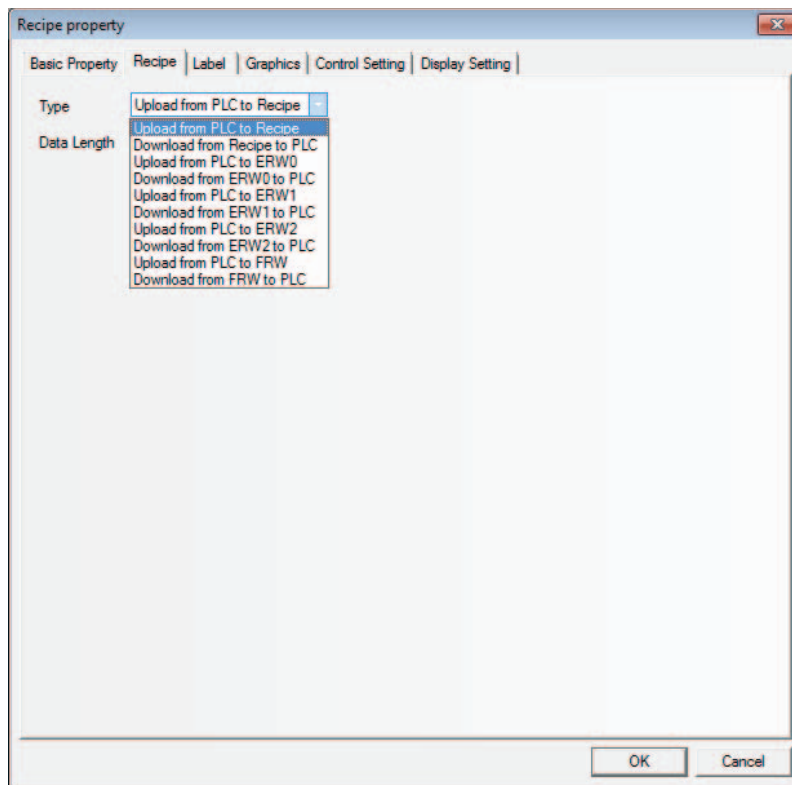

**Function:**

**Upload from PLC to Recipe:** Transfers the data from PLC to the recipe memory of PT.

**Download from Recipe to PLC:** Transfers the data from the recipe memory of PT to PLC.

**Transmit from PLC to FRW:** Transmit the data from PLC to the Recipe memory ERW.

**Transmit from ERW to PLC:** Transmit the data from the Recipe memory ERW of PT to PLC.

**Upload from PLC to FRW:** Transfers the data from PLC to the recipe memory FRW of PT.

**Download from FRW to PLC:** Transfers the data from the recipe memory FRW of PT to PLC.

**Data Length:** Refers to the word length of the data to be transferred.

- 3** Switch to the [Label] tab and add the different displayed texts corresponding to the different states.
- 4** Switch to the [Graphics] tab and select the Vector Graphics or Bitmap to display the graphics corresponding to the state of the Recipe Data component.
- 5** Switch to the [Control Setting] tab and make the Security Setting and set the Triggering action.
- 6** Press the [OK] button, and adjust the position and size of the component.

### 3-12-2 Recipe Memory

The recipe memory stores in a flash memory, and even if power interruption occurs, the data can be retained.

The recipe memory space of NB3Q/NB5Q-TW□□B model is 128K (Word), and for that of NB7W/NB10W-TW□□B model, it is 256K (Word).

There are 2 indication methods for the recipe memory, i.e. “RW” represents the absolute address while “RWI” represents the index address. The data in “LW9000” is the offset of the index address. For example, when the data in LW9000 is 50, the index address RWI0 will point to the data in address RW50. In this case, if we change the data in LW9000 to 51, then the index address RWI0 will point to the data in address RW51, as shown below:

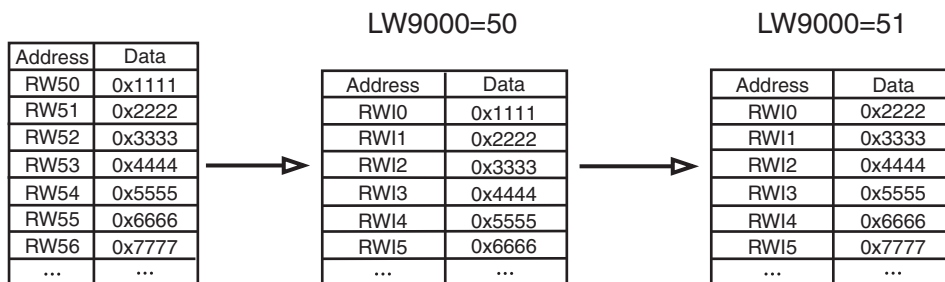

For example, we specify one project and select [MODBUS RTU] as the PLC Type in system parameters. The function of transferring the 5-word text beginning from address 200 with the address type of 4X to the address of recipe memory (RW300) is as shown below:

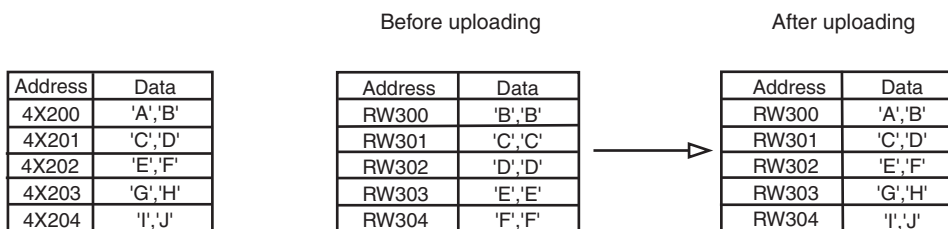

Create a new project and select [MODBUS RTU] as the PLC type in [Project Library Window].

Firstly, create a component to upload the recipe data with the Area/Variable of 4X, Address of 200, Function of Upload, Word Length of 5, and [Transport Font] being checked, and the Label of “Upload”, as shown below:

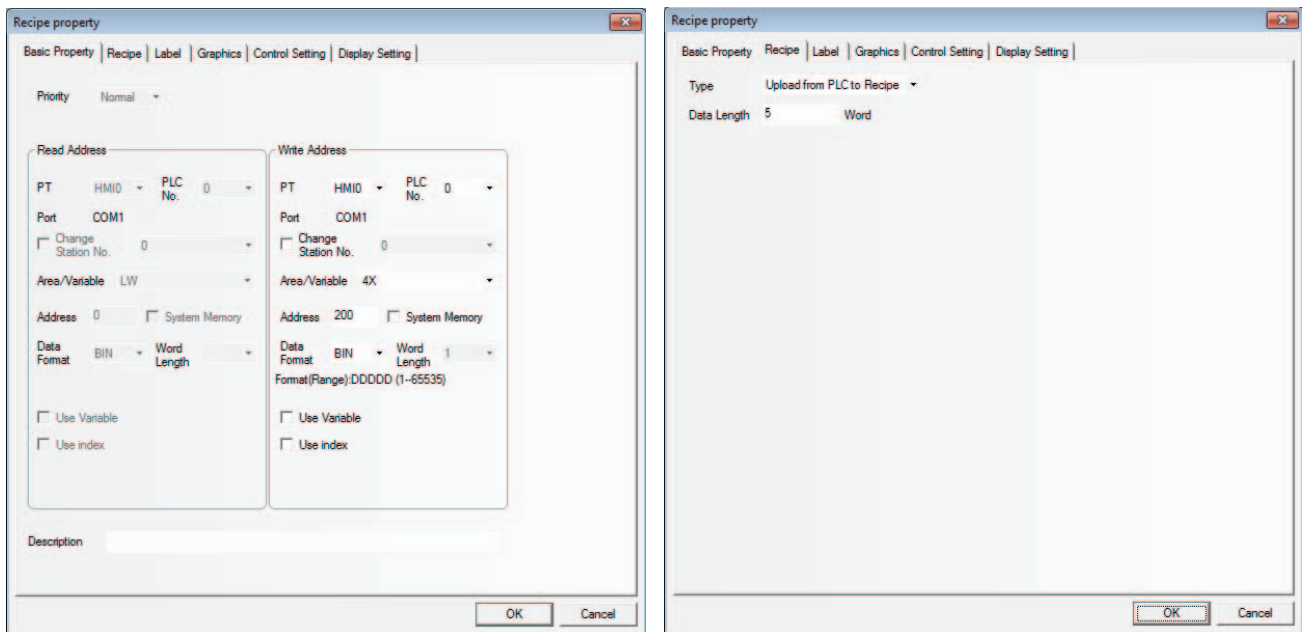

Then place the component in the screen.

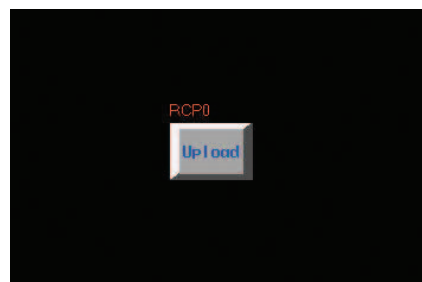

Now the recipe data transmission component is created, but it can only specify to transfer the 5 words beginning from address of 4X200 to the recipe memory instead of the specific position of the recipe memory. Set the LW9000 to 300 and press “Upload” button, then the 5 words beginning from 4X200 will be transferred to the 5-word addresses after the start address of RW300. If you want to transfer the 5 words beginning from the address of 4X200 to RW100 again, then you just need to set LW9000 to 100, and then press “Upload” button to complete the data transmission.

Place 3 Text Input components to modify/display the data.

- (1) 4X200: Area/Variable of 4X, Address of 200 and Word Length of 5.
- (2) RW10: Area/Variable of RWI, Address of 0 and Word Length of 5.
- (3) RW300: Area/Variable of RW, Address of 300 and Word Length of 5.

Then create one Number Input component to modify the data of LW9000. Specify LW for [Area/Variable] and 9000 for [Address].

After Save, Compile operations, perform the offline test for the project. Firstly, change LW9000 to 300 (because LW9000 represents the offset of the index address, RWI0 will display the data in the address of RW300), as shown below:

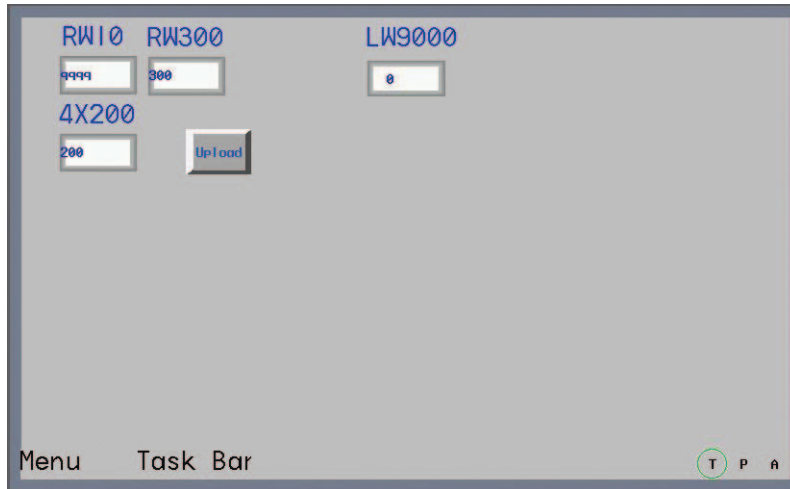

Input "QWERTYUIOP" to 4X200, and 300 to LW9000, then you will find the data displayed by RWI0, RW300 and 4X200 is the same after the Upload button is pressed, as shown below, which means the upload is successful.

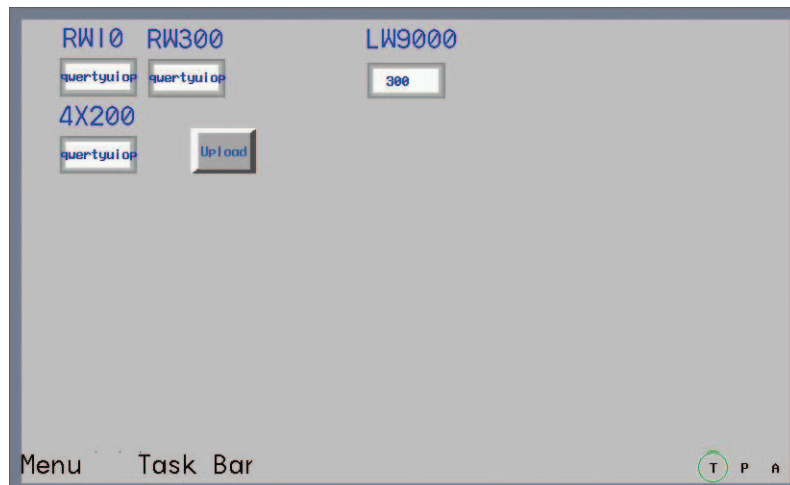

How to download the 5 words with the start address of RW300 to the position with the start address of 4X200? The specific operation process is described as follows. Add one recipe data transmission component in the project just mentioned above with the Area/Variable of 4X, Address of 200, Function of Download from Recipe to PLC, Word Length of 5 and Label of "Download".

Perform the offline test, change LW9000 to 300 and input “123456” to RWI0, as shown below:

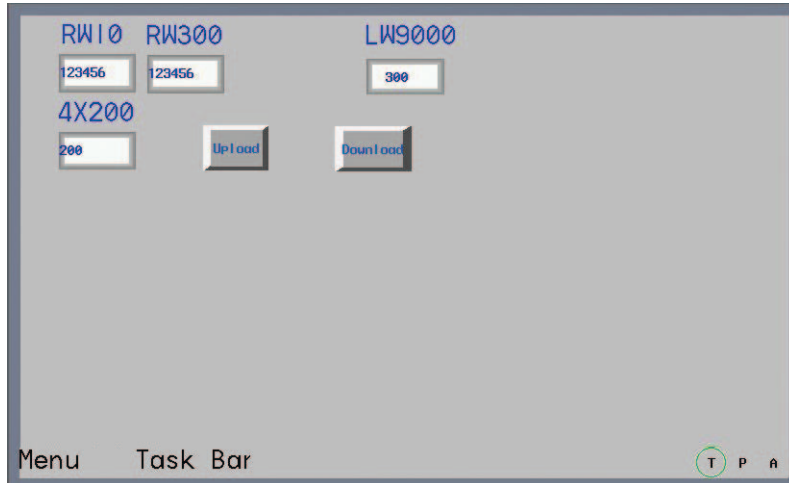

Press the Download button, then you will find the text data will be transferred to 4X200 from RW300.

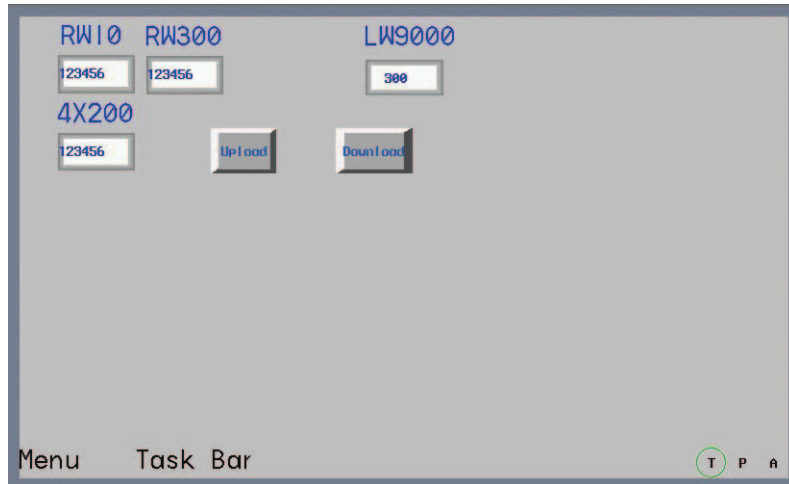

Whether we upload the data from PLC to recipe or download the data from recipe to PLC, **the start address of data in recipe is always the value corresponding to LW9000.**

### 3-12-3 Upload/Download of Recipe Data between PT and PLC

The recipe data is significantly useful. For example, the production device can operate differently according to the different parameters assigned to them on the industrial production line. Now, we can save this group of data in the specific format in the recipe memory, then we can call them out directly, thus enhancing productivity.

#### ● Example of how to call several recipe data conveniently

It is assumed that we have 10 groups of recipes; each group is made of 5 words, recipe name occupying 4 words and recipe data occupying 1 word. Then we configure the recipe from RW0, as shown below:

Recipe No.	memory Address	Recipe Name (4 words)	Recipe Data (1 word)
Group 0	RW0-RW4	“AAAAAAA”	0
Group 1	RW5-RW9	“BBBBBBB”	1111
Group 2	RW10-RW14	“CCCCCCC”	2222
Group 3	RW15-RW19	“DDDDDDD”	3333
Group 4	RW20-RW24	“EEEEEEE”	4444
Group 5	RW25-RW29	“FFFFFFF”	5555
Group 6	RW30-RW34	“GGGGGGG”	6666
Group 7	RW35-RW39	“HHHHHHH”	7777
Group 8	RW40-RW44	“IIIIIII”	8888
Group 9	RW45-RW49	“JJJJJJJ”	9999

We hope each group of recipe in the above table can perform data swap with 4X100 memory of our PLC conveniently through design. First, let's see the following created project to obtain the general understanding. RWI0 and RWI4 in the project display the data in Group 0, and pressing the Download button can download the recipe data to 4X100 while pressing the Upload button can upload the data in 4X100 to the recipe memory. The Up button on the right is used to modify the Recipe No. to a level smaller, which is convenient to change or transfer the recipe data; and the Down button on the right side is used to modify the Recipe No. to a level larger.





Firstly create a new project, and select the [MODBUS RTU] as the PLC in [Project Library Window].

- 1 Create one Text Input component with Word Length of 4 to display and change the name of each group of recipes.
- 2 Create one Number Input component to display and change each group of recipe data.

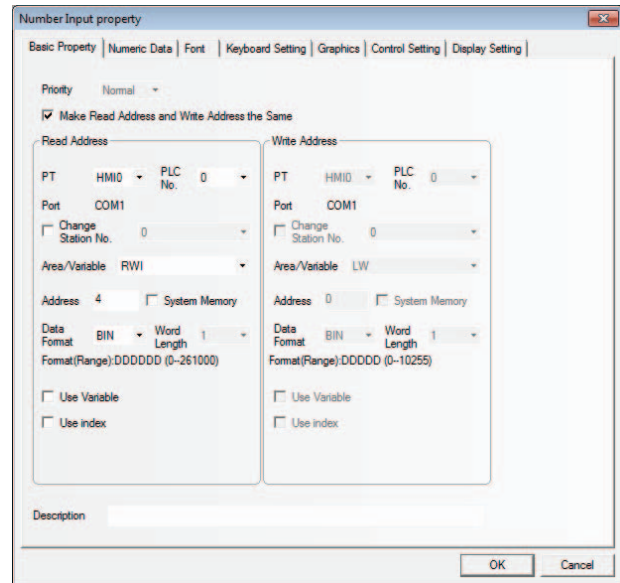
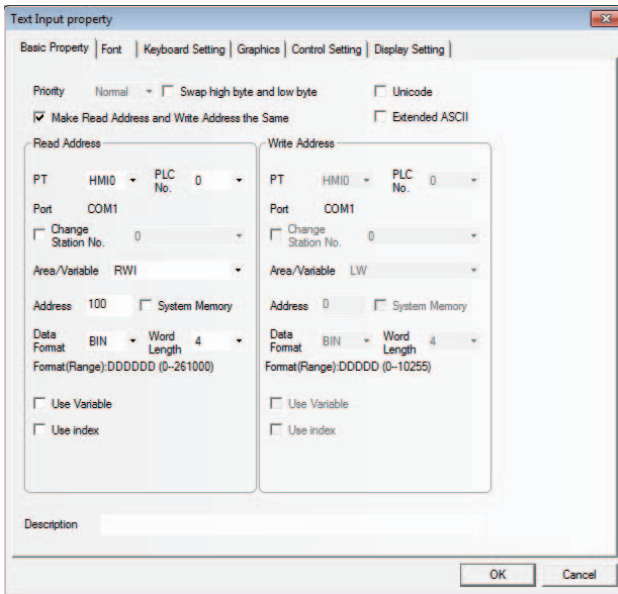

- 3 Create one Text Input component and one Number Input component to display and change the recipe data in PLC.

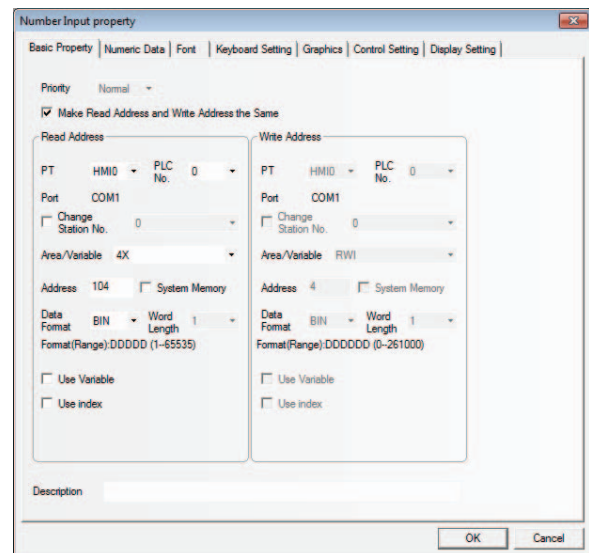
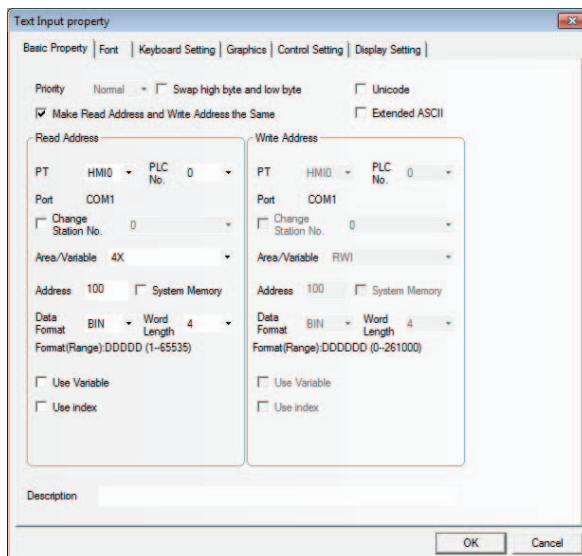

- 4 Create two recipe data transmission components with both addresses of 4X100, and one component is used to download the recipe data and the other is used to upload the recipe data.
- 5 Design two Command Button components (Up and Down) for the user to retrieve and change each group of recipe data conveniently. After the Up button is pressed for retrieving data upwards, the system will subtract 5 from LW9000. Because each group of recipe data is made of 5 words, each time the Up button is pressed, RWI0 displays the Recipe data with a smaller Recipe No. group. After the Down button is pressed for retrieving data downwards, the system will add 5 to LW9000. Because each group of recipe data is made of 5 words, so each time the Down button is pressed, RWI0 displays the Recipe data with a larger Recipe No. group. The upper limit of recipe data is 45 (10 groups of recipes), as shown below:

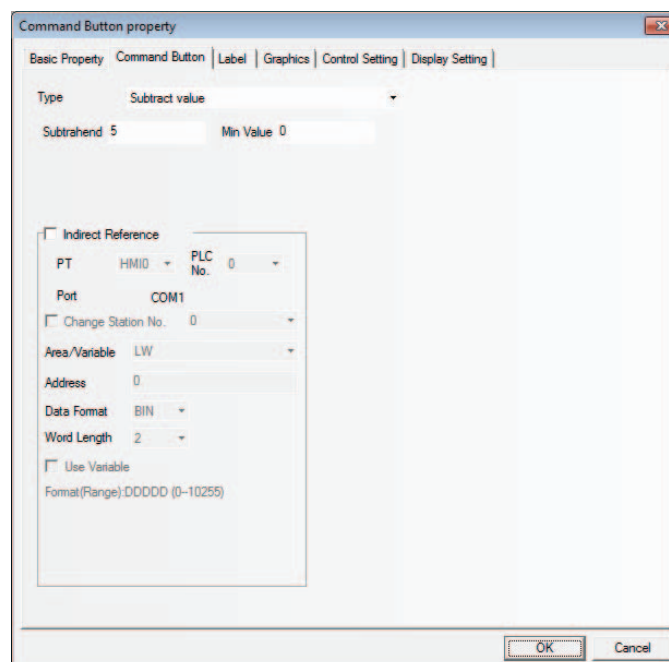
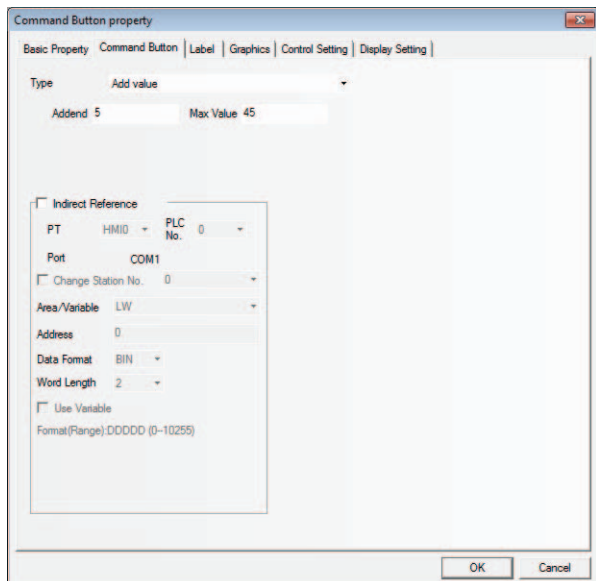
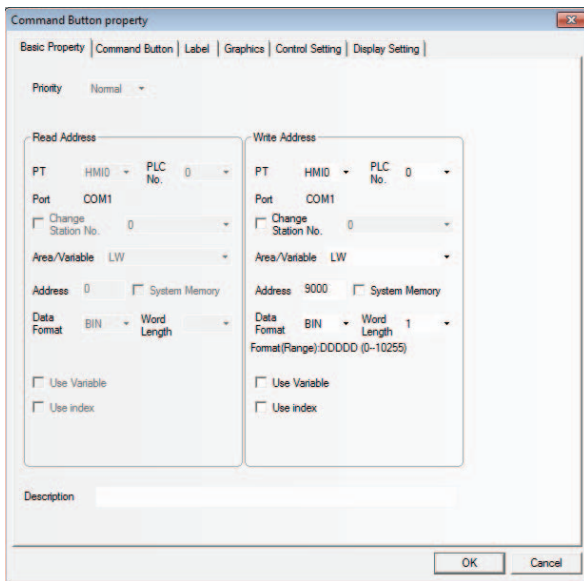

**6** Show which group is selected currently.

Later, create another two Command Button components with address of LW0 for both of them, and Setting Mode of “Subtract value” and “Add value” respectively. And no graphics is needed.

Overlay the component of “Add value” on “Down” button which was created at the step 4. Overlay the component of “Subtract Value” on “Up” button which was created at step 4. The value of LW0 will vary accordingly, and it will display the group where the current recipe data locate, as shown below:

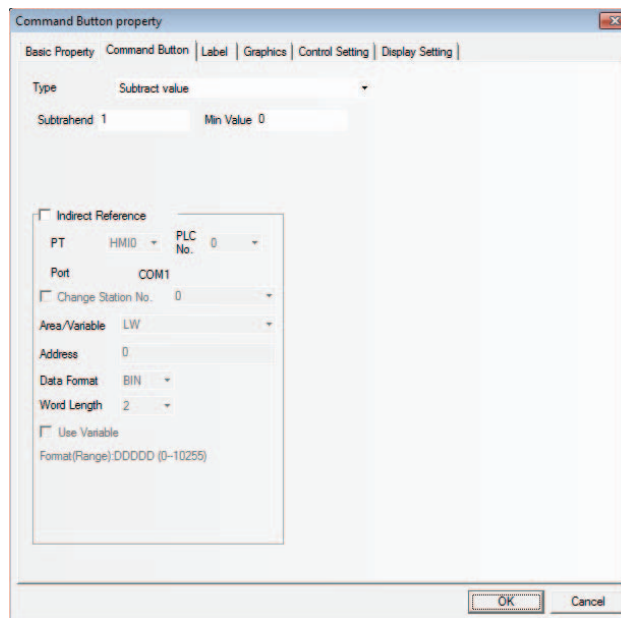
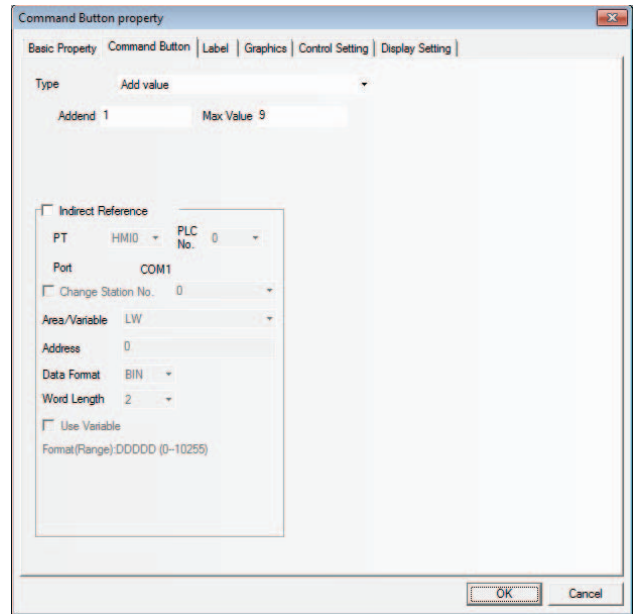
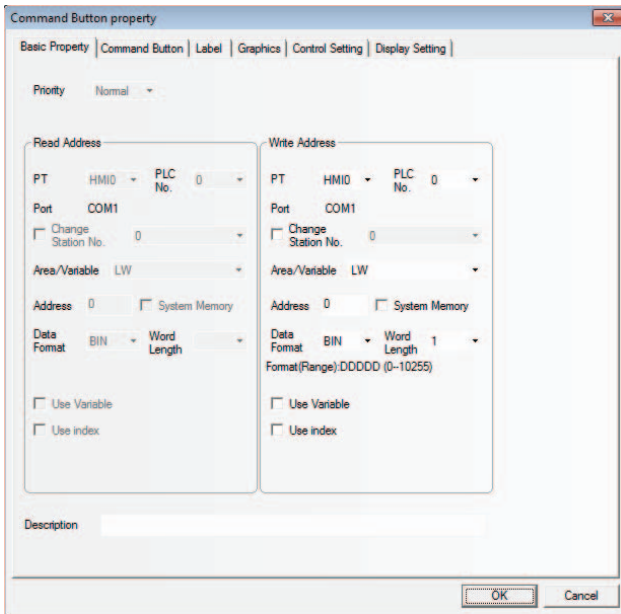

- Place another keyboard in the screen, and add some texts for decoration, then the project is thoroughly completed.



After Save, Compile operations, perform the offline test for the project.



Input the 10 groups of recipe data into the recipe memory one by one, then switch to Group 8 of recipe data to change the name to "KKKKKKKK", recipe data to "1234", then you will see the data in 4X100 and 4X104 will become "KKKKKKKK" and "1234" respectively after the Download button is pressed, as shown below:



## 3-13 Security Level

Security Level is used to set the access authority for different users to enhance the security of the project. Only the user having the high-level password can access the high-level screen, thus enhancing the security of the project significantly.

When setting Screen Property, we can see one column of "Security Level". That's to say, we can specify the Security Level for any screen, as shown below:

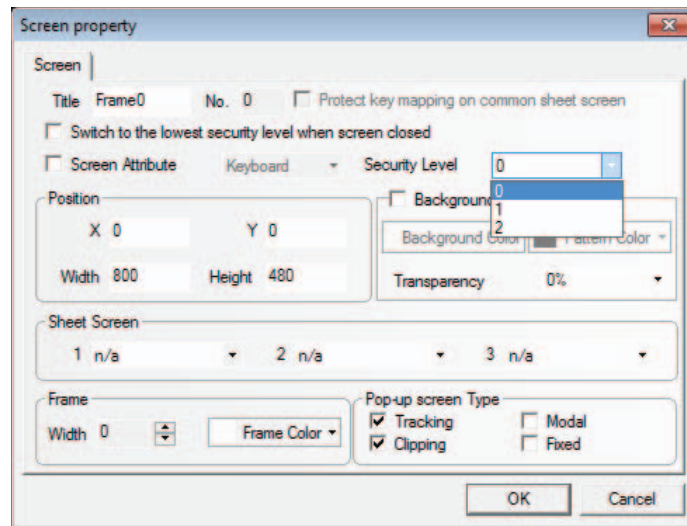

**The Security Level is only valid for the Base Screen.** One project has 3 Security Levels, i.e. High (2), Common (1) and Low (0) by default. The default security level is Low when creating a new screen. You can set different passwords for each security level in the [PT Property]. **The user with higher security level can access the screen with the lower security level, while the user with the lower security level can't access the screen with the higher security level.** Such kind of method is helpful to the security management. For example, we can place the important switches into the screen with the higher security level, so the user can't access them after they enter this screen, and the contents can be accessed only after the password for the higher security level is input.

Here is an example about security level usage: Firstly, select [File] / [New], and double-click PT in the Project Work Space, then set The number of Security Levels to 3, 1-level Password to 1111 and 2-level Password to 888888 in Security Levels Setting tab of PT Property dialog box, as shown below:

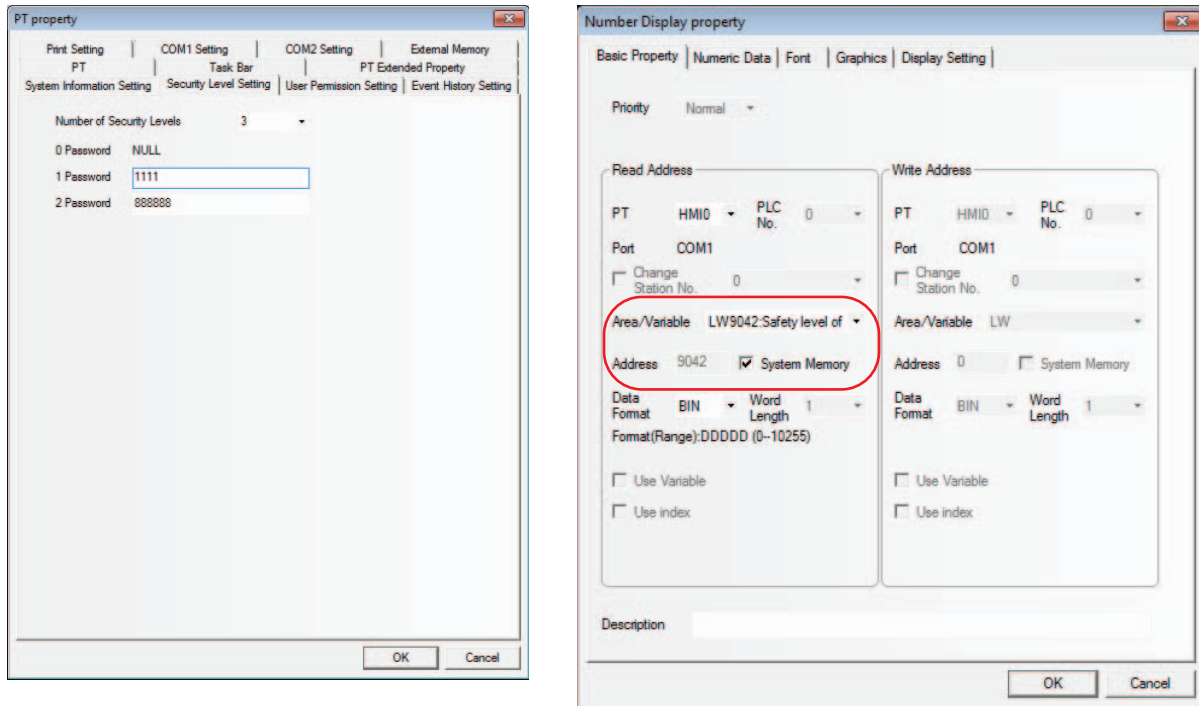

**LW9042 reserved by the system is used to indicate the security level of the current Base Screen.** Create one Number Display component and place it into Frame 0 to display the current security level, as shown below.

The project is shown as the lower left graphics and the effect is as shown in the lower right graphics after Save, Compile and Offline test operations are done.

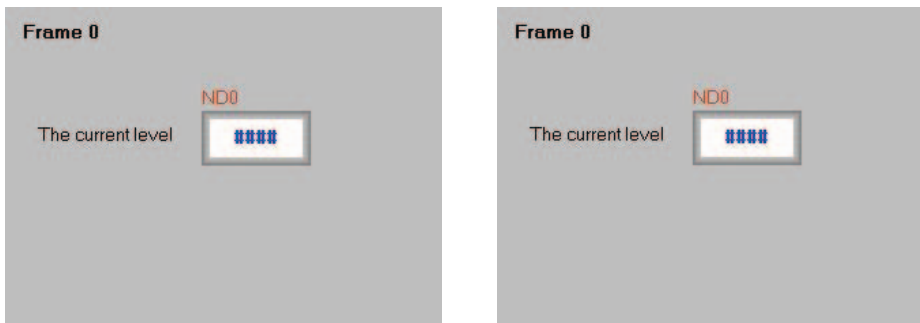

Because no password is input, the security level at initial state should be 0. Then specify the security level to Common (1) in Screen Property of Frame 10 as below.

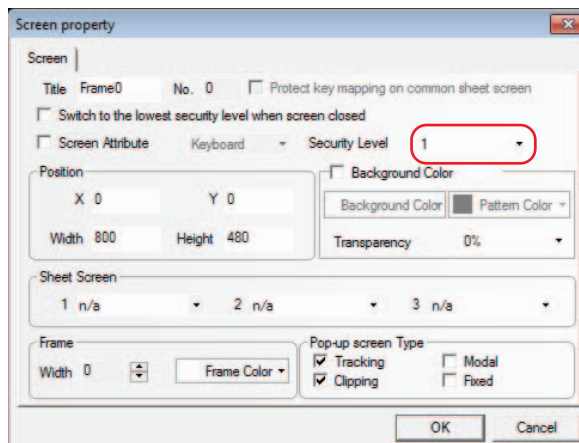

Create one Function Key in Frame 0 with the Properties as follows:

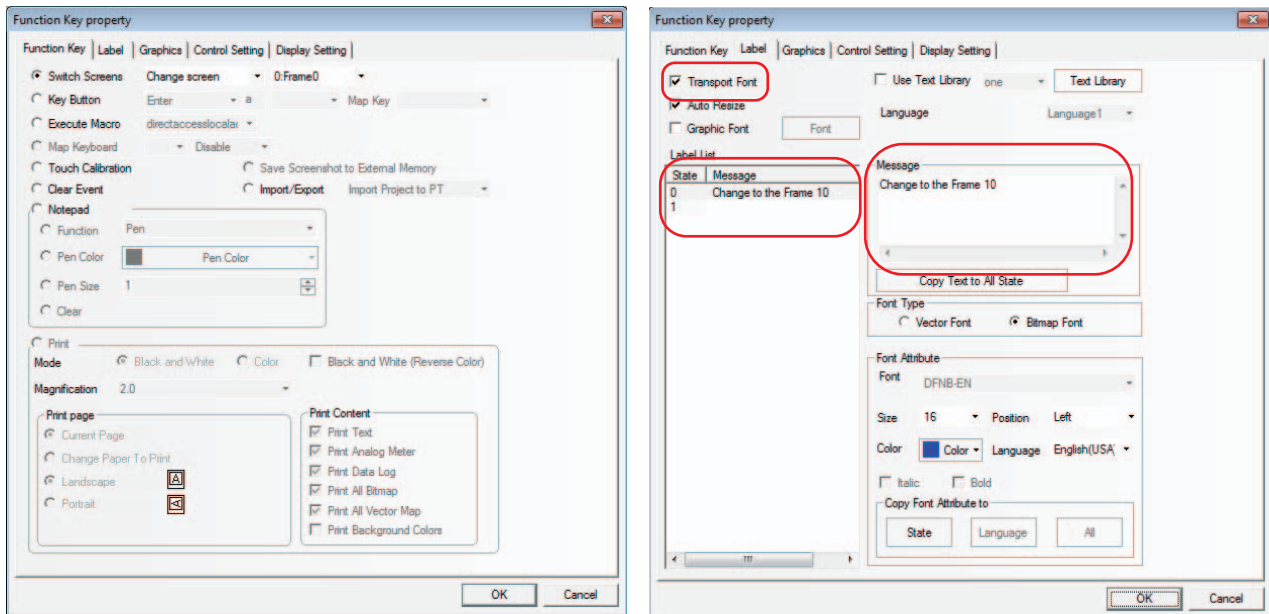

Perform Save, Compile and Offline test operations, and the effect is as shown below:

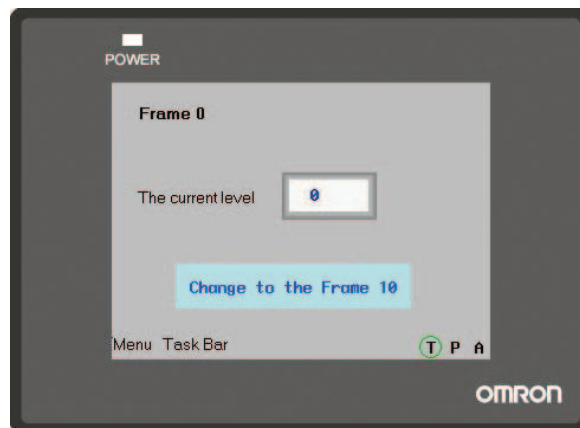

Pressing the Function Key button can't switch to Frame 10. It is because the current security level is 0 while the security level of Frame 10 is 1, so the screen with the higher security level can't be accessed from the screen with the lower security level. We can access the higher security level screen only after inputting the password corresponding to the higher security level. **LW9040 to LW9041 reserved by the system are used to input the security level passwords.** Then place another Number Input component with the Storage Format of "password" in Frame 0, as shown below:

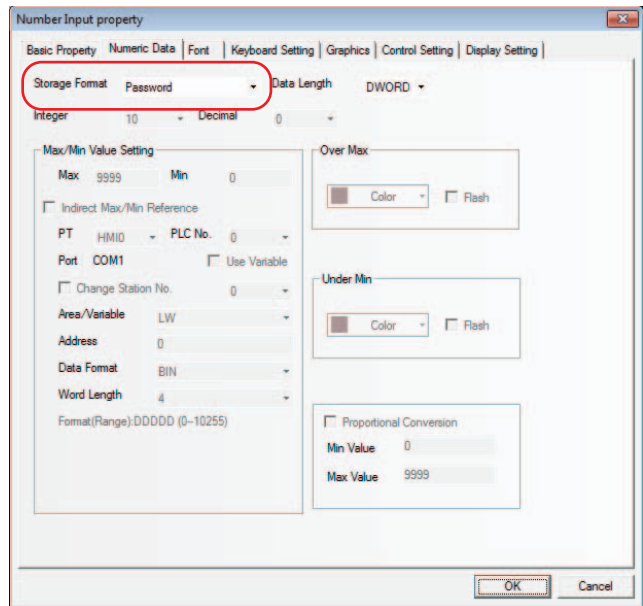
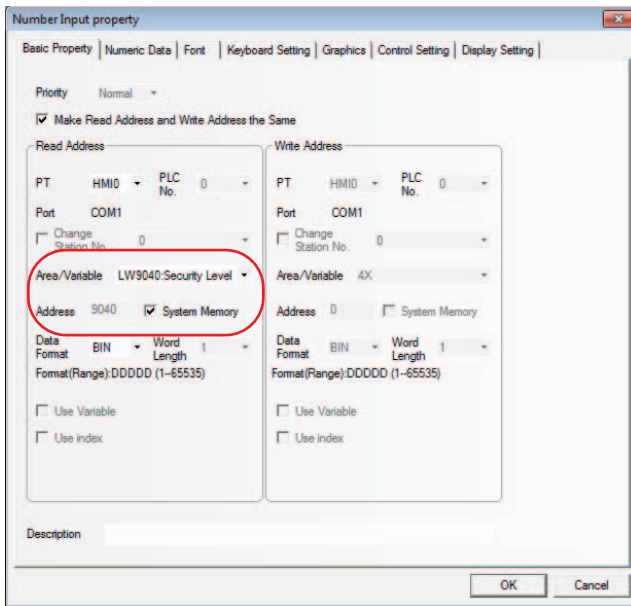

**Note** Since the system memories from LW9040 to LW9041 are used because of password input, the word length should be set to 2 words.

After the Save, Compile and Offline test operations are performed; the effect is shown as the lower left graphics: Pressing Change screen button is invalid for the current level is 0, and when the password of 1111 is input, the current security level becomes 1, as shown below:

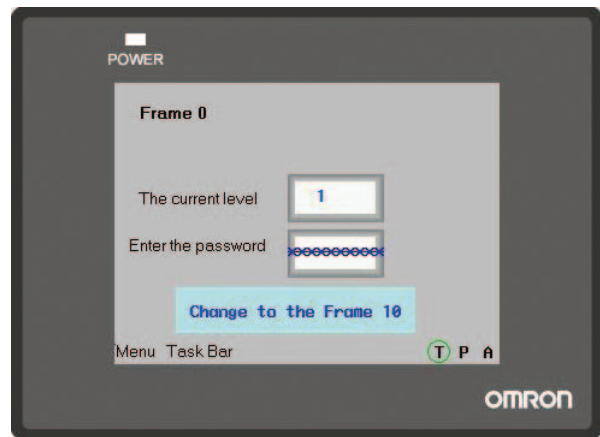
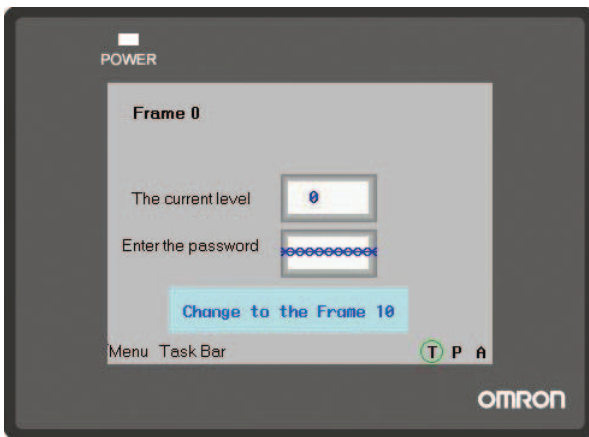



Now the current security level has become 1, the screen will switch to Frame 10 successfully when the Change screen button is pressed, as shown below:

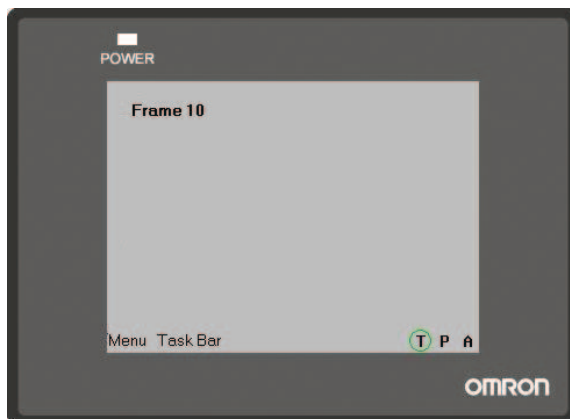

When the current security level is High, how to switch to Low level? **LW9043 reserved by the system is used to perform the switching from the higher level to lower level. And the switching from lower level to higher level is impossible.** Place one Number Input component in Frame 0, as shown below:

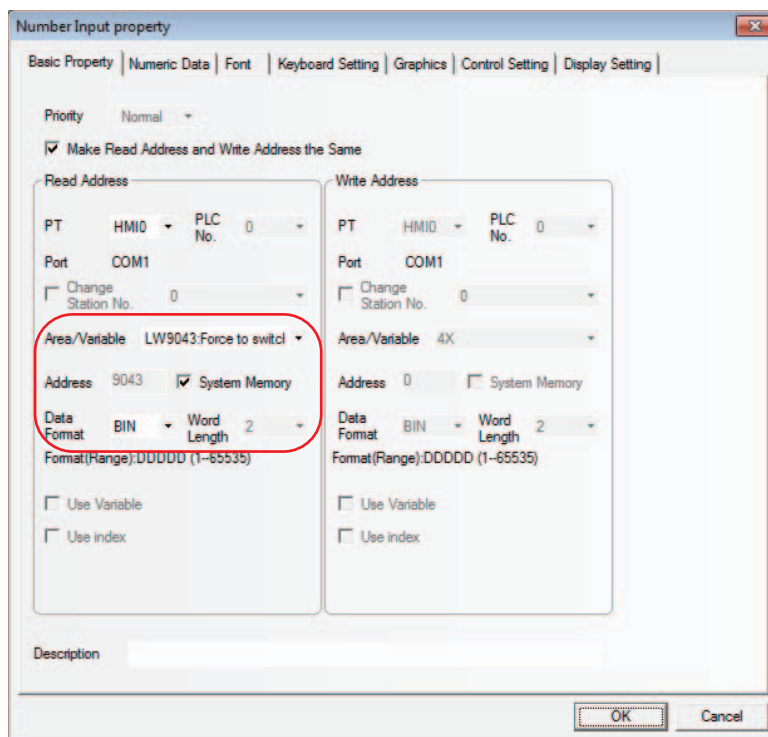

After the Save, Compile and Offline test operations are performed, the state is shown as below. After 1 is input at Switching Level, the current security level will not become 1 because the switching from lower level to higher level is impossible, as the lower right graphics shows.

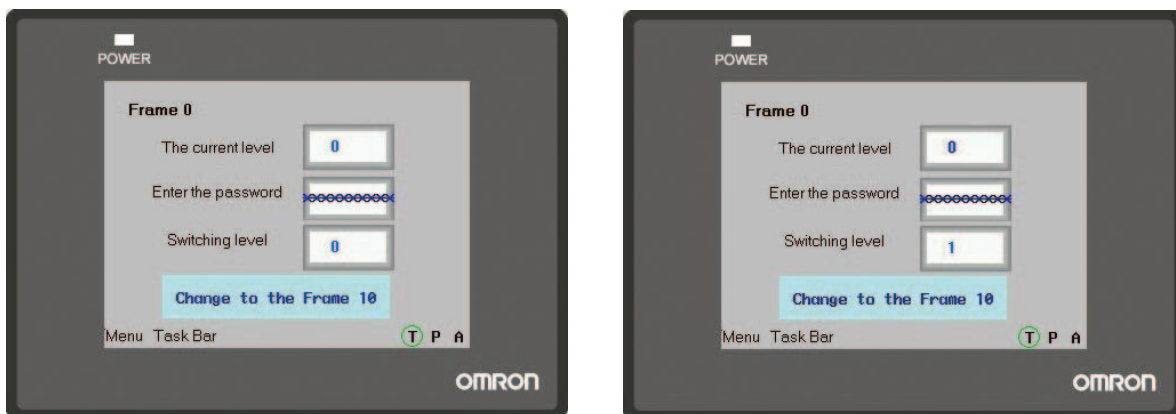

Then input the password 1111 to make the current security level become 1, as the lower left graphics shows. At this time, pressing the Function Key button can realize the switching to Frame 10. But if 0 is input at Switching Level, the current security level will be switched to 0, then the switching to Frame 10 will be impossible, as the lower right graphics shows.

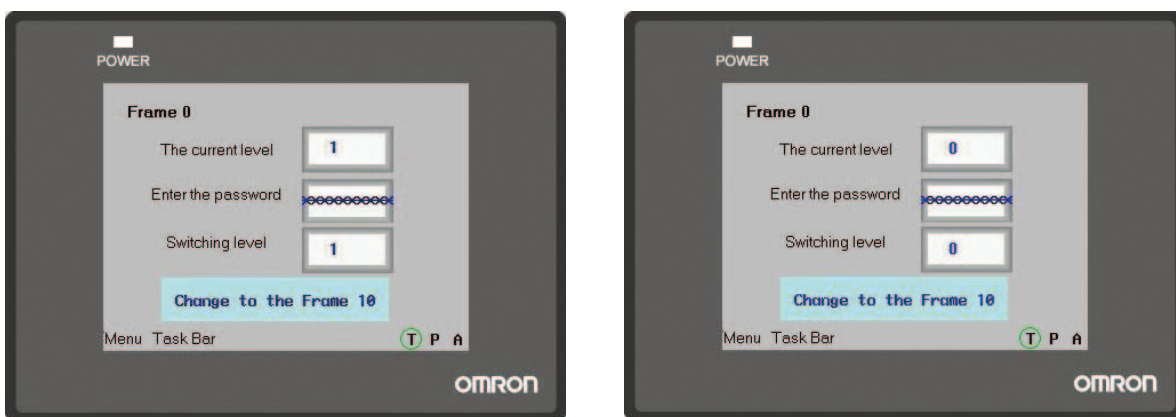

Designing the project by using the level password properly and giving the users permission with different level each allow the security of application enhanced.

● **Switching to the lowest security level when screen closed**

If the security level is set for one screen to realize the following function: the password will be cleared automatically when the screen is closed, and the password needs to be input again when the screen is entered again. The security level will become 0 every time the screen is closed. The settings are as shown below:

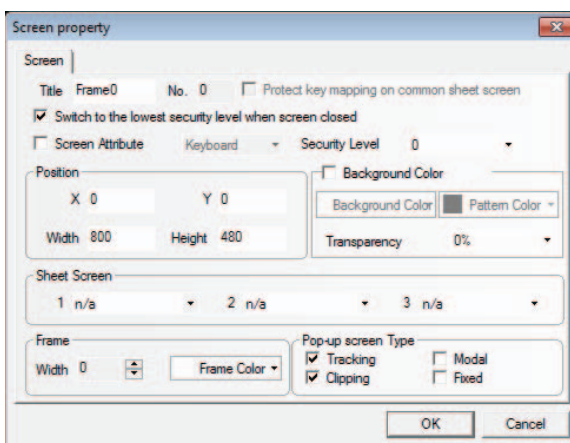

## 3-14 Test

### 3-14-1 Offline test

NB-Designer supports the offline test function. Since the users can review the operation of the screen data on creation without downloading the screen data to PT, the Offline Test can improve efficiency of the screen creating.

Select [Offline test] in [Tools] menu or press  icon, then the following dialog box will pop up:

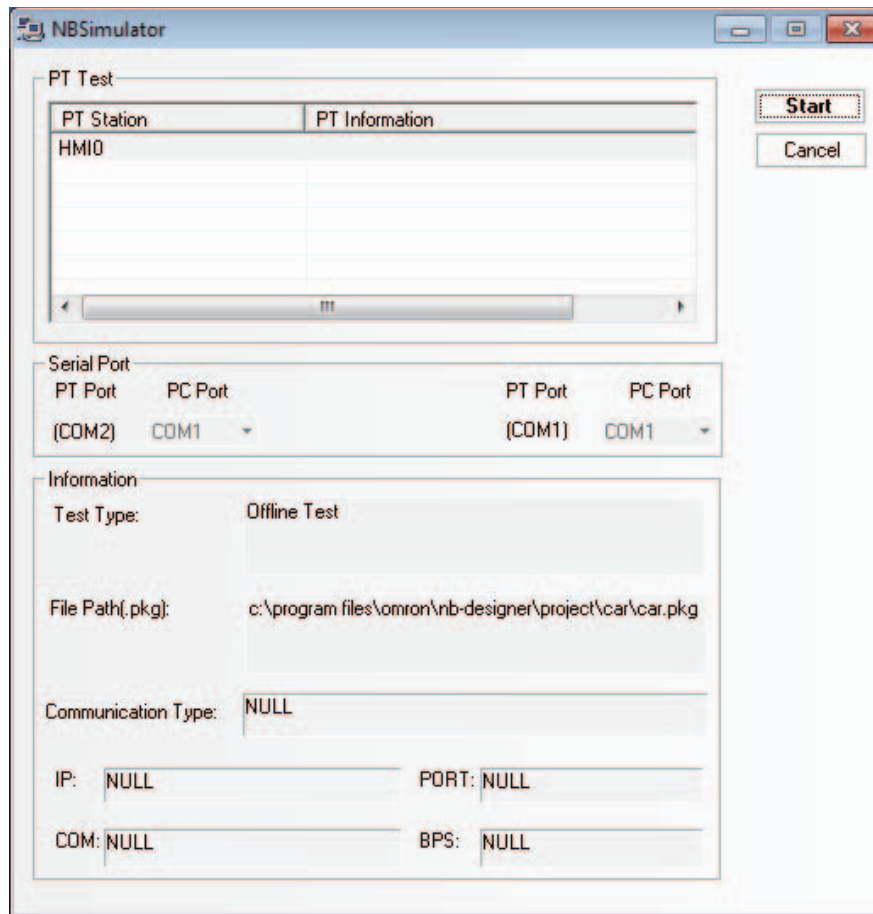

Click the “Start” button after selecting the PT to be simulated, then you will see the offline test window.

### 3-14-2 Direct Online test

NB-Designer supports online test operation. The online test provides the result which is equivalent with the operation executed after downloading to PT and it allows to test directly on PC. Using the online test during debugging can save a lot of time taken by the repeated downloading. The online test is classified into direct online test and indirect online test, which are described as follows:

Direct online test is a test method that directly connects the PLC with the serial port of PC to test the operation. Obtaining the dynamic PLC data without need to connect the PT is its advantage but the communication between the PC and the PLC can support only RS-232 communications. During debugging of PLC with RS-485 port, the adaptor that can convert RS-232 to RS-485/422 must be used.

- Note 1** The test time of direct online test is 15 minutes. When 15 minutes is exceeded, the following prompt information “The test time is exceeded, please perform the test again.” will appear. Then, the window of the test will be closed automatically.
- 2 The direct online test can be done only through the RS-232 communication method.
  - 3 The wiring method of direct online test is the direct connection of the PLC programming cable with the serial port of PC.
  - 4 It does not support the direct connection with the PLC of Ethernet connection type.
  - 5 It does not support the direct online test with the other PLC than that manufactured by OMRON.

After the screen data is compiled, press the  button, then the following dialog box will pop up:

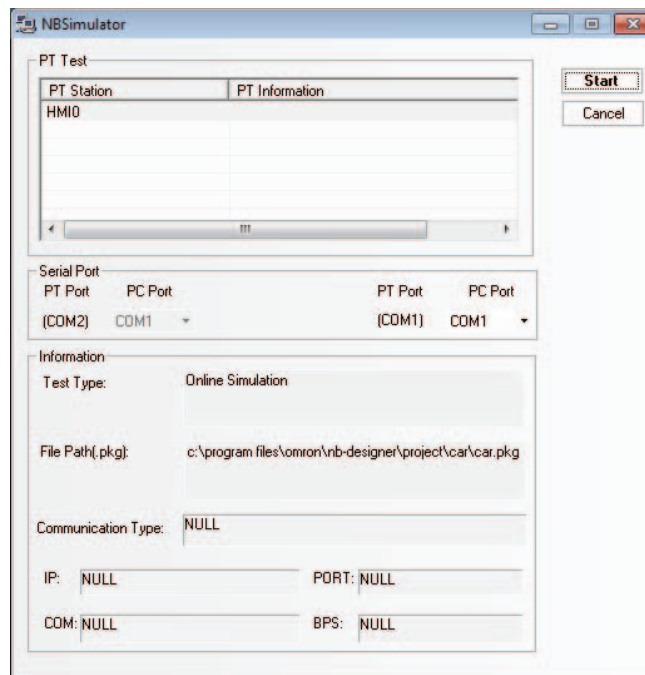

Select the PT No. to be tested and the COM No. of PC to be connected to the PLC, then click the “Start” button to start the direct online test.

### 3-14-3 Indirect Online test

The indirect online test is a method to obtain the data from the PLC through the PT and to test the operations of PT. The indirect online test can obtain the data from the PLC dynamically, and the operating environment is the same as that after the downloading except that the inconvenience of downloading each time is avoided, thus it is quick and convenient, but it can't be used independently without the PT.

After the screen data is compiled, press the  button, then the following dialog box will pop up:

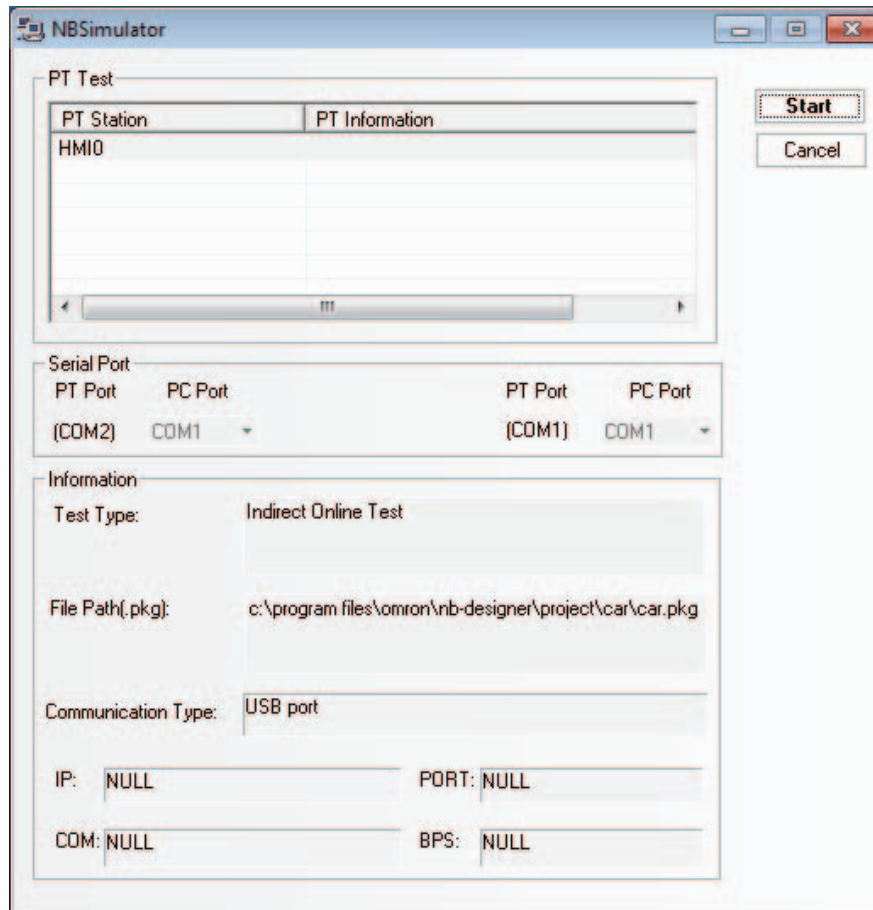

Select the PT to be tested, and click the “Start” button to start the test. NB Unit performs the indirect online test through the USB, Ethernet or serial port.

**Caution** It does not support the indirect online test with the other PLC than that manufactured by OMRON.

## 3-15 Download

### 3-15-1 Transmission Setting

After the project is edited, it can be downloaded to the PT to perform the actual operations. NB-Designer provides 3 download methods, i.e. USB, serial port, and Ethernet (The Ethernet is only applicable to NB□□-TW□1B.). Before the upload and download, you must set the communication parameters firstly. You can select [Tools]-[Transmission Setting] menu to set the communication parameters. After the [Project Option Setting] dialog box pops up, click the [Download Device] drop-down list and select the required download way.

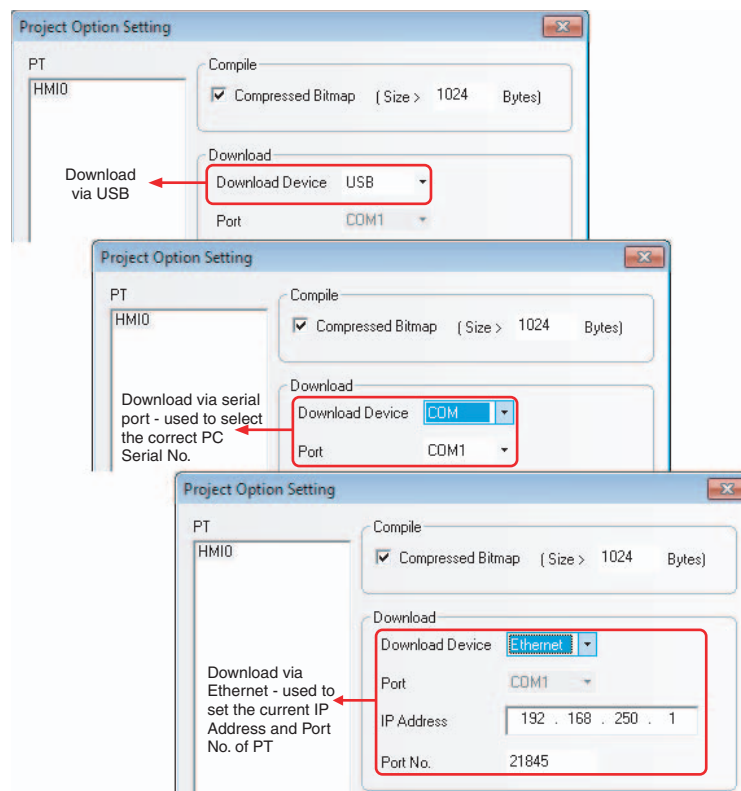

**Note** Data of the NB-S series cannot be downloaded to the regular NB series.

## 1.USB

When using the USB to perform download for the first time, you should install the driver manually. For the installation of the driver, please refer to *2-4 Installation of USB Driver for NB (Page 2-5)* in *NB-Designer Operation*.

When you use USB, you just need to select “USB” as download device and click the “OK” button to start the download.

**Compressed Bitmap:** When this size is larger than the specified size, compress way will be used to perform the compilation and download, thus saving a lot of space. Compressed Bitmap is checked by default.

- Note1** Checking Compressed Bitmap can reduce the size of the edited project.
- 2 Removing the check in the Compressed Bitmap option allows the switching speed of PT faster.
  - 3 In order to ensure the PT with a faster communication speed during the operation, it is recommended not to use too many bitmaps during the project editing.
  - 4 Use less raster fonts as far as possible. The raster fonts occupy the same size as the normal graphics.
  - 5 When the “Enable Printer Function” option is checked in the System Setting Mode, the USB Slave port can be used only for printing function rather than the download function in User Project Mode. For details, refer to *Section 7 PictBridge Printing (Page 7-1)* in *NB-Designer Operation*.

## 2.Serial Port

**Note** The download through the serial port is slower for the edited project being too large, therefore it is not recommended to use the serial port.

## 3.Ethernet

### ● Precautions for download through Ethernet and setting methods of IP address:

The IP address of PC and that of PT should locate in the same network segment with the first 3 parts being same and the last part not being overlapped. If the LAN is used, the IP address can't be modified to prevent the conflict with the other IP addresses in the network.

First, set the network IP address in the “Control Panel” for Windows to the same network segment as that for PT Unit. The IP address of PT Unit can be checked from the PT in the System Setting Mode (Refer to *3-1 Display Method of System Setting Mode (Page 3-2)* in *PT Setup*).

Then, make various settings in the Project Option Setting dialog box:

In the NB-Designer, select “Ethernet” from the Download Device option in Project Option Setting dialog box after clicking [Transmission Setting] option  in the [Tools] menu, and then set the IP address to be same as that of PT Unit. At that time, the project created in NB-Designer can be downloaded into the PT.

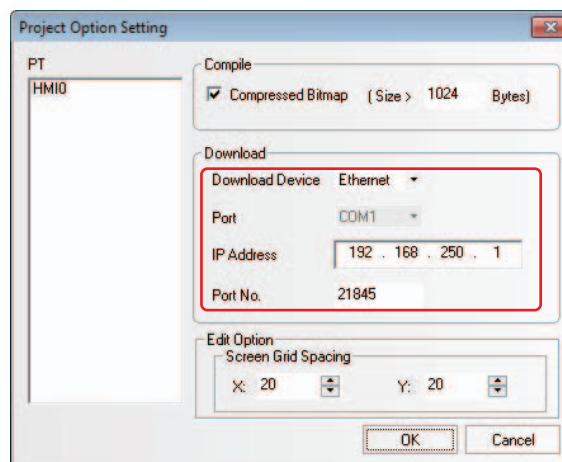

Changing Network Setting of PT Unit:

After confirming the download function, set the IP option in the [PT] tab in the [PT Property] dialog box to the IP address and others, and then download it into PT after Compile operation is performed. At that time, the IP address of PT is same as that set in the project. (If download through Ethernet is performed again, please specify the modified IP address and port number in the Project Option Setting dialog box.)

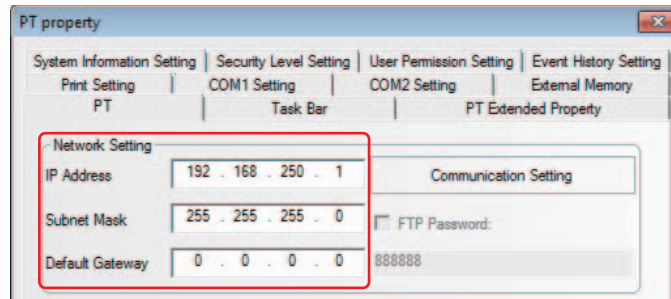

- **Setting IP address in System Setting Mode:**

For more details of Setting IP address in System Setting Mode, refer to *3-2 Functions of System Setting Mode (Page 3-3) in PT Setup*.

- **Setting IP address by using [Set IP Address/Port] in NBManager:**

For more details of Setting IP address by using [Set IP Address/Port] in NBManager, refer to *4-2-1 Communication Setting (Page 4-3) in NB-Designer Operation*.

After the settings mentioned above, click  icon to download the screen data.

The download method is shown as below:

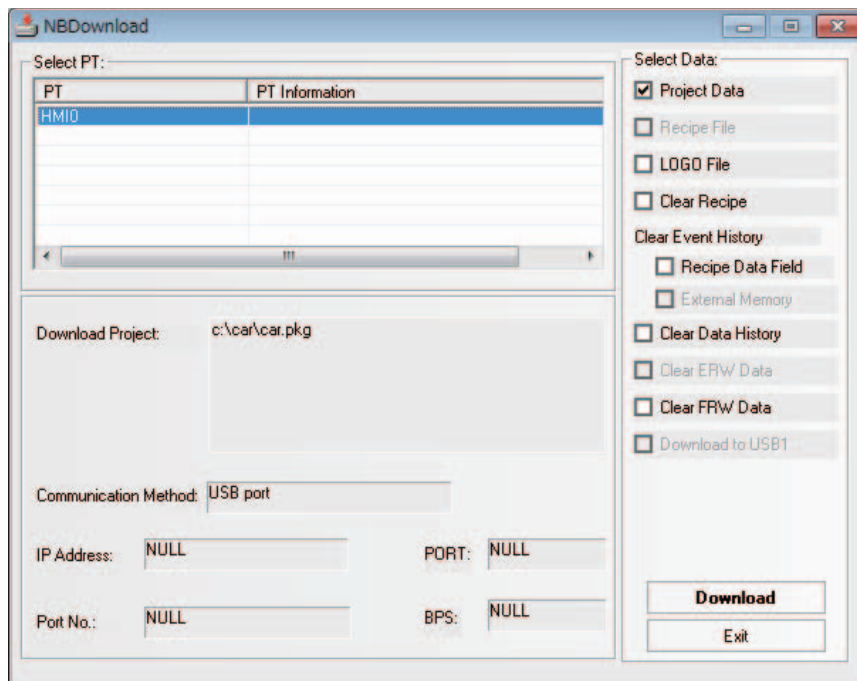



### 3-15-2 Download via USB Memory

This function cannot be used on the NB-S Series.

### 3-15-3 Specification of Downloading Contents

In the [NBDownload] dialog box, check the required contents in the [Select Section] option to download the required files.

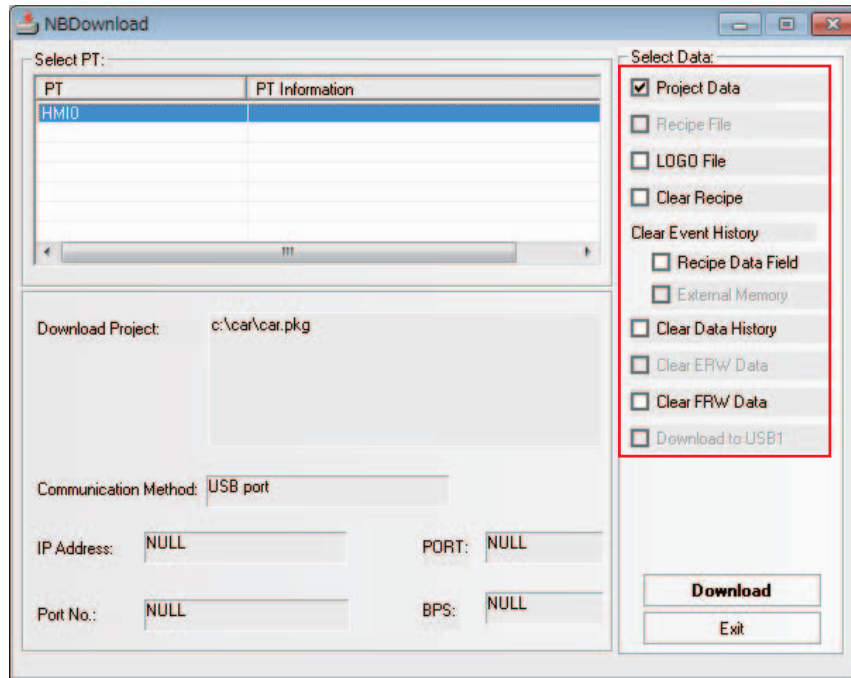



**Data File:** Refers to the data information of all the components created by the user in PT screen. Only after this option is checked, the downloaded project can work normally.

**LOGO File:** Download the initial screen (LOGO screen) displayed when starting PT. If the update of the LOGO screen is needed, check the [LOGO file] check box and click [Download] to download the screen.

### ● Editing LOGO Screen

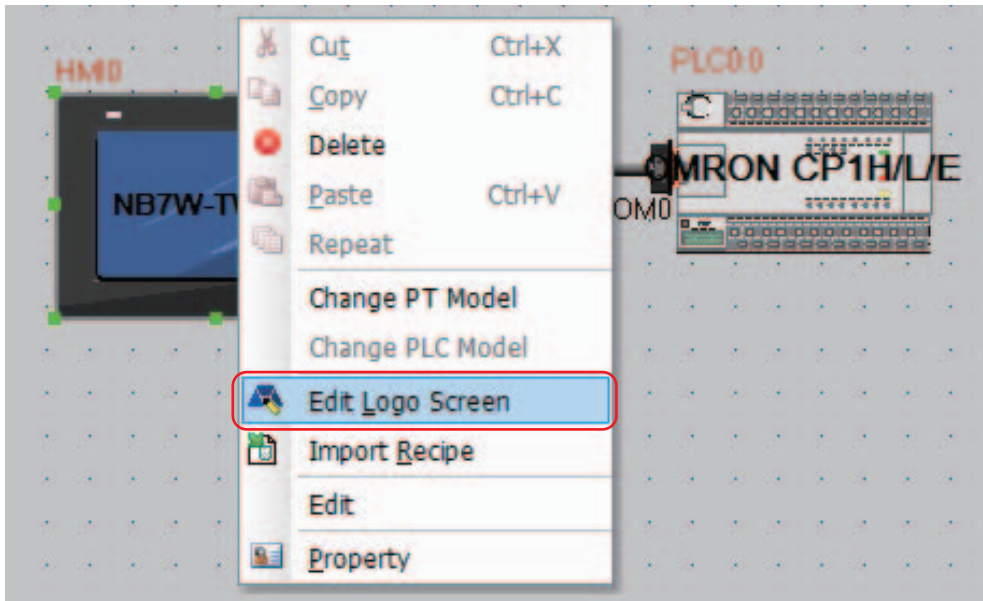
Press the  icon in the toolbar, or select and click the PT in the Project Work Space to display the Edit Window as below.



You can apply the optional LOGO screen. And if you click the  icon in the toolbar, the following dialog box will appear:

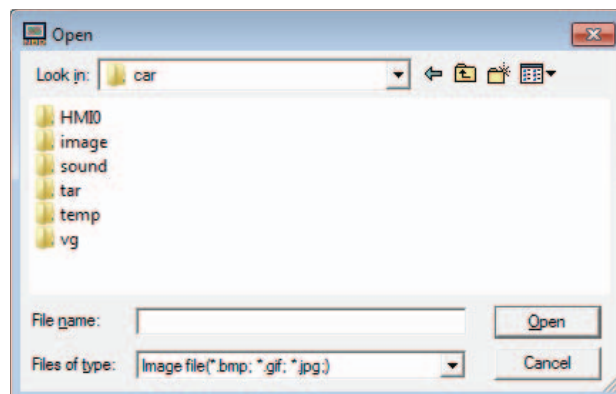

Find the required LOGO graphic, and click it to open it.

After the compilation, check “LOGO File” and then click the “Download” button.

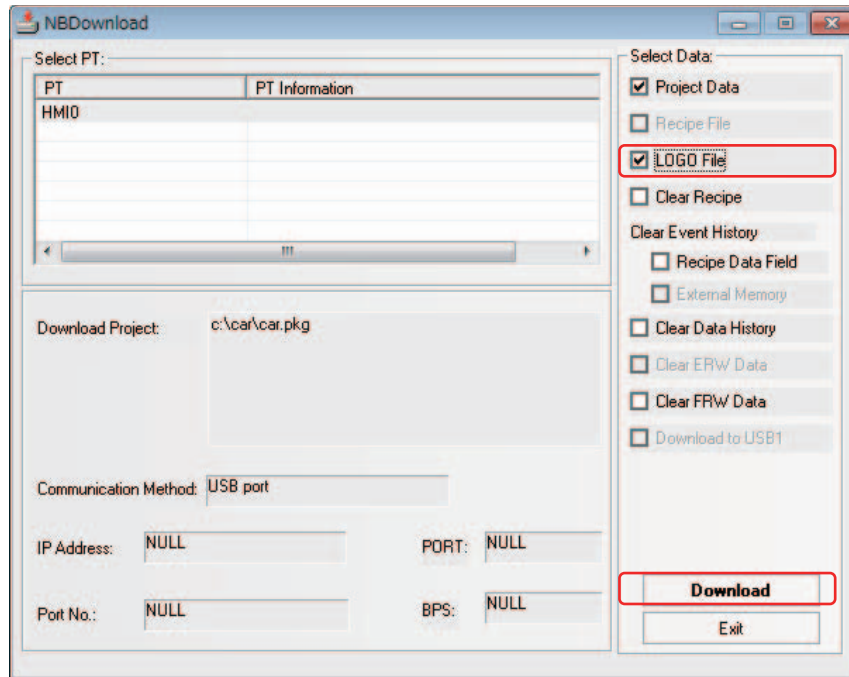

After the download is completed, “Download succeed” will be displayed.

● Download Window

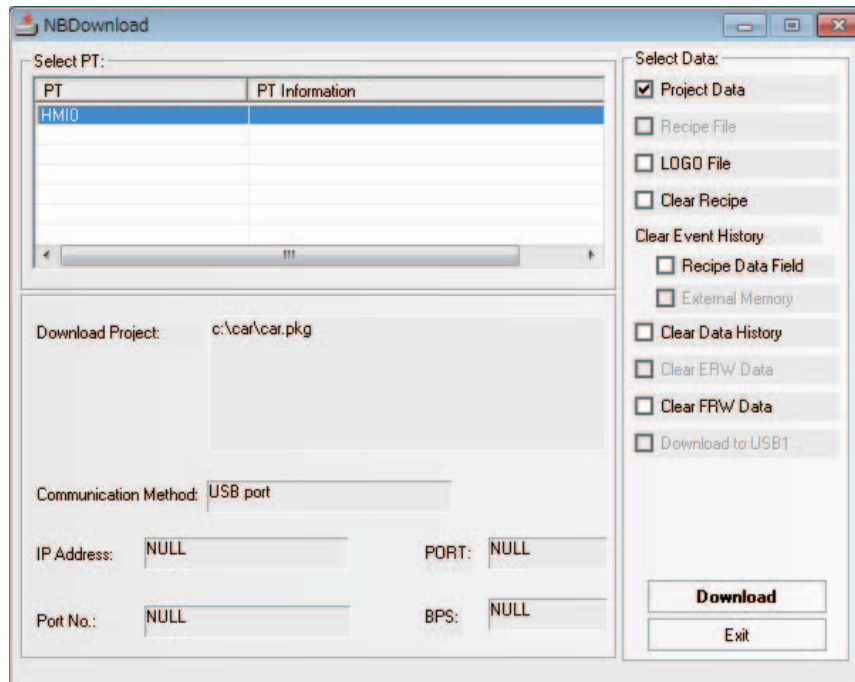

Each function is described as follows:

- 1** Data File: It is used to download the current project.
- 2** Recipe File: The NB-S series does not support this function.
- 3** LOGO File: Download the graphics used for LOGO screen. When the graphic is modified in [LOGO Screen Edit], you need to check in the [LOGO file] option to download the modified LOGO file to the PT.
- 4** Clear Recipe: If this check box is checked, the Recipe memory will be cleared to 0.
- 5** Clear Event History: Clears the saved events.
- 6** Clear Data History: Clears the saved sampling data.
- 7** Clear ERW Data: The NB-S series does not support this function.
- 8** Clear FRW Data: Clears the data in the FRW.
- 9** Download to USB1: The NB-S series does not support this function.

You can also select whether to clear the recipe data, FRW data, ERW data, data history, or event history by using the Download Operate in NBManager.

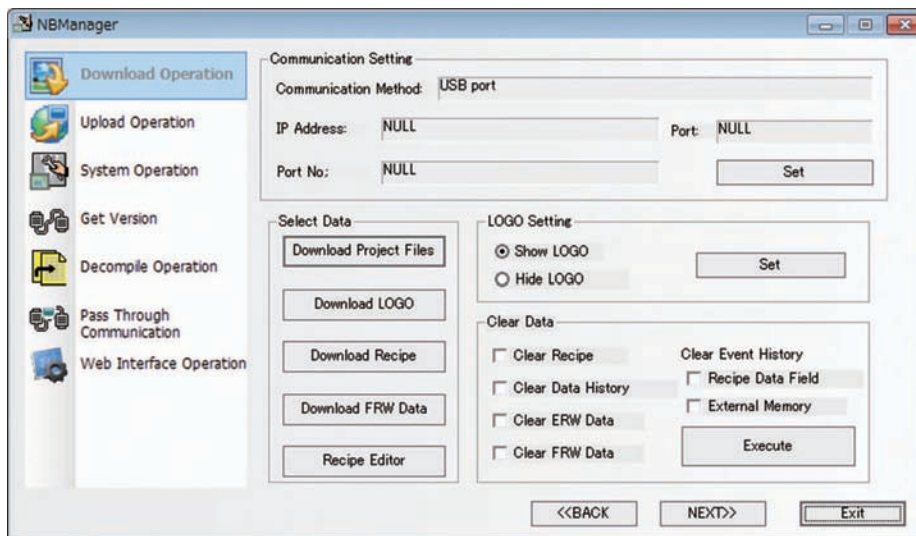

**Note** Because the NB-S series does not support USB external memory, some of the above functions cannot be used.



#### Additional Information

To download the screen data of a different version, download the Kernel from NB Manger as required.

## 3-16 Other Functions

### 1 Editing component function

For the Copy and Paste operations, if a component is copied in the same screen, the copied component will be placed in the position deviated 10-pixel away the original position. If the component is copied in different screen, the copied component will be placed in the position of the original position.

If multiple components are operated by the functions such as “Arrange Width”, “Arrange Height”, and “Arrange Size”, the specific operation process is as follows: Select one component as the reference, then perform “Width”, “Height”, or “Size” modifications. (If you use the “Shift” key to select, then the component firstly selected should be as the reference, while the component at the leftmost should be used as the reference during the selection made by dragging the mouse. The selected mark for the reference is indicated by the solid rectangle, while the selected mark for the other components is indicated by the hollow rectangle.)

### 2 Proportionally zoom multiple components simultaneously

When the multiple components in the editing screen are selected together, selected area will appear, and the user resize the multiple components simultaneously dragging by mouse each point on the corners.

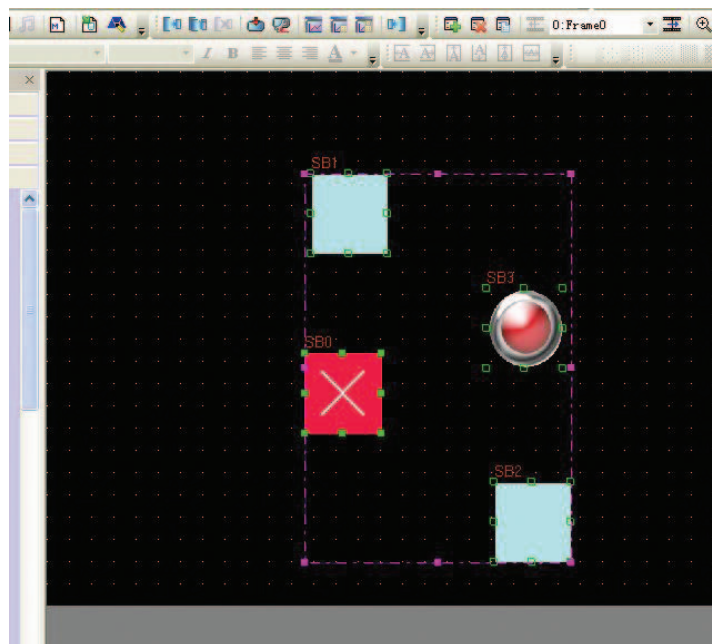

Resize the multiple components simultaneously dragging by mouse each point on the corners. Above, the selected area is pink.

### 3 Lock Component

NB-Designer provides one function of “Lock Position” as shown below. Right-click the component and select the “Lock Position”, and the effect is as shown below.

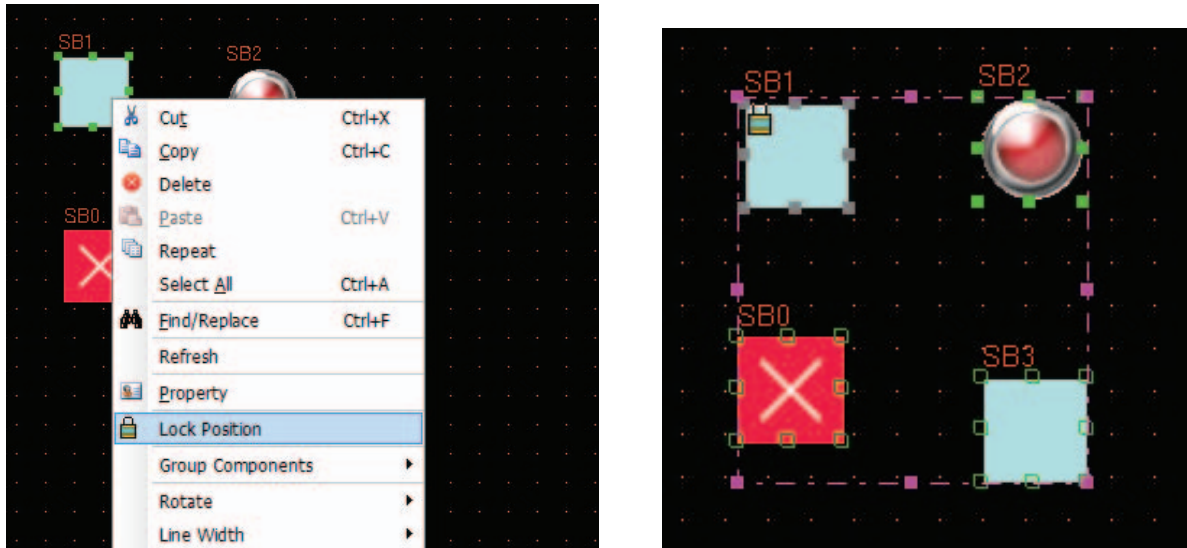

When the user selects the multiple components including the locked component to perform the operation of movement etc, this locked component will have no response to this operation. Please note that there will be one lock-shape mark on its original icon, as shown above.

### 4 Multiple Copy of Component

Single Copy: When the user selects one component to perform single copy, he just needs to click the component while pressing the Ctrl key, which is equivalent to the operation of “Copy + Paste”.

Repeat: It is intended for the multiple copy of a certain component, and the software can automatically increase or decrease the component address and set the interval after the component copy operation. Right-click the component to be copied, and select “Repeat” from the Context menu, then the following dialog box will pop up. The user can make settings according to the requirement.

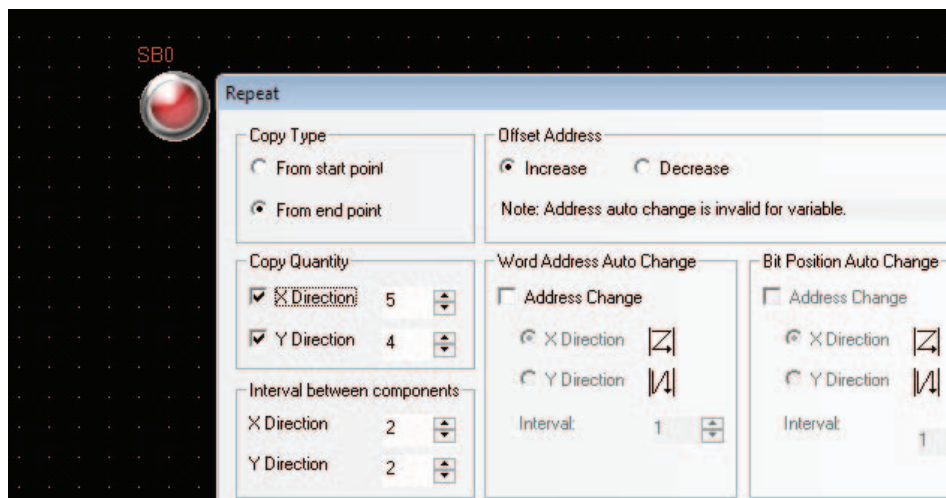



The effect of repeat is shown as above.

### 5 Find/Replace

Select [Find/Replace] in the drop-down menu of the [Edit] menu or press the “Find/Replace” icon, then the following dialog box will pop up.

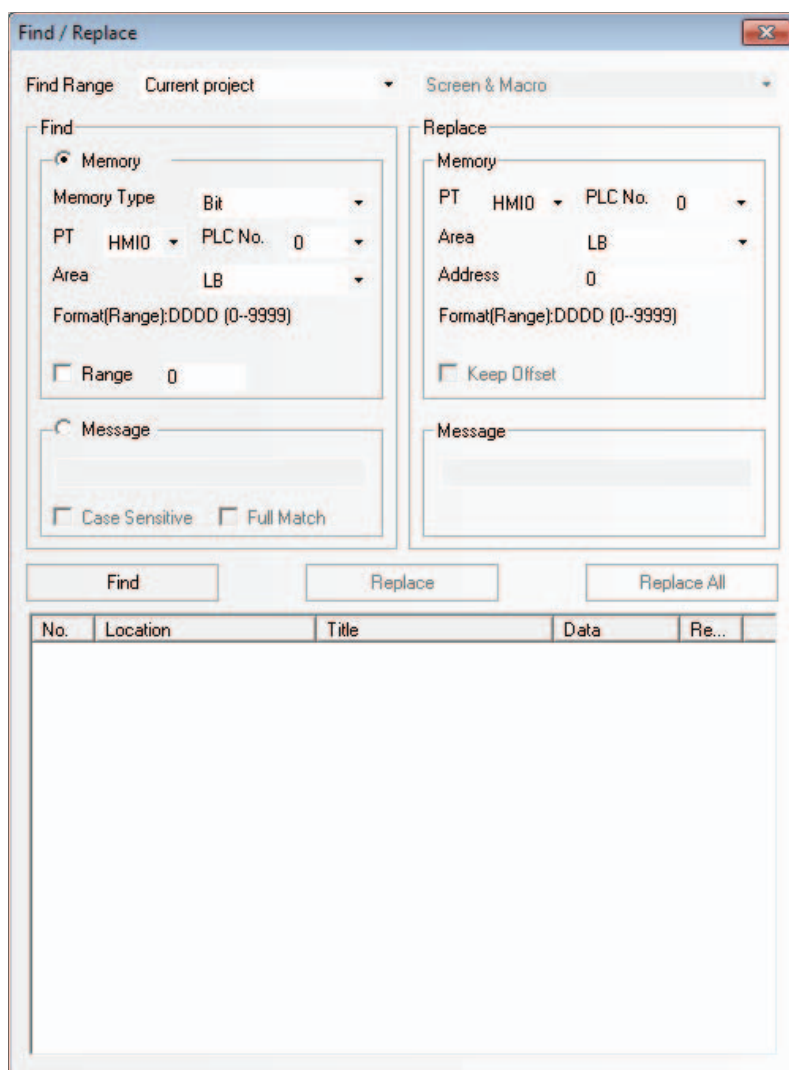

### ● Find Range

Refers to the content of the edit screen in NB-Designer to be searched, and it is classified into 4 kinds, as shown below.

Descriptions of Find Range				
Find Range	Current Project	All the Screens, Macros and background database in PT will be searched.		
	Background Database	Only the background components such as Event Setting, Alarm Setting and Data Log etc. will be searched.		
	All PT	Screens and Macros	All the Screens and Macros in the current project will be searched.	
		All Screens	All the Screens in the current project will be searched.	
		All Macros	All the Macros in the current project will be searched.	
	Current PT	Screens and Macros	All the Screens and Macros in the selected PT will be researched.	
		All Screens	All the components in all the Screens in the selected PT will be searched.	
		Current Screens	All the components in the current Screen in the selected PT will be searched.	
		All Macros	Only all Macro in the current PT will be searched.	

### ● Find

Descriptions of Find Type		
memory	memory Type	It means to find the device with Bit type or Word type.
	Area/Variable	It represents the device type and device address in the controller where the search is performed. Checking "Range" means the search will be performed in the set range of address.
Message	Not checking "Match Case" and "Full Match" means the judgment of the case of the characters and the consistency in the whole text will not be done during the search.	
	Case Sensitive	It means the match of the case of the characters in the text to be searched is required.
	Full Match	It means the match of the text to be searched in the whole text is required.

### ● Replace

After this option is set, the area and address found according to the set conditions will be replaced by the specified area and address.

"Keep Offset" in the Replace part will take effect once the "Range" in Find part is checked. If "Keep Offset" is not checked, the replace address is the same; while if "Keep Offset" is checked, the replace address is the consecutive address which will automatically deviate by making the set replace address as the start address.

When the above parameters are set, if the "Find" button in the dialog box is clicked, the search of address meeting the condition will be performed the screen locating in the Find Range. If the component is found, then No., Location, Name and Data will be displayed in the bottom white box. When the components displayed in the search result is double-clicked, the window will be switched to the screen placed the matched components and Property dialog box will be displayed.

Clicking "Replace" or "Replace All" means the found component meeting the conditions will be replaced by the component with the address type and address set in the "Replace" part.

If the "Replace All" dialog box shown as below is clicked, the Write/Read Address of all component which are specified to "MW0" in the current project, are replaced to "MW0".



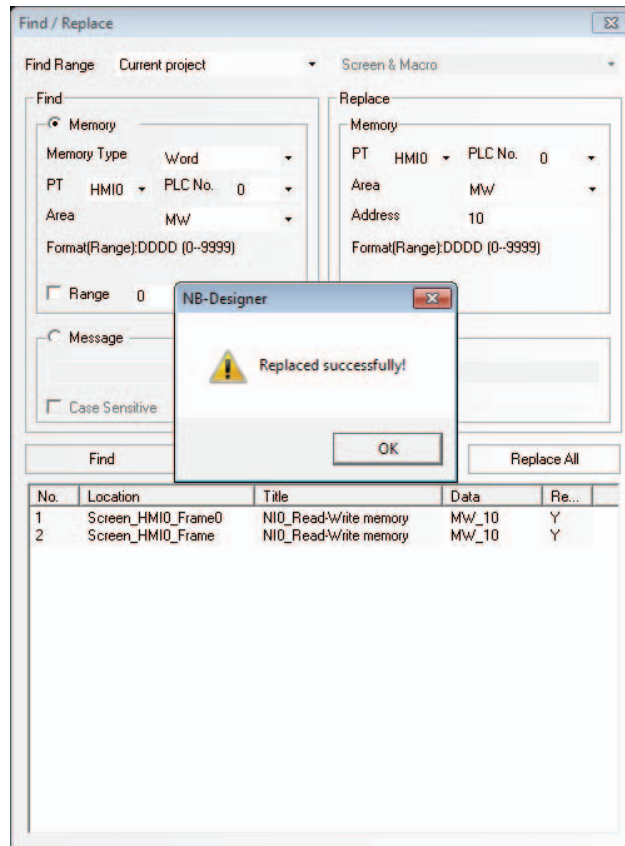

## 6 Copy Text Font Settings

To change font settings of text parts where the Text Library is used, select [Edit] - [Copy text font settings] in the Menu.

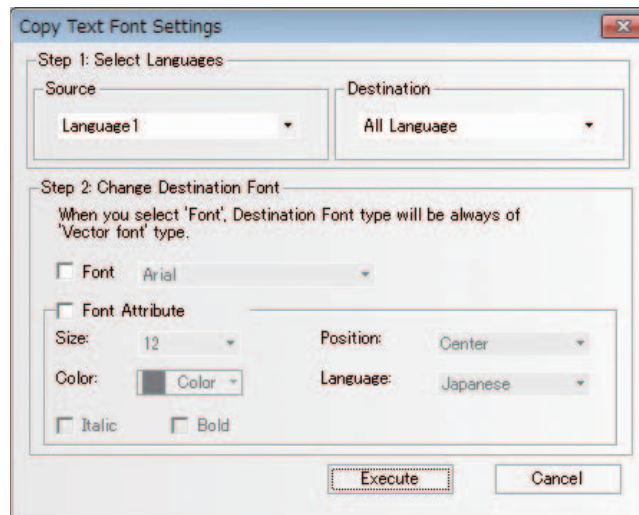

(1) Select a language you copy font setting.

Set the languages in [Source] and [Destination].

(2) Click Execute.

The settings will be copied from [Source] Language to [Destination] Language. It may take a long time.

Example) The following project has Text 1 and Text 2. Language 1 is set in [Source], and Language 2 is set in [Destination].

	Before		After	
Text 1	Language 1 Font	DFNB-EN	Language 1 Font	DFNB-EN
	Language 2 Font	DFNB-JP	Language 2 Font	DFNB-EN
Text 2	Language 1 Font	DFNB-JP	Language 1 Font	DFNB-JP
	Language 2 Font	DFNB-EN	Language 2 Font	DFNB-JP

As for Text 1, DFNB-EN set as Language 1 will be copied to Language 2. Thus, both Language 1 and Language 2 will be DFNB-EN.

As for Text 2, DFNB-JP set as Language 1 will be copied to Language 2. Thus, both Language 1 and Language 2 will be DFNB-JP.

The font attributes (Size, Position, Color, Italic, and Bold) will be copied as well.



**Additional Information**

To change the settings regardless of Source settings, execute [Change Destination Font].

When check box in [Change Destination Font] is checked, after settings are copied, the specified settings are overwritten.

To designate overwriting items, check the [Font] box and the [Font attribute] box.

Example) The following project has Text 1 and Text 2. The [Font] box is checked and DFHEI5 is set as the font.

	Before		After	
Text 1	Language 1 Font	DFNB-EN	Language 1 Font	DFNB-EN
	Language 2 Font	DFNB-JP	Language 2 Font	DFHEI5
Text 2	Language 1 Font	DFNB-JP	Language 1 Font	DFNB-JP
	Language 2 Font	DFNB-EN	Language 2 Font	DFHEI5

First, Language 1 set as Text 1 and Text 2 will be copied to Language 2. Next, Language 2 Font set in [Destination] will be overwritten to the designated font. As a result, Language 2 Font on both Text 1 and Text 2 will be DFHEI5.

**Note** Copying and overwriting will not be performed if the part becomes larger than the screen size due to the change in the font size. Please specify an appropriate size.



However, if the overlaid components include the function key of changing screen, the screen is changed so that the other component behind the function key by are also unable to be operated by the function. Therefore, the function key of the changing screen should be arranged at the behind of all the component.

1 <sup>st</sup> layer	<b>Y0</b>	First, execute the command Y0
2 <sup>nd</sup> layer	<b>Y1</b>	Command execution Y1
3 <sup>rd</sup> layer	<b>Y2</b>	Change Screen
4 <sup>th</sup> layer	<b>Y3</b>	
5 <sup>th</sup> layer	<b>Y4</b>	Ignore all
6 <sup>th</sup> layer	<b>Y5</b>	

## 9 Pinyin Input Method

NB-Designer can be used to input common Chinese characters. Only Text Input component and Not Book component support Pinyin Input method.

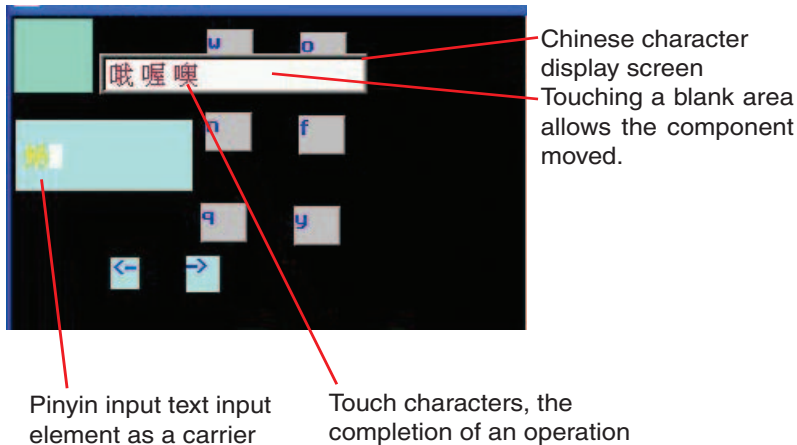

The memory related to the Pinyin input method is described as follows:

LB9100: Used for input method switching,

i.e. LB9100 = 1 for Pinyin input method, and LB9100 = 0 for English input method.

LW9150: Used for PageUp and PageDown operation to Chinese characters display screen.

Due to that 8 Chinese characters (max.) can be displayed in one Chinese character display screen, the PageUp and PageDown functions are needed to display more Chinese characters.

The value of LW9150 is the No. of Chinese characters displayed in the current Chinese character display screen. For example, it is assumed that the number of Chinese homophones of Pinyin "wo" is M, when the value of LW9150 is N, then the N<sup>th</sup> Chinese character and the follow-up characters will be displayed in the Chinese character display screen.

LW9152 to LW9167: Used to display the Pinyin characters input currently.

### ● Usage:

Firstly, switch to the Pinyin input method through LB9100 when the input is triggered by the Text Input component (or Note Book component), and input the Pinyin characters (displayed in LW9152 to LW9167 later) correctly, and touch the corresponding Chinese character from the several Chinese characters displayed on the Chinese character display screen, then the process of inputting Chinese character is completed.

Triggering the blank area of the Chinese character display screen can realize the movement of this screen, which is similar to the screen console of the function key.

If the Pinyin needs to be modified during the input, the function keys of “Back Space” or “Clear” can be used to realize this operation.

“Back Space” and “Clear” functions of Function Key is prior to the input Pinyin characters, i.e. when the Pinyin characters are input currently, the object operated by the “Back Space” and “Clear” function is the Pinyin characters instead of the other characters in the text input area.

**Note** When the font size is 8, 24, 48, 72 or 96, the Pinyin input method is invalid.

## 10 LSB Type

LSB type is applicable to the Command Button component, Word Lamp component, and Word Neon Lamp component. If the Bit Button component is operated, the text string to display in neon lamp and others can be controlled.

LSB is the acronym of Least Significant Bit. This encoding type first converts the data in the buffer to binary data, and then determines the current state of the component based on the number of consecutive “0” at the least significant bits of the binary data.

[Example] Take an example of the data with word address to be displayed:

Hexadecimal	Decimal	Binary	Number of consecutive “0” at least significant bits	State Number
0000	0	0000 0000 0000 0000	16	16
0001	1	0000 0000 0000 0001	0	0
0002	2	0000 0000 0000 0010	1	1
0003	3	0000 0000 0000 0011	0	0
0004	4	0000 0000 0000 0100	2	2
0005	5	0000 0000 0000 0101	0	0
0006	6	0000 0000 0000 0110	1	1
0007	7	0000 0000 0000 0111	0	0
0008	8	0000 0000 0000 1000	3	3
...	...	...	...	...
0010	16	0000 0000 0001 0000	4	4
0020	32	0000 0000 0010 0000	5	5
0040	64	0000 0000 0100 0000	6	6
0080	128	0000 0000 1000 0000	7	7
0100	256	0000 0001 0000 0000	8	8
0200	512	0000 0010 0000 0000	9	9
0400	1024	0000 0100 0000 0000	10	10
0800	2048	0000 1000 0000 0000	11	11
1000	4096	0001 0000 0000 0000	12	12
2000	8192	0010 0000 0000 0000	13	13
4000	16384	0100 0000 0000 0000	14	14
8000	32768	1000 0000 0000 0000	15	15
...	...	...	...	...

## 11 Disconnected Host can be Masked of the Station No.

The disconnected Host can be masked with the communication error. If the settings are valid, all the “PLC No Response” for the device behind can be masked.

## 12 Data Log, XY Graph and Oscillograph

Data Log/XY Graph/Oscillograph components have extended Properties, as shown below:

- Border, Grid and Background Color etc.
- Display Type of sampling point.
- Sampling cycle can use the Indirect Reference.
- The style of XY Graph are scatter plot and shaded plot.
- Sampling points can use the Indirect Reference.
- The Data Log can be saved to the PT.

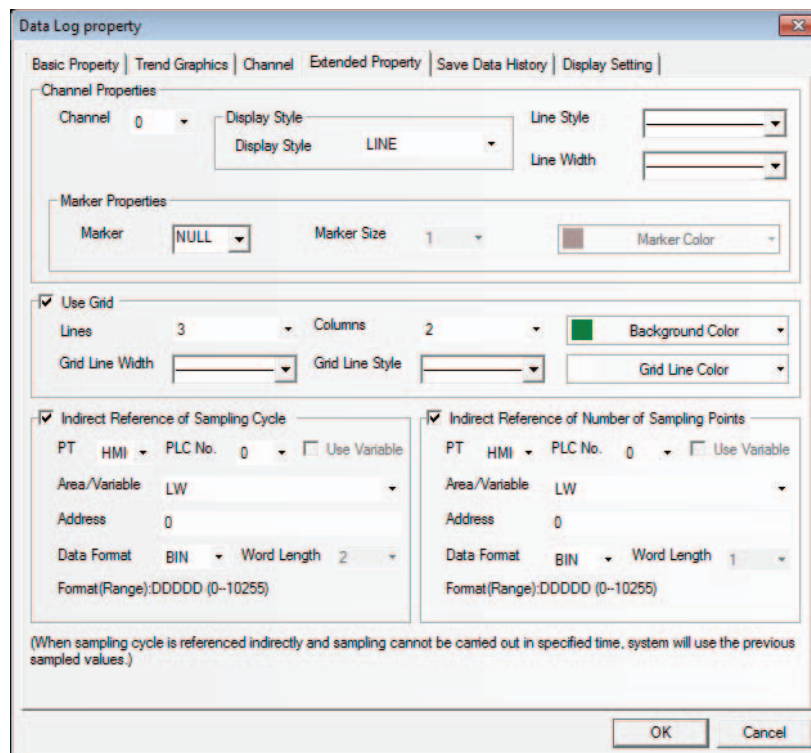

When the sampling cycle and the sampling points are specified indirectly, if the value of the reference address cannot be obtained, the value obtained previously can be used.

The extended properties of the data log are as follows:

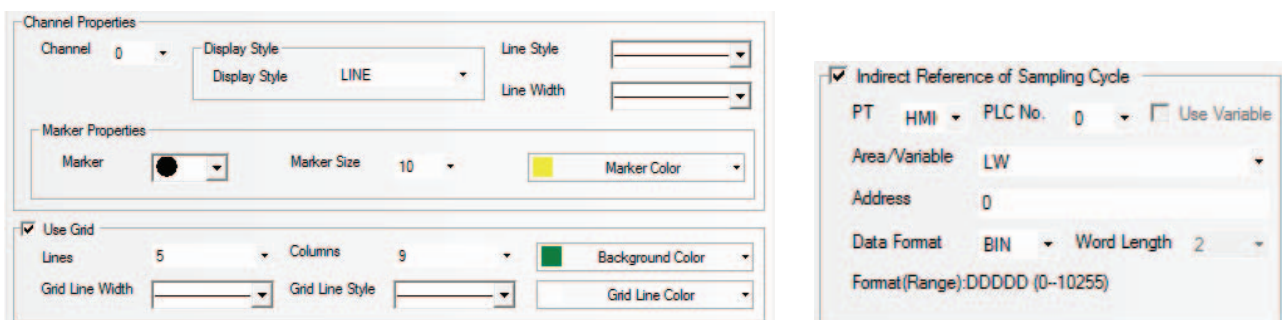

The effect of the screen is as shown below:

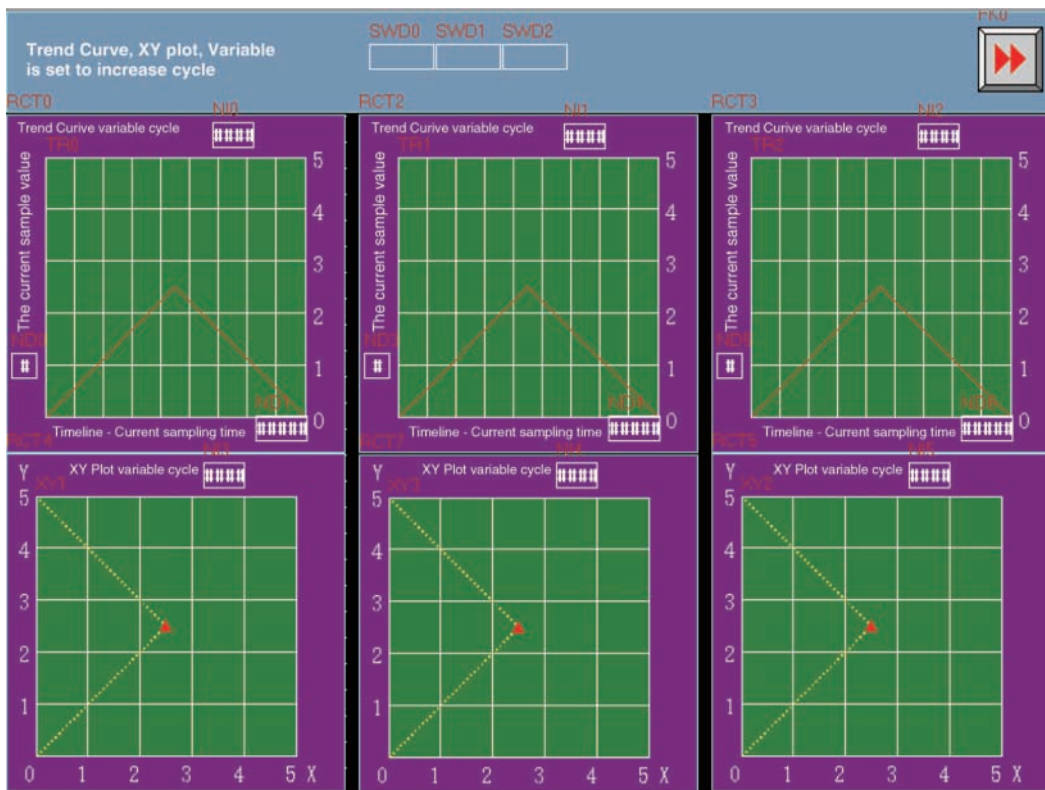
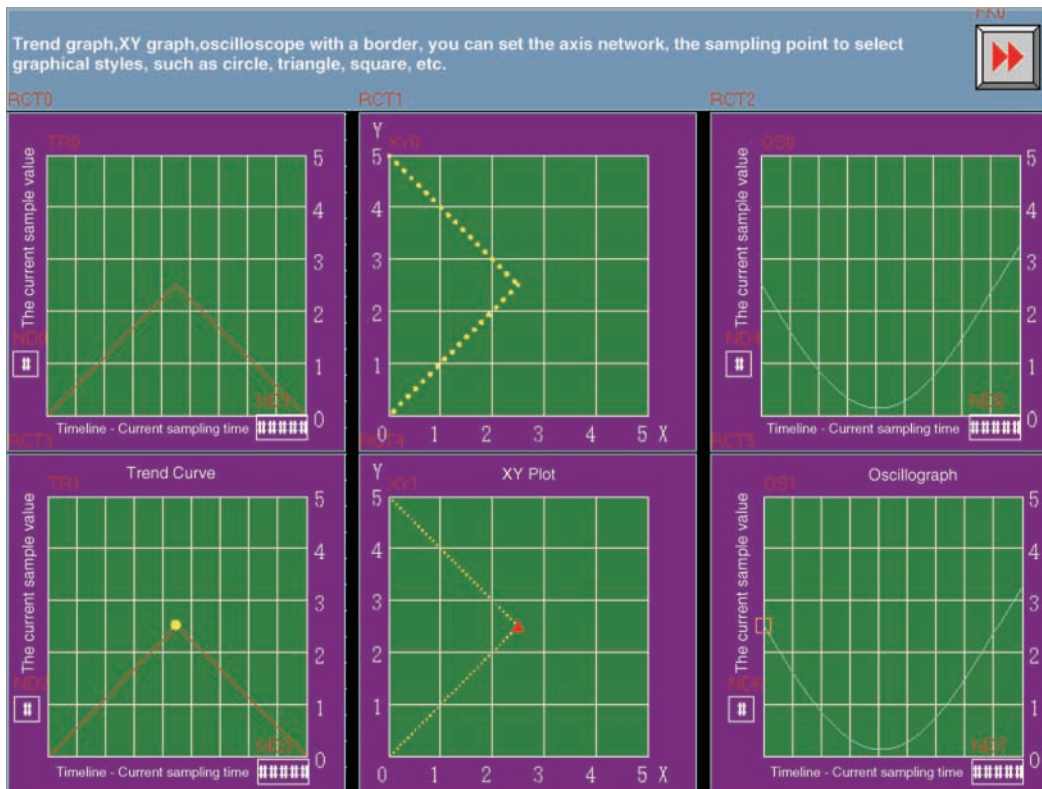

The effect of test is as shown below:

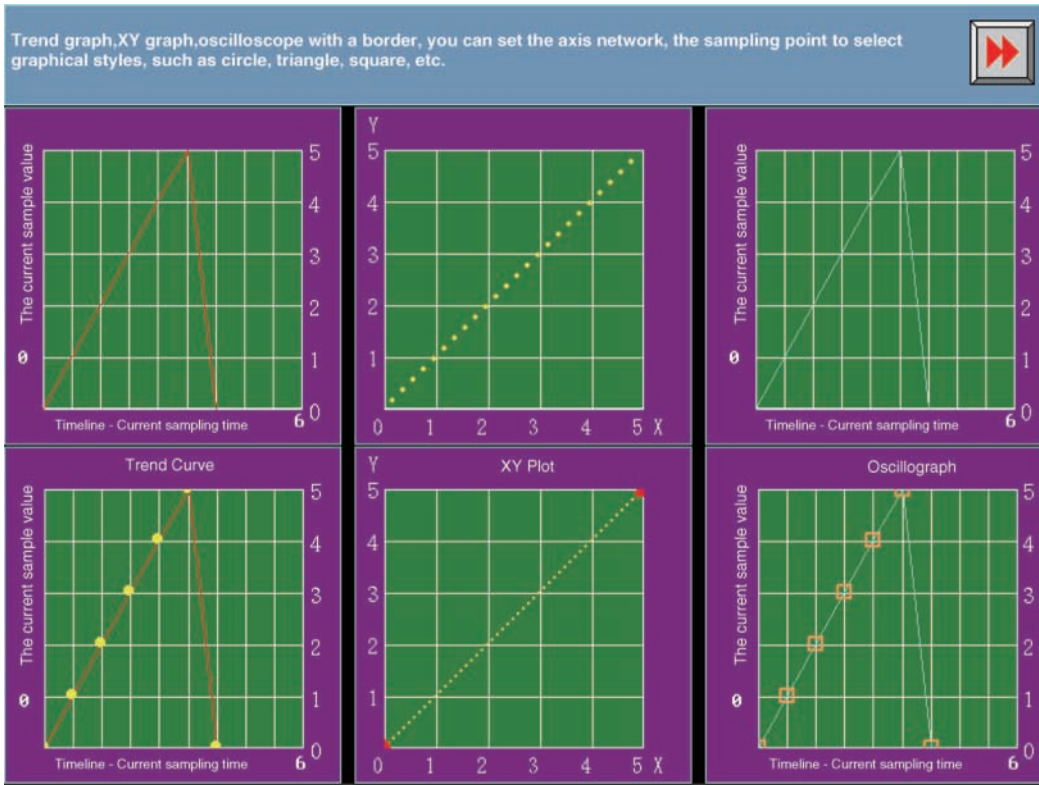



## 13 Use Input Order

The Number Input component, Text Input component and Note Book component have this function.

Using the [Use Input Order] allows continuous input to Number Input component, Text Input component, and Note Book component. Even if the “Enter” button is pressed, the keyboard will not be closed automatically and will be kept to be opened and the cursor using [Use Input Order] keeps moving among the components until the screen is closed by pressing “X” in the top of the keyboard.

[Group] is used to classify the multi-group of components needing consecutive inputs. The components with the same group number belong to the same group, and the cursor will be cyclic in the same group of components. When the “Enter” is pressed, the keyboard will not be closed automatically, but will always be displayed in the screen until the close button “X” in the keyboard is clicked.

Setting of [Use Input Order]

Go to the [Keyboard Setting] Property tabs for the Number Input component, Text Input component and Note Book component respectively, and check the [Use Input Order].

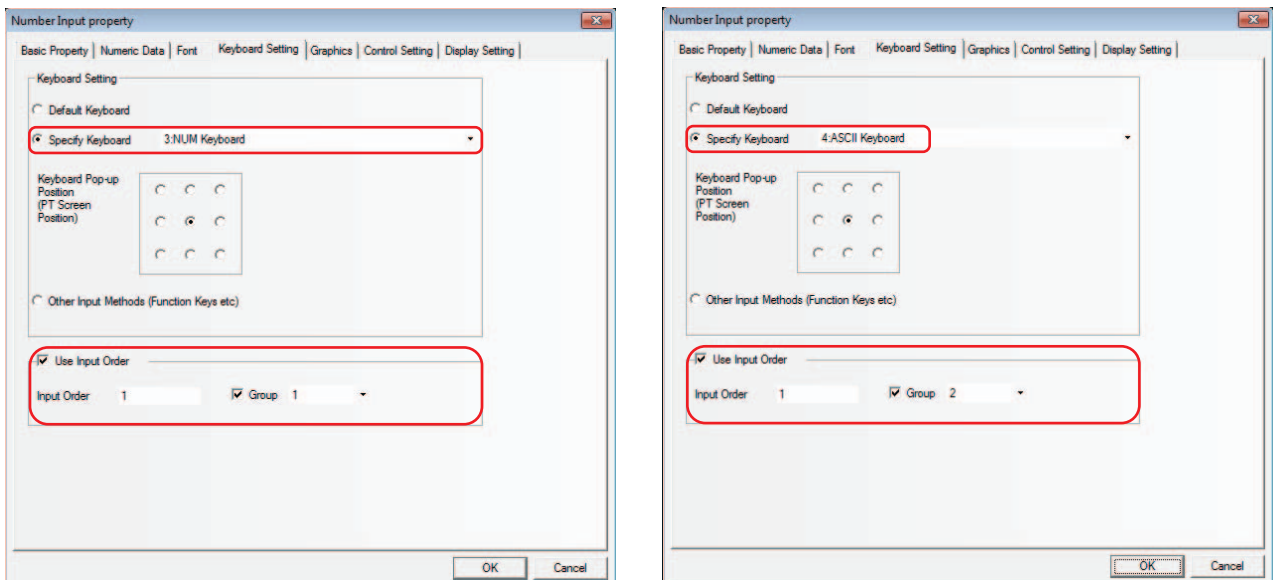

## 14 [Import/Export] of Background Component

The background component including [Variable Table], [Text Library], [Alarm Setting], [Event Setting] and [PLC Control] has the function of importing or exporting the file in .csv format. This function is convenient to edit the related contents through the csv directly.

### Note:

Please pay attention to the following points when saving the file in CSV format after it is edited.

- (a) When the csv file is saved in Excel, click [Save] and select [Yes] as shown below:

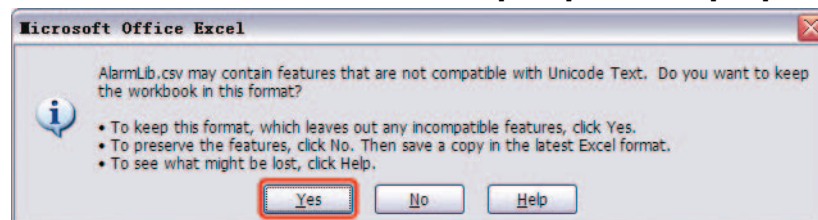

- (b) After selecting [File] - [Exit] in the menu, a dialog box as follows will be displayed and select [Yes].

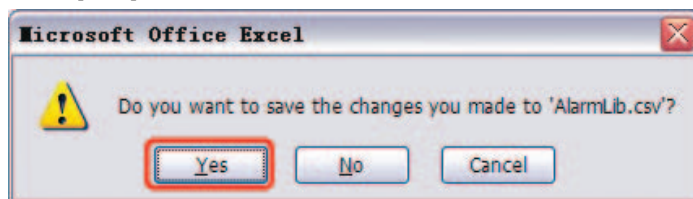

- (c) [Unicode Text(\*.txt)] must be selected from [Save as type].

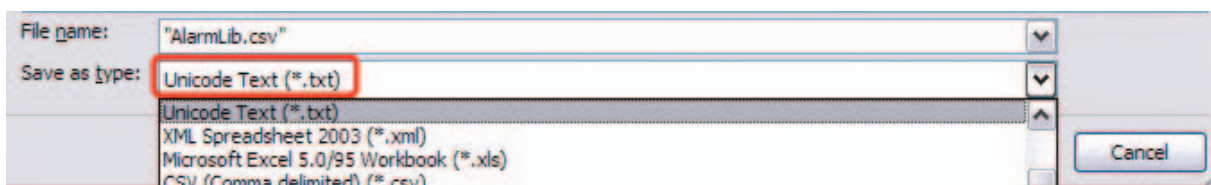

- (d) Change the extension of the saved file to csv.

### 15 Not Display Frame of Component

The frame of the component is not displayed when the component uses the graphics, but displayed when the component doesn't use the graphics, as shown below:



### 16 Gradation of Static Graphics

Gradation adds the effects to fill the graphics. And this function is useful for drawing the Vector Graphics such as the piping with the gradation effect, as shown below:

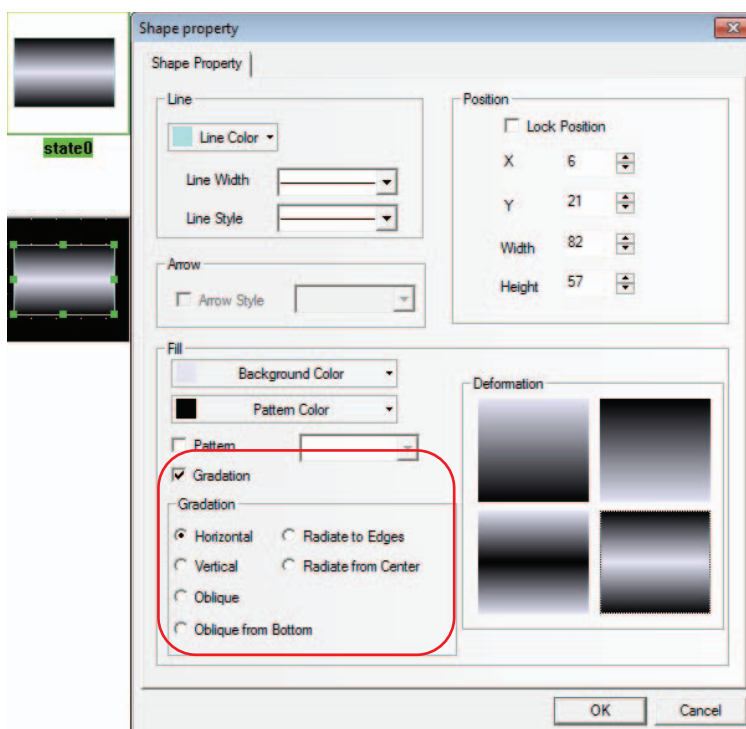

## 17 Polygon Overall Zoom

The “Overall zoom in/out” added to the polygon allows the resizing without changing the shape. After the component is clicked to turn into selecting state, one more click allows the editing the top of the polygon. In the case, the cursor is turned to be appeared as “+” as follows. When the cursor is appeared as “<->”, “Overall zoom out/in” can be performed.

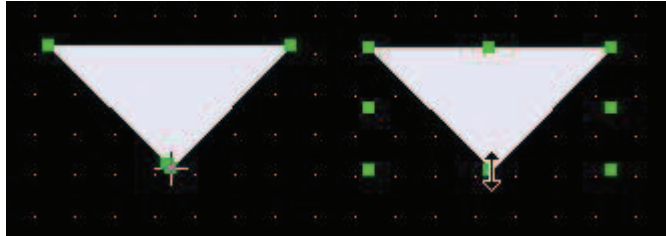

## 18 Graphics Library

The display area is divided into two parts. All the graphics in the graphics library will be displayed in the upper part while each state of the selected graphics will be displayed in the lower part.

Bitmap and Vector Graphics are supported. Bitmap in .bg format is made of images in .bmp, .gif, .jpg or .png formats or pictures. Using too many bitmaps will affect the operation speed of PT. Therefore it is recommended to use the Vector Graphics to replace the bitmaps as much as possible. The Vector Graphics in .vg format is drawn by the NB-Designer using the point, line and circle, etc.

There are 3 methods to enter the Graphics Library window.

- (1) Click [Import Graphics] in the [Graphics] tab in the component Property dialog box to enter the graphics library window (As shown below, take the Bit Switch component as example, and the other components are similar.)

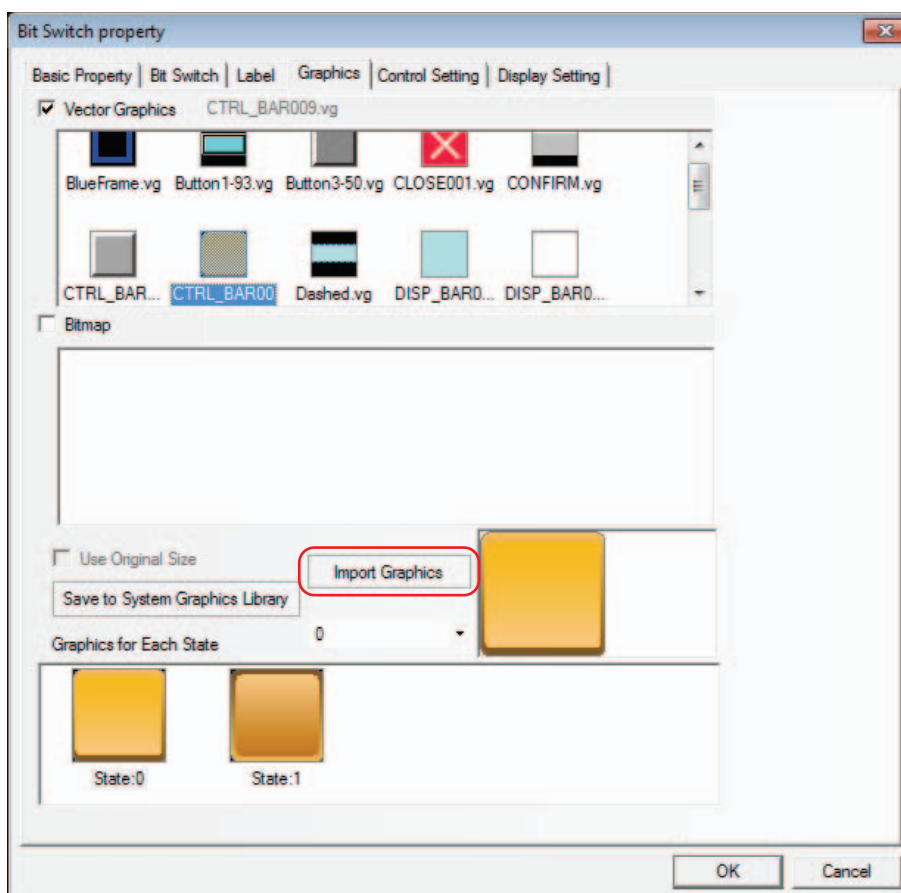

(2) Select [Import Graphics] in [Draw] menu to enter the Graphics Library window.

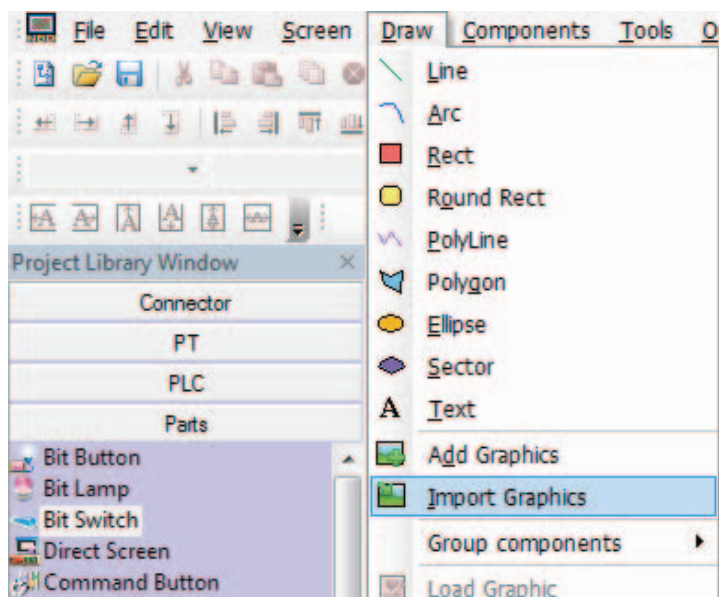

(3) Click [Import Graphics] icon in the toolbar to enter the Graphics Library window.



The Graphics Library window is shown as below:

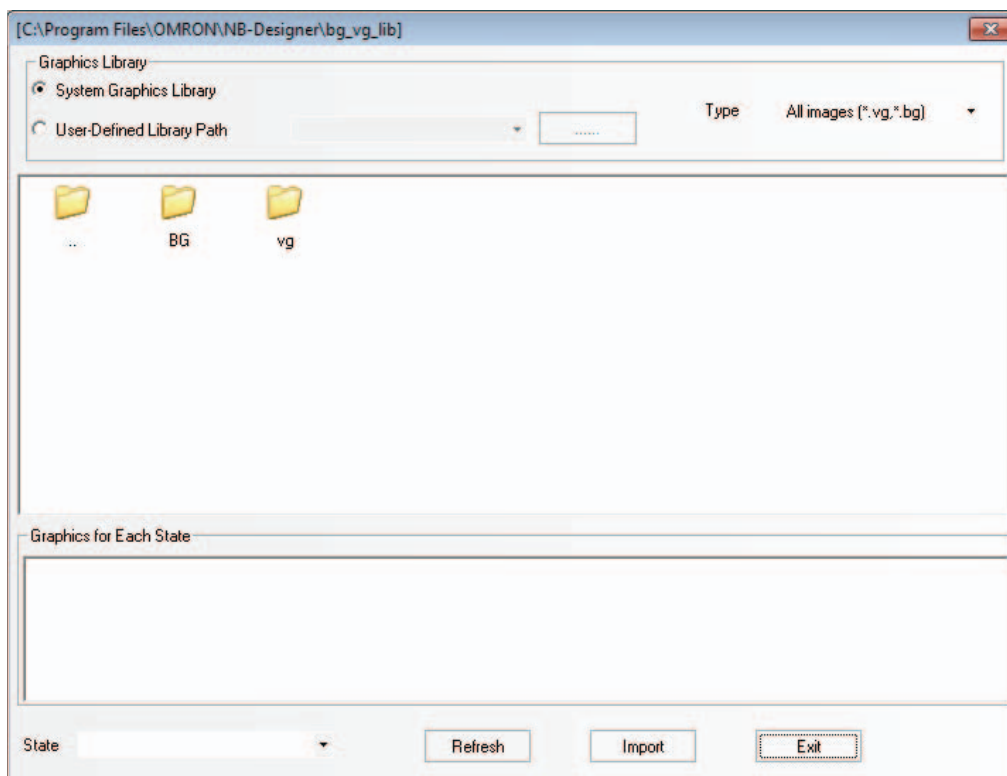



There are 2 methods for selecting the Graphics Library:

- (1) System Graphics Library: It is the graphics library provided by the software, it is under the [bg\_vg\_lib] folder in the installation folder of the software.

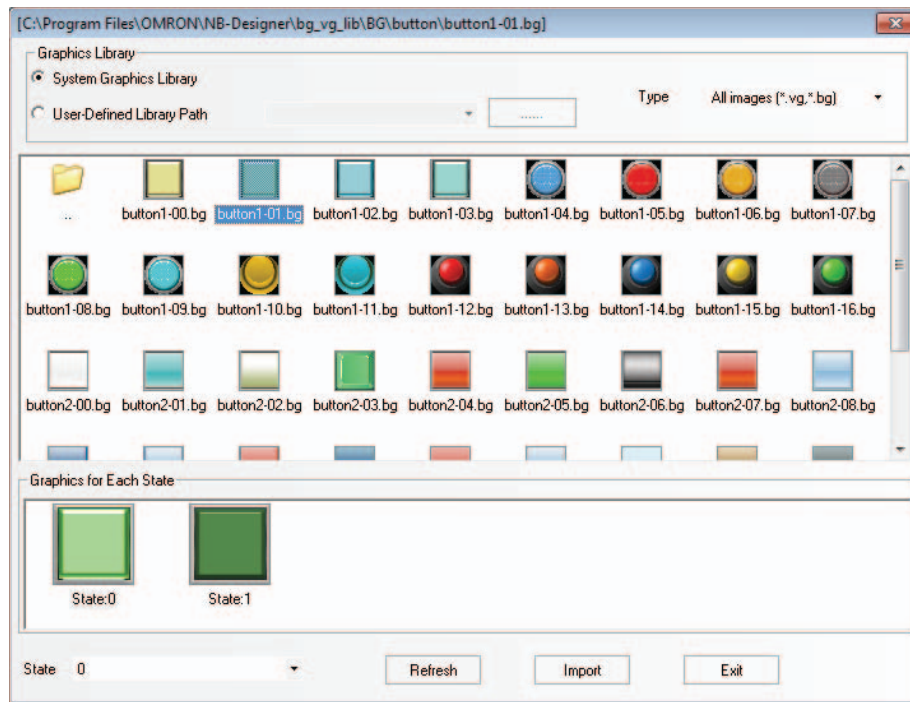

Double-click [BG] or [vg] folder, and then the bitmap images or vector graphics installed by default will be displayed. The display area is divided into two parts. And all the graphics in the graphics library will be displayed in the upper part while each state of the selected graphics will be displayed in the lower part, as shown below:



- (2) User-Defined Library Path: The folder is specified by the user to store the graphics library. With this option, graphics in the other projects can be imported. The graphics used in each project is saved in [vg] file for the project. Clicking  can reveal the file path.

The method of importing graphics is as follows:

Select one graphics, then click the [Import] button to import the graphics in the Graphics Library to the project. Each time only one graphics instead of many can be imported to the project.

The method of using graphics:

Right-click the mouse on the selected component and select “Property” in the pop-up menu, then go to [Graphics] tab to check Vector Graphics or Bitmap. The Vector Graphics is checked by default. When [Vector Graphics] is checked, all the Vector Graphics contained in the current project will be listed in the selection box of Vector Graphics, and all the states of the selected graphics will be displayed in the [Graphics of Each State] selection box, as shown below.

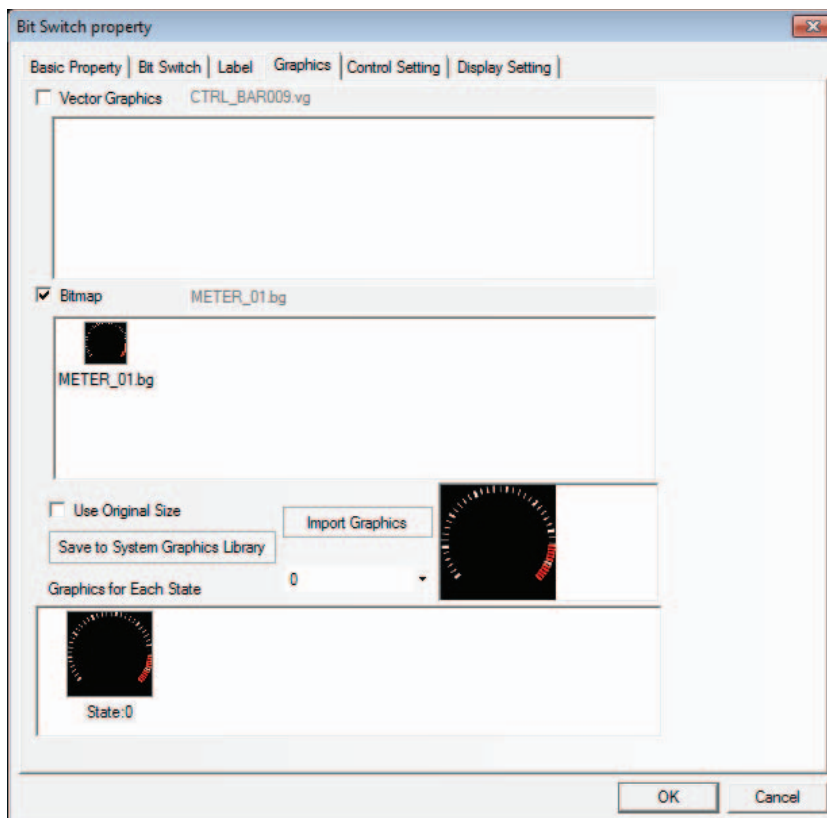
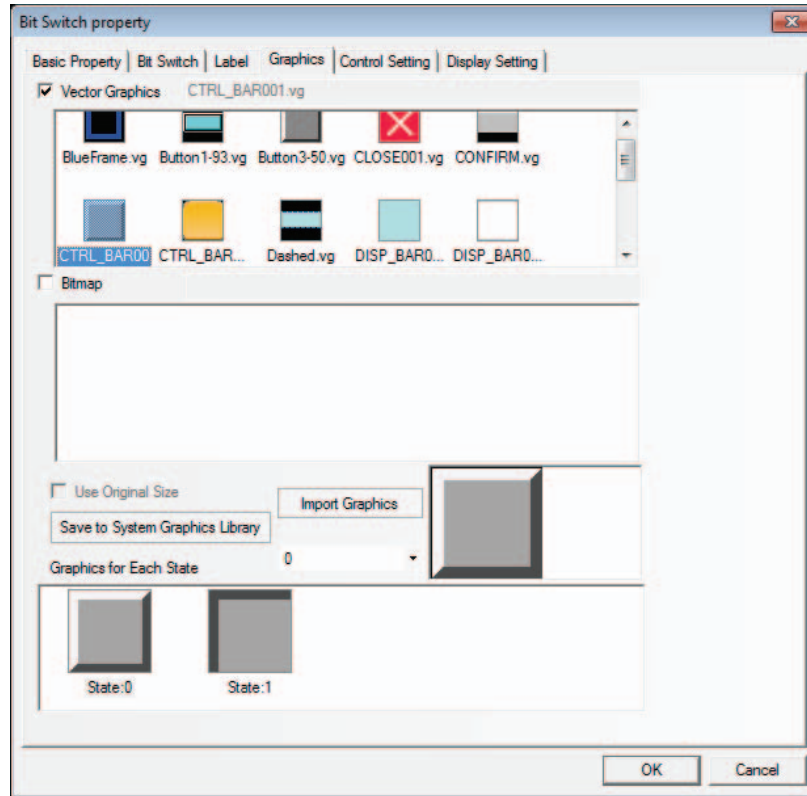

If new graphics needs to be added, click [Import Graphics].

Role of [Save to System Graphics Library] is to save the current graphics to the software for the convenient call during the creation of other projects.

There are 2 methods for [Save to System Graphics Library]:

- (1) Enter the [Graphics] tab and click [Save to System Graphics Library].

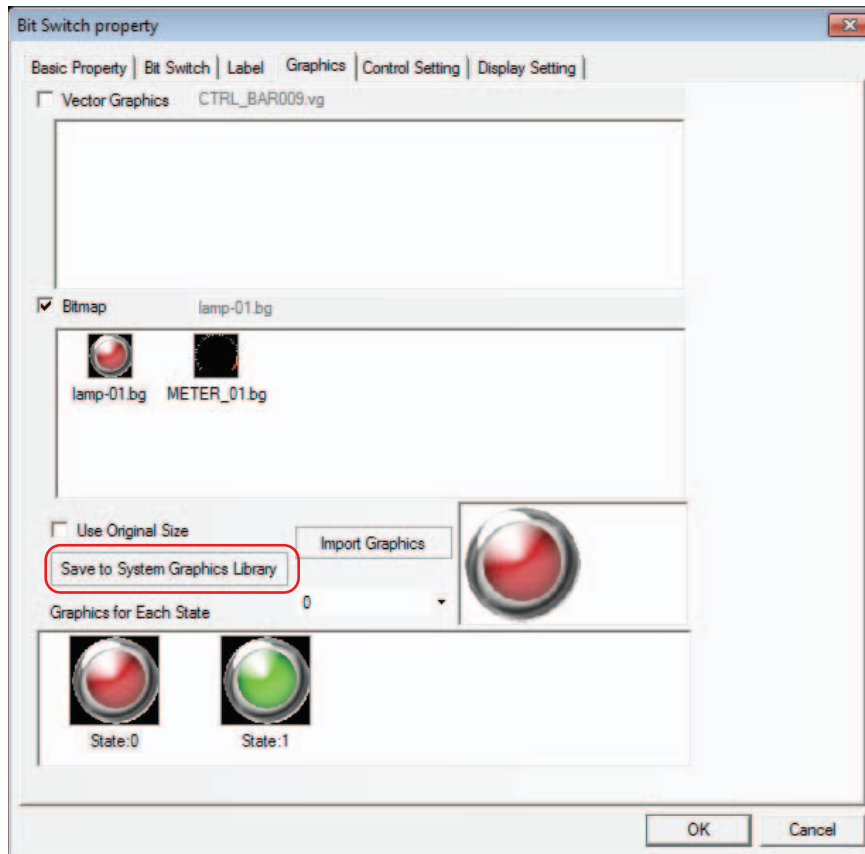

- (2) Enter the [Graphics] in [Project File Window], select the current graphics, and right-click the mouse to select [Save to System Graphics Library].

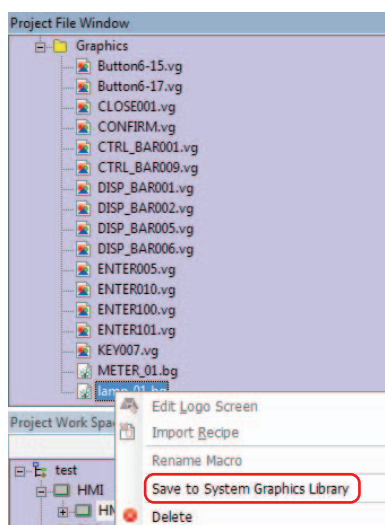

[Use Original Size] is intended for the user to conveniently make the graphics return to its original size after it is zoomed out or in.

## 19 Support Graphics in GIF or PNG Format

The graphics in .gif or .png format can be imported directly during the creation of new graphics. Using the graphics in .gif format can create the animation effect easily.

Using the graphics in .png format can create the transparent effect easily. For example, if the Level Meter is added into the reaction vessel to show the current liquid level, then one reaction vessel in .png format is needed.

For example:



Use one graphics in .gif format with the effect like .

- (1) Click [Draw] menu to select [Add Graphics], and set the Name to “next”, Type to [Bitmap] and other options to the defaults.

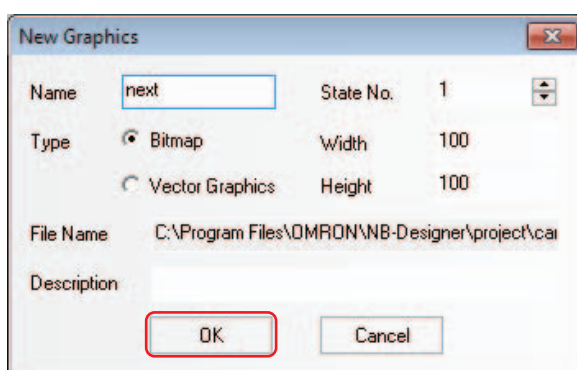

- (2) Click the [OK] button to make the following editing box appear, and select [Load Graphic] after right-clicking the mouse in the black editing box.

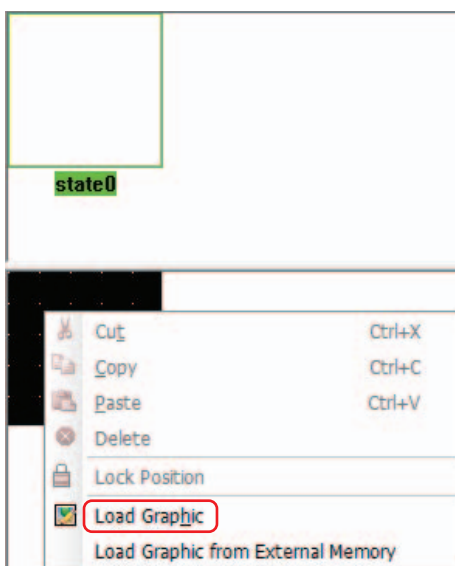

Select the graphics .

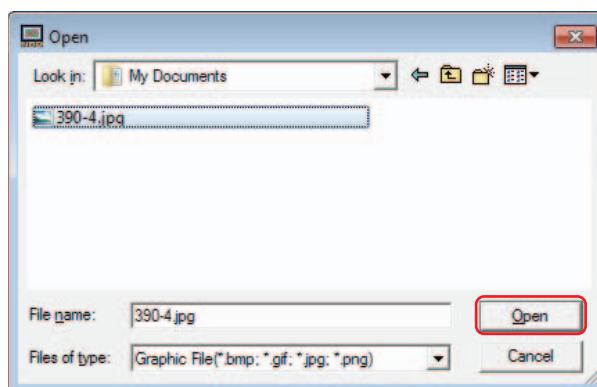



The successful import of graphics is as shown below:



- (3) After saving the project, quit from the graphic edit window and enter the edit window.
- (4) Place one Bitmap component, and check [Use Original Size].



- (5) When the offline simulation is performed, and the effect is as shown below:



## 20 Save as Vector Graphics

Storing the graphics created from multiple graphic components allows the diversion to the other screens.

The operation is as follows:

- (1) Draw a rectangle and a circle, then select these two components and right-click the mouse to select [Save as Vector Graphics].

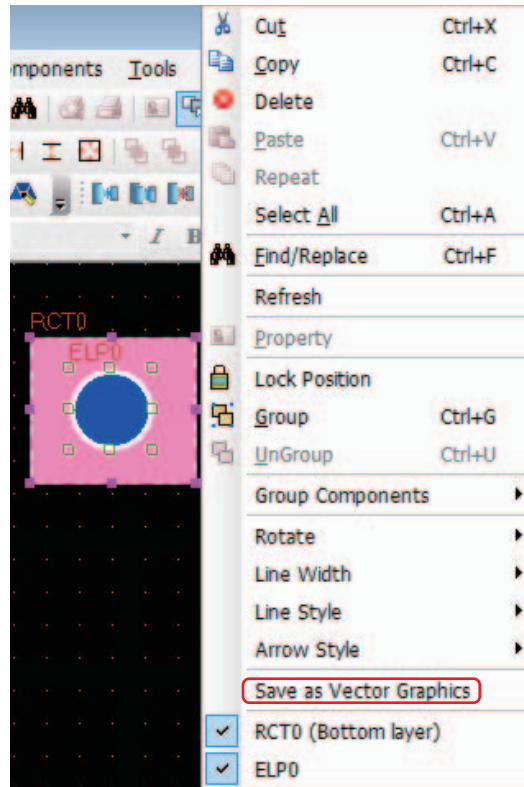

- (2) In the pop-up [Save Vector Graphics] dialog box, [New] is checked by default, and the default name is NewVG. Click the [OK] button.

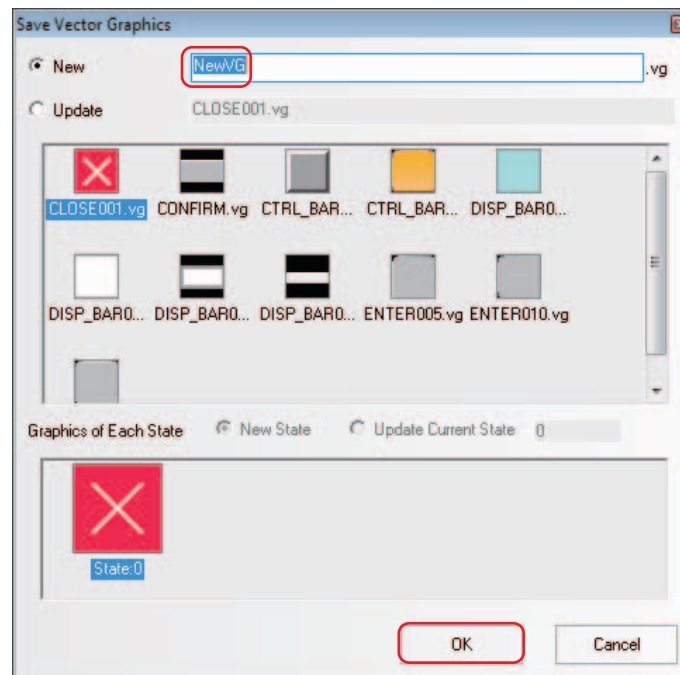

Then the creation of a new VG graphics with only one state (state0) is completed.

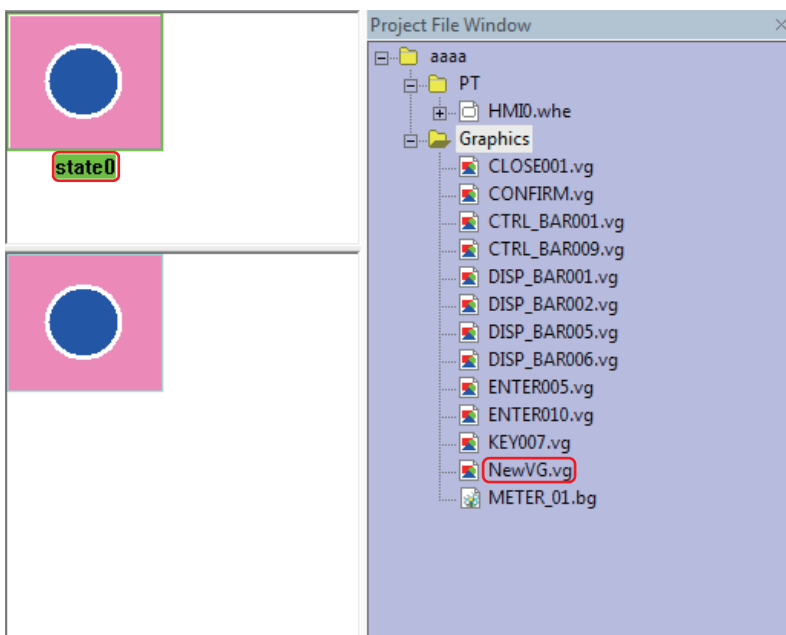

(3) For the addition of a Round rectangle into state1.

Draw a Round rectangle and select it, then right-click the mouse and select [Save as Vector Graphics].

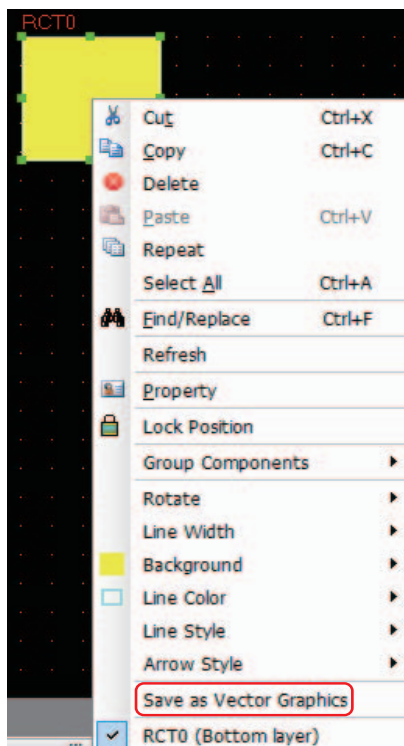

- (4) Check in the [Update] radio button in the [Save Vector Graphics] dialog box and select a NewVG.vg file. Then, select the state of the graphic to save the file.

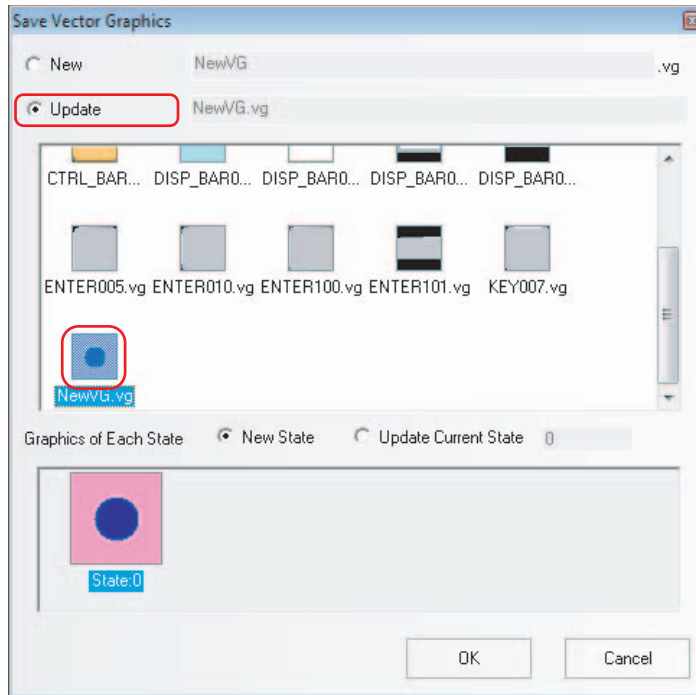

[New State]: State1 will be added.

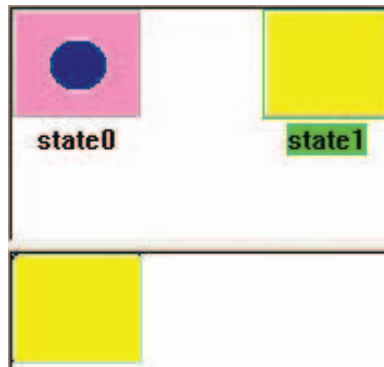

[Update Current State]: State0 will be replaced.



[Save to System Graphics Library]: The new created NewVG.vg will be saved to the system library for the convenient call of this graphics by the other projects. For the method to call graphics, refer to the *18 Graphics Library (Page 3-383) in NB-Designer Operation*.

Method of [Save to System Graphics Library]: Select the NewVG.vg in [Project File Window], then right-click the mouse to select [Save to System Graphics Library].

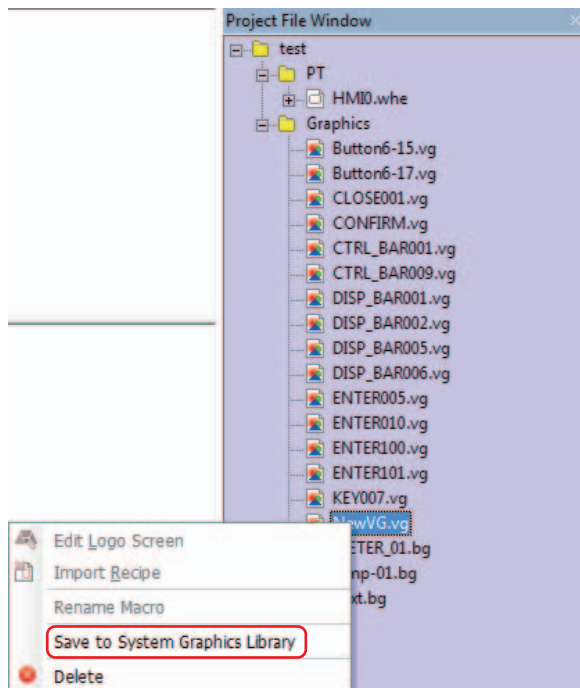

[Delete] (Method of deleting the new created NewVG.vg): Select the NewVG.vg in [Project File Window], then right-click the mouse to select [Delete].

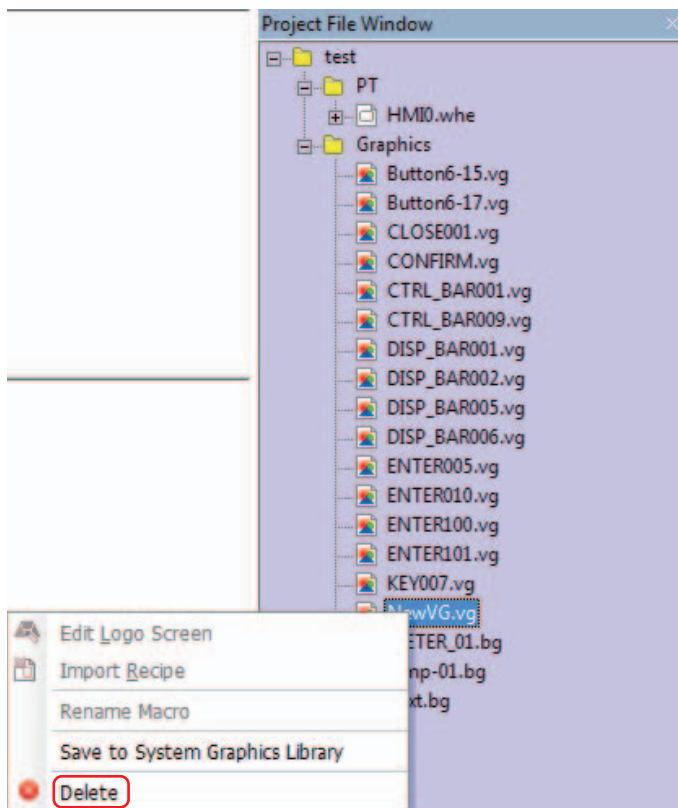

## 21 Group Components

Several components or the graphics are combined together and saved into the Group Components Library, thus making them called by other projects conveniently.

The format of Group Components Library is .pgl.

### (1) Method of entering [Edit Group Component Library]

Click [Use Group Component] in [Group components] in [Draw] menu or right-click the mouse in the blank area of the window the select [Use Group Component] in [Group Components], then the [Edit Group Components Library] dialog box will pop up, as shown below:

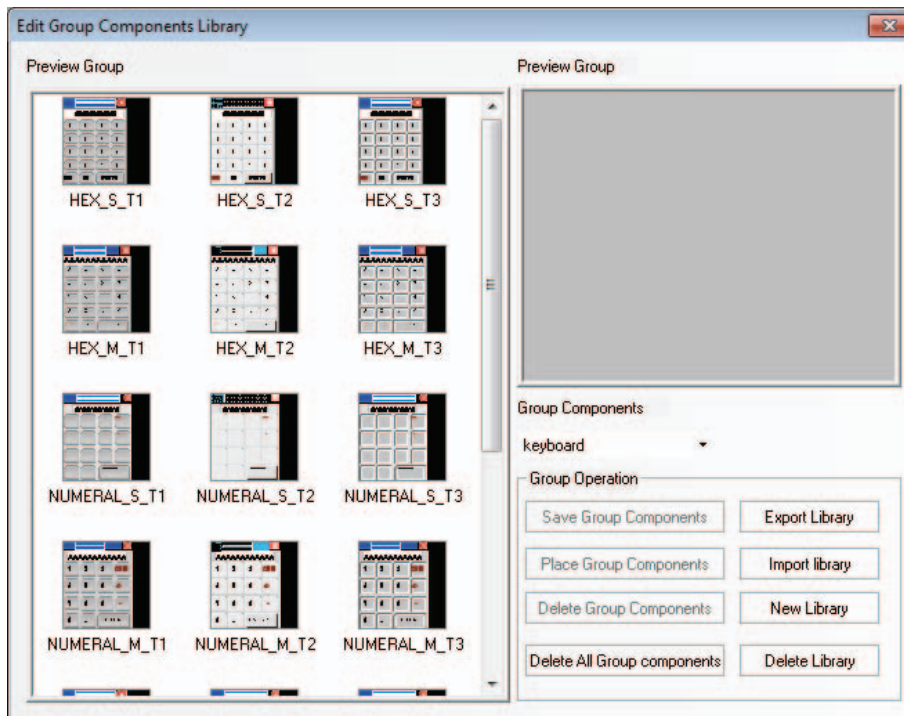

### [Export Library]

Clicking [Export Library] can make the [Group Components Library] saved to the folder specified.

### [Import Library]

The default path of group components is the usrlib folder under the installation path of NB-Designer, and the user can also import the group components library from the self-defined path. Click [Import Library], and select the required group components library in the path corresponding to the saved group components library, then click [Open] to add this group components library to the group components library of the current project.

### [New Library]

Clicking the [New Library] button will make the following dialog box pop up, and the user can input the name of this new created group components library in it. The default path to save the group components library is the usrlib folder under the installation path of the software.

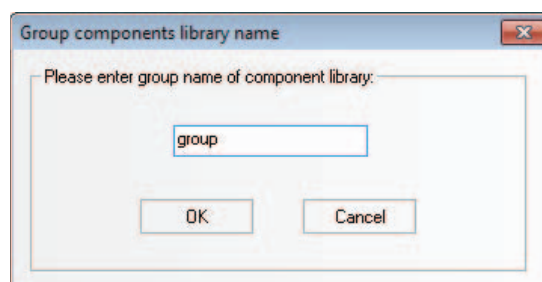

**[Delete Library]**

Clicking the [Delete Library] button will delete the group components library opened currently.

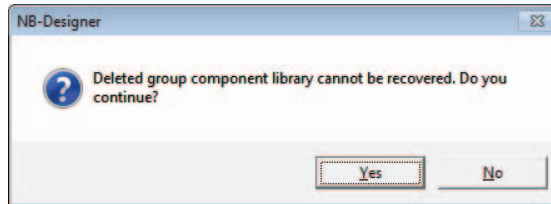

Clicking “Yes” will delete the current group components library from this project, while clicking “No” will ignore the operation done just now.

**[Delete All Group Components]**

Clicking the [Delete All Group Components] button will delete all the components in the group components library opened currently.

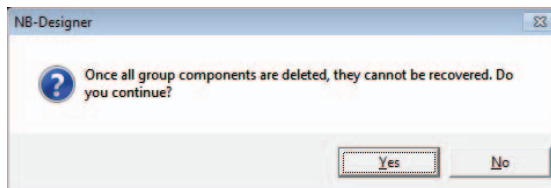
**[Delete Group Components]**

Clicking the [Delete Group Components] button will delete the components in the group components library opened currently.

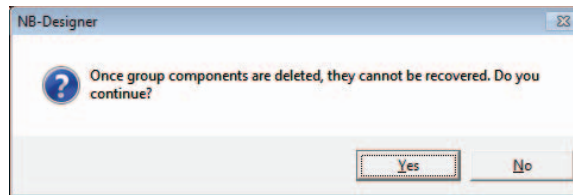

**Note** “Delete Library”, “Delete Group Components” and “Delete All Group Components” will directly delete the related files in the usrlib folder under the installation path of the NB-Designer.

**[Place Group Components]**

Clicking the [Place Group Components] button will place the selected components in the group components library opened currently into the screen edited currently.

**Additional Information**

- Some group components contain macros. If a macro with the same file name already exists in the project in which the group component is to be placed, the macro information will be output as a MacroConflict.txt file to the folder of the project in which the group component is placed.
- Some group components contain the PLC address information. If the project in which a group component to be placed does not have the same PLC, the information will be converted to LB0/LW0.

For example:

How to add group components to a new created group components library is described as follows:

- (1) Click [Use Group Components] in [Group components] in [Draw] menu, and click [New Library] after the Edit Group Components Library pops up, and input “group” as the name of the group components library in the Group component library name dialog box, as shown below:

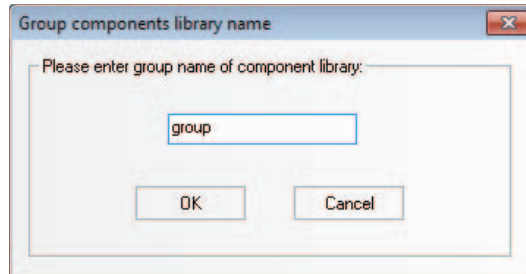

Click the [OK] button to create an empty group components library as shown below:

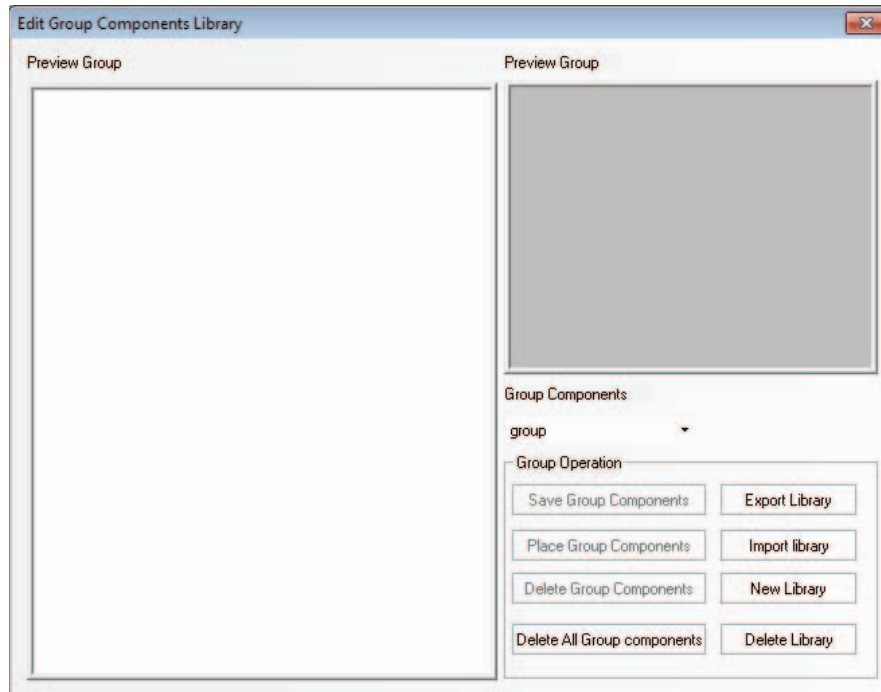

- (2) Place 3 rectangles in the screen, as shown below:

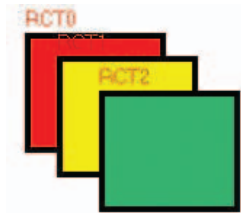



Select these 3 rectangles, and right-click the mouse to select [Group Components] - [Save Group Components], and then click the [Save Group Components] button in the Edit Group Components Library dialog box to make the following dialog box pop up.

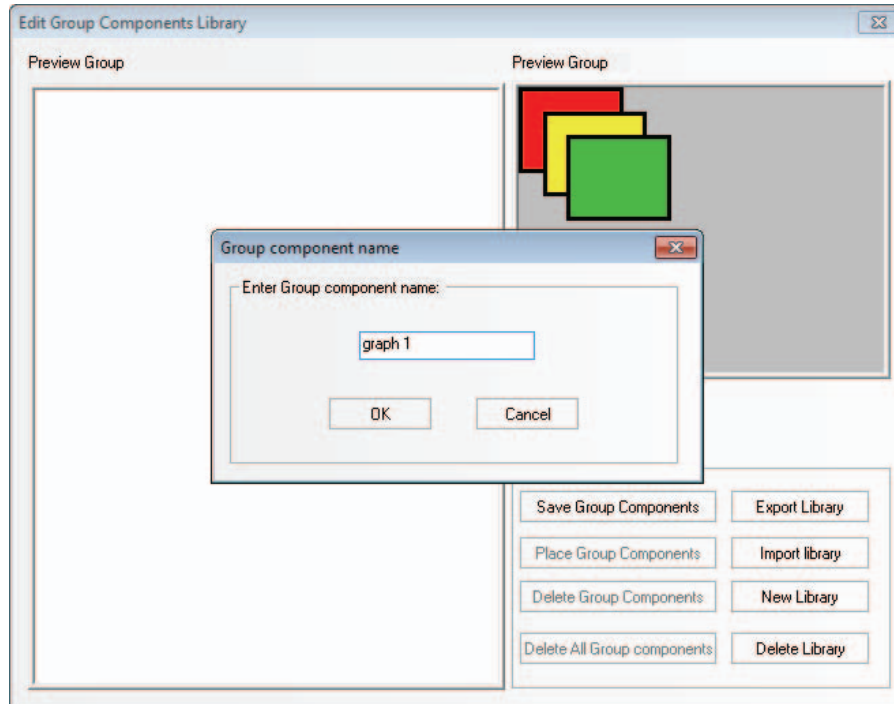

- (3) Input “graph 1” in the Part Group Name dialog box and then click the [Ok] button, then these 3 rectangles with the name of [graph 1] will be added into the new created group components library with the name of [group], as shown below:

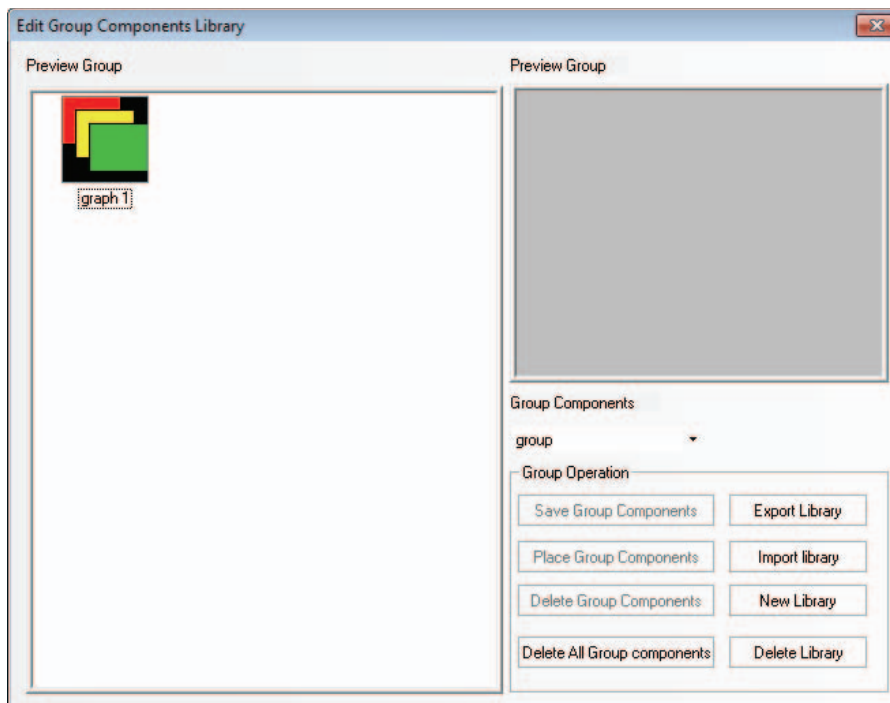

- (4) If there are other group components to be added into the group components library with the name of [group], the operation method is the same as that mentioned above. And you just need to select [group] in the Group Components location in Edit Group Components Library dialog box as the path to save it.

## 22 Edit Group Components

Group components can be edited remaining grouped.

(1) Select [Place Group Components] in [Edit Group Components Library].

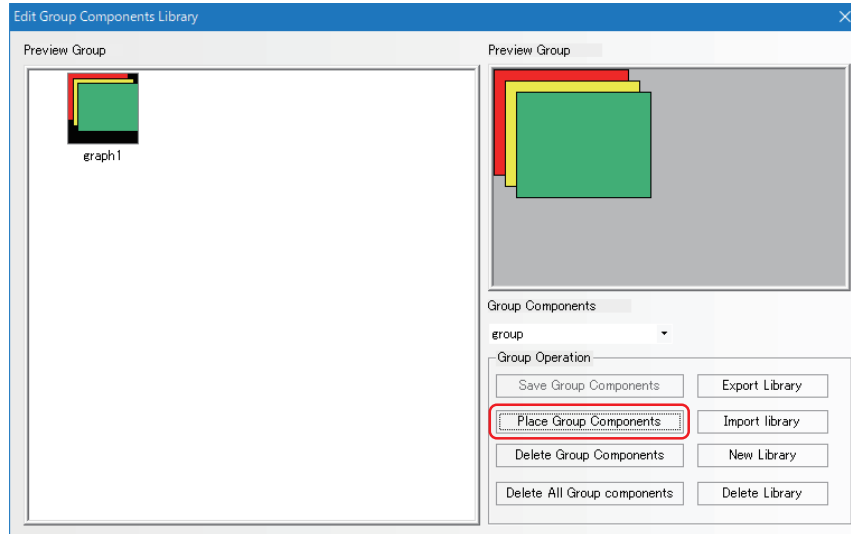

(2) Double-click a group component to display the [Group Component Info] dialog box.

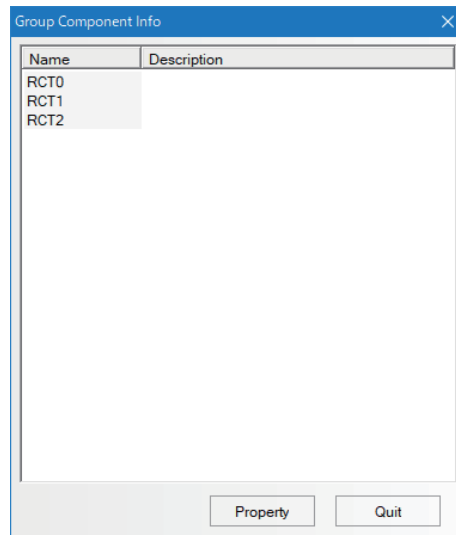

(3) Select a component and open the property window to change the component's settings remaining grouped.

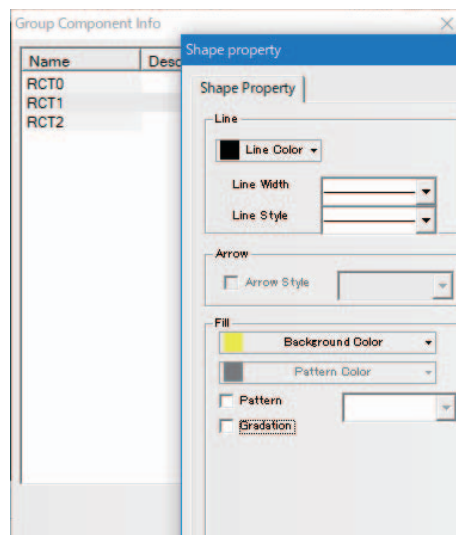

## 23 Usage of Keyboard

NB-Designer provides 21 default keyboards in [Group Components Library], and the keyboards are as follows:

3 small keyboards with different styles: HEX Keyboard (HEX\_S\_T1 to HEX\_S\_T3), NUM Keyboard (decimal, NUMERAL\_S\_T1 to NUMERAL\_S\_T3) and ASCII Keyboard (ASCII\_S\_T1 to ASCII\_S\_T3), which are applicable to the small PT with the resolution not more than 320×240.

3 middle keyboards with different styles: HEX Keyboard (HEX\_M\_T1 to HEX\_M\_T3), NUM Keyboard (decimal, NUMERAL\_M\_T1 to NUMERAL\_M\_T3) and ASCII Keyboard (ASCII\_M\_T1 to ASCII\_M\_T3), which are applicable to the large PT with the resolution not less than 640×480.

3 small grey decimal NUM Keyboards with different styles: NUMERAL\_S\_L1 to NUMERAL\_S\_L3.

How to call the keyboard in the group components library is described as follows:

- (1) Click [Use Group Components] in [Group components] in [Draw] menu, or right-click the mouse in the blank area in the window to select [Group Components] - [Use Group Components], then select [keyboard] from [Group Components] in [Edit Group Components Library], finally select [NUMERAL\_S\_T1] from [Preview Group] and click the [Place Group Components] buttons, as shown below:

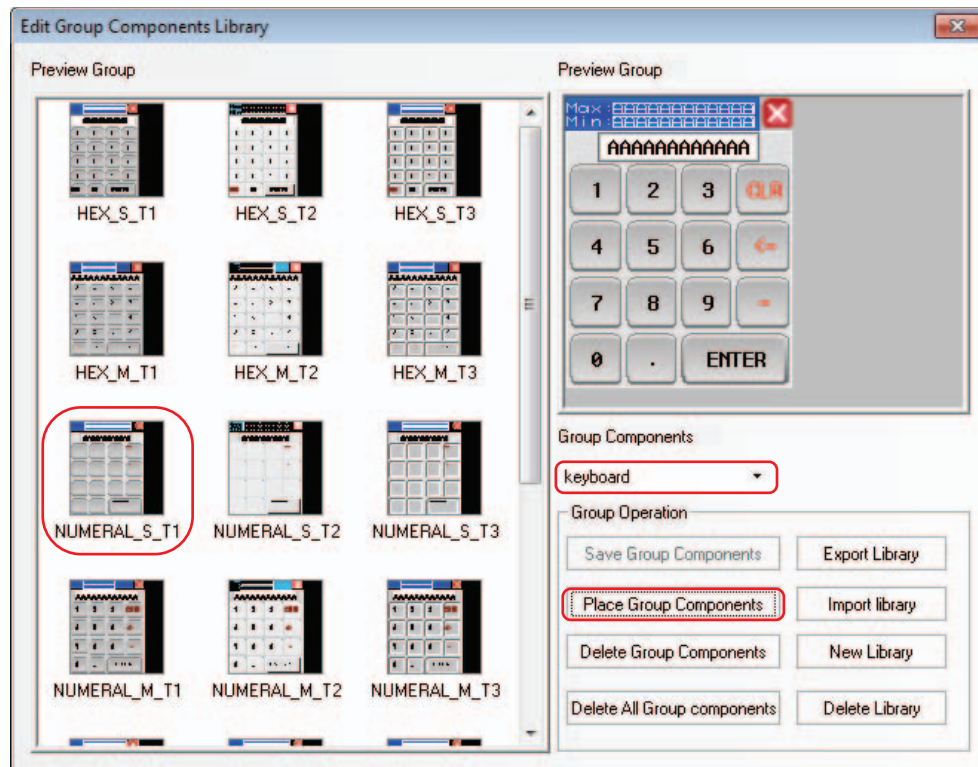

- (2) Click the [Yes All] button in the Confirm Replace Dialog.

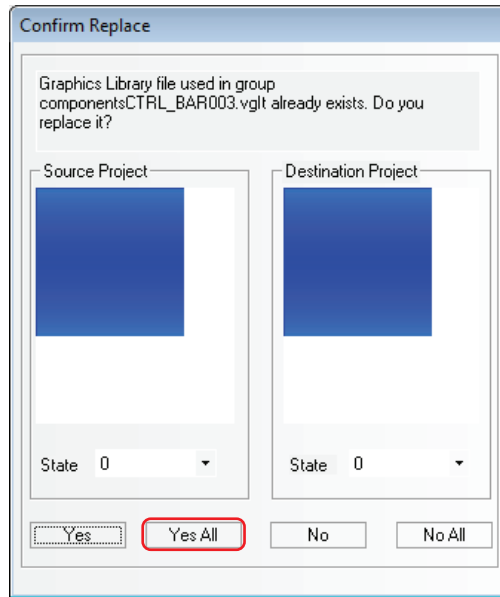

- (3) Close [Edit Group Components Library] and one keyboard will appear in the screen.



- (4) Place this keyboard in Frame 11, double-click the mouse and change Width and Height, select [Keyboard] after Special Attribute being checked and make the other settings in Screen Property dialog box, as shown below:

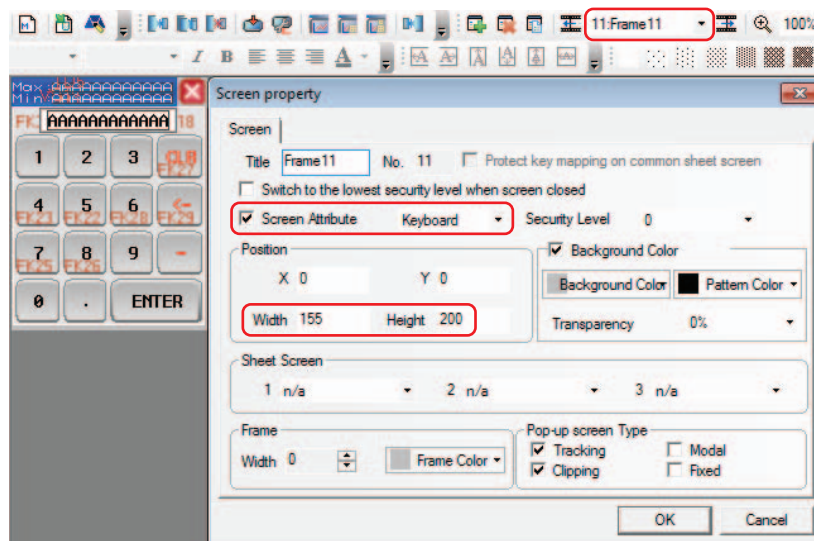

**Note** [Keyboard] in [Screen Attribute] must be selected in [Screen Property] dialog box.

- (5) Place one Number Input component in Frame 12, and select [Specify Keyboard] in [Keyboard Setting] tab, as shown below:

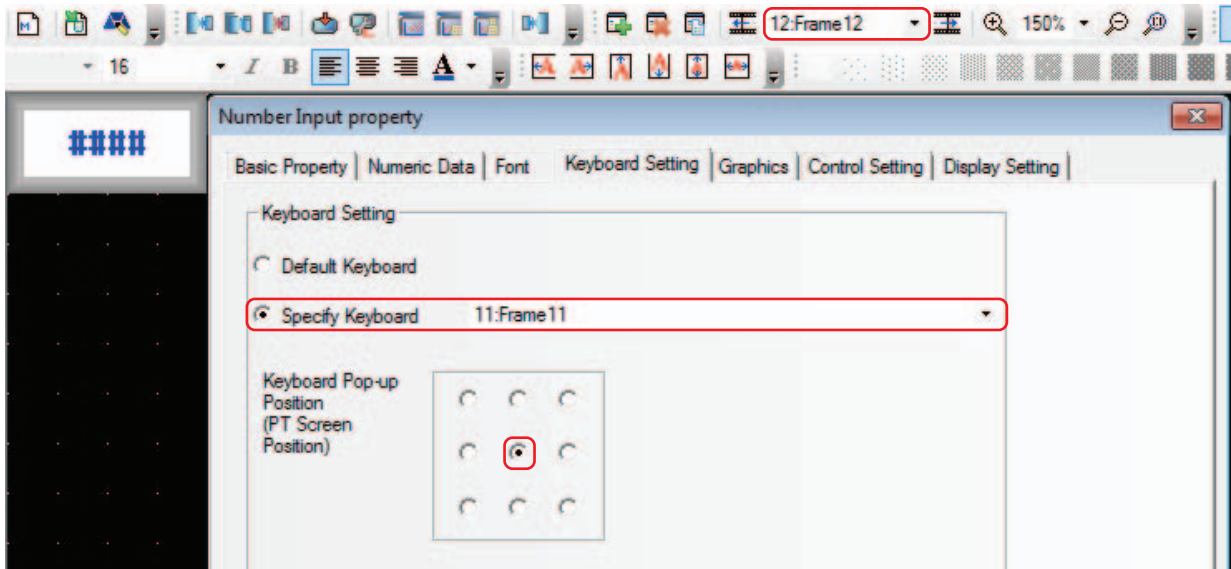

- (6) Perform the offline test and click the Number Input component to make the keyboard pop up, as shown below:



The usage of ASCII keyboard is described as follows:

- (1) Support Case: Pressing the Caps key in the keyboard can realize the case switching, as shown below:

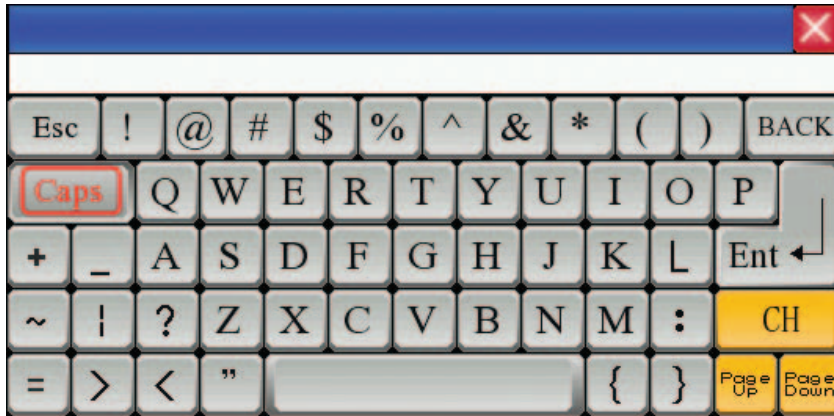

- (2) Support Chinese and English Input Methods: Pressing CH key in the keyboard can realize the switching between Chinese and English, as shown below:

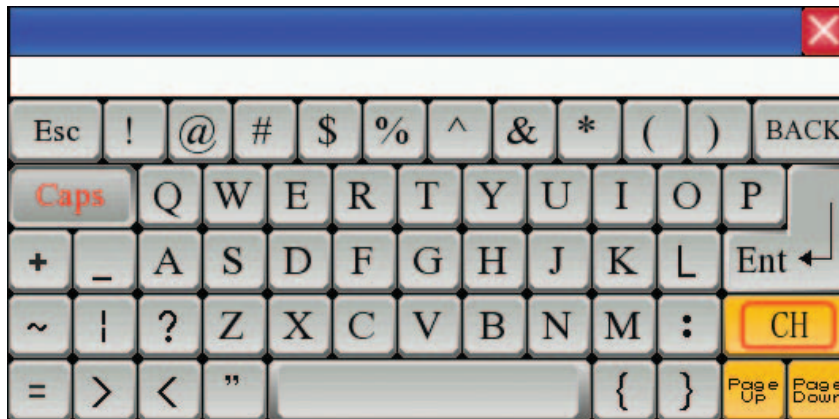

**Note** If the keyboard is called by the Pop-up Screen, [Clipping] in Pop-up Screen Type must not be checked, as shown below:

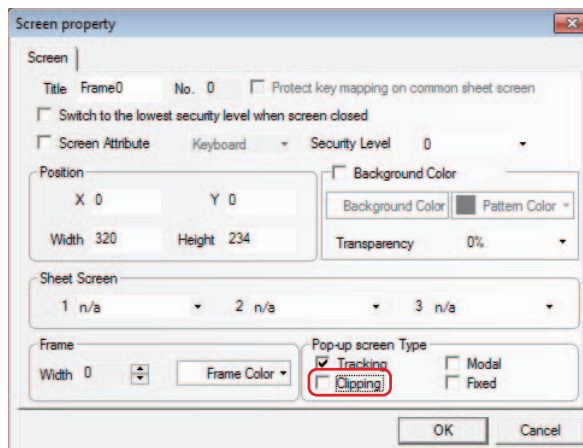

## 24 Auto Resize

Checking the [Auto Resize] check box in the [Label] tab, when the label is too long or the multiple languages with different sizes, allows adjustment the size of the component. [Auto Resize] is checked by default.

After [Auto Resize] is checked, when the length of label exceeds the width of the component, the component will be extended automatically, thus making all the contents of the label displayed completely.

If [Auto Resize] is not checked, when the length of label exceeds the width of the component, the component will not be extended automatically, thus making part of contents of the label displayed. The effect is shown as below.

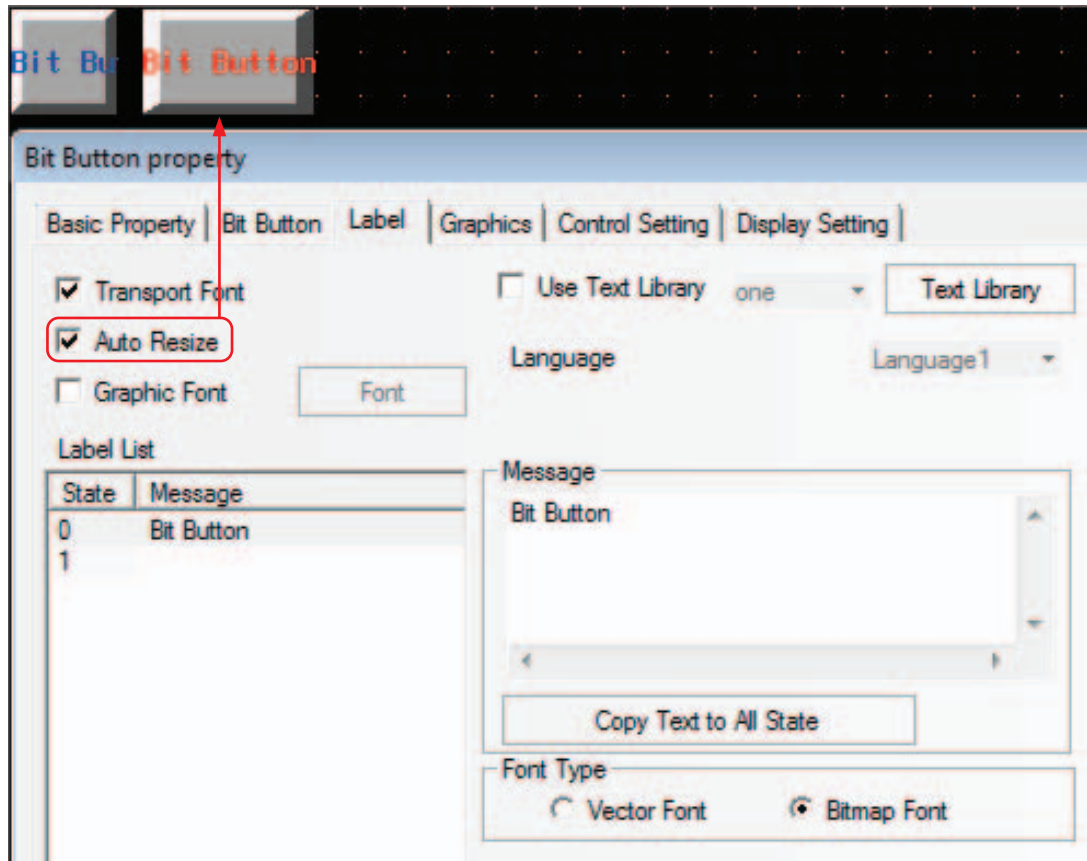

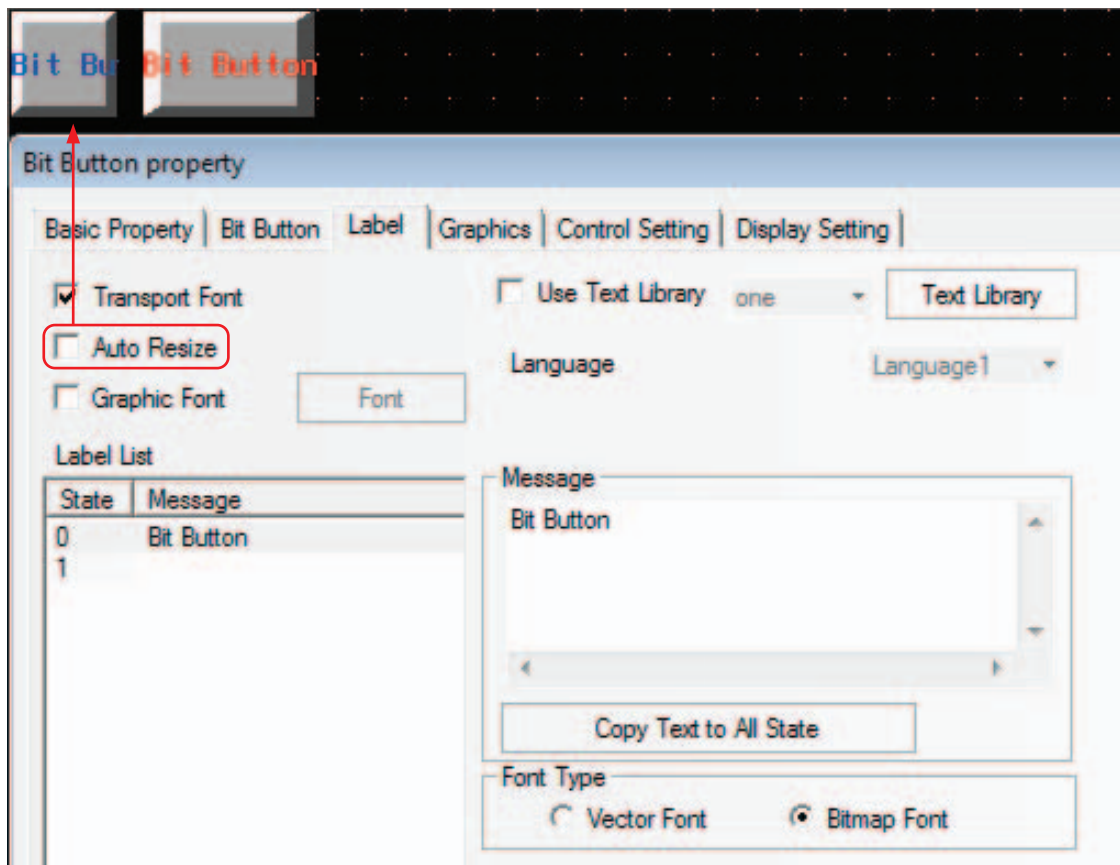

**Additional Information**

This setting can be temporarily disabled by the setting [Disable Auto Resize] in the [PT Extended Property].

**25 Overall Modify Font**

Select all the components to be modified, and click each icon in [Font Toolbar] and [Text Position Toolbar] to overall modify the properties.

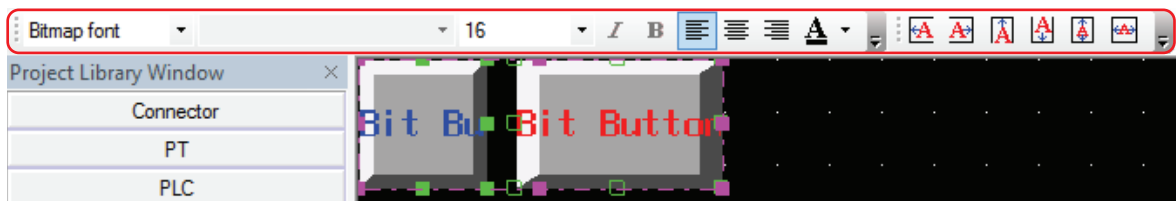



## 26 Repeat

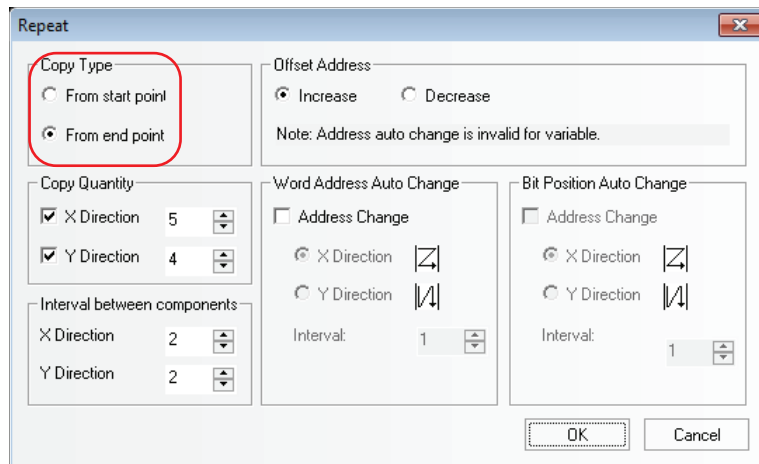

Difference between [From start point] and [From end point]:

[From end point] specifies the top in the lower right border of the component to the starting point to copy.

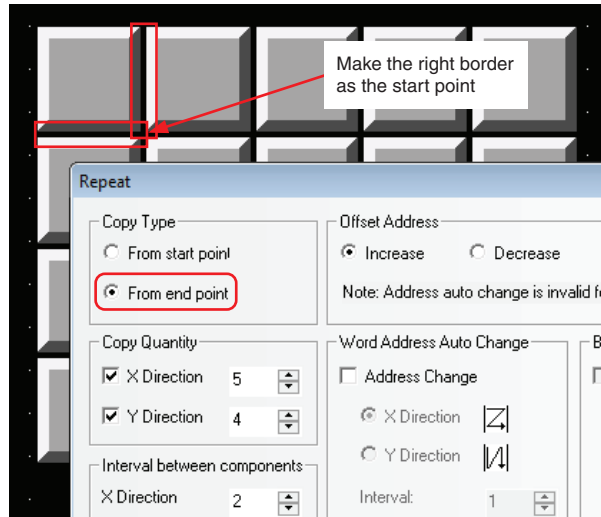

[From start point] specifies the top in the upper left corner of the component to the starting point to copy.

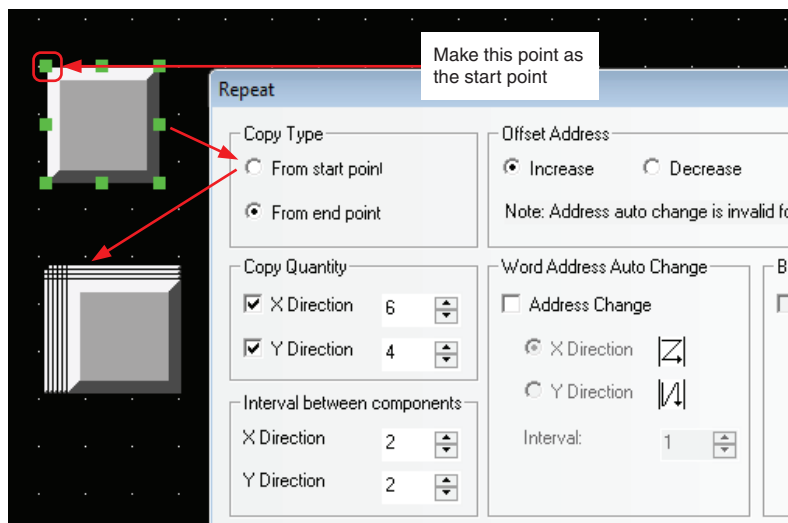

## 27 Conveniently Use System memory

If you want to use or check the System memory, check the [System Memory] check box in Basic Property dialog box. The descriptions of all the bit system memories or word system memories are listed in [Area/Variable], as shown below:

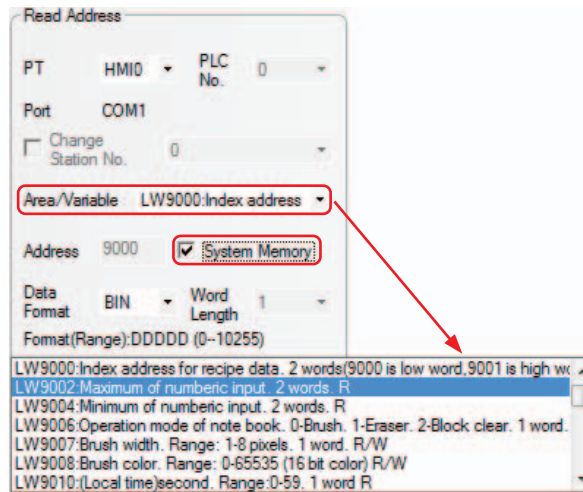

## 28 Simultaneously Open Multiple Projects/Cross-project Copy/Paste

Open 2 NB-Designers. Open 2 projects with different names, and then copy or paste the current screen by using shortcuts “CTRL+C” and “CTRL+V” or selecting [Edit] - [Copy/Paste].

## 29 Use Notifications Function to Notify Word memory

Notifications to word memories are added in [Control Setting] tab for the Bit Button component, Bit Switch component, and Number Input component etc.

Write Notice (Word)	Notice Before Written	Makes the write value written into the specified word memory before the signal of touch component is input into the controller successfully.
	Notice After Written	Makes the write value written into the specified word memory after the signal of touch component is input into the controller successfully.

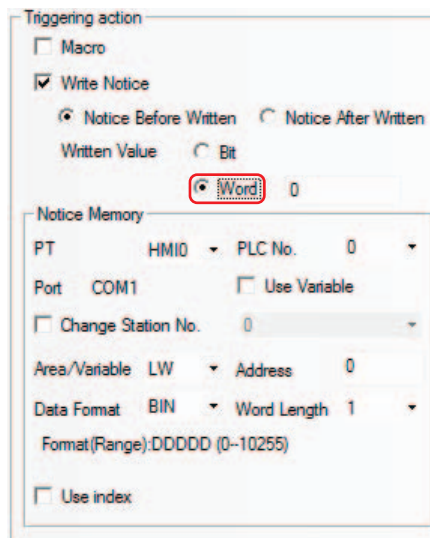

For example, Number Input component LW0 notifies LW10 to write 100 after notification. Set [Triggering action] in [Control Setting] as shown below:

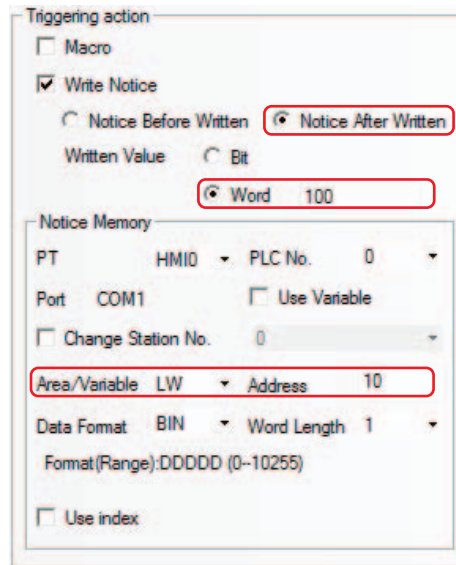

Perform the offline test and the effect is as shown below:

Before data written into LW0:

After data written into LW0:



### 30 Specify “Auto show login screen” to the Component controlled by operations

The [Touch Enabling Setting] in the [Control Setting] tab of the [Component Property] includes [Auto show login screen] function. NB-Designer makes the Frame9 as the password input screen (Login Screen), which is convenient for the user to call it when the security level or user permission is used.

Login Screen includes USER ACCESS LOGIN and USER LEVEL LOGIN screens. You can input the correct USER NAME and ACCESS PASSWORD and then click “Login” or “Logout” in USER ACCESS LOGIN screen to complete the login or logout when the user access function is used; and you can input the correct LEVEL PASSWORD in the USER LEVEL LOGIN screen to complete the level login when the user level login function is used.

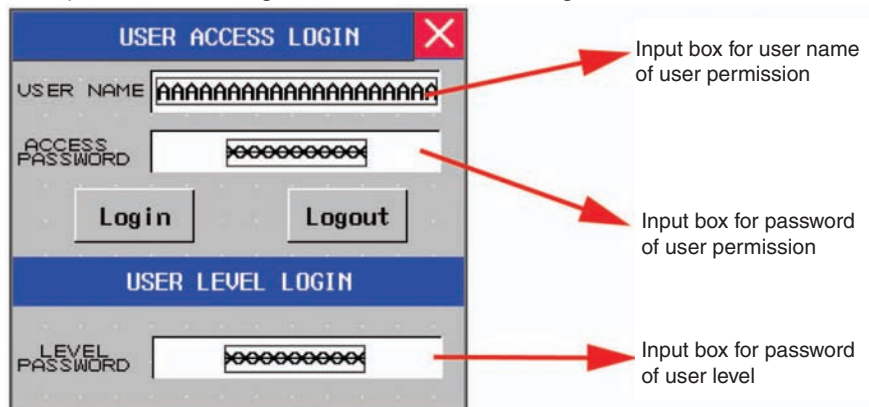

(a) How to set the “Auto show login screen”

Select “Touch Enabling Setting” in [Control Setting] tab in [Properties] dialog box of control component. Once [Security Level] or [Use Permission Control] is checked, [Auto show login screen] option will appear, and the “Auto show login screen” check box is checked, the login screen will pop up automatically.

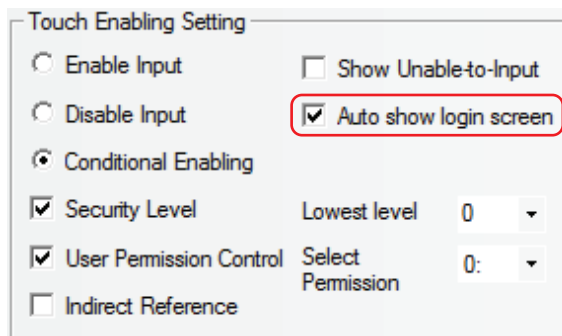

(b) Method to specify a screen as “Login Screen”

Setting the corresponding Login Screen in [PT Property] - [PT Extended Properties] can make the set screen as the “login screen shown automatically” when the Security Level or Permission Control function is used.

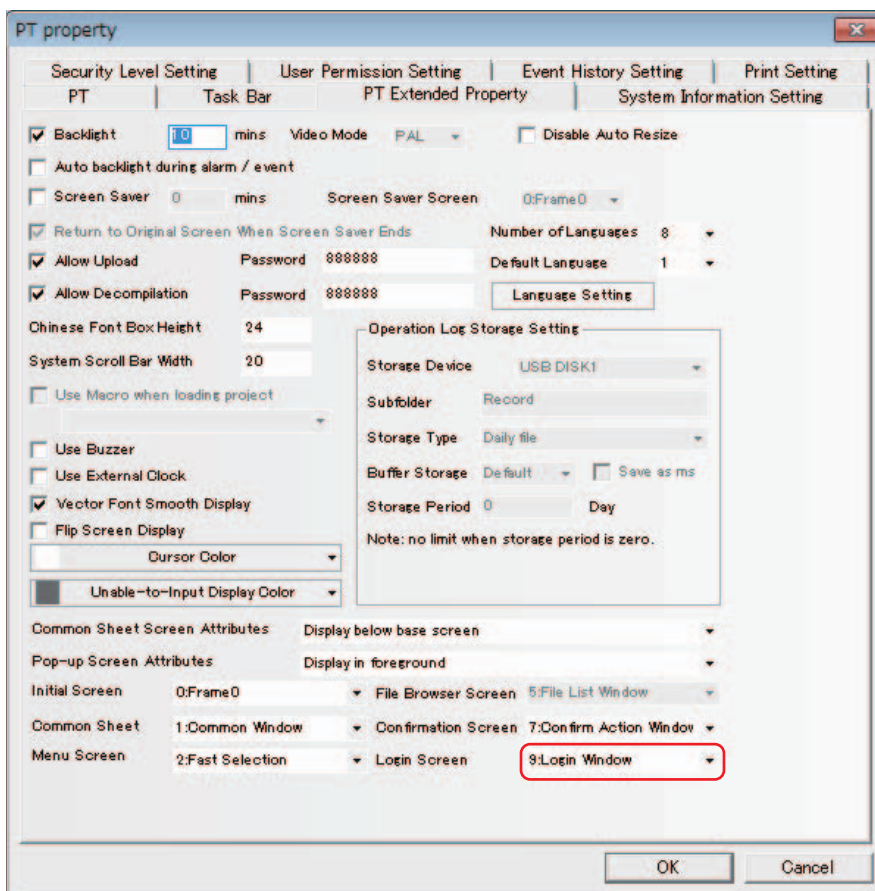

### 31 FRW, FRB, FRWI, and FRBI memories

FRW, FRB, FRWI and FRBI memories use flash memory to save the data not written frequently.

The data written to the flash memory will not be removed even if the power interruption occurs.

### 32 Index memory

Index memory realizes the convenient address operation for the user. You can modify the I/O address of the memory during the machine operation without modifying the edit screen. When the index memory is selected for the component, the new I/O address of this component = the value of the index memory + the original I/O address of this component.

For example:

- (1) Create a project and place 5 Number Input components in it.

The settings of Number Input component NI0 are as in the lower left figure shown:

The settings of Number Input component NI1 are as in the lower right figure shown:

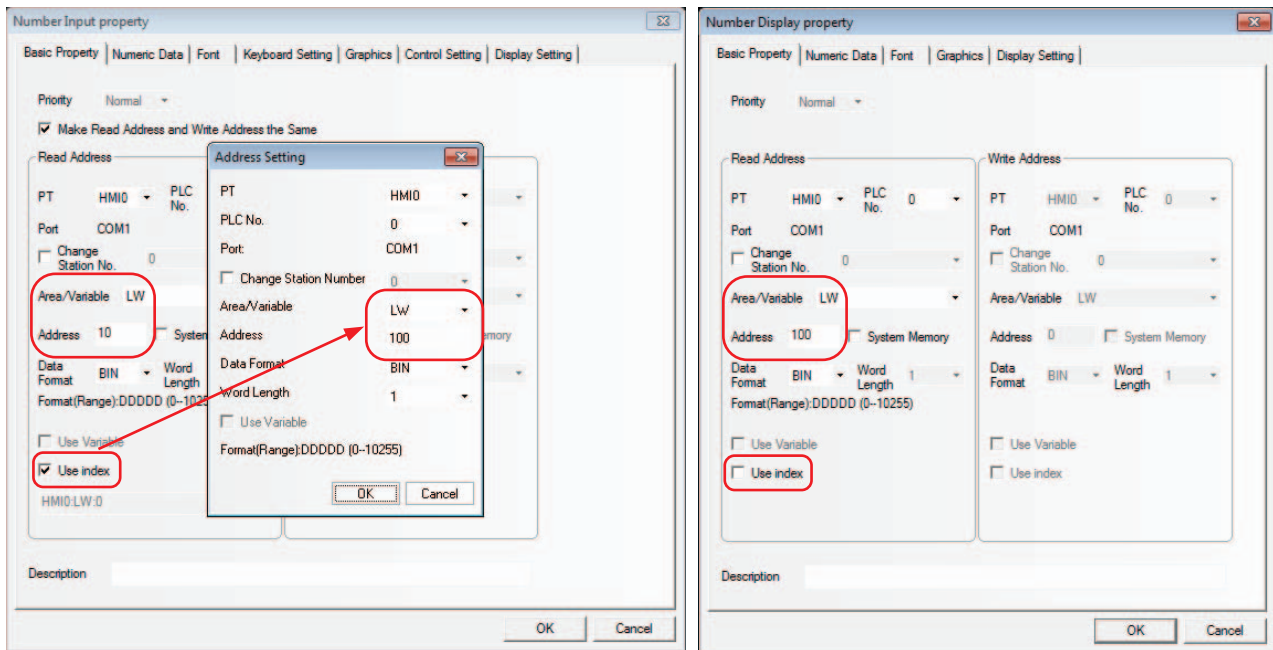

The settings of Number Input components NI2 to NI4 are the same as that of NI1, and their addresses are LW10, LW20 and LW40 respectively.

- (2) Perform the offline test. When the value of index memory is 10, the addresses of NI3 and NI0 are the same.

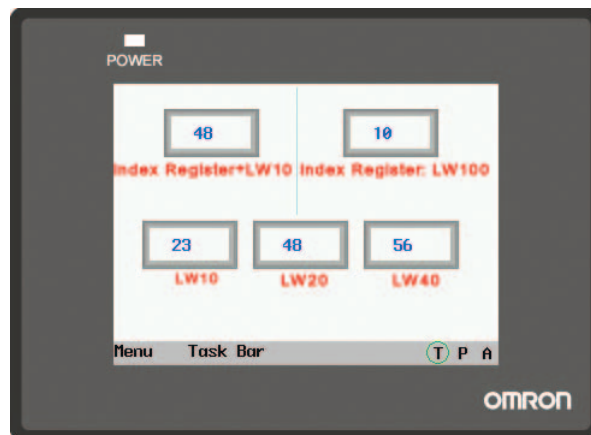

When the value of index memory is 30, the addresses of NI4 and NI0 are the same.

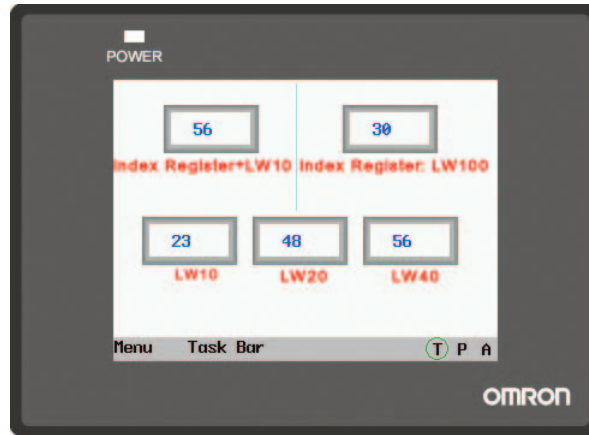

### 33 Station Num Index Function

Station number index function is invalid for the background components and Macros.

Only one PLC can be connected with the connection wire, while multiple station numbers can be set during the editing, thus it is the same effect as the connection with multiple PLCs.

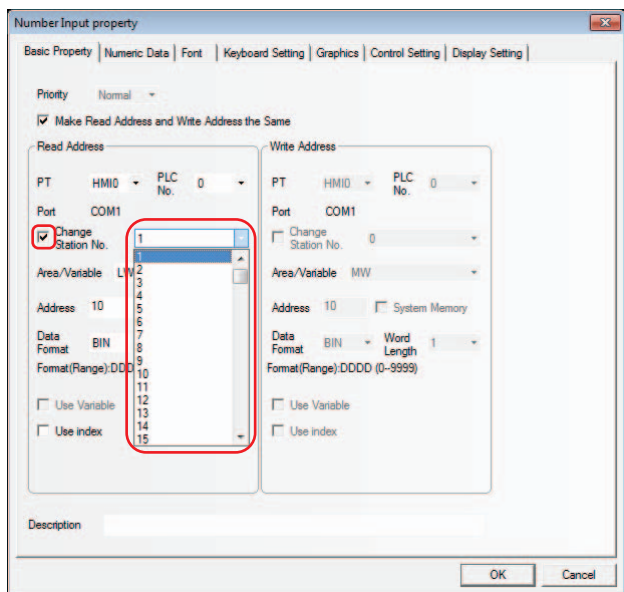
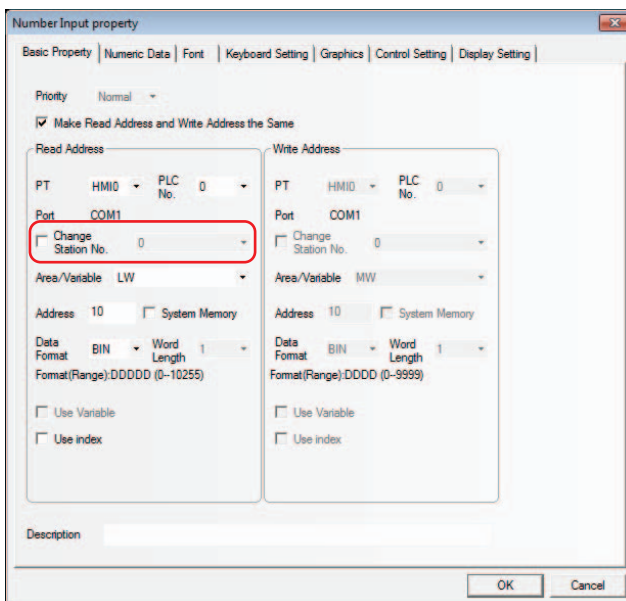
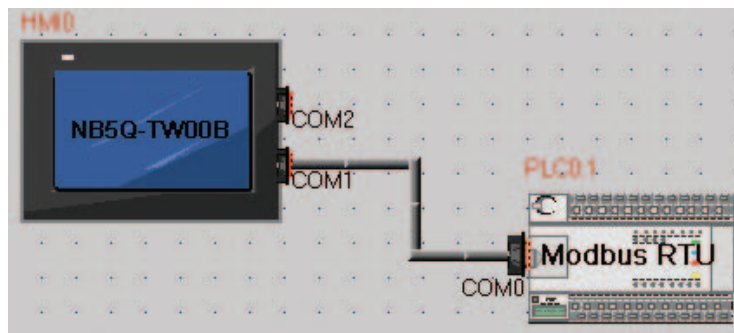

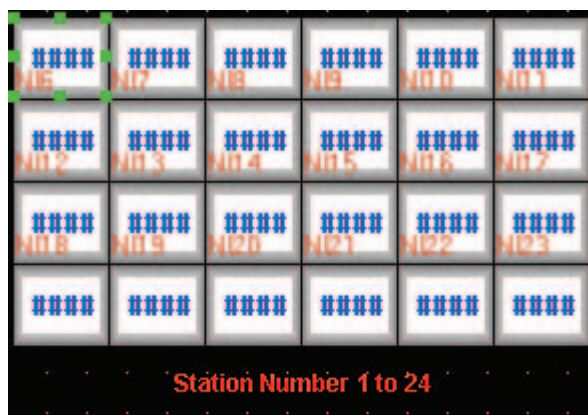

Test of Mask Station No.

9264~9279	Mask code of PLC Station No.(COM 2)	Each bit corresponds to one Station No. of COM 2 (i.e. 9264.0 corresponds to Station No. 0... and 9279.F corresponds to Station No. 255). When the bit is turned ON, the communication corresponding to Station No. will be masked (read/write).
-----------	-------------------------------------	--

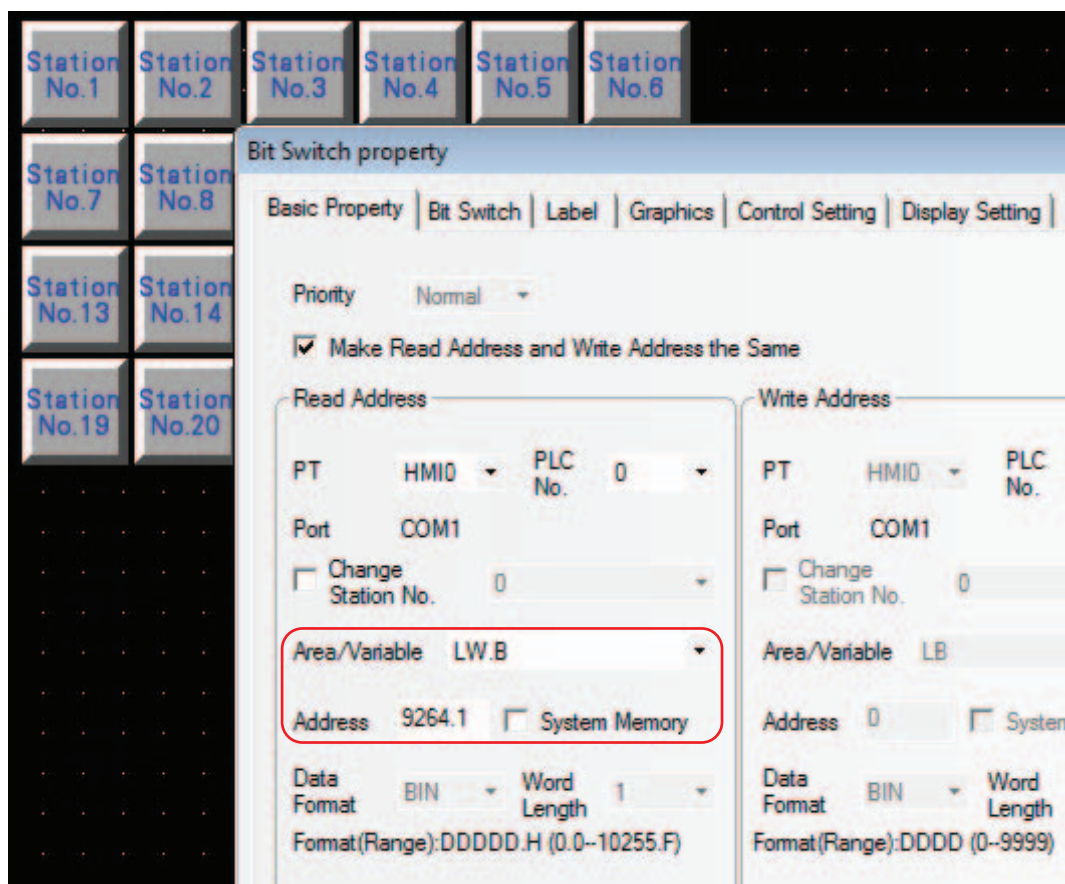

Station No. use the special memories (LW9416 to LW9431). When the special memories are used, the Station No. is determined by the value of the memory.

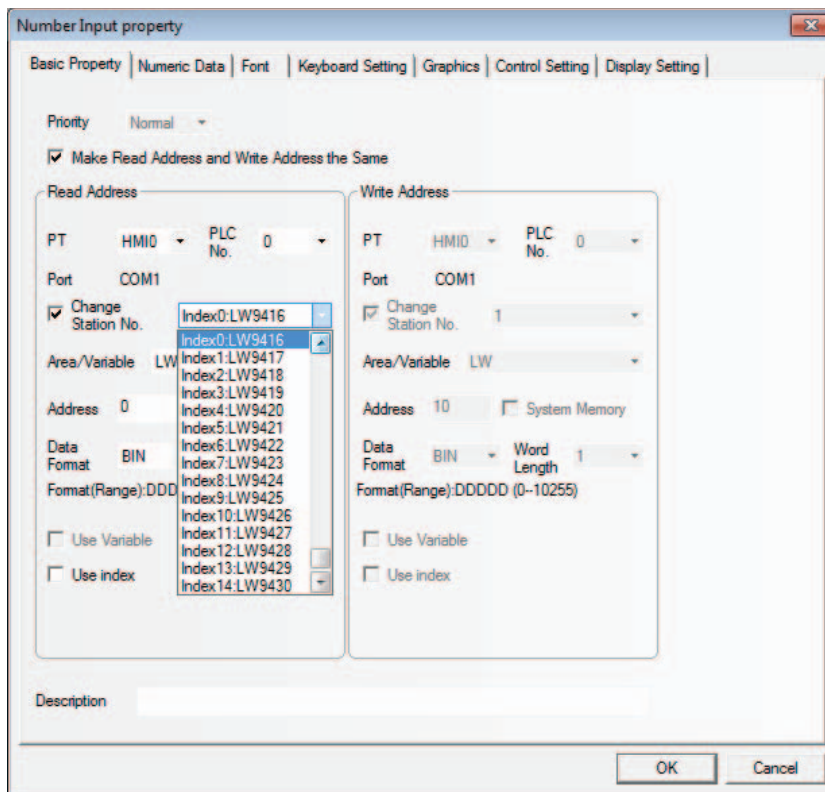

### 34 PT Mask and PLC Station No. Mask

PT Mask function:

LW9400 to LW9415 (totaling 256 bits) correspond to PT Station No. 0 to 255. When these bits are set to ON, the access to the corresponding PT numbers will be masked.

PLC Station No. Mask Function:

9264~9279	Mask code of PLC Station No.(COM 2)	Each bit corresponds to one Station No. of COM 2 (i.e. 9264.0 corresponds to Station No. 0... and 9279.F corresponds to Station No. 255). When the bit is turned ON, the communication corresponding to Station No. will be masked (read/write).
-----------	-------------------------------------	--



Taking an example the case using masking function for HMI0, the corresponding of LW memory and masking object is displayed as below.

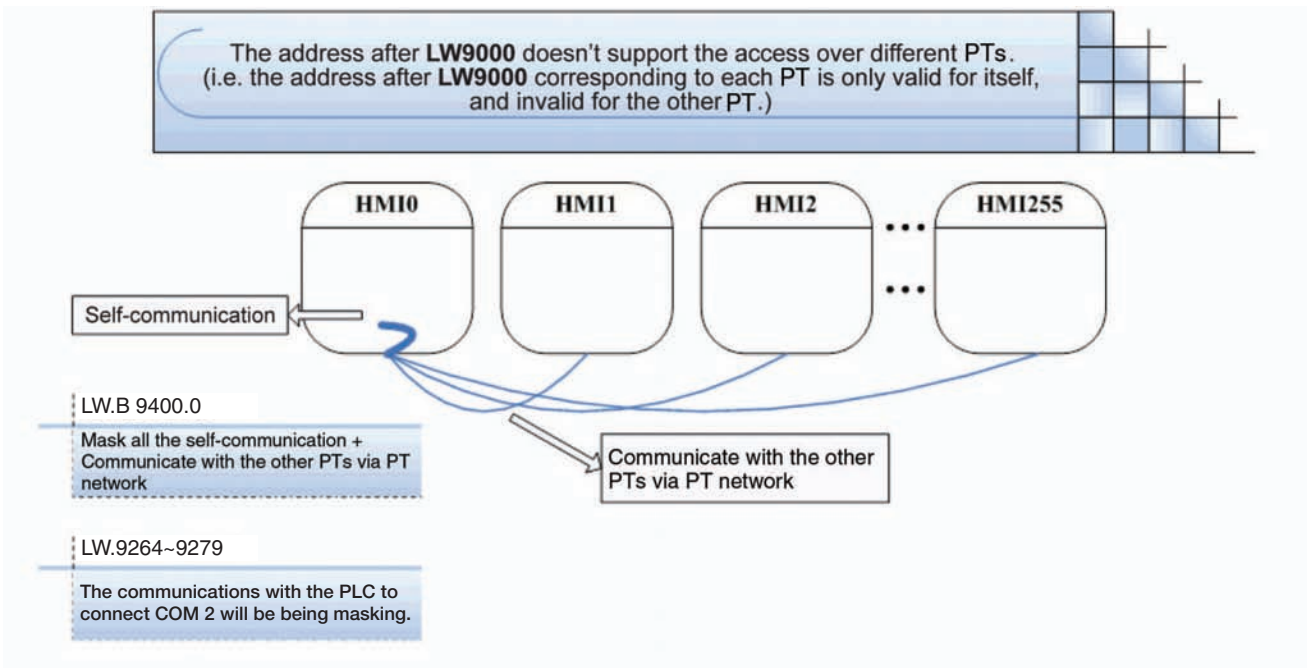

### 35 Mask System Prompt Information

NB-Designer provides the system information mask function which is controlled by the special memories LW9296 (read/write) and each bit corresponds to one piece of system error information, and the system error information will be masked when the corresponding bits are set to ON. For example, LW.B9296.2 corresponds to the prompt information "PLC No Response".

**Note** Place Bit Button component and others in the screen which should be being masking of error display and specify [Set to ON when screen is open] for Type and specify LW.B9296.2 to On.

Take Mask of "PLC No Response" as example

- (1) Create one project, and connect NB5Q-TW00B with SIMENS S7-200 for communication.

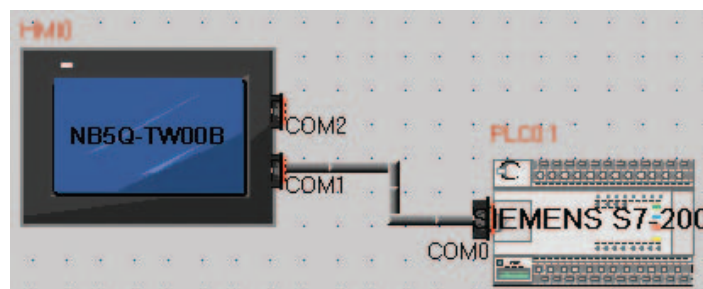

- (2) Place one Number Input component VW0 (One memory in Siemens S7-200) and one Bit Button component with the address of LW.B9296.2 and Type of "Bit Button" in Edit Window.
- (3) Actually, PT0 is not connected with Siemens S7-200 PLC. The prompt information of "PLC No Response" should appear before, but now the system error prompt information doesn't appear for the LW9296 mask function.

## 36 How to clear RW area for recipe saving

### Clear the address by system memory related RW memory

- (1) Set the Read Address to LW9260 and input the starting address objected of clearing RW area to the Number Input component which is specified the word length to [DWORD].
- (2) Set the Read Address to LW9262 and input the word length objected of clearing RW area to the Number Input component which is specified the word length to [DWORD].
- (3) Set LB9130 (PT system memory) to ON and clear the content of RW area.

### How to clear values of RW at a time:

- (1) Specify this parameter using the [Clear system memory related to RW memory] method. In order to clear the stored values in RW memory, specify the longest word length of RW memory to the range from LW9262 to LW 9263.
- (2) Select “Clear Recipe” in “Select Section” for downloading the NB Manager and click “Execute”.
- (3) Check the [Clear Recipe] check box during the download.

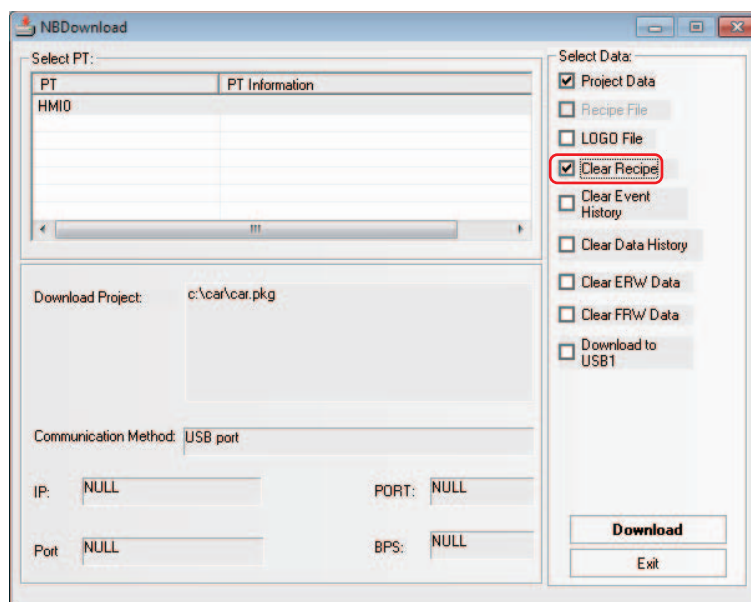

## 37 Data Encryption

For the data stored in the CSV format in the external memory, data encryption function can be used to restrict the modification, edition, and others by the user.

- Note 1** If the [Decompile] operation is not performed to the CSV file generated for the component using [Data Encryption], the illegible characters will be displayed in the opened CSV file.
- 2 If the [Decompile] operation is performed through the NB-Designer, the CSV file can only be opened for viewing instead of modifying or editing.
  - 3 If the encrypted file is modified by someone intentionally, the error prompt will appear during the [Decompile] operation in NB-Manager, making the damage of source file informed to the user.
  - 4 The components supporting [Data Encryption] function are Data Log, XY Graph and Data History components.
  - 5 When the data encryption is set, the display of the component is also encrypted.

Take the setting method of [Data Encryption] for sampling data file of the Data Log as example:

- (1) Check the [Data Encryption] option after the [Save to External Device] option is checked in the [Save Data History] tab in the [Data Log Property] dialog box.

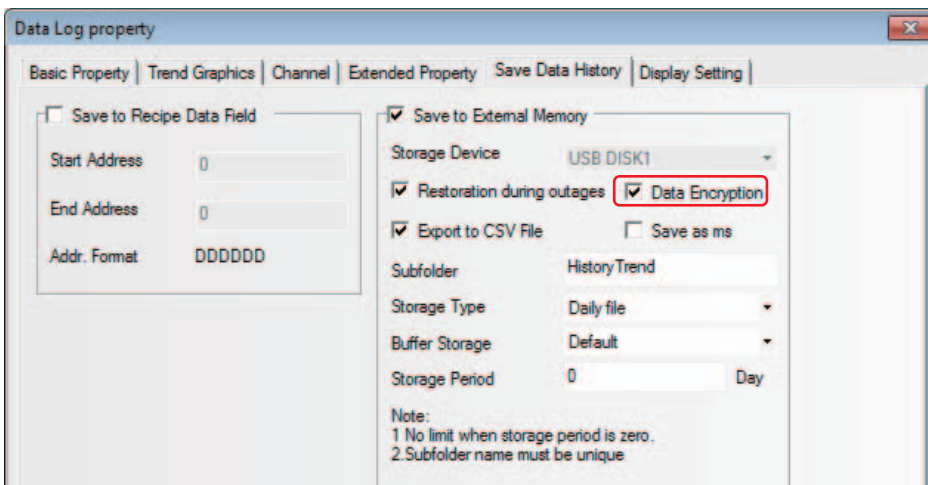

- (2) The illegible characters will be displayed in the generated CSV file after the encryption if it is directly opened.

	A	B	C	D	E
1	TIME	CHO			
2	(2IY1)	嫫 璘			
3	(2IY1)	郟 聃			
4	(2IY1)	郟 聃			
5	(2IY1)	郟 聃			
6	(2IY1)	郟 聃			
7	(2IY1)	郟 聃			
8	(2IY1)	郟 聃			
9	(2IY1)	郟 聃			

Using the [Data Encryption] function

	A	B	C	D	E
1	TIME	CHO			
2	10:57:37	11			
3	10:57:38	22			
4	10:57:39	33			
5	10:57:40	44			
6	10:57:41	55			
7	10:57:42	66			
8	10:57:43	77			
9	10:57:44	88			

Not using the [Data Encryption] function

(3) The procedure of decompiling the CSV file by using the [Decompile] function of NB-Manager is as shown below:

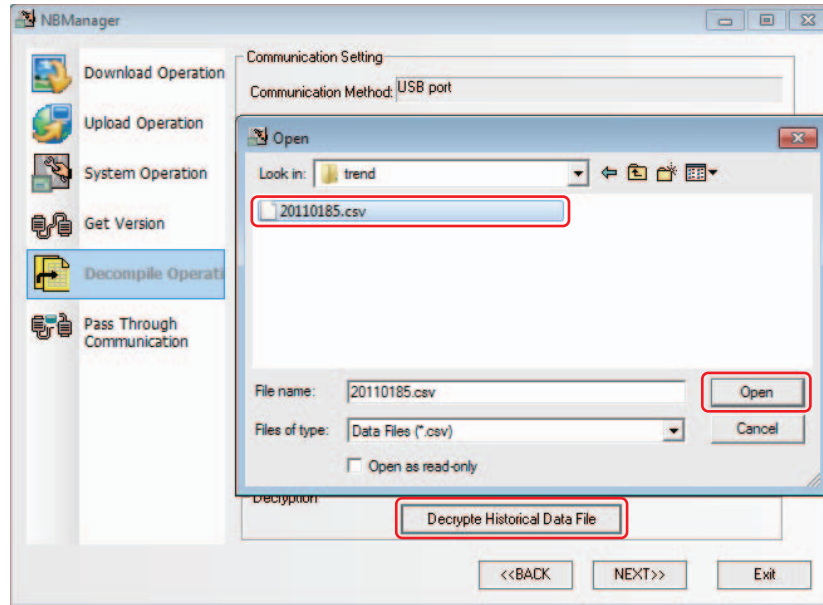

The following dialog box will pop up after the successful decryption.

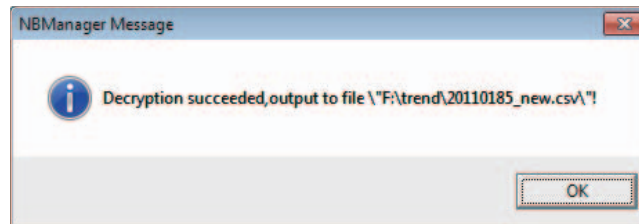

The display effect of the CSV file decrypted successfully is as shown below.

	A	B	C	D	E
1	TIME	CHO			
2	10:57:37	10			
3	10:57:38	20			
4	10:57:39	30			
5	10:57:40	40			
6	10:57:41	50			
7	10:57:42	60			
8	10:57:43	70			
9	10:57:44	80			

- VNC Server

VNC server is used to monitor and operate the display status of the NB Unit from the PC connected through Ethernet. For settings, refer to 3-10-1 PT (Page 3-292).

To use VNC server function, make the connection from the PC with the following settings.

Server: IP Address of the NB Unit

Password: The value set in PT property setting

Port: 5900

This function can be performed in several modes by combining system memories.

Operation mode: Screens can be monitored and operated from remote locations.

To change to operation mode, turn OFF LB9291 and turn ON LB9292 while operating in monitor mode.

Monitor mode: Screens can be only monitored from remote locations, but not operated.

To change to monitor mode, turn ON LB9291 and LB9293 while operating in operation mode.



#### **Additional Information**

---

This function can be enabled or disabled by changing the value of LB9290 on the NB Unit. Operational conflict may occur if a remote operation is attempted while an on-site operation is already being performed. Also, screen, which is not intended by the on-site operator, may appear. For the connection, careful consideration must be given to the on-site situations.

---

## 3-17 RecipeEditor

### ● Description of RecipeEditor Function

RecipeEditor is an Editor attached in the NB-Designer, and it is mainly used for the user to check, edit or create the recipe file conveniently and visually. (The supported formats currently are as follows: files in .rcp format uploaded from or downloaded to NBManager, the specific files in .csv format and the file of FRW memory in .frp format.)

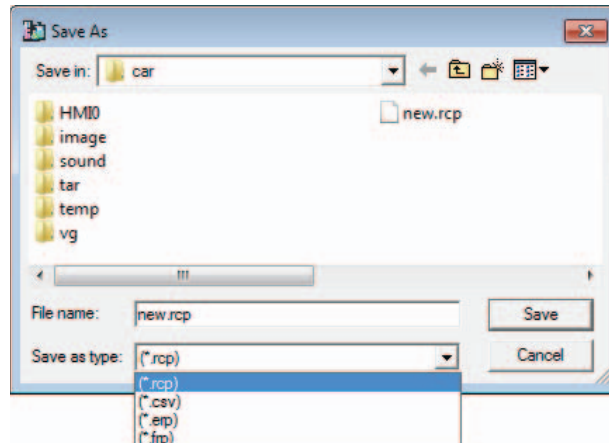

The Recipe Editor supports the functions as below.

The following functions are supported currently:

- (1) Display the data in recipe file.
- (2) Modify the data in recipe file.
- (3) Import the CSV file in specific format, and export the recipe data as the CSV file in specific format.

### ● Method of calling RecipeEditor

- (1) Click Recipe Editor in the Tools menu in NB-Designer software.

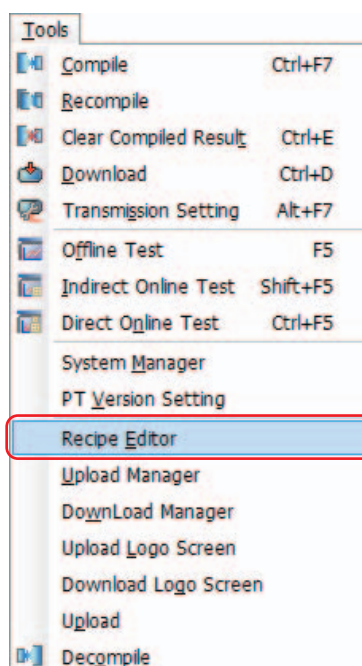

(2) Click [Recipe Editor] in Download Operate tab of NBManager screen.

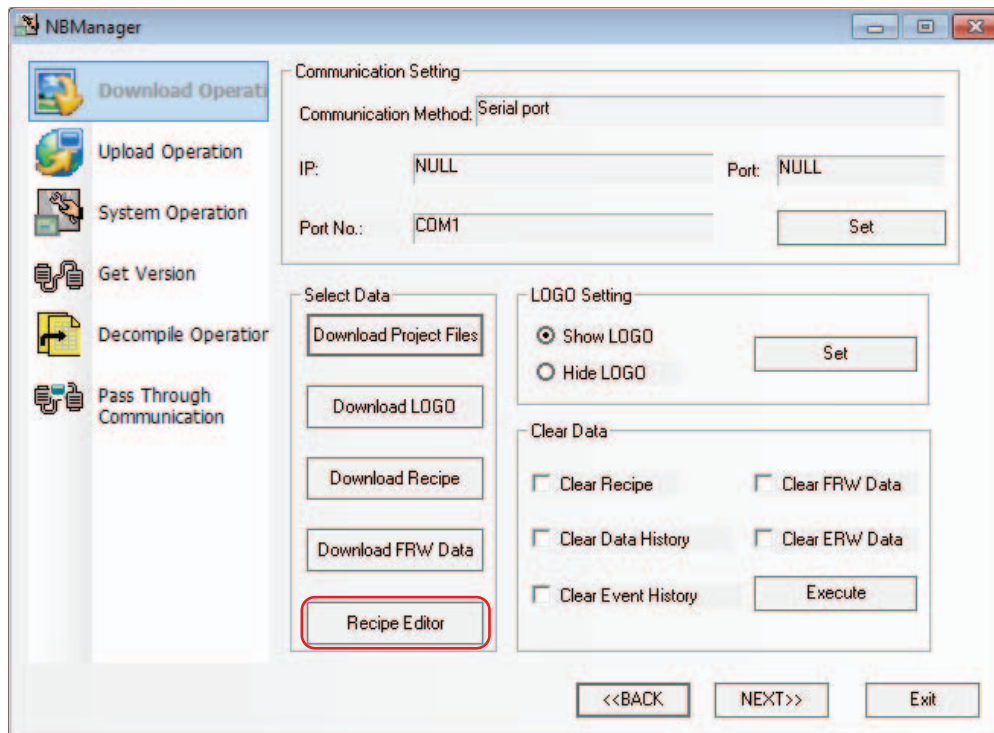

### ● Introduction of RecipeEditor Screen

The screen corresponding to the initial operation of program is as shown below:

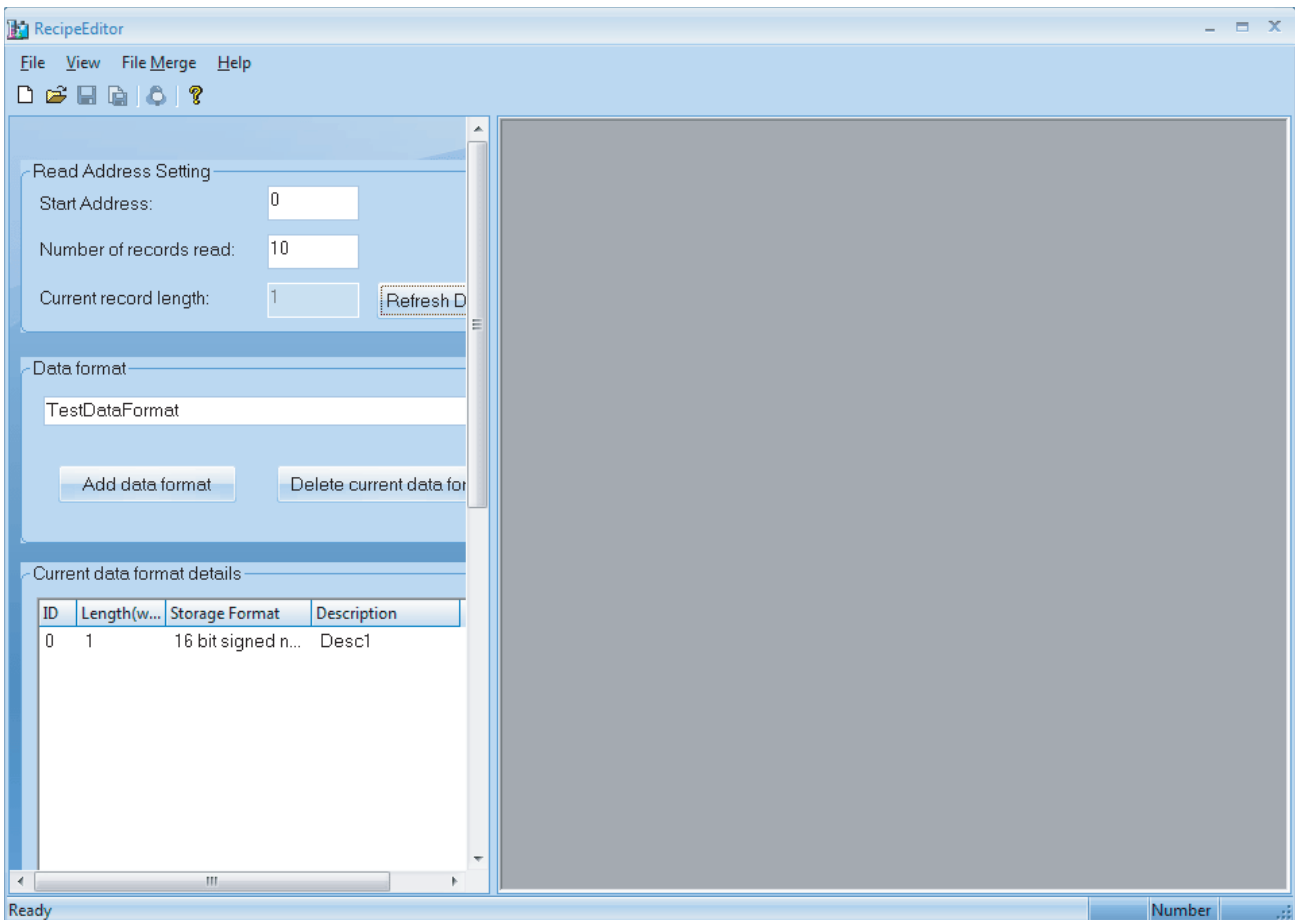

- Toolbar and Menu Bar

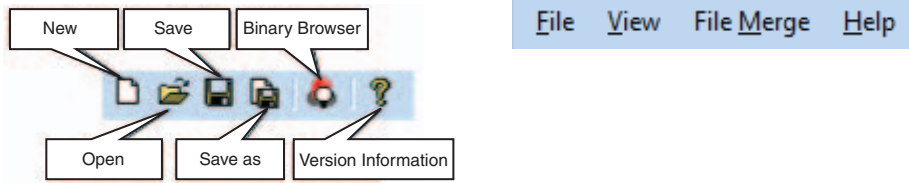

Click New, then the initial screen will pop up as below.

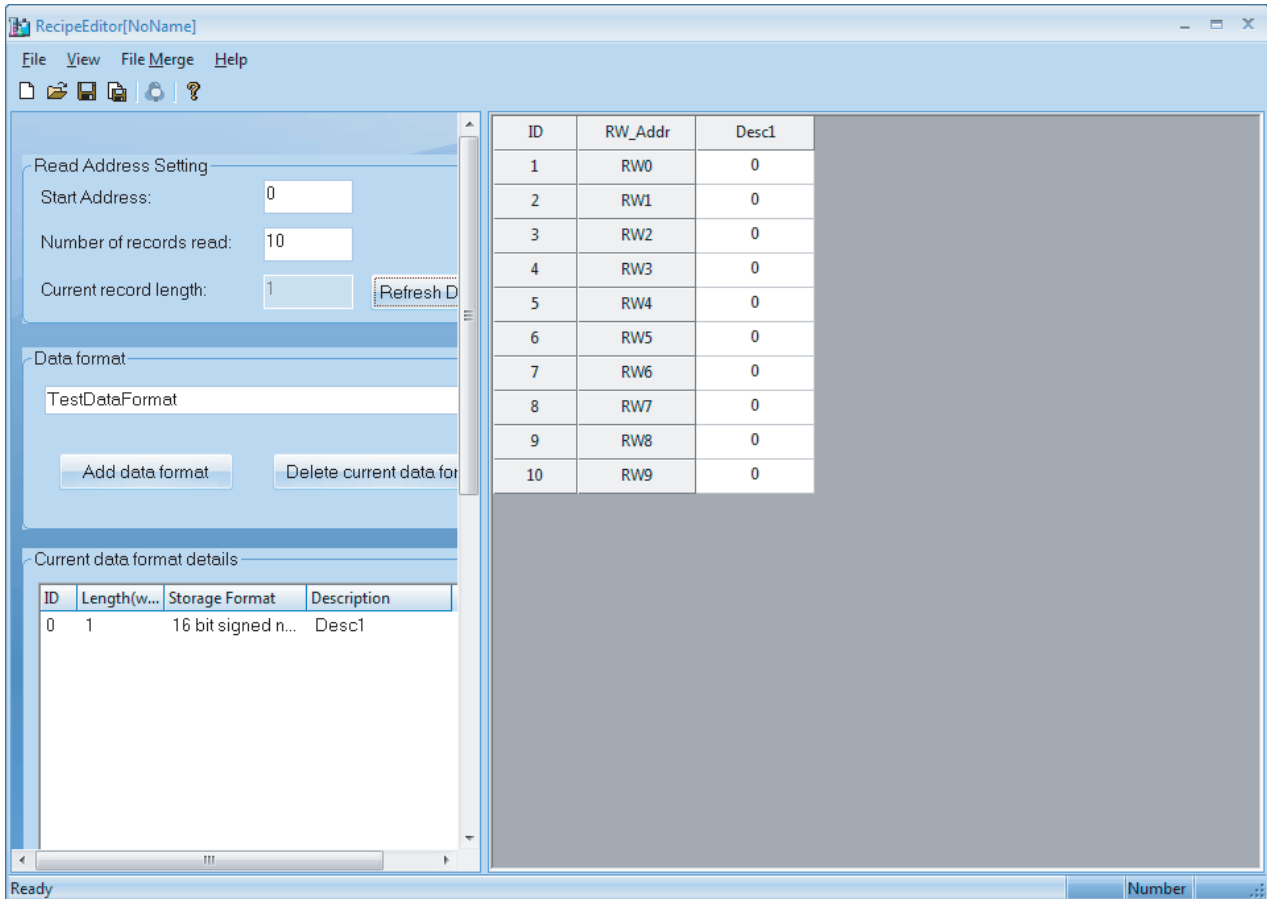

- “Read Address setting” area, “Data Format” area and “Current data format details” area

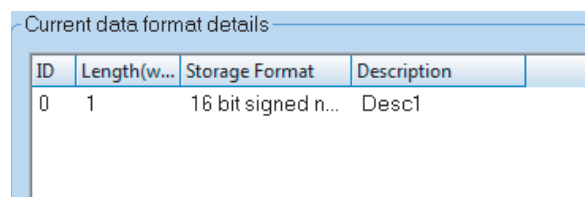
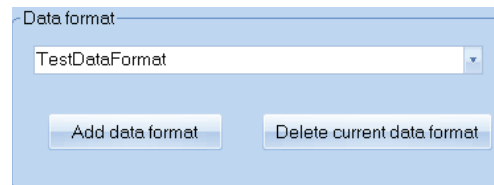
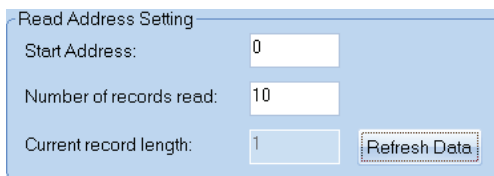



The red frame is the boundary of the setting area and data area, and the former is in the left side while the latter is in the right side. Move the cursor to this boundary and click it, then the setting area will be hidden, and if you click it again, the setting area will appear again.

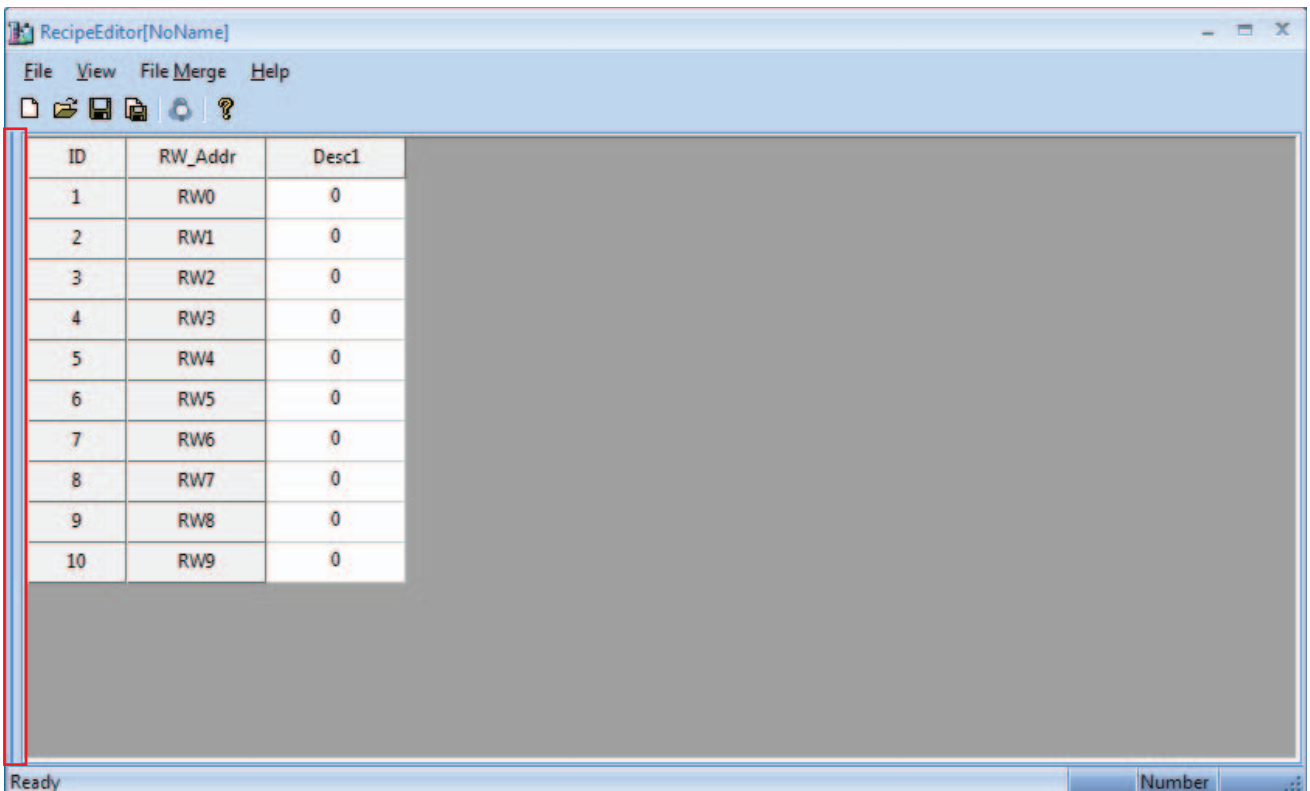
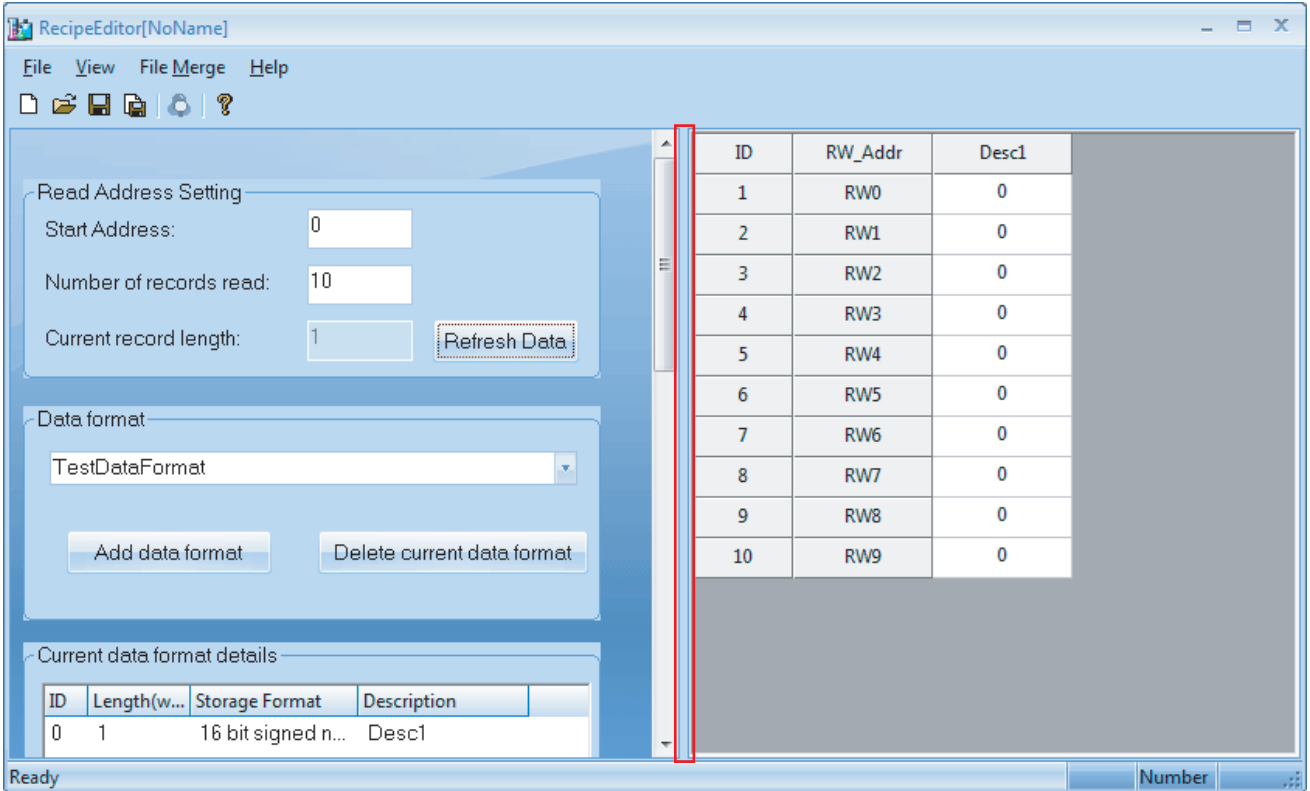

- Input Data in Data Area and Binary Browser

Directly input data in data area and right-click the mouse in the address where the bits to be browsed or click  (Binary Browser) icon to perform the bit browsing with selected the address which should be checked the state of the bit.

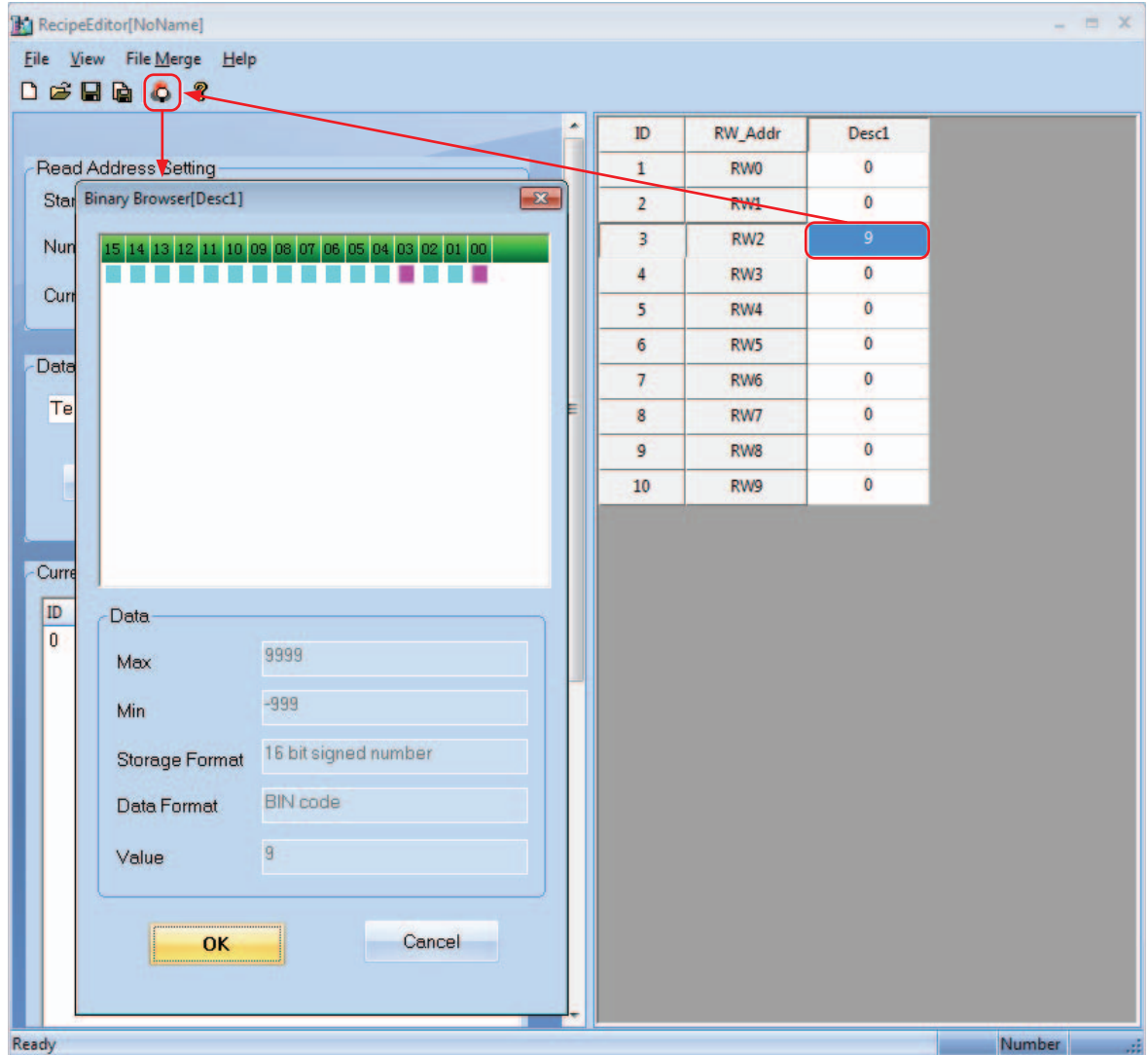

In this case, the value of RW2 is 9, and bit addresses of 03 and 00 indicate the status of ON in binary browser.

● Usage of RecipeEditor

1 Add Data format, Data Type and Adjustment of Data Start Address and Data Length

Procedure of Adding Data Format

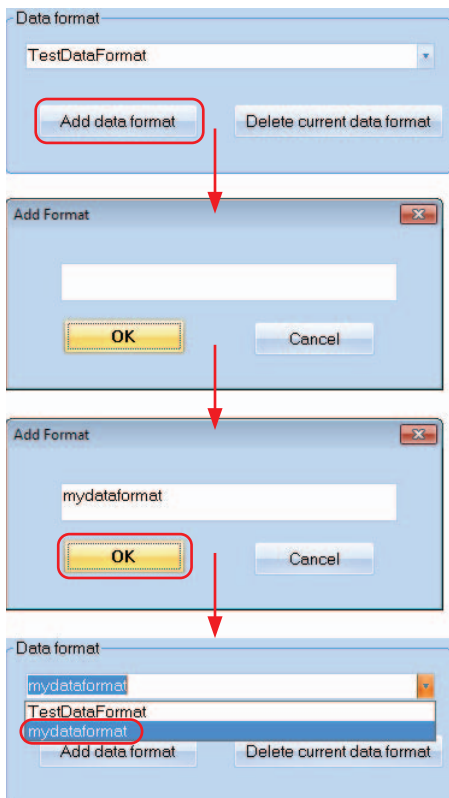

Procedure of Adding Data Type

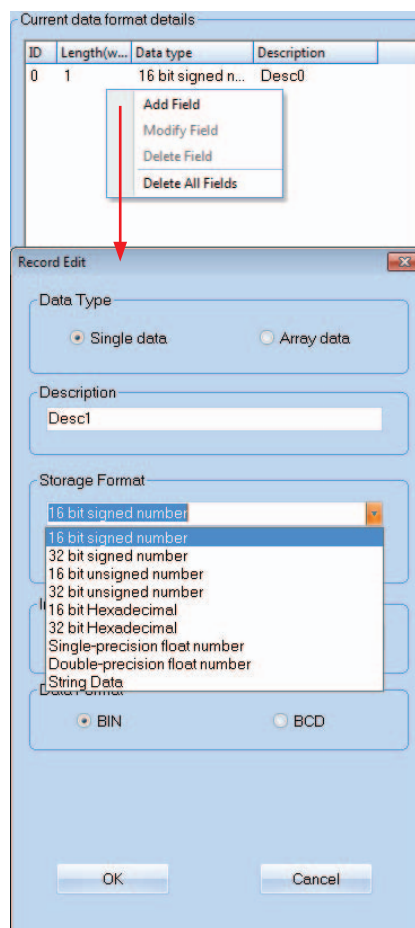

Adjustment of Data Start Address and Data Length

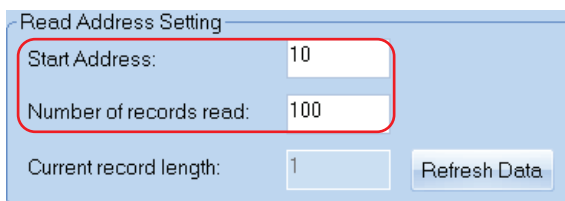

## 2 Creating new Recipe file and Saving the file

When new Recipe file is created, the data type is needed to be specified. When the existing Recipe file is read, the file's specification should be corresponded to the data type specified to the file. If the file is specified the different data type, the contents of the file cannot be read correctly.

The available file format to be edited by Recipe file are .rcp, .frp and .csv.

When RecipeEditor is opened for the first time, clicking  (New) icon will make



displayed in the title bar; while Save As dialog box will pop up if

clicking  (New) icon after the creation of recipe file. Therefore, create another recipe file only after the previous created file is saved. When opening the Recipe file, if [File] - [Open] is selected in the state of the file is already opened, [Save as] dialog box will be opened and [Open file] dialog box will be displayed. For the already saved files, the complete file path will appear in the title bar.



## 3 Data type and changing data

For example, double-click the mouse at the red box during the edition to make the Record Edit Dialog pop up, and then change Storage Format from “16 bit signed number” as the lower left graphics shown to “16 bit Hexadecimal” as the lower right graphics shown.

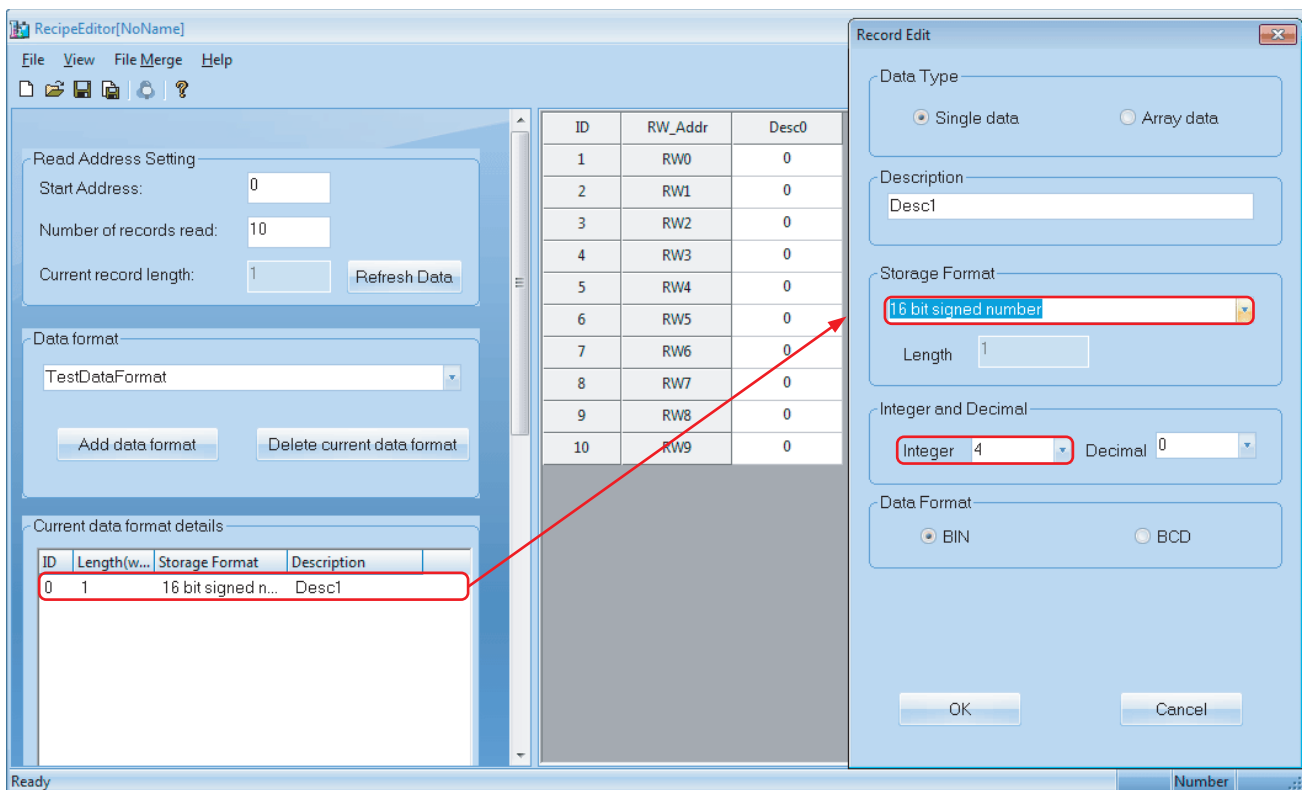

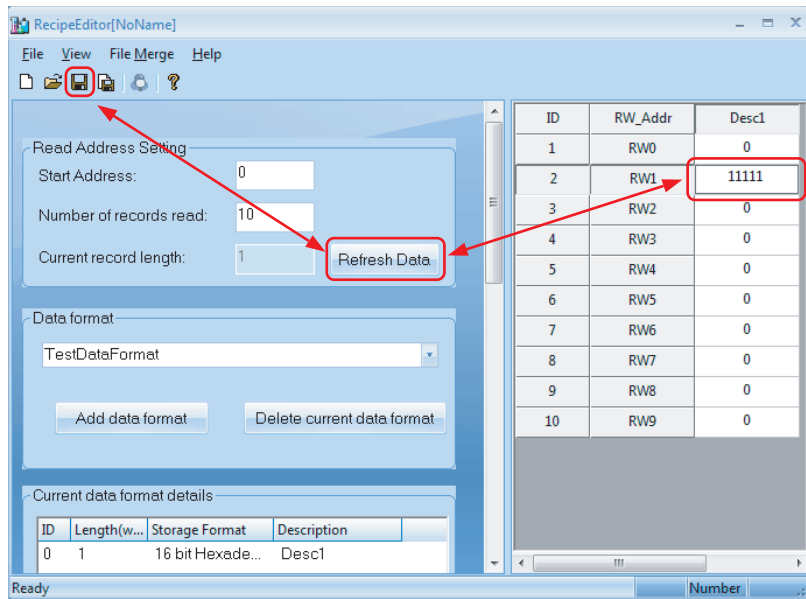
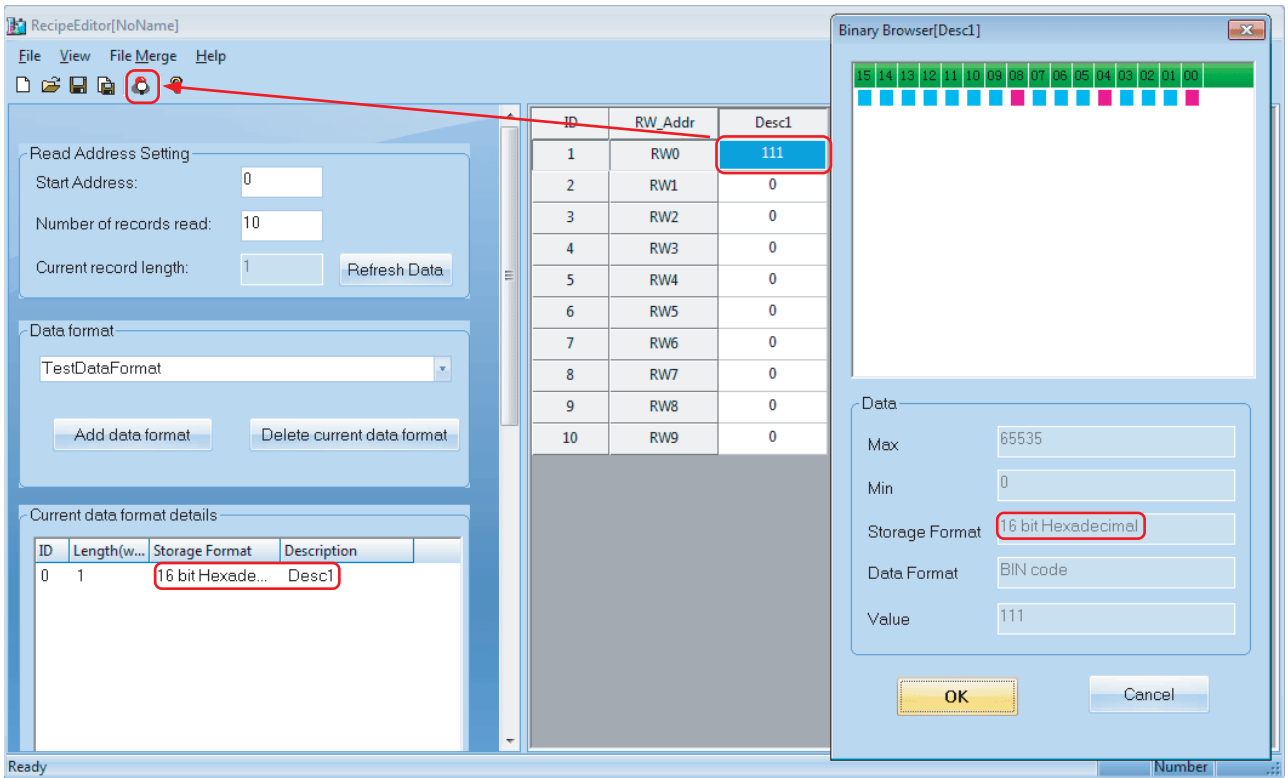

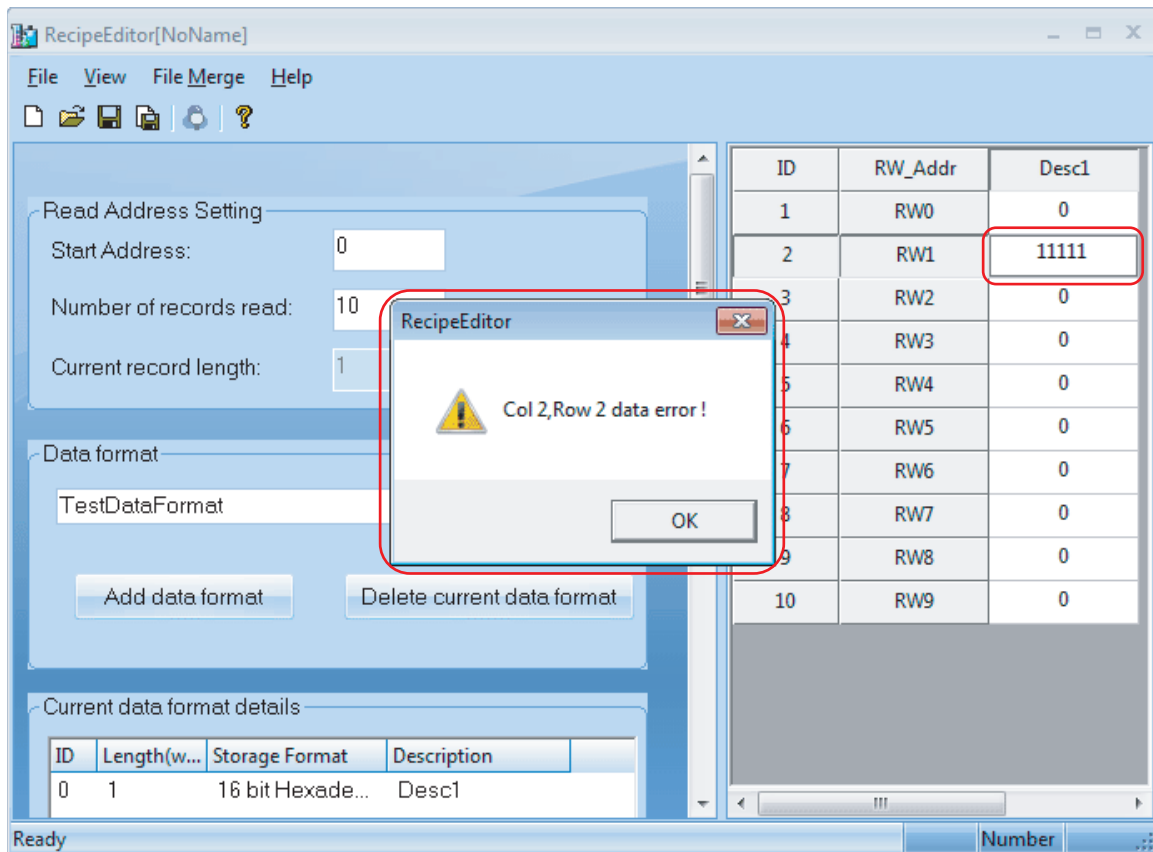

After the completion of number input, it would better to have the Enter key pressed, and it must be saved.

If the file is not saved and click the [Update Data] button, the data which was entered before clicking the button will be lost.

The value exceeds the data type and range of digits cannot be input.

#### 4 Single data and Array data.

The data shown in the previous case is single data, i.e. a group of data. Provide a brief of array data. Array data, i.e. the data belonging to the same classification is placed together, which is helpful to the data edition, as shown below:

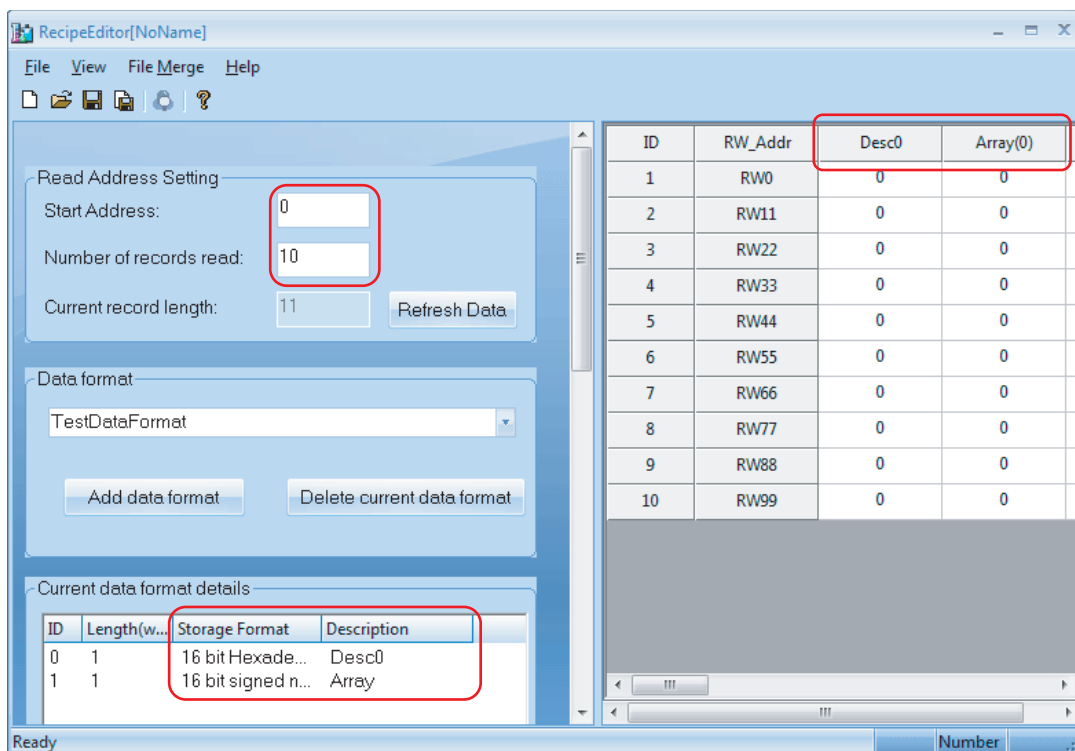
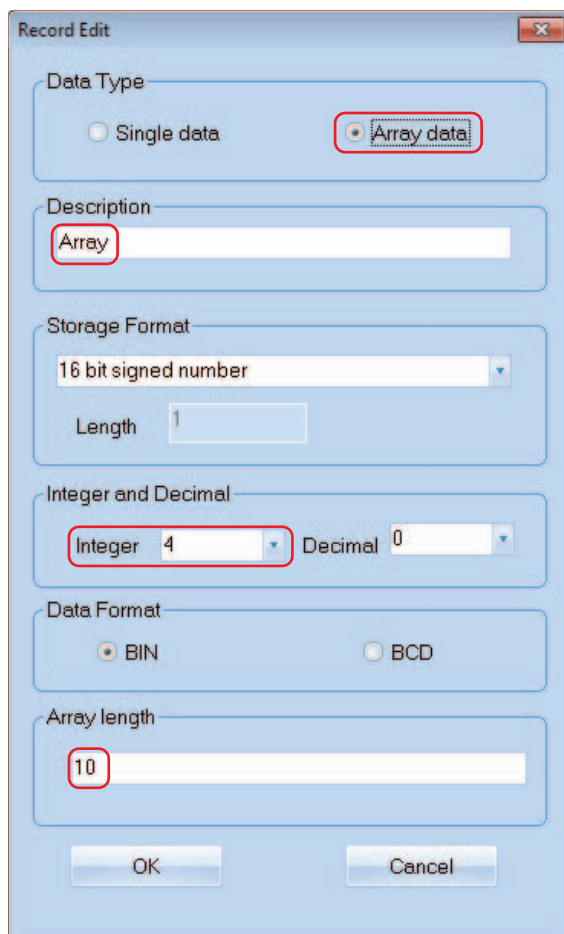

**5** File Merge Function.

File merge function is mainly applicable to the 2 recipe files with the different recipe addresses. These 2 recipe files can be merged into 1 file after they are edited separately, then the 1 merged file can be downloaded into PT, as the lower left graphics shown:

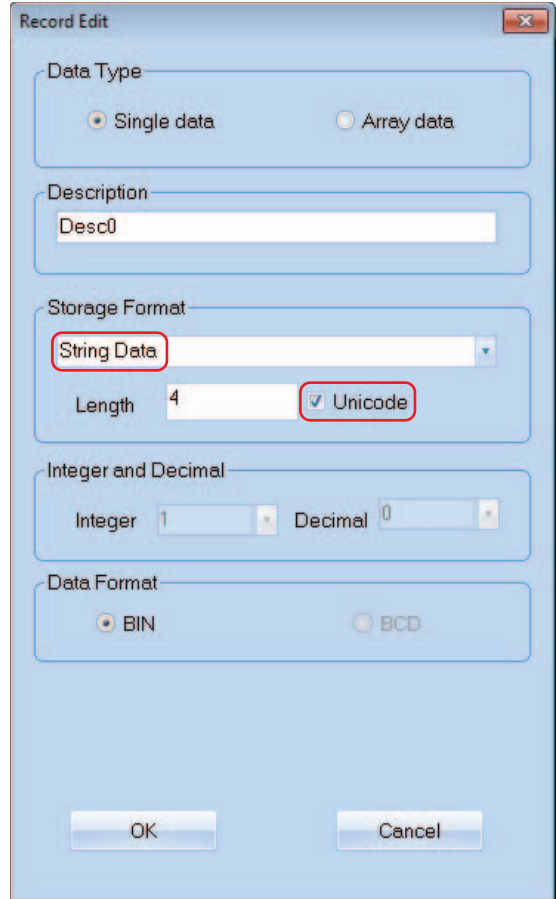
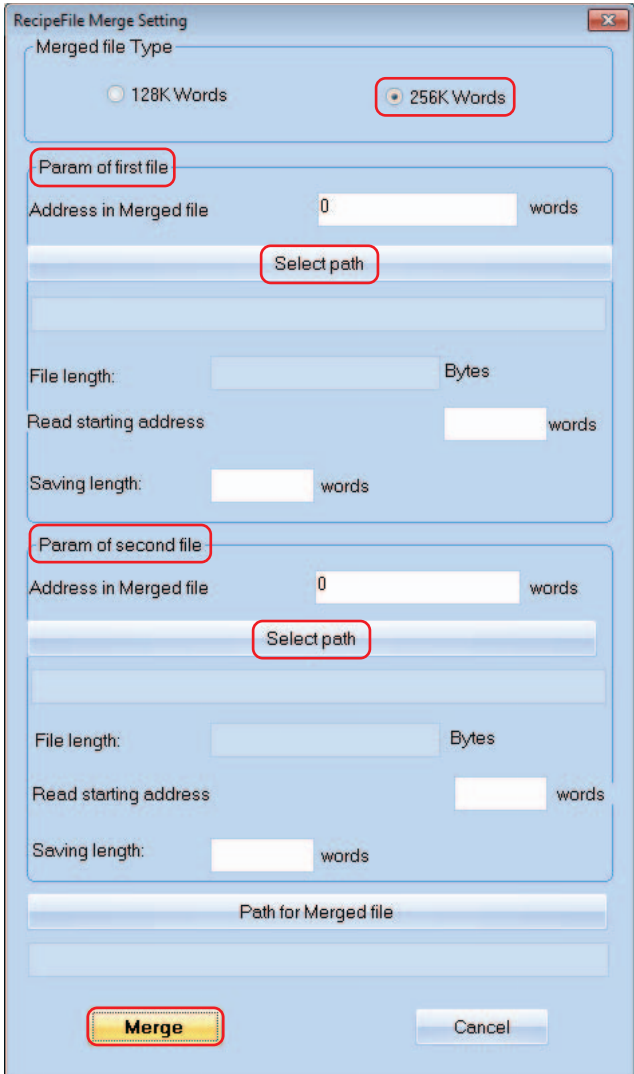

**6** Unicode can be checked for String Data.

As the above right graphics shown, Unicode can be checked for String Data.



## 7 Part of data type supports Binary Browser

Binary Browser is one special function provided by RecipeEditor, which is convenient for the user to check the data which is shown as “Supported”, as shown below:

Data Type	Supported or Not
16 bit signed number	Supported
32 bit signed number	Supported
16 bit unsigned number	Supported
32 bit unsigned number	Supported
16 bit Hexadecimal	Supported
32 bit Hexadecimal	Supported
Single-precision float number	Not supported
Double-precision float number	Not supported
String Data	Not supported

### ● 3 Data Types (.rcp, .frp and .csv)

#### .rcp format

This is the recipe file format which can be identified by PT. The recipe file in this format can be uploaded or downloaded with NBManager. (The size of this file is limited by the recipe memory in PT device.)

#### .frp format

This is the file format to be stored in flash memory of PT.

#### .csv format

The data can be edited by Excel.

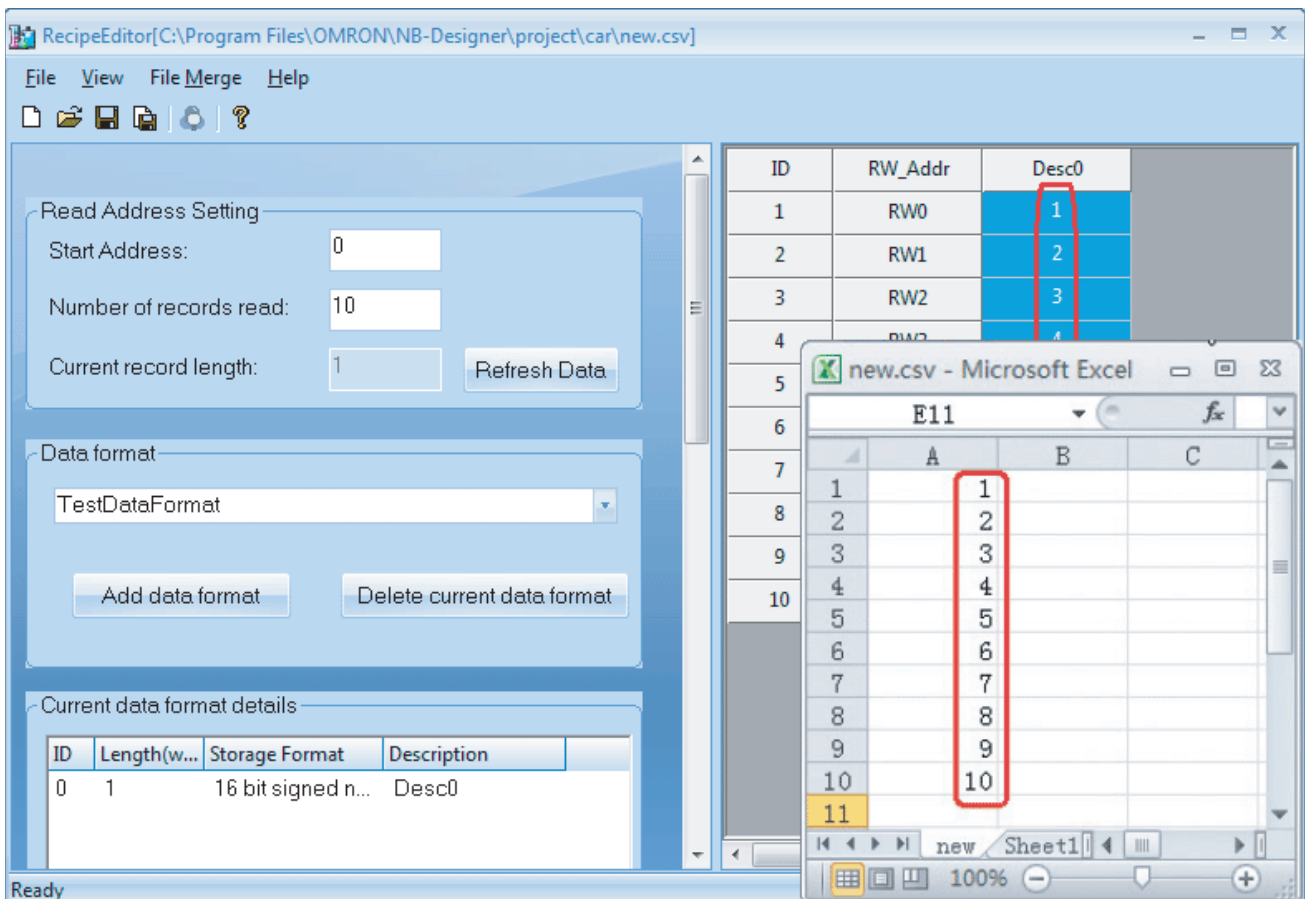



# 4

## Functions of NBManager

This section describes the NBManager.

---

<b>4-1</b>	<b>Introduction of NBManager</b>	<b>4-2</b>
<b>4-2</b>	<b>Download Operation</b>	<b>4-3</b>
4-2-1	Communication Setting	4-3
4-2-2	Select Data	4-6
4-2-3	LOGO Setting	4-9
4-2-4	Clear Data	4-10
<b>4-3</b>	<b>Upload Operation</b>	<b>4-12</b>
<b>4-4</b>	<b>System Operation</b>	<b>4-15</b>
<b>4-5</b>	<b>Get Version</b>	<b>4-16</b>
<b>4-6</b>	<b>Decompile Operation</b>	<b>4-17</b>
<b>4-7</b>	<b>Web Interface Operation</b>	<b>4-18</b>

## 4-1 Introduction of NBManager

NBManager is a tool managing the whole NB-Designer software, which includes 6 operates, i.e. Download Operation, Upload Operation, System Operation, Get Version, Decompile Operation and Pass Through Communication.

Clicking [Start]-[All Programs]-[OMRON]-[NB-Designer]-[Tools]-[NBManager] will make NBManager dialog box pop up, as shown below. Double-clicking the shortcut icon () on desktop also allows the NBManager to start.

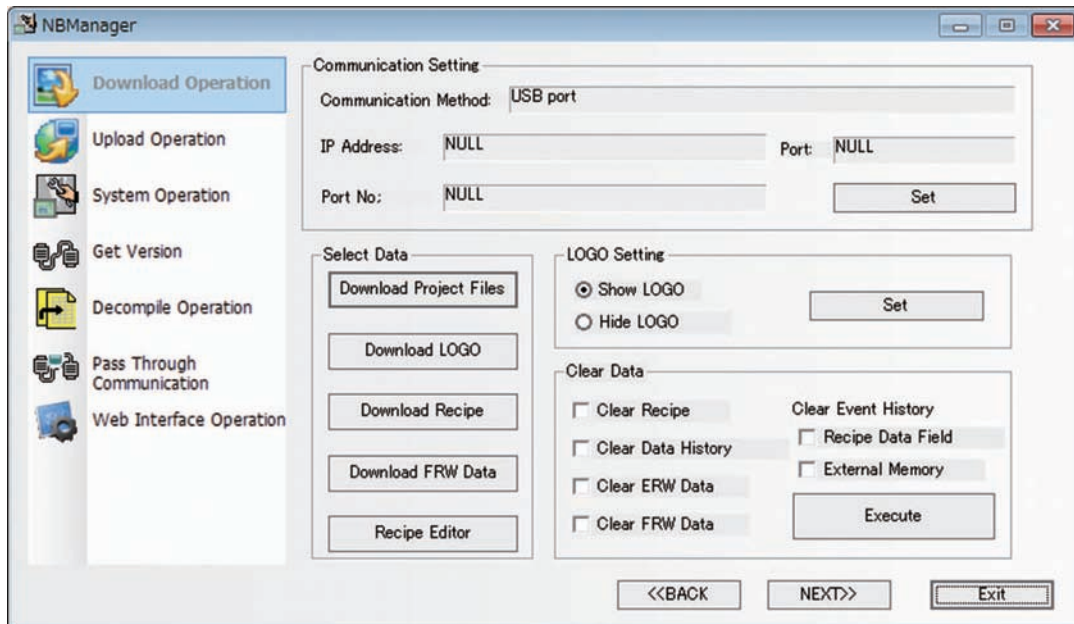

## 4-2 Download Operation

Download Operation is mainly used for the download from PC to PT.

The Communication Setting must be set before the download.

### 4-2-1 Communication Setting

The setting of Communication Setting is the same with the settings of project options in the edit window. For details, refer to 3-15 Download (Page 3-362) in *NB-Designer Operation*.

#### ● Communication Setting

- The Communications Type with Serial Port

Click the [Set] button and select [Serial Port] and the Serial Port of your PC from [Serial No.] in the popup [Communication Setting] dialog box, then click the [OK] button. This function cannot be used on models that do not support a serial port.

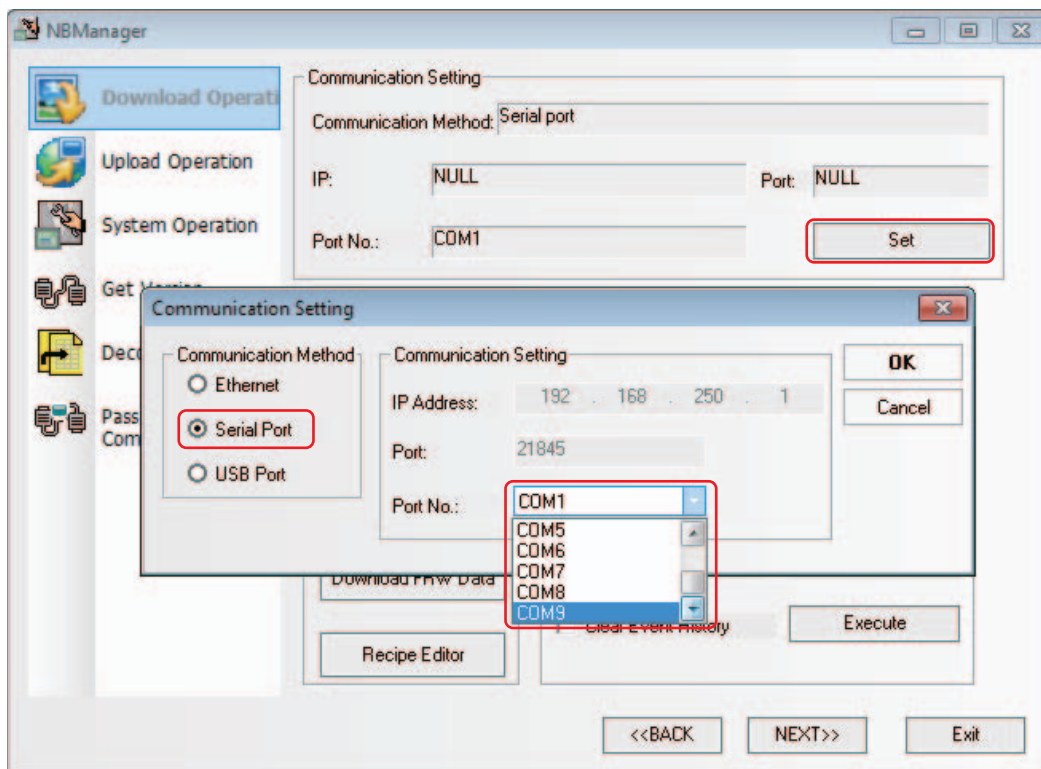

- The Communications Type with USB

USB Port is the system default type. If you use the USB to perform the download, it doesn't need to make settings again.

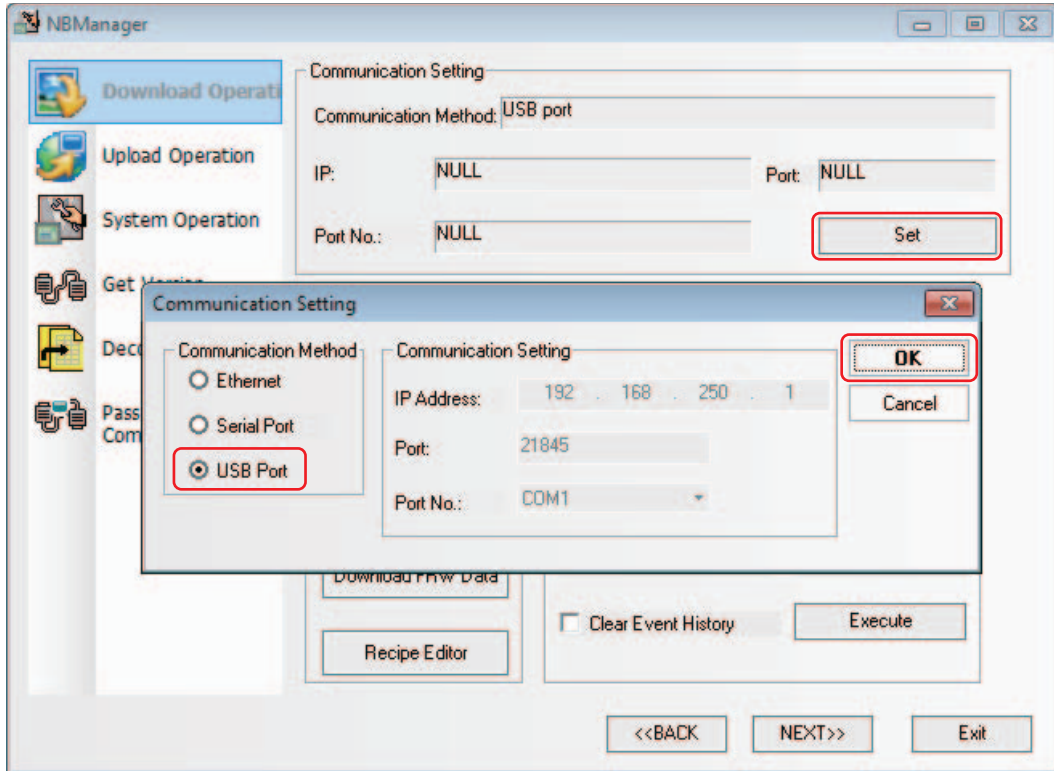

- The Communications Type with Ethernet

- Settings for using Ethernet

In the [NBManager] dialog box, click the [Set] button in the [Communication Setting] option, and then check the [Ethernet] in Communication Method option in the Communication Setting dialog box with the various parameters same as that of PT Unit. At the same time, set the IP address of PC to the same network segment as that for PT Unit, as shown below:

These functions cannot be used on models that do not support an Ethernet port.

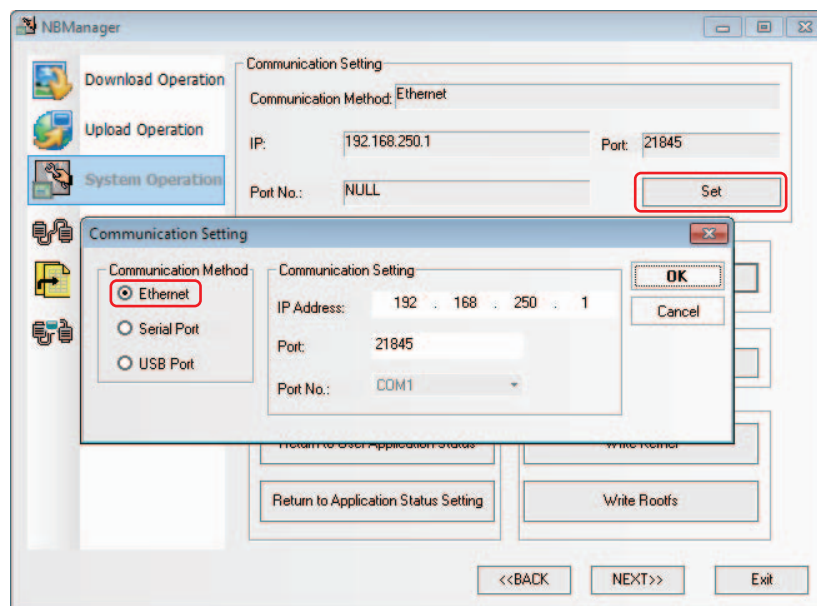

- Setting and obtaining IP address and Port  
In the [NBManager] dialog box, click the [System Operate].

The screenshot shows the NBManager dialog box with two main sections for IP and port configuration, and two sections for returning or writing settings.

**Get IP Address/Port of PT**  
IP: [ . . . ] Port: [ ] [Get]

**Set IP Address/Port**  
IP: [ . . . ] Port: 21845 [Set]

**Return Setting**  
Return to User Application Status  
Return to Application Status Setting

**Write Setting**  
Write Kernel  
Write Rootfs

Get IP Address/Port of PT	Obtain IP address and port number of PT.
Set IP Address/Port of PT	Modify the IP address and Port of PT to the parameters which were set to [IP] and [Port]. (IP Address/Port can be updated only when the connection is realized via USB port or serial port.)

After setting of the Communication Setting, move to the settings of Select Data.

## 4-2-2 Select Data

The operation is the same as the one of edit window. For details, refer to *3-15 Download (Page 3-362)* in *NB-Designer Operation*.

Download Project Files: Refers to download the edited project files (\*.pkg) to the PT.

Click the [Download Project Files] button:

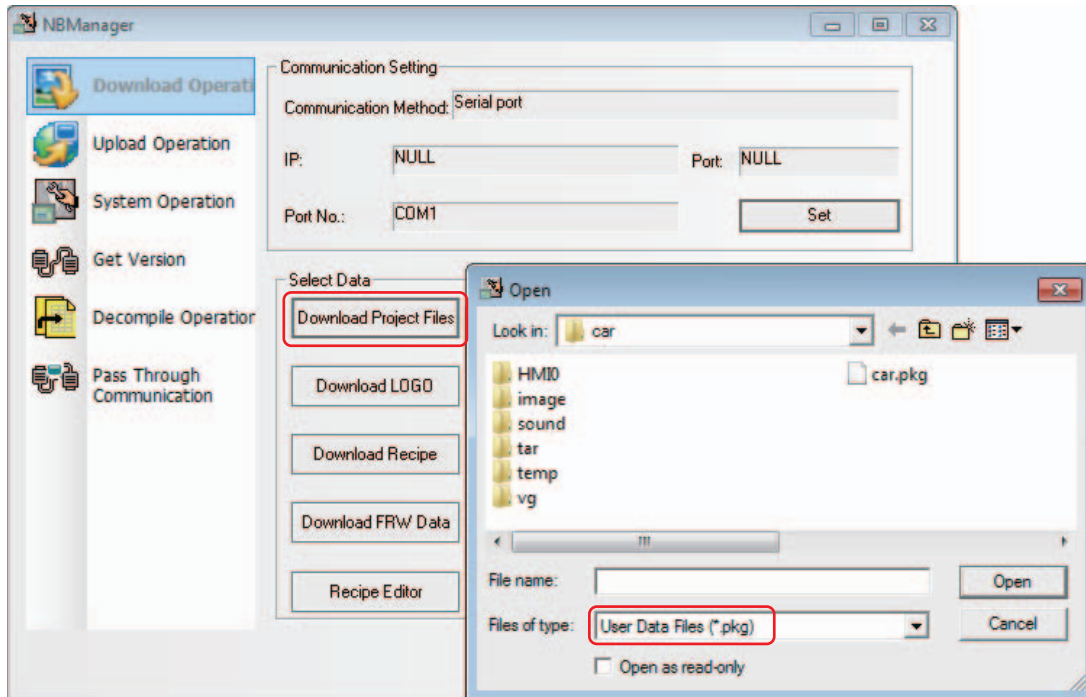

Select the generated \*.pkg file after compiling the edited project file, then click the [Open] button to make the following dialog box pop up.

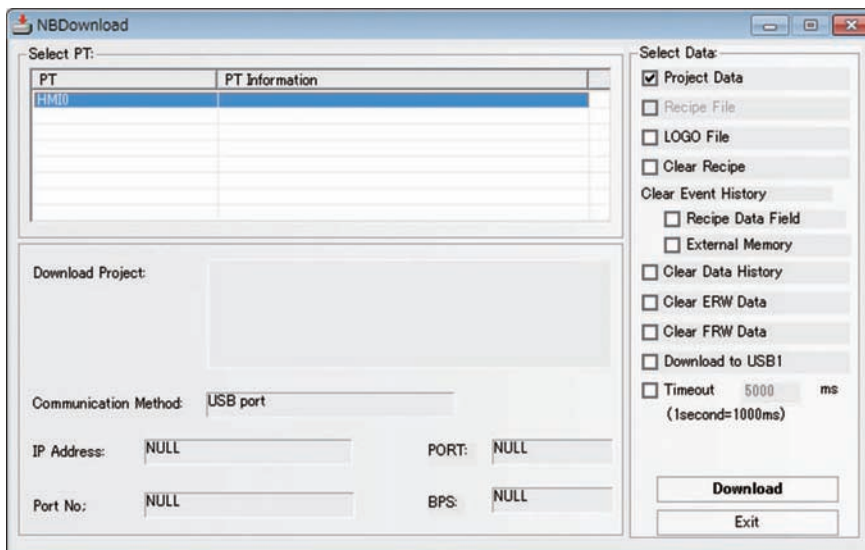

If there are several PTs in your project, firstly select the No. corresponding to the destination PT to be downloaded, and then click the [Download] button.



### ● Download Recipe

Firstly, click the [Download Recipe] button and select the pre-edited file with the suffix of “.rcp”, then click the [Open] button to perform the download.

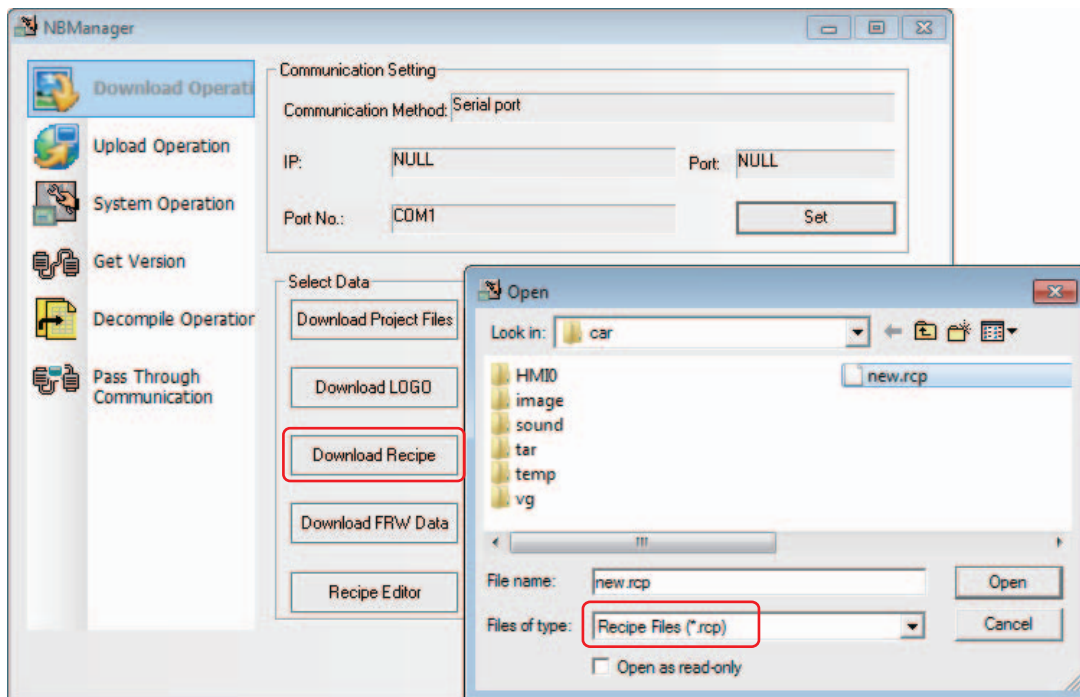

### ● Download LOGO

Click the [Download LOGO] button and select the edited project, i.e. the file with the suffix of “.logo” in PT folder under “car” folder, and then click the [Open] button to perform the download.

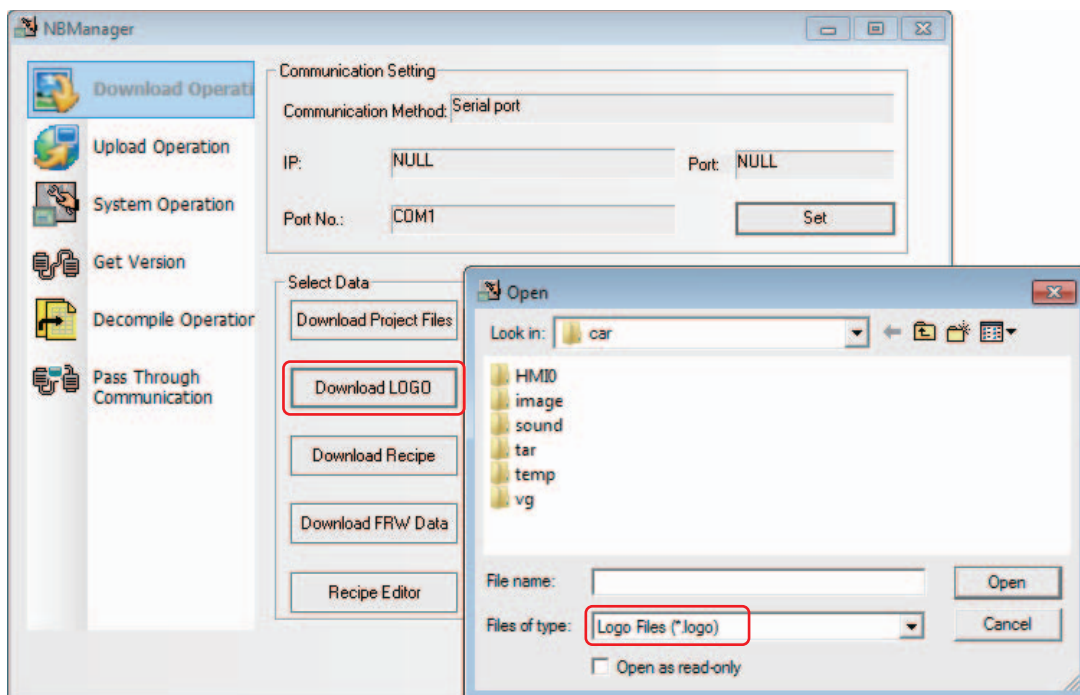

● **Download FRW Data**

Click the [Download FRW Data] button and select the edited project, i.e. the file with the suffix of “\*.frp” in PT folder under “car” folder, and then click the [Open] button to perform the download.

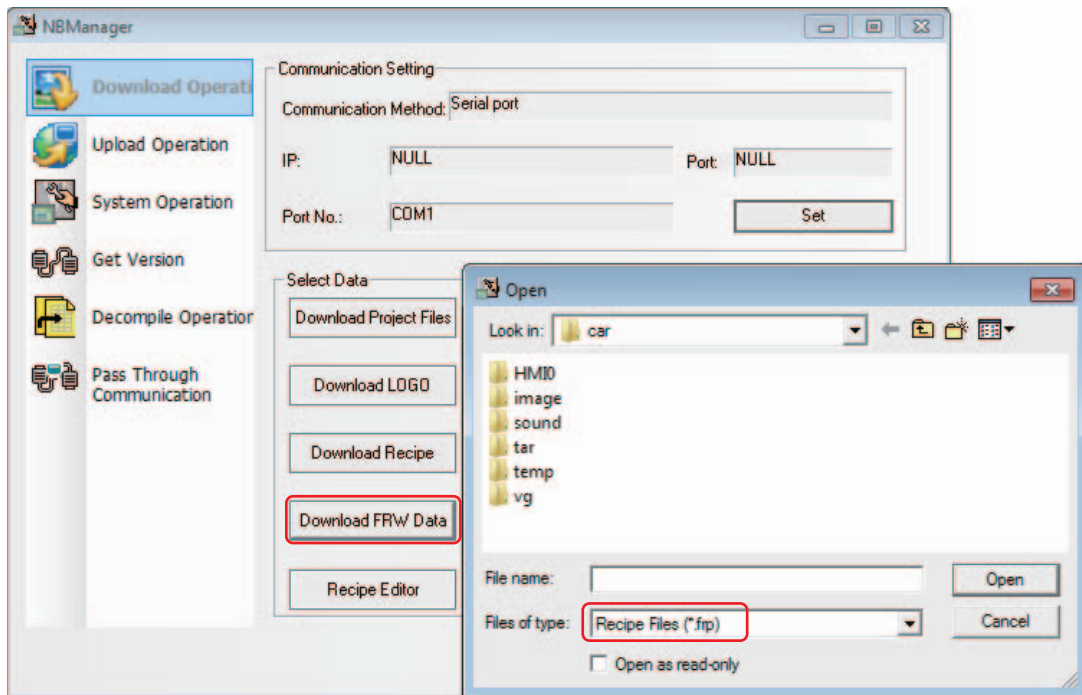

● **Recipe Editor**

Clicking the [Recipe Editor] button will open the RecipeEditor.

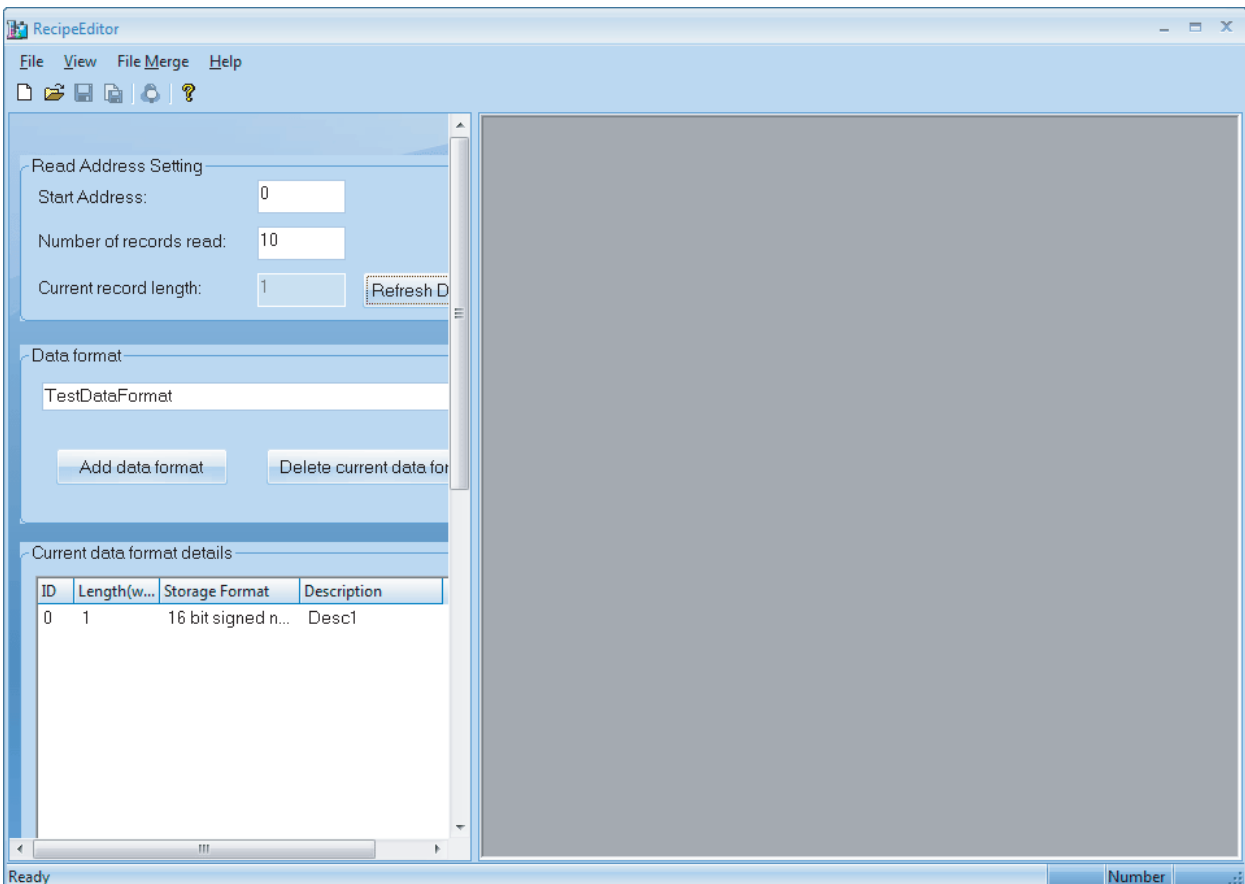

### 4-2-3 LOGO Setting

It is used to set the display of LOGO screen at the PT startup.

#### ● Show LOGO

The specific operation is as follows: Select [Show LOGO] and click the [Set] button as shown below. If the setting is successful, [Set Successfully] dialog box will appear. Once the setting is successful, The transferred LOGO screen will be displayed at the next startup of PT.

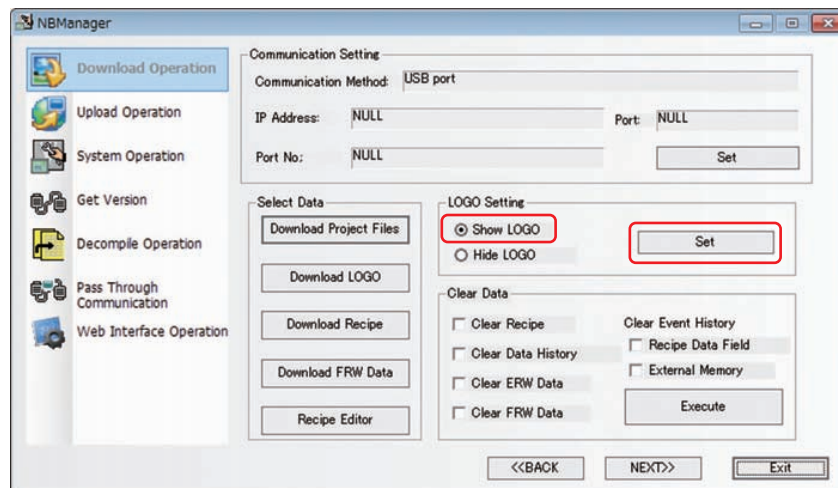

If the setting is failed, please modify the Communication Setting again after the “Error occurs” dialog box pops up.

#### ● Hide LOGO

The specific operations are as follows: Select [Hide LOGO] and click the [Set] button as shown below. If the setting is successful, [Set Successfully] dialog box will appear. Once the setting is successful, LOGO screen will not appear during the startup of PT next time.

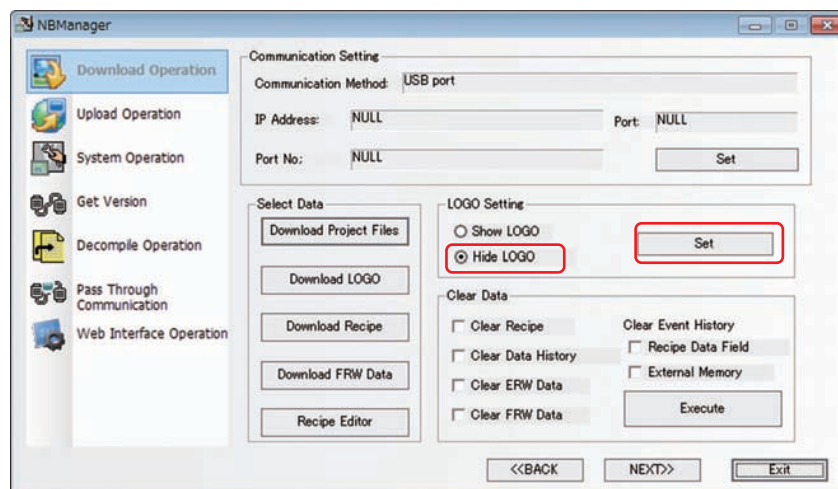

If the setting is failed, please modify the Communication Setting again after the “Error occurs” dialog box pops up.

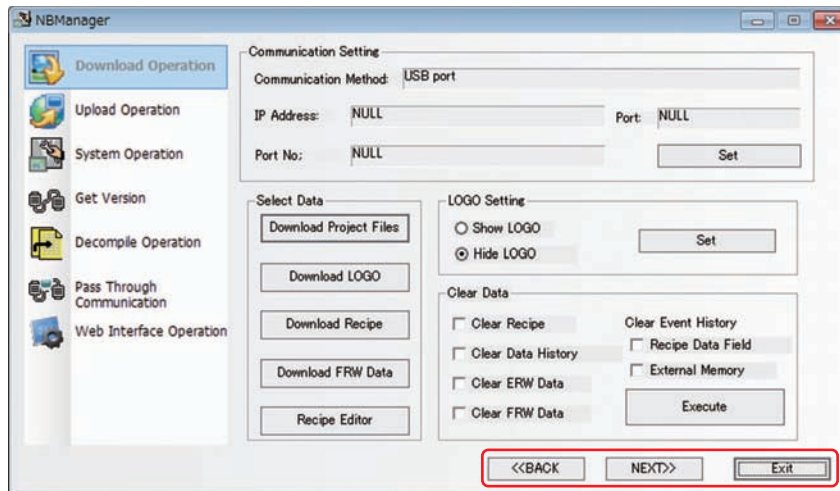

Clicking the [BACK] and [Next] buttons can make switching among the Download Operate, Upload Operate, System Operate, Get Version, Decompile Operate and Pass Through Communication.

Click the [Exit] button to exit from the NBManager.

### 4-2-4 Clear Data

The option in Clear Data are consistent with the corresponding options in “Select Section” of NB-Designer. After checking the required options, press the [Execute] button.

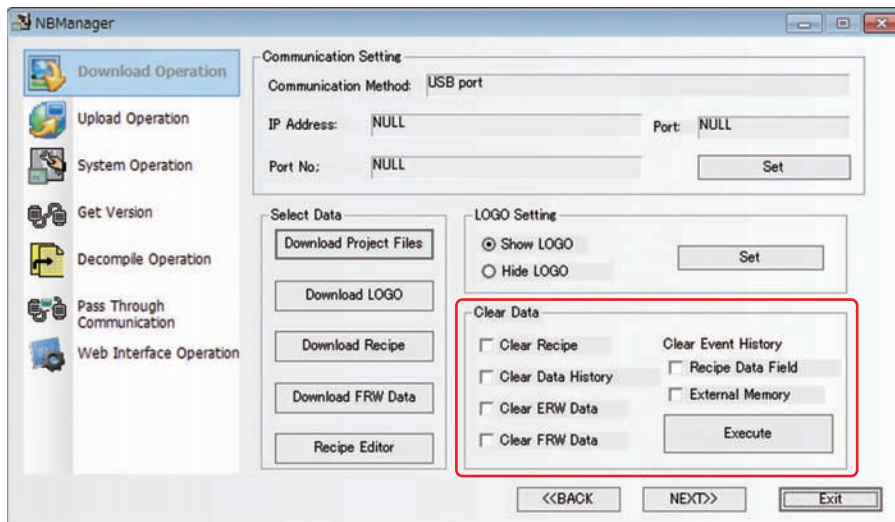

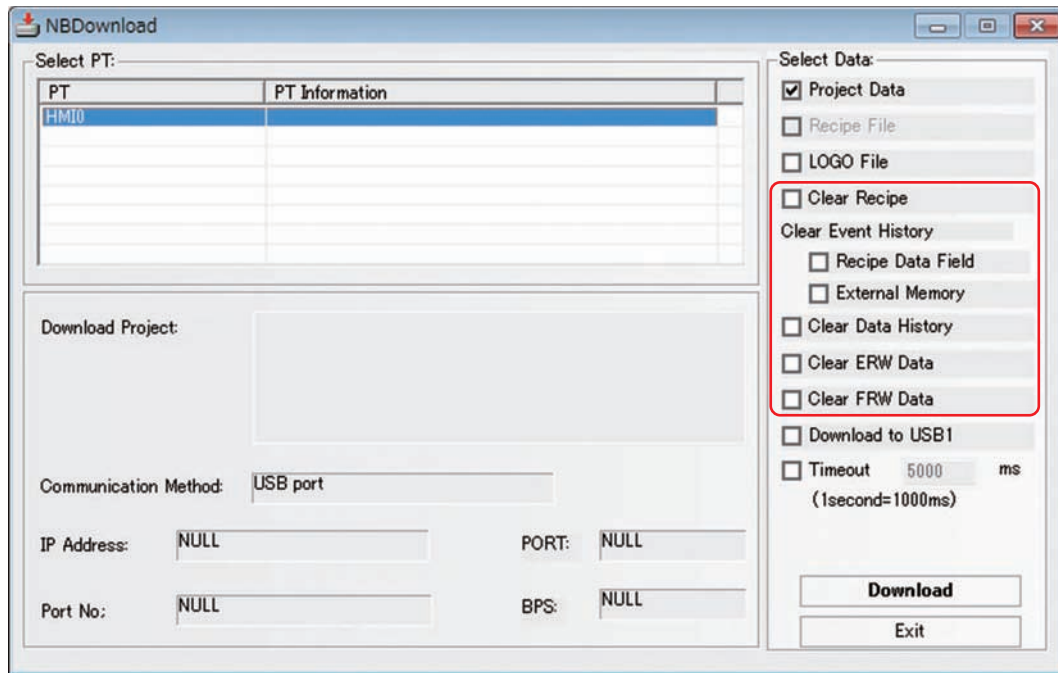

**Note** Because the NB-S series does not support external memory, functions related to external memory cannot be used.

## 4-3 Upload Operation

Upload Operate is mainly used for the file upload from PT to PC.

The communication parameters must be set before the upload.

The Communication Setting is same as that of download.

Select Data:

Upload Project Files:

Enter descriptions to [PT Information], if necessary.

Firstly check [Project Data (required)] and click the [OK] button to select the path for saving the data, then click the [Save] button after inputting the file name.

After the [Password(Upload)] pops up, input 888888 and press the OK button to perform the upload.

**Note** The default password for upload is 888888.

If you want to modify the upload password, please double-click the PT in Project Work Space and modify [Password] corresponding to "Allow Upload" in [PT Extended Properties] tab.

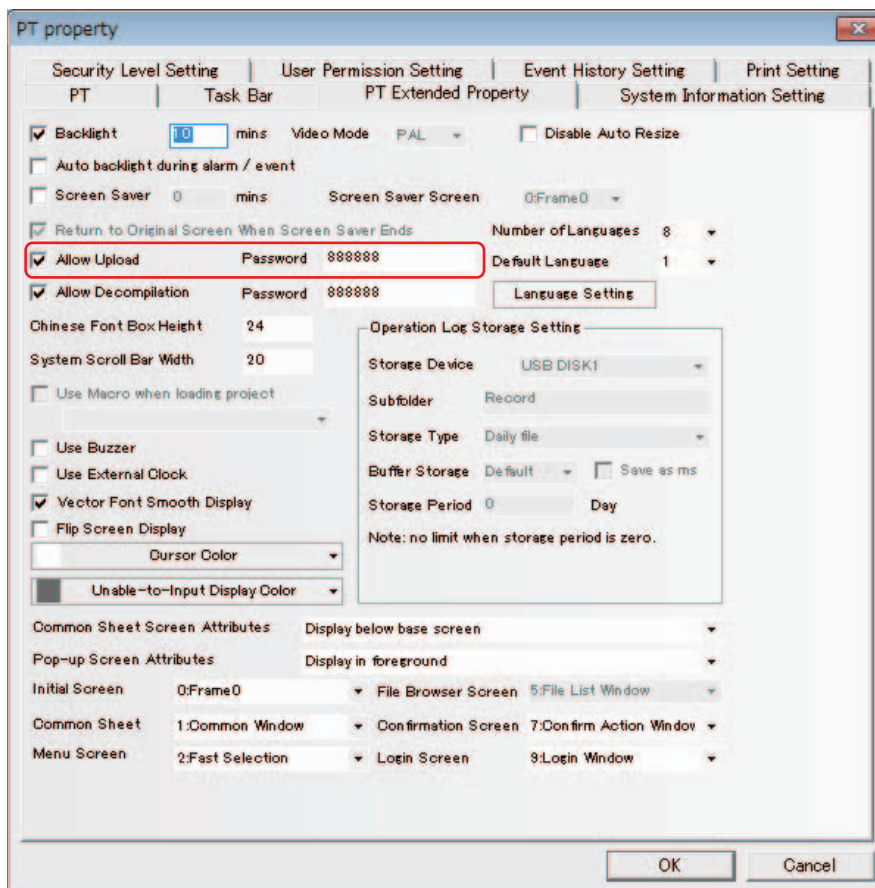

When Logo file and recipe file need to be uploaded, you can check “Logo File” and “Recipe File”.

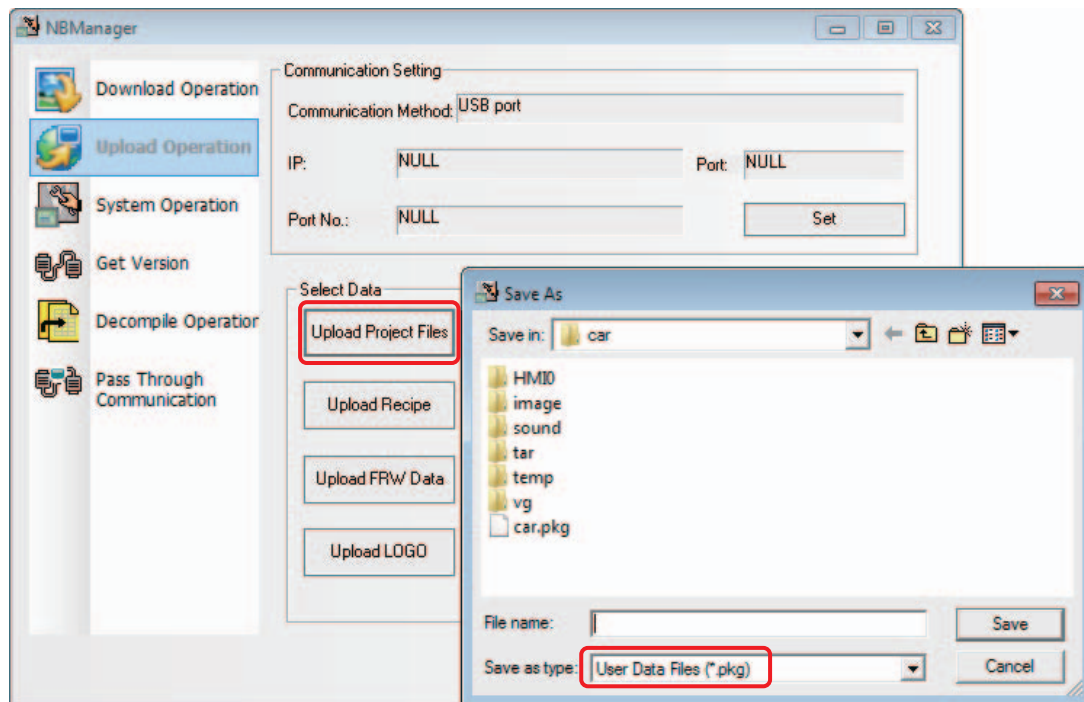
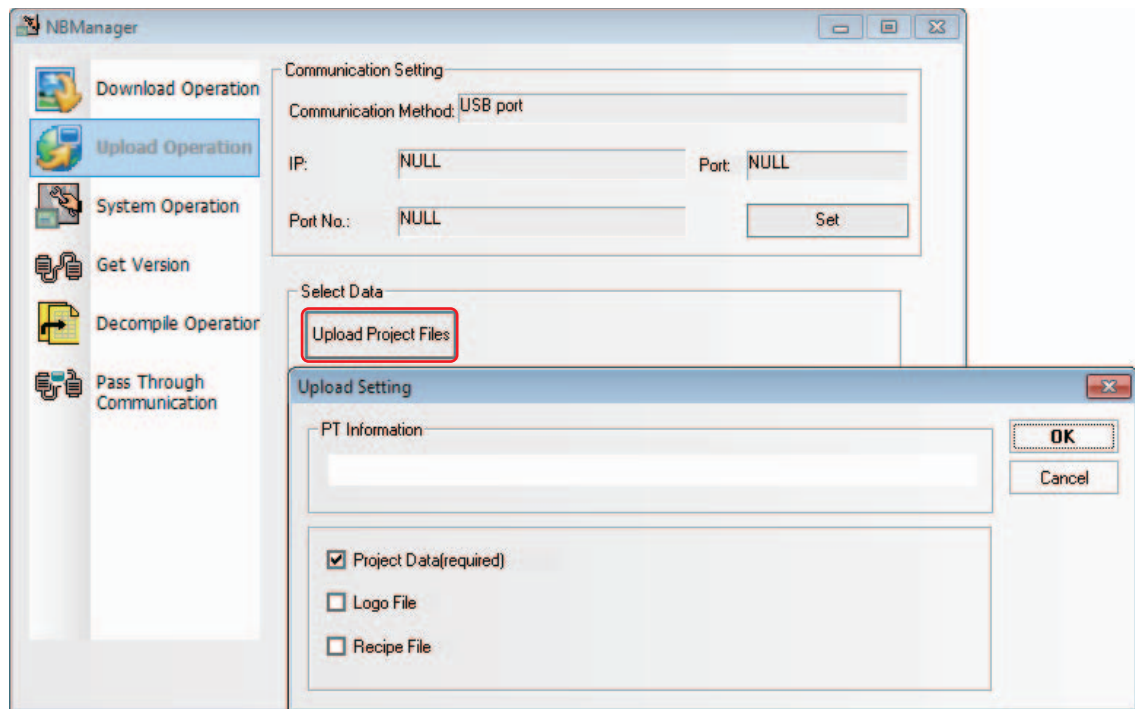

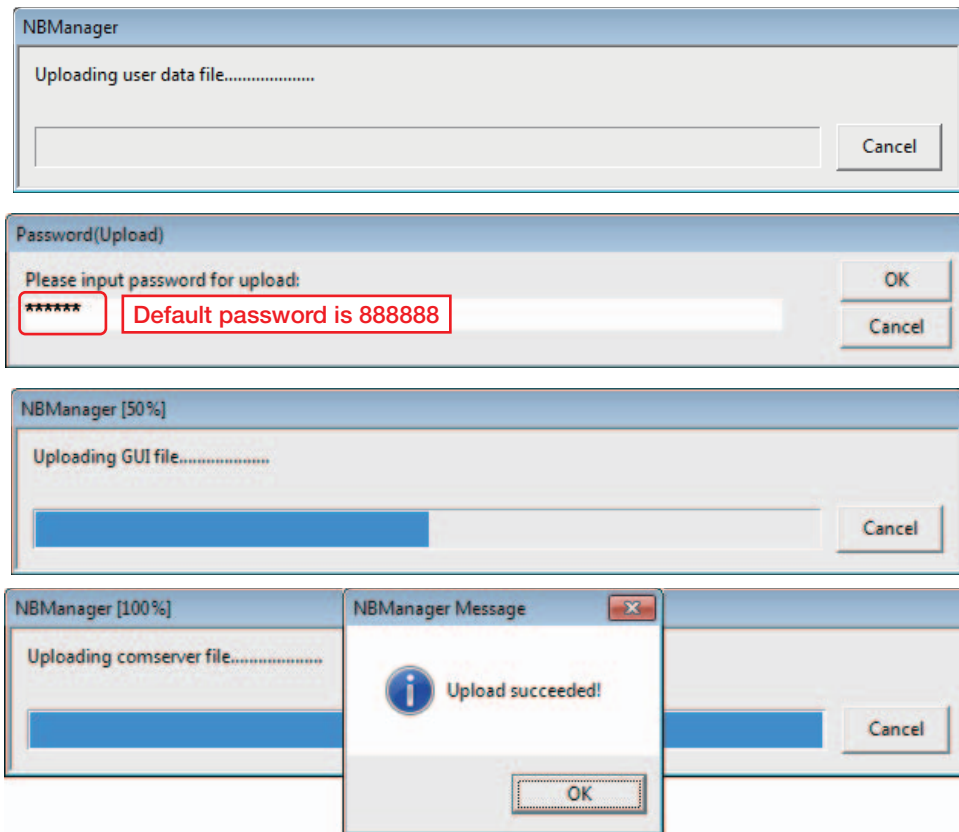

Select [Upload Recipe] and select the path to save the recipe, and then click the [Save] button after the file name is input.

Select [Upload LOGO] and select the path to save the LOGO, then click the [Save] button after the file name is input.

Select [Upload FRW] and select the path to save the FRW, and then click the [Save] button after the File name is input.

The file name and the path saved during the upload can be selected by the user freely.



## 4-4 System Operation

### Mode Settings:

When executing user projects: Specify the destination PT to the User Project Mode.

When executing system settings: Specify the destination PT to the System Setting Mode.

### Operating Update:

Update Kernel and Rootfs. Change to Downloader Mode before the update. Refer to 3-1 Display Method of System Setting Mode (Page 3-2) in PT Setup.

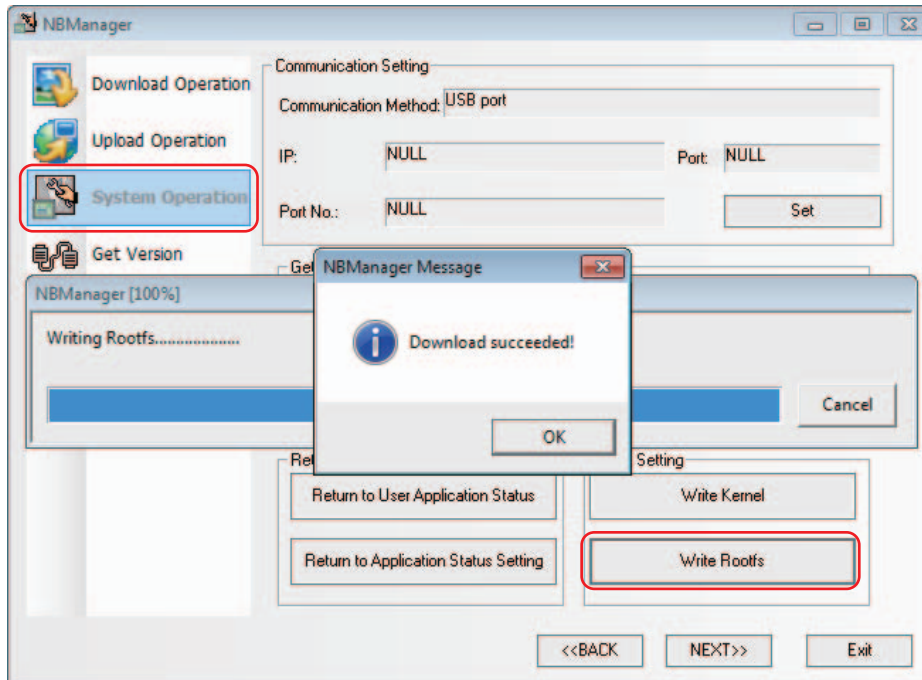

**Note** After the updates of the Kernel and Rootfs, the NB unit settings will return to the factory settings and the screen data will be removed. Note that point when you perform the operation.

## 4-5 Get Version

- **Get Version:**

Clicking the [Get Version] can obtain the Production ID of NB Unit, Hardware Version, Kernel Version, Rootfs Version, GUI Version, GUI Data Version, Comserver Version and Servo Version.

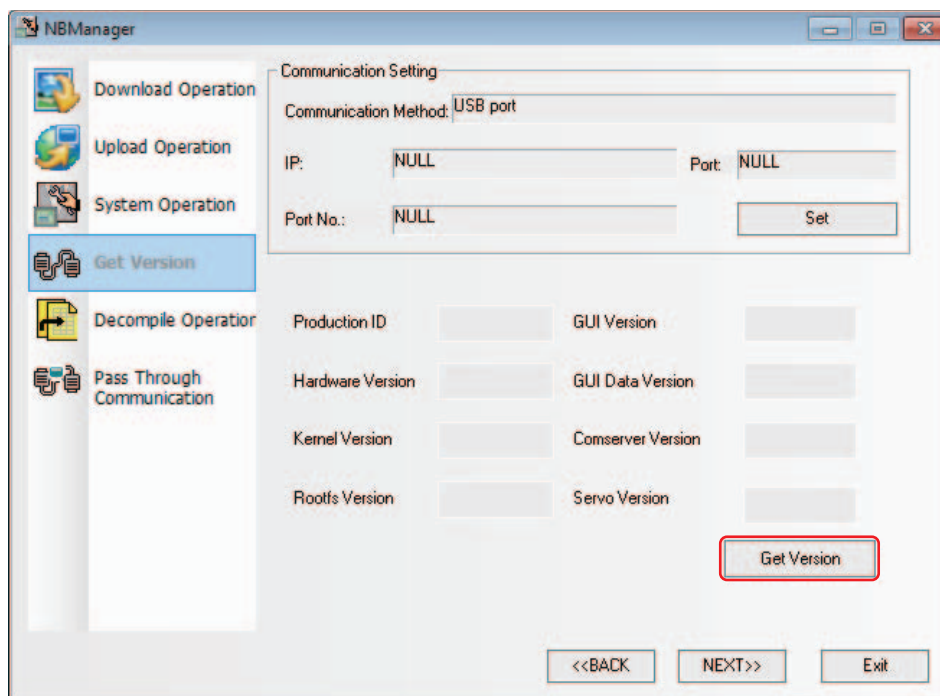

## 4-6 Decompile Operation

### ● Decompile Operation:

Convert PKG file to the format which can be handled with the NB-Designer.

**Note** When the multiple PTs are registered in a project, all the PKG files of PTs registered in the project are necessary to be prepared.

- 1 Select .pkg files.
- 2 Set the folder of "Select Target Project Folder to Decompile".

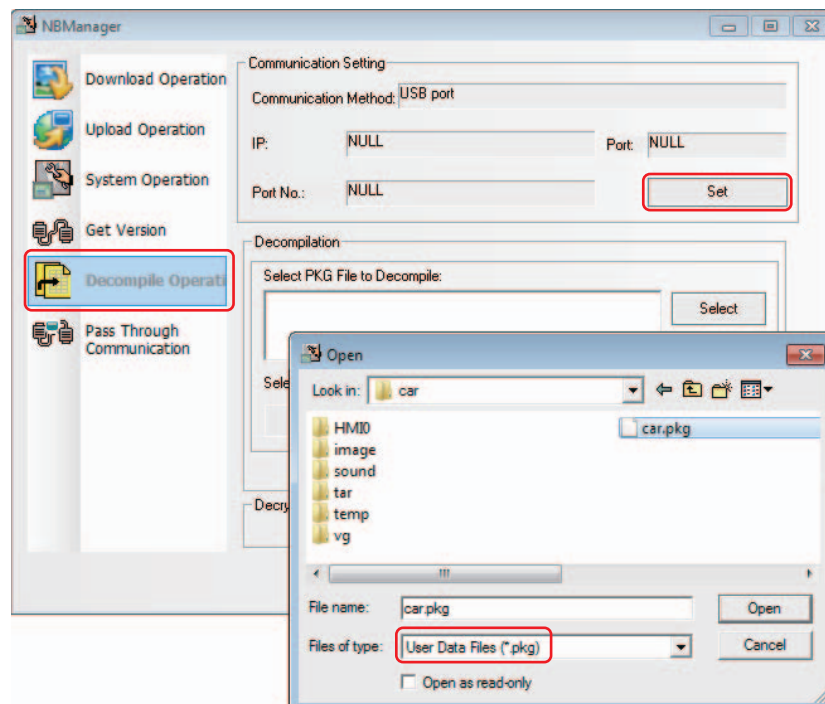

- 3 Click the [Decompile] button and input the decompile password, then click the OK button. When the decompile is completed, "Decompilation success!" dialog box will pop up.

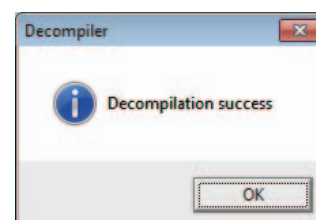
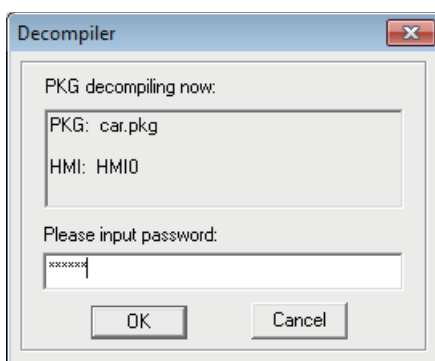

The prerequisite for the decompile operation is "Allow Decompile" is checked and the password is set in the [PT Extended Properties] tab during the project creation. The default decompilation password is 888888.

## 4-7 Web Interface Operation

Set User Name and Password for using Web Interface. Refer to *Web Interface (Page 8-1)* in *NB-Designer Operation* for the details of the Web interface. An Ethernet port is required to use this function.



### Precautions for Correct Use

When you use Web interface, always modify User Name and Password into ones other than the default settings in the respect of security.

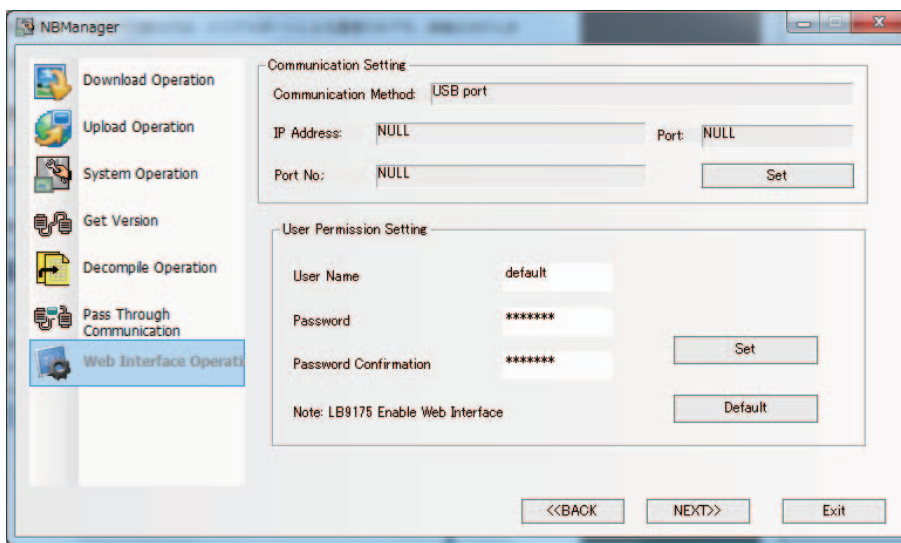

- 1** Set User Name.
- 2** Set Password and Password Confirmation.
- 3** When you click [Set], User Name and Password will be transferred to the NB Unit.

**Note 1** Available number of character available to set User Name and Password is 32 characters at max. Also the available characters are restricted to single-byte alphanumeric and upper and lowercase are distinguished.

- 2** Clicking [Default] allows the User Name and Password to be returned to the default.

# 5

## Maintenance and Abnormality Handling

This section describes the maintenance and check to prevent the abnormality occurrence and the handling of the abnormalities occurred in NB Unit.

---

<b>5-1 Maintenance</b> .....	<b>5-2</b>
<b>5-2 Checking and Cleaning</b> .....	<b>5-4</b>
<b>5-3 Abnormality Handling</b> .....	<b>5-6</b>
<b>5-4 Unit Replacement Precautions</b> .....	<b>5-10</b>

## 5-1 Maintenance

Please perform the maintenance to ensure the NB-S series always in the optimal status.

### **WARNING**

Do not attempt to take the product apart and do not touch the product inside while the power is being supplied. Otherwise it may result in electric shock.



Always ensure that the personnel in charge confirm that installation, inspection, and maintenance were properly performed for the NB unit.

“Personnel in charge” refers to individuals qualified and responsible for ensuring safety during machine design, installation, operation, maintenance, and disposal.



Ensure that installation and post-installation checks are performed by personnel in charge who possess a thorough understanding of the machinery to be installed.



Do not use the input functions of the touch switch, etc. of the NB Unit, in applications that involve human life, in applications that may result in serious injury, or for emergency stop switches.



Do not attempt to disassemble, repair, or modify the NB Unit. Otherwise it may impair the safety functions.



Never press more than two points on the touch panel of the NB Unit at a time. Otherwise, it may activate a switch somewhere between the two points.



- **Backup of application**

When the unit needs to be repaired due to the occurrence of some faults or to be replaced by the substitute, be sure to make backup of the applications and keep it in a safe location.

- **Spare part of Unit**

It is recommended to prepare the spare part of NB Unit in advance in order to repair the system when the faults occurred in NB Unit or the screen is not clear due to the backlight life expires.

## 5-2 Checking and Cleaning

Please clean and check the NB-S series periodically to ensure the NB-S series always in the optimal status.

### ● Cleaning method

If the display part is dirty, then the screen will hard to see. Please perform cleaning periodically according to the following points:

- During the daily cleaning, please use the dry soft cloth. But if use the dry soft cloth to clean forcefully when it is too dirty, the front panel may be damaged. In this case, use the wet cloth to clean it in advance.
- When the dirt cannot be cleaned by dry cleaning, please dip the cloth into the diluted neutral washing agents (concentration of 2%) completely first, and then perform cleaning after the wet cloth is wringed out.
- Waste, ethylene products or tape sticking to the Unit for a long period will generate dirt. If there is dirt sticking to the Unit, please remove it during the cleaning.



### Precautions for Safe Use

Do not use benzene, paint thinner, or other volatile solvents, and do not use chemically treated cloths.

### ● Checking method

Please perform checking once every 6 months to 1 year. But the frequent checking should be necessary when the Unit is used in the extreme environments such as the environment with high temperature, high humidity or more dust etc.

### ● Checking items

Please check the following items for the criterion. If the item doesn't conform to the criterion, please improve the surrounding environment, retighten the screw etc. to make it conform to the criterion.

Checking Items	Checking Contents	Criterion	Checking Method
Supply voltage	Voltage fluctuation at power terminal	Allowable voltage fluctuation range (DC24V, -15% to +15%)	Multimeter
Surrounding environment state	Ambient temperature (temperature inside operation panel)	0°~50°C	Thermometer
	Ambient humidity (humidity inside operation panel)	10%~90% RH(without condensation)	Hygrometer
	Dirt	Without dirt	Visual check
	Oil mist sticking	No oil penetrating into the space between the front panel and Unit box	Visual check



Checking Items	Checking Contents	Criterion	Checking Method
Installation state	Looseness of fixing metal pieces etc.	Specified torque	Phillips screwdrivers
	Connection state of connector for the cable	Inserted fully and without looseness.	Phillips screwdrivers
	Looseness of screw for external wiring	Without looseness	Phillips screwdrivers
	State of external connection cable	Without abnormality such as disconnection etc.	Visual check + multimeter
Object with expected life	Backlight brightness	With enough brightness Backlight life: approx. 50,000 hours (Typ) at room temperature (25 °C) with 40% brightness.	Visual check
	Battery	5 years (at 25 °C)	NB local time



### Precautions for Safe Use

- The back light or rubber packing of NB unit cannot be replaced.
- Deterioration over time can cause the touch points to move. If the Calibrate the touch panel periodically.
- Water resistance will be lost if the front sheet is torn or is peeling off. Do not use the Unit, if the front sheet is torn or is peeling off.
- Dispose of the Units and batteries according to local ordinances as they apply.
- Periodically check the installation conditions in applications where the PT is subject to contact with oil or water.
- The rubber packing will deteriorate, shrink, or harden depending on the operating environment. Inspect the rubber packing periodically.
- In order to replace the battery, the NB units are also necessary to be replaced. Although it is restricted to NB10W-01B, the battery replacement is available to be dealt as a repair.

## 5-3 Abnormality Handling

This section describes the handling methods for the abnormalities.

### ● During abnormality occurrence

When the abnormality occurred during the operation of PT unit, the following information will prompt.

### WARNING

Do not attempt to disassemble, repair, or modify the NB Unit. Otherwise it may impair the safety functions.



#### Precautions for Safe Use

Confirm the safety of the system before turning ON or OFF the power supply.

Information	Descriptions
PLC no response: cc-pp-d	PLC No Response: the 3 group of numbers following PLC No Response represent the PT No., PLC Station No. and Serial Port No. respectively.
PLC response error	PLC response error: PLC responses one piece of unexpected information which may caused by the read or write command. Please check if the device functions well.
Macro Code Error: xxxx (Macro No.)	Programming problems, endless loop or execution timeout exist in Macro. Please check the Marco. The number in the later position is the Macro No.
System error	It is system error which means the error occurs inside the PT.

## ● Solutions for “PLC no response” and “PLC response error”

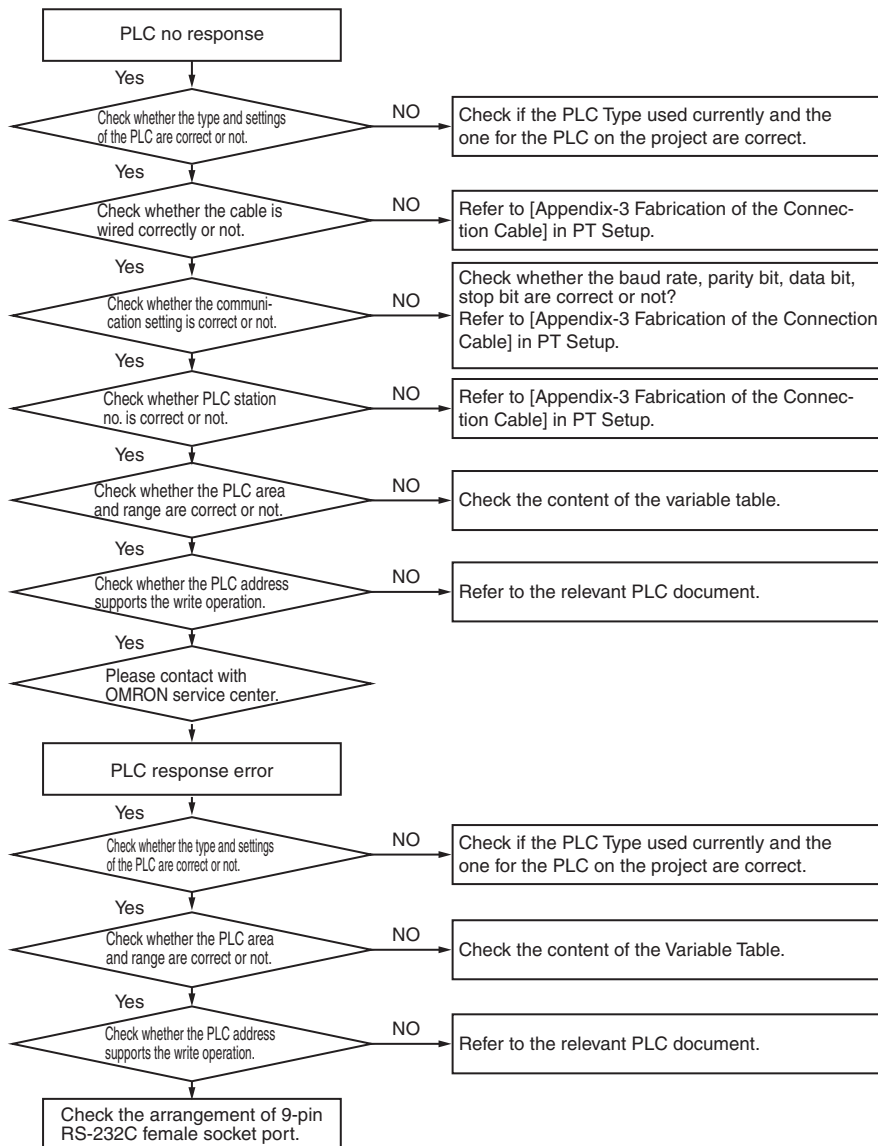

## ● When compile error occurs

In the Output Window, you can see the error number and error reason such as:

Address error for Parts or over-limit.

Using too many screens and components may cause a compile error. The number of screens should be approximately 2,000 or less, and the number of components should be 15,000 or less in the entire project.

Operations related to files cannot be executed via networks.

Do not use the system locale-dependent characters for the project file name, graphics library file name, and folder name.

- **When operations become slow or when a periodical process cannot be executed as specified**

Check the available memory space on the LW9136 system memory, and secure the adequate memory. (LW9136 shows a reference value for available memory space.)

The periodically executed processes such as alarm detection, data logging, timer, or macro may have a longer execution interval than specified or not be executed, depending on the loads caused by screen display or communication, or the overlapping processes. Check the actual operation to adjust the load of the process.

For some cases, NB-Designer will provide the information similar to “Either address is beyond the range or the value cannot be set.” as shown below during the designing period.

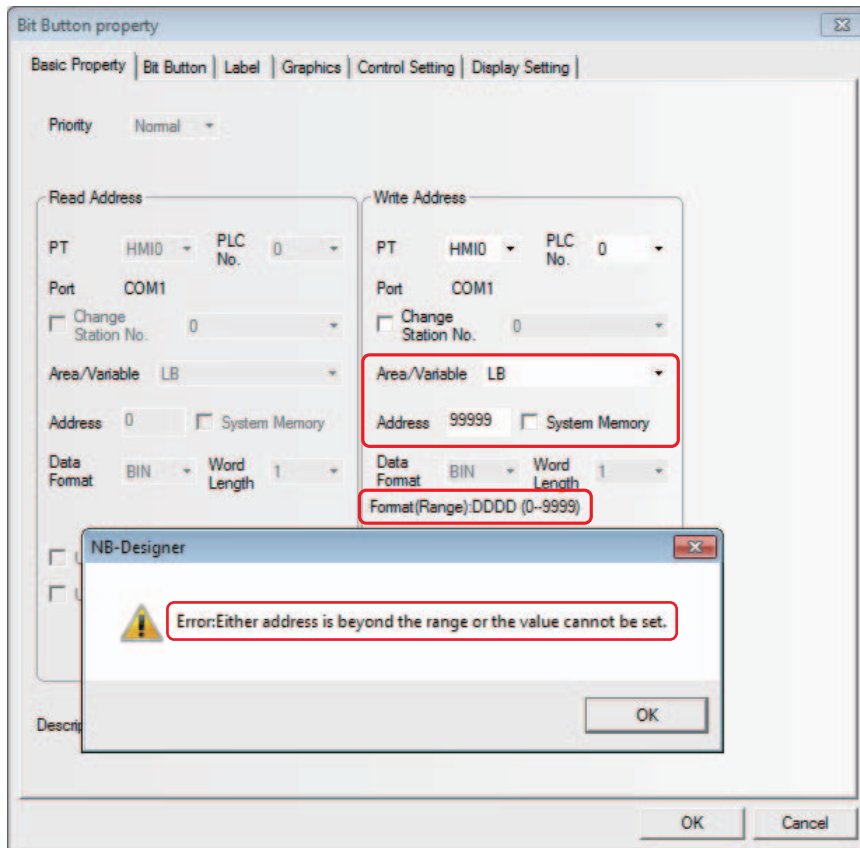

For the settings of PLC address, refer to *3-5-4 Read/Write Address for PLC (Page 3-59)* in *NB-Designer Operation* and for information of PLC address, refer to PLC manual.

Grammatical errors as C language are checked during compilation in Macro and if any problem occurs, it will be displayed.

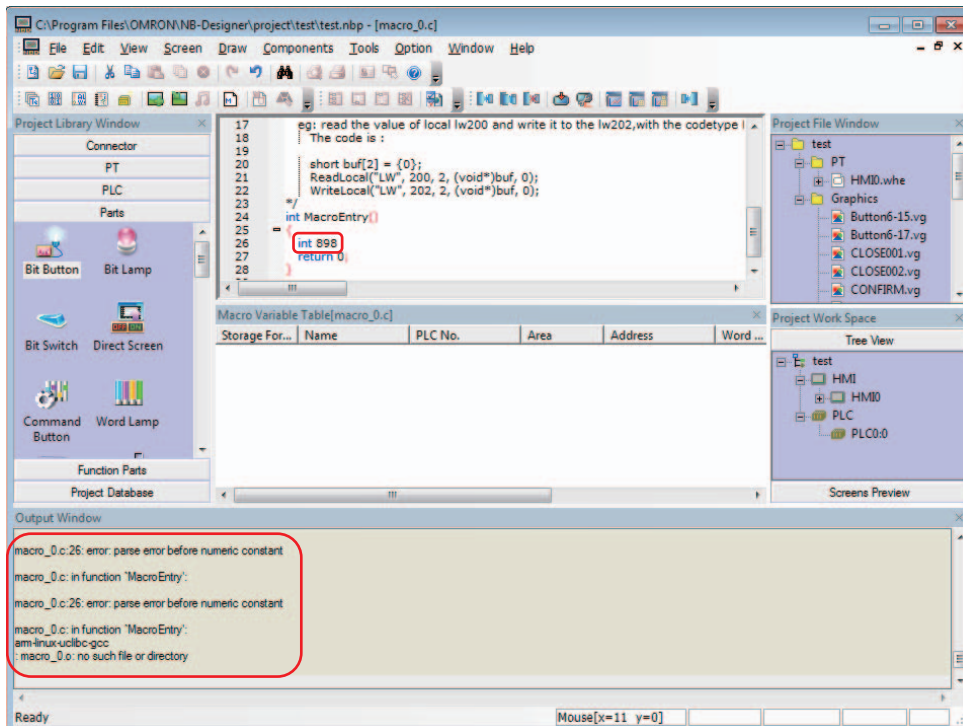

For the Macro, refer to 3-9 Macro Function (Page 3-265) in NB-Designer Operation.

- **Some parts on the screen are not updated**

Communications traffic is too much to update all the data. Reduce the number of the parts to update to the level of proper data traffic.

- **Data transmission component cannot transfer all the data**

Traffic is too high to transfer all the data. Alter the time-out setting with LW9536/9537. For the time-out setting, refer to the expression below:

$$\text{Time-out Period (T)} = \left( \frac{X}{M \times 16} + 1 \right) \times N \text{ sec.}$$

X: Total amount of transferred data (unit: word/bit)

M: The number that is defined as the maximum size of word/bit block package in the communication settings of NB-Designer.

N: The value that is set in LW9536 (write) or LW9537 (read).

## 5-4 Unit Replacement Precautions

---

When the Unit should be replaced for the defectiveness found during the checking, please pay attentions to the following points:

- Perform backup of the screen data of NB Unit in advance.
- The screen data may be deleted when the Unit is repaired by OMORN.
- Be sure to turn OFF the power supply before the replacement.
- After the replacement, please confirm whether the abnormality still exists or not.
- When the defect device is returned for repair, please attach the paper with the detailed description of the problem to the Unit, and contact the supplier printed on the back cover.

# 6

## Functions Related to External Memory

This section describes the functions related to external memory.

---

<b>6-1</b>	<b>Components Related to External Memory</b>	<b>6-2</b>
6-1-1	Function Key	6-2
6-1-2	Event, Event History Display and Event Display	6-3
6-1-3	Data History, Data Log and XY Graph	6-4
6-1-4	Operation Log	6-4
6-1-5	Recipe Data	6-5
6-1-6	CSV Import / Export	6-5
6-1-7	PLC Control	6-6
6-1-8	File List	6-7
6-1-9	FTP Server	6-7

# 6-1 Components Related to External Memory

## 6-1-1 Function Key

Save Screenshot to external memory

When the component is touched, the content of the current screen will be stored into the external memory in the form of “bmp picture”. Using the this function allows the PT screen stored as the graphics.

This function is not supported on the NB-S series.

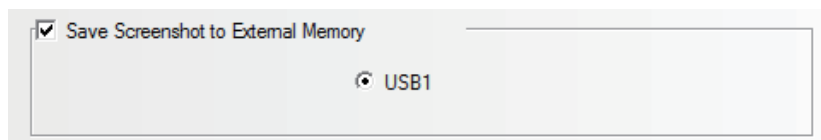
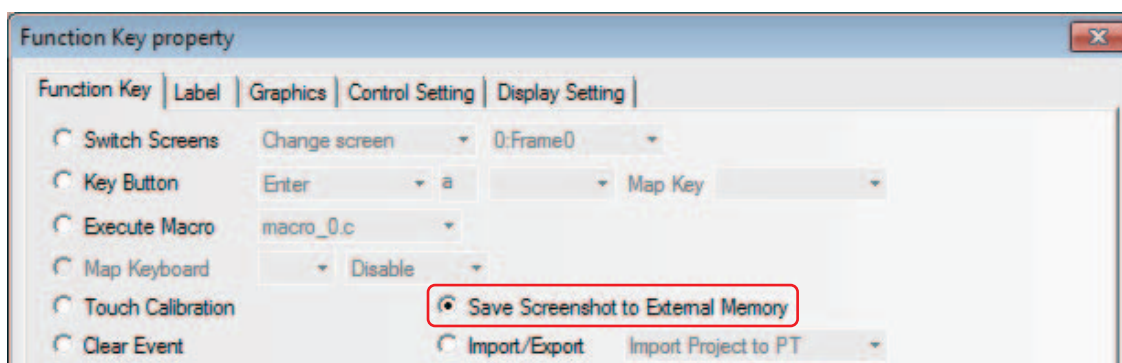

Import/Export Function

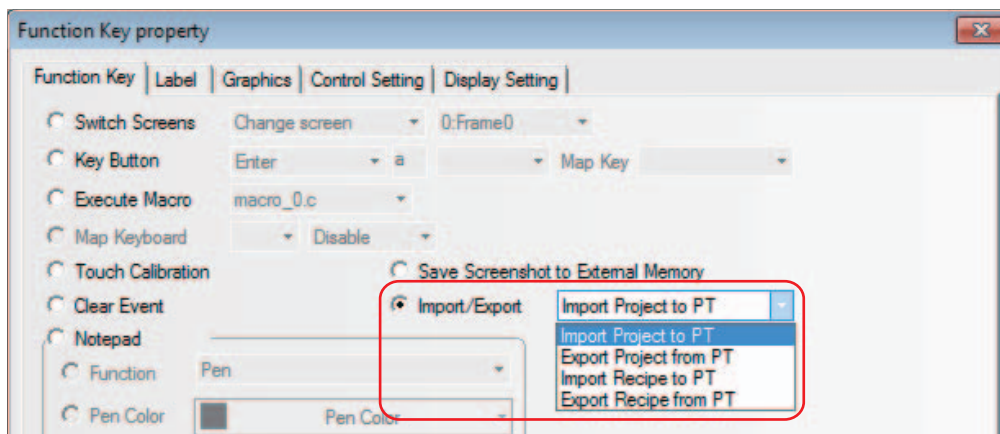

When this function is selected, touching the Function Key can realize the import or export of project data and recipe data. This function needs to be used in combination with File List component and it is only applicable to the PT with USB Host.

This function is not supported on the NB-S series.



## 6-1-2 Event, Event History Display and Event Display

### ● Saving Event, Event History Display and Event Display into the external memory:

The Event, Event History Display and Event Display can be stored in the external memory by checking the [Save to External Memory] option in the [Event History Setting] tab in the [PT Property] dialog box, as shown below:

This function is not supported on the NB-S series.

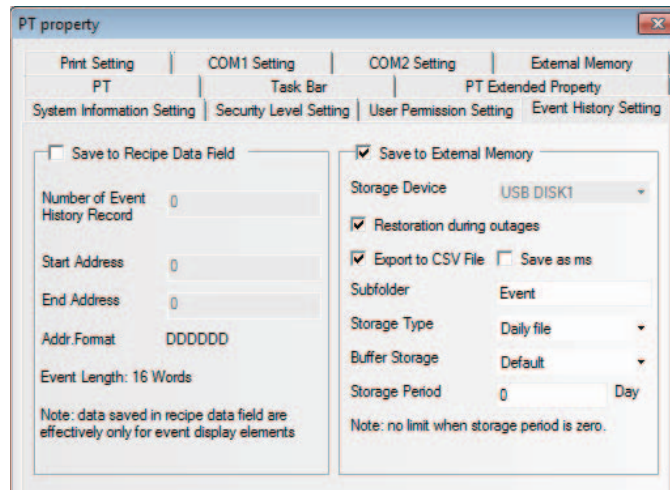

### ● Event History Display

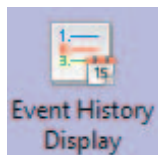

The Event History Display component is used to search and display the event history information, which is logged in “Event Setting” database and whose state meets the current triggering conditions, in the table form.

This function is not supported on the NB-S series.

### 6-1-3 Data History, Data Log and XY Graph

- **Saving the related information into the external memory:**

When the sampling data is being saved into the external memory, if you want to remove the external memory from the PT, the special system memory LB9154 (USB1) must be turned OFF before removal. If the external memory is removed without the procedure, the data will be corrupted lost.

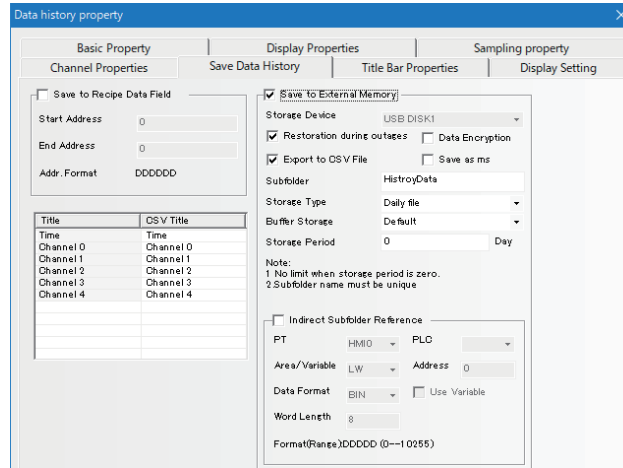

#### Descriptions of Save Historical Data

Storage Device	USB 1
----------------	-------

This function is not supported on the NB-S series.

### 6-1-4 Operation Log



Operation Log

The Operation Log component can be used to record or display the operations made by the users to the PT in the table form. The operation log will be stored into the external memory in CSV format. Settings for related Properties of Operation Log component

This function is not supported on the NB-S series.

## 6-1-5 Recipe Data

- **Saving the related information into the external memory:**

Select the external memory in the [External Memory] tab in the [PT Property] dialog box, as shown below.

This function is not supported on the NB-S series.

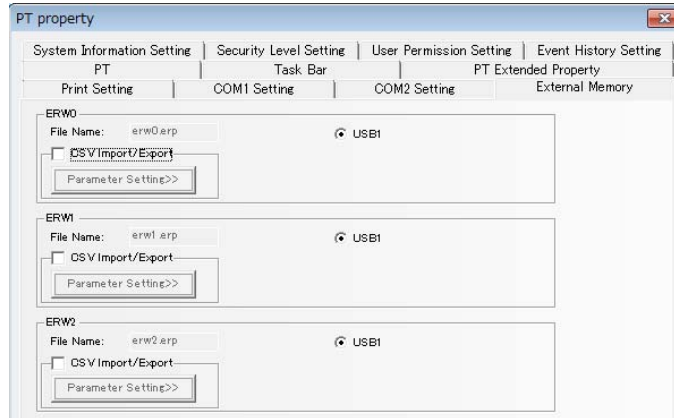

## 6-1-6 CSV Import / Export

By converting data of the CSV file stored in the external memory into ERP file, the data can be handled as ERW memory when the [CSV Import / Export] check box is checked in external memory setting.

This function is not supported on the NB-S series.

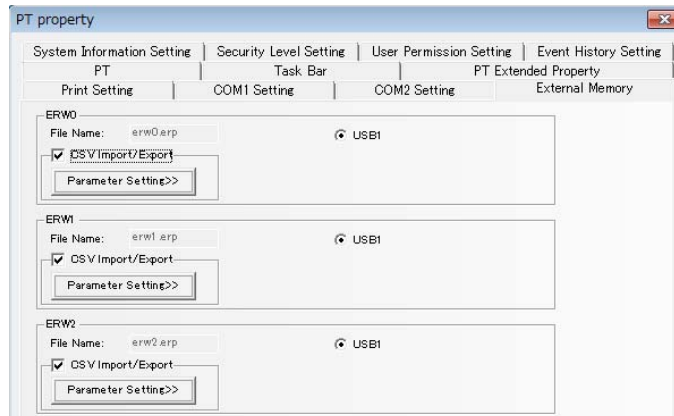

## 6-1-7 PLC Control

### Save Screenshot to External Memory

This function is not supported on the NB-S series.

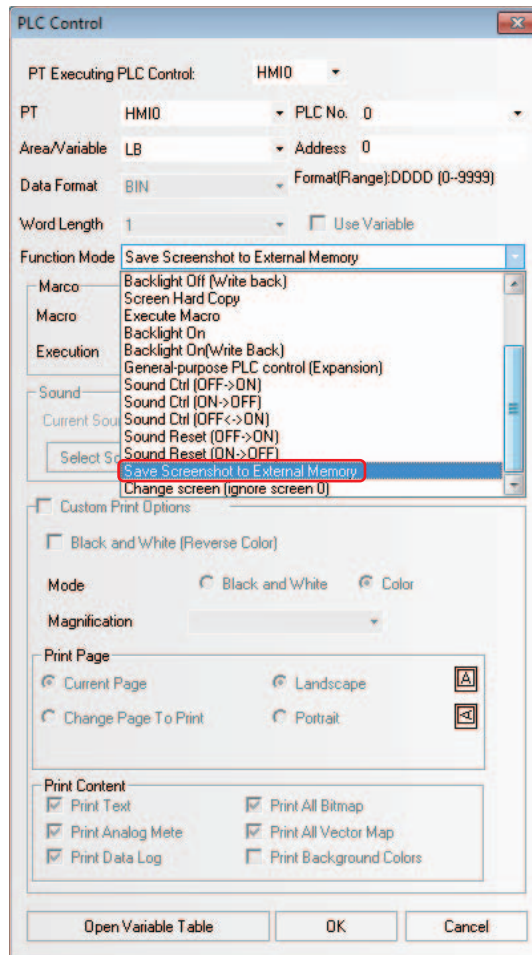

## 6-1-8 File List



The File List is used to display the file information of the external memory. This component is divided into three parts: the left part displays the information on the folder under the current folder, the upper-right part displays the information on the file under the current folder, and the lower-right part displays the PT information on the selected project file (.pkg) or the recipe file (.rcp).

This function is not supported on the NB-S series.

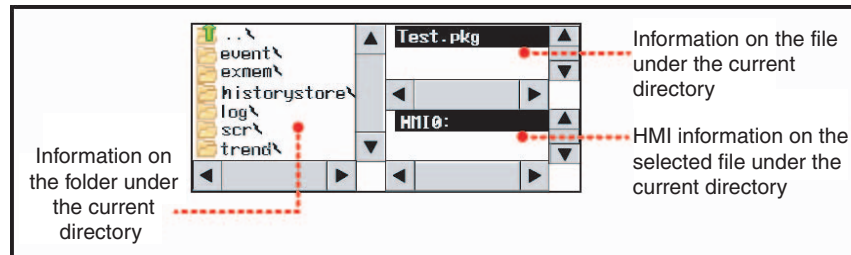

## 6-1-9 FTP Server

Upon request from the PC, FTP server transfers files in the external memory, which is inserted to the NB Unit, to the PC connected through Ethernet. This function only supports the models with Ethernet port and USB HOST.





# PictBridge Printing

This section describes the PictBridge printing function.

---

<b>7-1 PictBridge Function</b> .....	<b>7-2</b>
<b>7-2 Setting Method for Using Printing Function</b> .....	<b>7-4</b>
<b>7-3 Components Related to Printing and Setup Descriptions</b> .....	<b>7-6</b>
7-3-1 PLC Control .....	7-6
<b>7-4 List of System memories Related to Printing</b> .....	<b>7-8</b>
<b>7-5 List of Error Codes for Printing</b> .....	<b>7-9</b>
<b>7-6 Recommended Printer Models</b> .....	<b>7-10</b>

## 7-1 PictBridge Function

PictBridge is the industry standard for direct printing with the device and a printer directly connected. This standard enables digital images from the device to be printed directly by a printer, eliminating the need of connecting the device to a PC, thus greatly facilitating the printing process in various conditions.

The NB-S series touch panel supports the PictBridge protocol, and connected to such a printer with the USB Slave port, it can perform printing of images and other data.



In order to use the PictBridge function, it is necessary to update the Kernel and Rootfs in NB-Designer Ver. 1.2.2 or later. For the update method, refer to 4-4 System Operation (Page 4-15) in NB-Designer Operation.

When downloading project from NB-Designer or transferring project from the USB to the NB Unit, if the message of "Please update the Kernel and Rootfs in the NBManager." is displayed, it means user should update the NB Kernel and root file system.

### Version information list

NB-Designer	Kernel	Rootfs	Is necessary to update?	Enable Print
Ver. 1.10	1317	1337	Necessary	-
Ver. 1.20	1317	1389		-
Ver. 1.21	1317	1389		Checked by default
Ver. 1.22	1458	1517	Unnecessary	Checked by default
Ver. 1.23 or later	1458	1548	Determined by the user project *	Unchecked by default

\* If the printing function is not required, the user should uncheck the "Enable Printing" before opening the previous project with the NB-Designer version 1.23. Then recompile and download the project.



● The printing function updates flow chart

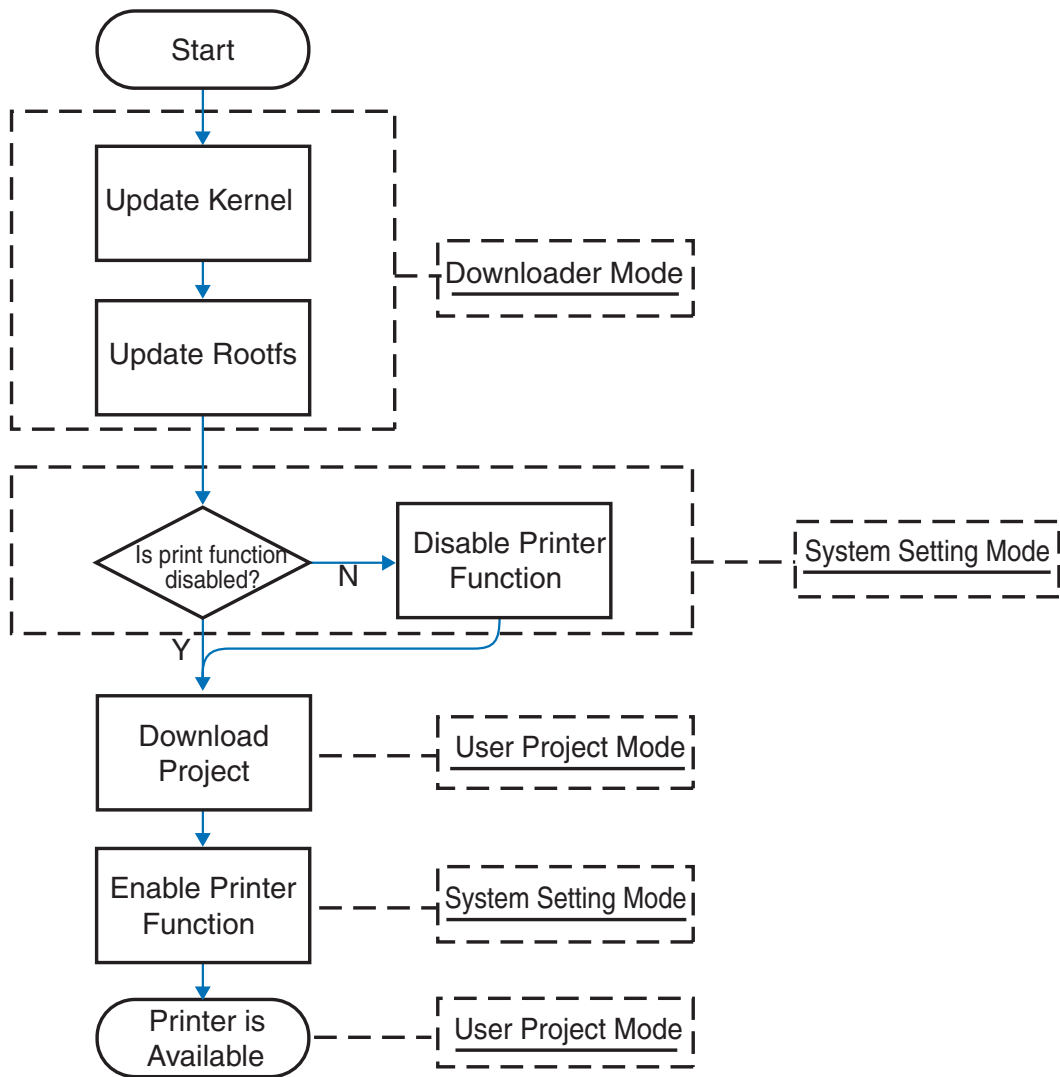

## 7-2 Setting Method for Using Printing Function

- 1 After the project being completed, compile it with the [Enable Print] option in the [Print Setting] tab in the [PT Property] dialog box being checked.

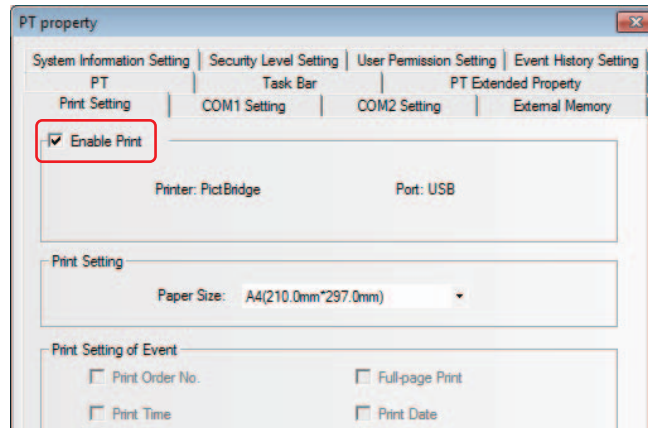

- 2 Change NB Unit to the System Setting Mode. Refer to 3-1 Display Method of System Setting Mode (Page 3-2) in PT Setup. Then download project to the NB Unit after the compilation is completed.

- 3 Check the “Enable Printer Function” option to enable the printing operation.

The locations of “Enable Printer Function” in the System Setting Mode for different PTs:

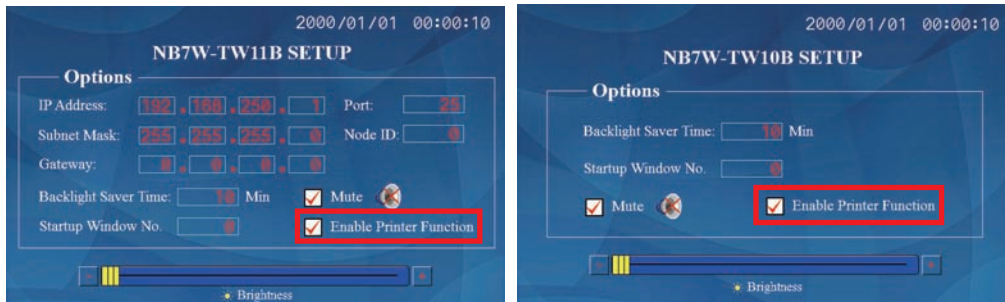

- 4 Power off and on the NB. Then Change NB Unit to the User Project Mode.

- 5 Use the USB cable to connect the USB Slave port on the back side of NB Unit with the printer for printing.

- Note**
- 1 The USB slave port on NB Unit is used for the upload/download and commissioning of program by default, but in the User Project Mode, it will shift to a USB port only supporting the printing function instead of other functions when the “Enable Print” option in the System Setting Mode is checked.
  - 2 In the Downloader Mode or System Setting Mode, the function of using USB Slave port to download always works properly without the influence of the above settings.
  - 3 If the printer cannot work normally as a result of the NB Unit power-on or other operations, please restart the printer.
  - 4 When the printing function cannot be used, refer to 6-3-1 Software Trouble in the NB Series Startup Guide Manual for the solution.

● The descriptions of USB Slave port in the User Project Mode:

Setting Items		[Enable Print] (set in the NB-Designer)	
		Checked	Unchecked
[Enable Printer Function] (set in the System Setting Mode)	Checked	USB slave port is only for printing.	Since the project is not set in printing mode, printing is not available.
	Unchecked	USB slave port can't be used for printing because it is in download mode.	Since settings of the NB unit and the project are not set in printing mode, printing is not available.

In conclusion, the printing is available only after the printing function in NB-Designer and NB Unit are both enabled.

# 7-3 Components Related to Printing and Setup Descriptions

## ● Related Components List

Component name	Function	Trigger address	Print contents
PLC Control	Screen Hard Copy	Bit	Prints the current screen

### 7-3-1 PLC Control

#### ● Screen Hard Copy

Screen Hard Copy is to control the printout of the current screen allocated to the bit address of PLC control. When the address of the specified memory is turned from OFF to ON, the current screen contents will be printed out.

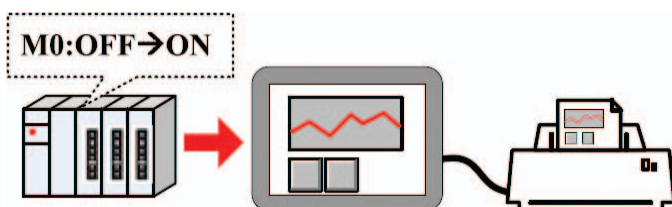

The print content output mode setting:

Method 1: Check [Custom Print Options].

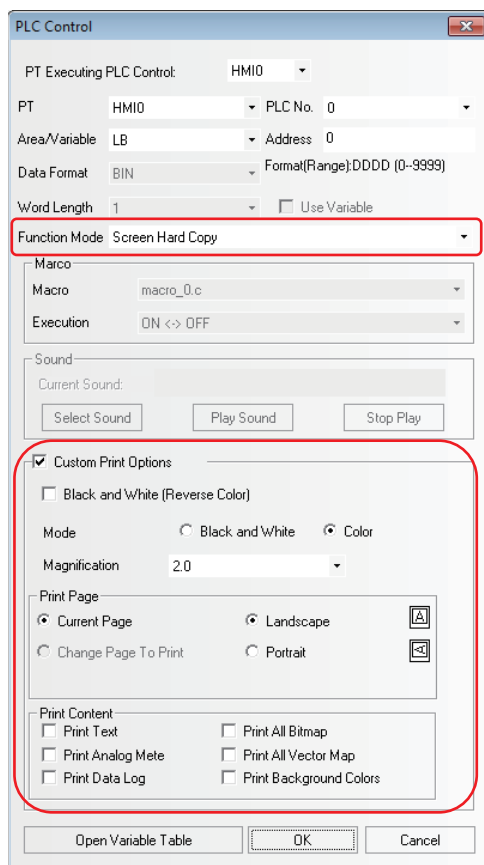

**Custom Print Options Properties Description:**

Custom Print Options Properties		Details
Printer Color	Black and White	Only color printers support printer color change.
	Color	
	Black and White (Reverse Color)	Prints the monochrome in reverse color.
Magnification	It can be selected from 0.1 to 5.0 (Zoom Out printing may cause distortion, thus is not recommended.)*	
Print Page	Current Page	Print the current screen.
	Landscape	print the content with landscape orientation.
	Portrait	print the content with portrait orientation.
Print Content	Print Text	Prints the static texts and label characters on the current screen.
	Print Analog Meter	Prints the Analog Meter components on the current screen.
	Print Trend Graph	Prints the Trend Graph on the current screen.
	Print All Bitmap	Prints all the Bitmaps on the current screen.
	Print All The Vector Map	Prints all the Vector Graphics on the current screen.
	Print Background Colors	Prints the background color of the current screen.

\* Default Magnification (based on standard A4 paper):

		PT Model			
		NB3Q/NB5Q -TW□□B		NB7W/NB10W-TW□□B	
Print Direction		Landscape	Portrait	Landscape	Portrait
Display Mode	Horizontal Display	4	3	2	1.4
	Vertical Display	3	4	1.4	2

Method 2: Don't check Custom Print Options, and make the setting through the corresponding bits of the system memories LW9054 and LW9055.

Lw9054 Settings			
Bit No.	Name	0 (The bit is OFF)	1 (The bit is ON)
Bit 0	Print Text	Not print	Print
Bit 1	Print Analog Meter	Not print	Print
Bit 2	Print Trend Graph	Not print	Print
Bit 3	Print All Bitmap	Not print	Print
Bit 4	Print All The Vector Map	Not print	Print
Bit 5	Print Background Colors	Not print	Print

The value of LW9054 can be set with the Command Button component. If all contents on the PT screen are to be printed, place the Command Button component to the Common Sheet. Select [Set value when screen is loading] in the [Command Button] tab of the [Command Button Property], specify [Set Value] to "255", and specify LW9054 to a value allow all the content printed.

Lw9055 Settings			
Bit No.	Name	0 (The bit is OFF)	1 (The bit is ON)
Bit 0~ Bit 7	Magnification	Ranges from 1 to 50 with the meaning of magnifying 0.1 to 5.0 times respectively.	
Bit 8	Printer Color	Color	Black and White
Bit 9	Print Page	Prints the current page	System Reserved
Bit 10	Print Direction	Landscape	Portrait
Bit 12	Reverse Color Print	Normal Print	Reverse Color Print

[Example] To print the content in the current page with a magnification of 0.3 in monochrome, set LW.B9055.0, LW.B9055.1 and LW.B9055.8 all ON, and LW.B9055.9 OFF; or set LW9055 to "259".

## 7-4 List of System memories Related to Printing

### Local Bit (LB):

Address	Function description	Property
LB9016	Printer error indication. ON: Error; OFF: Normal	Read only
LB9017	Printer control mask bit ON: Disable; OFF: Enable (default). All the print modes will be invalid when this bit is ON.	Read /Write
LB9132	Printer state. ON: Busy; OFF: Idle.	Read only
LB9133	Pretreat for improve print effect. ON: Pretreat; OFF: Direct Printing.	Read /Write
LB9143	USB printer connection status. ON: Connect; OFF: Disconnect.	Read only

### Local Word (LW):

Address	Function description	Property
LW9054	Printout format Bit0: Text 0: not print; 1: print Bit1: Analog Meter 0: not print; 1: print Bit2: trend graph 0: not print; 1: print Bit3: all bitmaps 0: not print; 1: print Bit4: all vector Map 0: not print; 1: print Bit5: Background Color 0: not print; 1: print	Read/Write
LW9055	Printout format Bit0~Bit7: 1~50 show magnification 0.1~5.0 Bit8: Printer Color 0: Color; 1: Black and White Bit9: Print Page 0: current page; 1: System Reserved Bit10: Printer Directing 0: Landscape; 1: Portrait Bit12: Reverse Color Enable 0: Normal; 1:Reverse	Read/Write
LW9800&LW9801	Current Error Codes	Read/Write

## 7-5 List of Error Codes for Printing

When the printing has some problems, error will occur in the system with the error codes displayed.



The error codes displayed include the following codes. The error codes will be displayed the PT screen and stored in the system memory (lower words) and LW9801 (higher words).

Codes (Value)	Description
0x73000000	Normal status (default).
0x7300FFF9	Printer not ready
0x7300FFFA	Printer busy (Trigger another print job when printer is printing)
0x7300FFFB	Driver & UI Printer Settings Disable
0x7300FFFC	UI Printer Setting Disable
0x7300FFFD	USB Cable not Connect
0x7300FFFE	Others Reason
0x7300FFFF	Driver is not configured
0x73010000	Paper related error (default).
0x73010100	Paper is empty.
0x73010200	Load Error - paper not loaded correctly.
0x73010300	Eject Error - paper not ejected correctly.
0x73010400	Media Error - paper not detected, paper skewed, roll paper cannot be cut or torn-off.
0x73010500	Paper jam.
0x73010600	Paper nearly empty.
0x73010700	The combination of paper type and paper size is not supported, or paper set in Printer does not match request.
0x73020000	Ink related reason (default).
0x73020100	Ink empty.
0x73020200	Ink low.
0x73020300	Waste ink error (waste-ink reservoir full).
0x73030000	Hardware-related error. (default)
0x73030100	Fatal error.
0x73030200	Service call.
0x73030300	Printer unavailable (performing maintenance or processing jobs).
0x73030400	Printer buffer memory full.
0x73030500	Lever error (lever position not correct).
0x73030600	Cover open.
0x73030700	No print unit (e.g., missing print head).
0x73030800	Ink Cover open.
0x73030900	No ink Cartridge.
0x73040000	File-related error. (default)
0x73040100	Printinfo error (the size of information set to <Printinfo> is too large.)
0x73040200	File decode error (picture format of specified image cannot be decoded).

## 7-6 Recommended Printer Models

---

Brand	Model
CANON	PIXMA IP4980
EPSON	Colorio PX-G5300
HP	HP 8500A, HP 8500A Plus





# Web Interface

---

This section describes Web Interface.

---

<b>8-1</b>	<b>Defining Web Interface</b>	<b>8-2</b>
<b>8-2</b>	<b>Setup Web Interface on a PC</b>	<b>8-3</b>
<b>8-3</b>	<b>Connection Method and Each Page Function</b>	<b>8-4</b>
<b>8-4</b>	<b>URL List</b>	<b>8-8</b>

# 8-1 Defining Web Interface

---

NB-S series Programmable Terminal provides Web Interface function which is accessible externally with the use of a Web browser. Using Web Interface function allows monitoring and operating the NB Unit screens from external device.



## Precautions for Correct Use

---

Security of this function is subjected only to Password. Give due consideration to Network configurations and exclude illegal access to accomplish the security.

In the Monitor mode, a password is not set initially. Set a password before you use the function, if necessary.

---

- Targeted Model  
NB□□-TW□1B
- Targeted Version  
NB-Designer: V1.30 or later  
Kernel: 1764 or later  
Rootfs: 1932 or later
- Operation confirmed Web browser  
Internet Explorer 8 (Windows)  
Internet Explorer 9 (Windows)  
Google Chrome 32.0.1700.107 m (Windows) \*1  
Firefox 27.0 (Windows)  
Safari (iOS6)

\*1 Uncheck the check box of Use JavaScript in Server Setting.



## Additional Information

---

Select the compatibility display when browsing it with Internet Explorer 10 or later.

---

## 8-2 Setup Web Interface on a PC

---

Perform following settings beforehand in order to use Web Interface function.

- **Setting User Name and Password for Web Interface function**

Set the User Name and Password for using this function. For the details, refer to the *4-7 Web Interface Operation (Page 4-18)* in *NB-Designer Operation*.

- **Enable Web Interface function**

In order to enable the Web Interface function, embed the function which turns LB9175 ON to the project. Additionally, the LB9175 setting is applied immediately. Restart is not necessary.



### **Additional Information**

---

NB Web interface function establishes communication by conforming to HTTP 1.0. The session-retaining function with the Keep alive function is not supported. A session begins per command. Thus, the number of units that are connected concurrently is not limited. However, when more than one PC are connected, a PC needs to wait until other PC processing is done. Thus, response may become slow.

---

## 8-3 Connection Method and Each Page Function

In order to access the NB Unit with the use of the Web browser, access [http://\[the NB Unit IP address\]/](http://[the NB Unit IP address]/). Initial display of screen may be changed according to setting. However, Menu page is displayed in factory setting.

- Menu page  
It is a page displayed by default at the time of shipment. Through this page, it is accessible to each page.

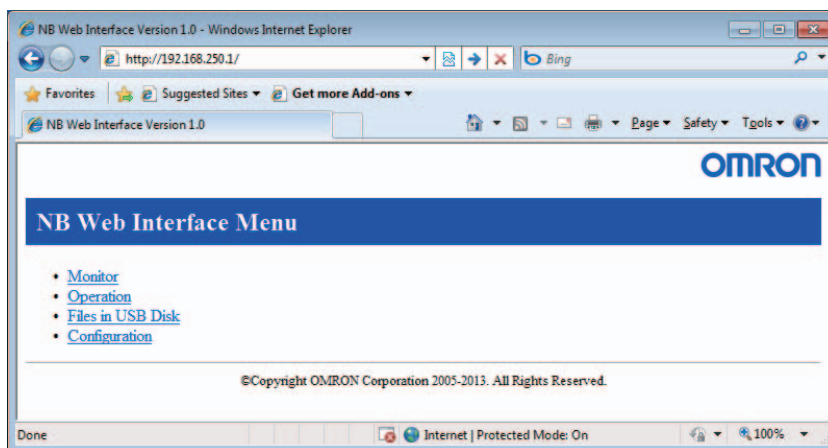

Function Name	Details
Monitor	It displays a monitoring page.
Operation	It displays an operation page.
Files in USB Disk*1	It displays a file list in the USB Disk that mounts to the NB Unit. Displaying the file contents and downloading the file are available on Web browser. This function is not supported on the NB-S series.
Configuration	It displays a configuration page.

\*1: Kernel 1764 or RootFS 2102 or higher is required.

- Monitoring page

It is a page to refer to the screen which is currently displayed on the NB Unit. A screen is updated at the interval according to the setting. The screen displayed is not available to be operated with the monitoring page.



- Operation page

It is a page to operate the screen which is currently displayed on the NB Unit.

A screen is updated at the interval according to the settings. The screen displayed is available to operate with the operation page.

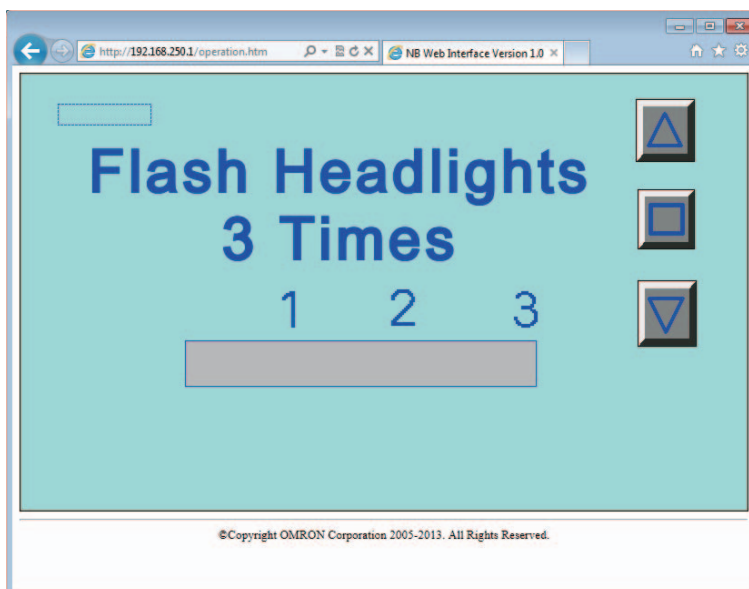

- Files in USB Disk page

- (1) File in the USB Disk page

This function is not supported on the NB-S series.

- Configuration page

It is a page to perform setting regarding Web Interface.

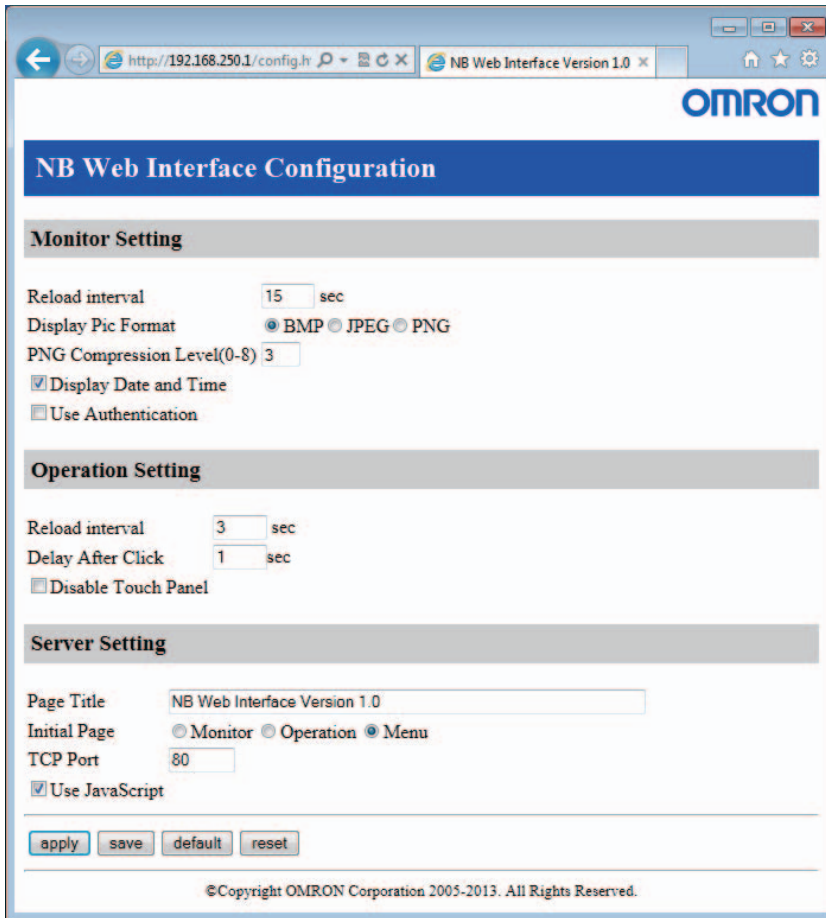

- Monitor Settings

Settings	Details
Reload Interval	Set refresh interval of Monitoring page display in the range between 2 and 99 sec.
Display Pic Format	Set format of a picture.
PNG Compression Level	Specify compression rate in the range between 0 and 8 when the picture format is designated to PNG. As the number is greater, the compression rate becomes higher.
Display Date and Time	When you need to display the date and time on the Monitoring page for what you have obtained a screen, put a check in the checkbox of this setting.
Use Authentication	When you directly specify URL for monitoring page followed by perform user authentication, put a check in the checkbox of this setting.

- Operation Settings

Settings	Details
Reload Interval	Set refresh interval of Operation page display in the range between 2 and 99 sec.
Delay After Click	Set waiting time to request next picture after clicking the screen on Web browser.
Disable Touch Panel	Put a check in the checkbox of this setting when you need to prohibit the operation of the NB Unit on Web browser.

- Server Settings

Settings	Details
Page Title	Set page title less than 64 characters. It supports only single-byte alphanumeric characters.
Initial Page	Set the page displayed by default.
TCP Port	Set Port No. of TCP.
Use JavaScript	Put a check in the checkbox when you use JavaScript for refresh processing of screen.

Functions	Details
Apply	The setting is applied by choosing this function. The setting data which is applied with apply will be restored to the state before pressing apply when the NB Unit is restarted.
Save	The setting is stored to and is applied to the NB Unit. The setting data which is applied with save will be retained even though the NB Unit is restarted.
Default	All the setting data will be restored to the state of factory setting.
Reset	All the setting data will be restored to the state before applying changes.



### Additional Information

- The following characteristics are provided for the graphic formats which are selectable by Display Pic Format.  
As the size of the graphics become larger, it takes longer to transfer the graphics. Then it takes longer to refresh the screen. In accordance with the situations, select the optimal format.

	Quality	Size
BMP	Fine	Large
JPEG	Bad	Small
PNG	Fine	Rather Large

- If Reload interval is too short, the transferring may be too late for displaying the graphic correctly.  
Set the value in which should be considered the status of transferring pathway and others.

## 8-4 URL List

---

Accessing the following URL when you use Web Interface allows you to access directly each page.

Page name	URL
Menu page	http://[the NB Unit IP address]/menu.html
Monitoring page	http://[the NB Unit IP address]/monitor.html
Operation page	http://[the NB Unit IP address]/operation.html
Files in USB Disk page	http://[the NB Unit IP address]/usbdisk.html
Configuration page	http://[the NB Unit IP address]/config.html



# App

## Appendices

---

---

<b>A-1 List of Models .....</b>	<b>A-2</b>
<b>A-2 NB-Designer Function List .....</b>	<b>A-5</b>
<b>A-3 List of memories supported by OMRON PLC .....</b>	<b>A-10</b>
<b>A-4 Usage of Forced Address Bit .....</b>	<b>A-15</b>
<b>A-5 Differences of the software between NB and NB-S .....</b>	<b>A-16</b>

# A-1 List of Models

---

- NB Unit

Models	Resolution	Size	Communication	USB (Equivalent of USB 2.0 Full Speed)
NB7W-TW10B	WVGA 800×480	7 inches	COM1	Slave
NB7W-TW11B	WVGA 800×480	7 inches	Ethernet	Slave

● **Units at the host side which can be connected using the serial port of the NB Unit in the RS-232C mode through Host Link**

PLC Series	CPU Unit with built-in Host Link function	Through Serial Communication units/boards	Options required for connection
CP Series		CP1L-L14/L20/M30/M40/M60	CP1W-CIF01
		CP1H-X40/XA40/Y20	CP1W-CIF01
	CP1E-N14/N20		
	CP1E-N30/N40/N60/NA20	CP1E-N30/N40/N60/NA20	CP1W-CIF01
		CP1L-EL20/EM30/EM40	CP1W-CIF01
	CP2E-E14/E20/E30/E40/E60 CP2E-S30/S40/S60	CP2E-N14/N20/N30/N40/N60	CP1W-CIF01 CP2W-CIFD1/CIFD2 (*2)
C Series	C200HE-CPU42 C200HE-CPU42-Z	C200HE-CPU32/42 C200HE-CPU32/42-Z	C200HW-COM02/04/05/06-V1
	C200HG-CPU43/63 C200HG-CPU43/63-Z	C200HG-CPU33/43/53/63 C200HG-CPU33/43/53/63-Z	C200HW-COM02/04/05/06-V1
	C200HX-CPU44/64 C200HX-CPU44/64/65/85-Z	C200HX-CPU34/44/54/64 C200HX-CPU34/44/54/64/65/85-Z	C200HW-COM02/04/05/06-V1
	CPM2C-10/20□□□□□□□□ (*1)		
CS Series	CS1G-CPU42/43/44/45 (-V1) CS1H-CPU63/64/65/66/67 (-V1)	CS1G-CPU42/43/44/45 (-V1) CS1H-CPU63/64/65/66/67 (-V1)	CS1W-SCU21 (-V1) CS1W-SCB21/41 (-V1)
	CS1G-CPU42H/43H/44H/45H CS1H-CPU63H/64H/65H/66H/67H	CS1G-CPU42H/43H/44H/45H CS1H-CPU63H/64H/65H/66H/67H	CS1W-SCU21 (-V1) CS1W-SCB21/41 (-V1)
CJ Series	CJ1G-CPU44/CPU45	CJ1G-CPU44/CPU45	CJ1W-SCU21/41/-V1
	CJ1G-CPU42H/43H/44H/45H CJ1H-CPU65H/66H/67H	CJ1G-CPU42H/43H/44H/45H CJ1H-CPU65H/66H/67H	CJ1W-SCU21/41/-V1
	CJ1M-CPU11/12/13/21/22/23	CJ1M-CPU11/12/13/21/22/23	CJ1W-SCU21/41/-V1
	CJ2M-CPU31/32/33/34/35		CP1W-CIF01
	CJ2M-CPU11/12/13/14/15 CJ2H-CPU64/65/66/67/68(-EIP)		
NJ Series		NJ501/301/101	CJ1W-SCU22/42
NX Series		NX1P2	NX1W-CIF01

\*1: Connect using conversion cables (CPM2C-CN111 type or CS1W-CN114/118 type), the RS-232C adaptor (CPM1-CIF01 type).

\*2: CP2W-CIFD1 option board has 2 RS-232C serial ports with different protocols. Connection with NB HMI is available only through Port 1.

● **Units at the host side which can be connected using the Ethernet port of the NB Unit**

PLC Series	CPU Unit with built-in Ethernet communication function	Through Ethernet Unit/Option boards	Options required for connection
CP Series		CP1L-L14/L20/M30/M40/M60	CP1W-CIF41
		CP1H-X40/XA40/Y20	CP1W-CIF41
		CP1E-N30/N40/N60/NA20	CP1W-CIF41
	CP1L-EL20/EM30/EM40		
	CP2E-N14/N20/N30/N40/N60		
CS Series		CS1G-CPU42/43/44/45(-V1) CS1H-CPU63/64/65/66/67(-V1)	CS1W-ETN21 CS1W-EIP21
		CS1G-CPU42H/43H/44H/45H CS1H-CPU63H/64H/65H/66H/67H	CS1W-ETN21 CS1W-EIP21
		CS1H-CPU63/64/65/66/67 (-V1)	CS1W-ETN21 CS1W-EIP21
		CS1H-CPU63H/64H/65H/66H/67H	CS1W-ETN21 CS1W-EIP21
CJ Series		CJ1G-CPU42H/43H/44H/45H CJ1H-CPU65H/CPU66H	CJ1W-ETN21 CJ1W-EIP21
		CJ1M-CPU11/12/13/21/22/23	CJ1W-ETN21 CJ1W-EIP21
		CJ1H-CPU65H-R/66H-R/67H-R CJ1H-CPU65H/CPU66H	CJ1W-ETN21 CJ1W-EIP21
	CJ2M-CPU31/32/33/34/35		
		CJ2M-CPU11/12/13/14/15	CJ1W-ETN21 CJ1W-EIP21
	CJ2H-CPU64/65/66/67/68(-EIP)		
NJ Series	NJ501/301/101		
NX Series	NX102		
	NX1P2		

● **NB-Designer information**

Descriptions	Remarks
The software that creates screen data for NB/NB-S series PT.	OS: Windows XP (SP3 or higher) Windows Vista/Windows 7/8/8.1/10 (32/64-bit) The NB-Designer incorporates a transmission program and a standard system program specified for the NB-Series Units. For download the application programs, please access your local Omron website, If local site cannot be found, please access Omron IA global site "http://www.ia.omron.com/" at first and select the area where you are.

● **Related connecting objects**

Cable with connectors (NB Unit ↔ PLC)

Models	Cable Length	Object Unit	Communications methods	Specifications
XW2Z-200T	2m	Units with 9-pin connectors by OMRON	Host Link (RS-232C)	9-pin ↔9-pin
XW2Z-500T	5m			

# A-2 NB-Designer Function List

	Items	Descriptions of Function
Parts	Bit Button	Operations such as the touch input allow the specified bit address turned ON/OFF.
	Bit Lamp	Indicates the specified ON/OFF state of one bit address.
	Bit Switch	Operations such as touch input allow the specified bit address turned ON/OFF. Specify the Read/Write addresses separately to operate them as the lamp.
	Command Button	Function Component performs several processing such as transmission of constant value.
	Word Lamp	Function Component switches the display status according to the change with value of the communications address.
	Word Switch	Function Component performs increase and decrease of the value or transmission of the value selected from the list.
	XY Graph	Describing a continuum from the value of the communications addresses as each point of coordinates in the component area. The shape can be modified dynamically.
	Moving Component	Describing the vector graphics or the bit map from the value of the communications addresses as point of coordinates. The shape can be modified dynamically.
	Animation	Draw the component with the specified track in the PT, and this position is determined by the value of the preset path and the communication addresses.
	Number Input	Display the specified value of the communication address. Also Entering number by pop-up keyboard and pressing [ENTER] allow the communication address modified.
	Number Display	Display the value of the specified communication address.
	Text Input	Set the value of the specified communication address to text string data. The input data is saved to a consecutive memory with the "Read Address" as the first address.
	Text Display	Display the value of the specified communication address as text string.
	Level Meter	Display the value of the specified communications address in a bar chart percentage style according to the set maximum and minimum values.
	Analog Meter	Display the value of the specified communication address by means of a Analog Meter diagram.
	Indirect Screen	Display the screen of the specified screen No. in pop-up screen.
	Direct Screen	Display the specified screen in pop-up screen.
	Alarm	Display the occurred alarm information in the specified area. The content displayed by the Alarm Display component is the same as that displayed by the Alarm component.
Data Log	Obtain the values of periodically specified communications address and display them in the graphic chart. The background communication still continues to do when the current screen where the Data Log locates is closed. Even after the switching the screen in which the Data Log component located to another screen, if the screen in which Data Log component located is refreshed, the sampling data which was obtained until switching the screen can be displayed.	
Recipe	Used to transfer the data from the recipe memory of PT to PLC or PLC data to the PT Recipe memory.	
Oscillograph	The Oscillograph functions similarly to the Data Log. But the data sampling of the Oscillograph is valid only during the screen in which the Oscillograph is located is displayed, which means that each time the screen is switched, the sampling data will be deleted and a new sampling will be started.	

	Items	Descriptions of Function
Parts	Scroll Bar	Move the slider to modify the value of the specified communications address.
	Event	Used to make the event information logged in “Event Information” and meeting the current triggering conditions displayed.
	Note Book	Used to modify or display the value of the specified communications address. The input data is saved to a consecutive memory with the “Read Address” as the first address.
	Word Neon Lamp	Used to display the label contents in loopy moving way, and it supports the label contents corresponding to 256 (max.) states in the loopy-moving way.
	Bit Neon Lamp	Used to display the label contents in loopy moving way, and it supports the label contents corresponding to State 0 and State 1 in the loopy-moving way.
	Touch Trigger	This function allows the multiple components operated all at once. When the communications addresses specified to the Touch Trigger component are satisfied to the trigger conditions, the components placed in the valid area for the Touch Trigger component can be triggered to act.
	Table	Used to make the selection type of “Select by row”, “Select by column” and “Select by cell”. The user can set the “Row”, “Column”, “Select Color”, “Background Color”, “Border Color”, and write the selected Row No. and Column No. into the specified communication address.
	Data History	Read the consecutive addresses of the memory periodically with the top of the specified communications address, and display in the table format.
	Event History Display	It can be used to search or display the event history information, which is recorded in the “Event Setting” database and whose current state meets the triggering conditions, in the table form. This function cannot be used on the NB-S series.
	Operation Log	It can be used to record or display the PT operations in the table form. The operation log will be stored into the external memory in CSV format. This function cannot be used on the NB-S series.
Function Parts	Scale	Draw the scale for the shapes such as portrait, landscape, arc, and circle.
	Function Key	Used to provide functions such as “Switch Screens”, “Keyboard Function”, “Execute Macro”, “Touch Calibration”, “Clear Event” and “Notepad” etc. The function key cannot be controlled by the communication address. so the execution of specified function needs to be activated by touching this component.
	Alarm Display	When the bit address specified with [Alarm Setting] matched to the trigger condition, display the specified message. The message will be displayed in loopy-moving way at the site where the alarm display is placed. The alarm information will continue to scroll until this bit address is switched to the non-alarm state.
	Timer	When the specified duration is passed, other functions such as the Macro execution, writing the value, or the data transmission are performed.
	Bitmap	Used to call and display the bg-form graphics in the system graphics library or the graphics library in project file window. The graphics in the formats such as .jpg, .bmp, .gif, .png can be imported into the bitmap and displayed.
	Vector Graphics	Call and display the graphics in vg format in system graphics library displayed or project file window. Vector Graphics can be generated from the file in “.JPG, .BMP, .GIF, or .PNG” formats.
	Notepad	Draw the texts or graphics manually and freely in the specified area.
	Data Transmission	Transmitting the value of the specified communication address to the other communications address. Data Transmission can be triggered by the manual touching method or the state change of the specified address.
	FreePlotting	Draw the graphics with the pixel based on the consecutive data stored in the specified communications addresses.

	Items	Descriptions of Function
Function Parts	Date/Time	Used to display the value of the RTC clock inside the PT in the set format.
	Indirect Shape	Modifying the specified communications addresses allows the specifying rectangle, ellipse, location and size of the lines to draw the shape.
	User Information	Used to display the related information of the current login user in the table form.
	Multifunction	Used to incorporate the Bit Button component and Command Button component into one component, thus making the user realize the Bit Set and Word Set operations through only one key.
	Event Display	Display the event information with [Event Setting] matching to the specified trigger condition.
	File List	The File List is used to display the file information of the external memory. This component is divided into three parts: the left part displays the information on the folder under the current folder, the upper-right part displays the information on the file under the current folder, and the lower-right part displays the PT information on the selected project file. This function cannot be used on the NB-S series.
Project Database	Text Library	Specify the necessary text strings in advance, thus preventing the label with the same text from being input frequently.
	Variable Table	It is a useful address library, which prevents the inconvenience resulting from repeated input of address.
	Alarm Setting	Specifying the message displayed in [Alarm] or [Alarm Display] and the bit address and the trigger conditions applied to the trigger. If the bit address registered to [Alarm Setting] matches the specified trigger condition, the registered message will be displayed.
	Event Setting	Specifying the function operated with the message displayed in [Event] or [Event Display], the communications addressed which should be the trigger, and the trigger condition. If the bit address or word address registered to the [Event Setting] are matched the specified trigger condition, the registered function can be operated or the registered message can be displayed.
	PLC Control	Specify the communication address allocated to the specific functions as follows. It is available to select among the screen switching, writing the data (the current base screen) in the PLC, general PLC controlling, turning OFF the back light, and turning ON the back light and others.
Screen Type	Base Screen	It is the general screen.
	Common Sheet	There is only 1 Common Sheet, which can be set to above or under the Base Screen. The maximum number of Base Screen ejected in 1 Common Sheet is up to 16.
	Menu Screen	There is only 1 Menu Screen, which will appear only after "Menu" is touched.
	Sheet Screen	Up to 3 Sheet Screens can be set for 1 Base Screen.
	Pop-up Screen	The types are "Tracking", "Modal", "Clipping" and "Fixed". It can be displayed normally or in the top layer. The maximum number of Pop-up Screen ejected in 1 Base Screen is up to 16.
	Direct Screen	Up to 16 Direct Screens can be displayed simultaneously in 1 Base Screen. It is controlled by the bit.
	Indirect Screen	Up to 16 Indirect Screens can be displayed simultaneously in 1 Base Screen. It is controlled by word.
Screen Property	Security level of the screen, screen attribute, background color, transparency rate, width and color of frame, location to place screen, size of screen (width and height), sheet screen allocated to screen (three screens at max.), type of pop-up used as pop-up can be specified.	

	Items	Descriptions of Function
Screen Number	Maximum Screen Number	It is up to 32768.
	Screen No.	It includes 0 and 10 to 32767 (Base Screens) 1: Common Sheet (Default) 2: Menu Screen (Default) 3: NUM Keyboard (Default) 4: ASCII Keyboard (Default) 5: File List Screen (Reserved by system) 6: Password Screen (Reserved by system) 7: Confirmation Screen (Default) 8: HEX Keyboard (Default) 9: Login Screen (Default)
Screen Switching Method		The function of switching screen with [Function Key] allows switching the displayed screen to optional base screen, common sheet screen, menu screen, or pop-up screen.
		Entering the optional screen No. to the communications address specified to the function of switching screen with [PLC Control] allows switching the screen to the screen with the entered screen No.
Macro Function		The function to create the simple original program by the user and to execute it. The user can add the functions such a arithmetical operations or discriminant of the conditions which are not be supported by the basic functions of the NB-Designer. Using the Macro function, the user also convert the display processing in the screen or the data processing used to be performed in the PLC. This function allows the PC loading reduced. The Macro of the NB-Designer conforms to C Language (ANSI C89).
Internal Address inside PT	LB	Refers to the local bit address of PT, which can't be saved when power is OFF.
	RB	Refers to the absolute address of bit address saved in the recipe data that is stored in the flash memory, even when the power turns OFF, the data can be retained. Even if the battery is dead in PT, the data stored in the recipe memory will not be lost.
	RBI	Refers to the index address of bit address saved in the recipe data that is stored in the flash memory, even when the power turns OFF, the data can be retained. Even if the battery is dead in PT, the data stored in the recipe memory will not be lost.
	LW.B	Refers to the bit address corresponding to the local word address of PT, which can't be retained when the power is OFF.
	FRB	Refers to the bit address to be stored in the flash memory, even when the PT turns OFF, the stored data can be retained. When the battery is dead in PT, the data saved in flash memory will not be affected.
	FRBI	Refers to the index address of bit address saved in flash memory, which can be retained when the power of PT turns OFF. When the battery is dead in PT, the data saved in flash memory will not be affected.
	LW	Refers to the local word address of PT, which can't be retained when power is OFF.
	RW	Refers to the absolute address saved in the recipe data that is stored in the flash memory, which can be retained when the power of PT turns OFF. Even if the battery is dead in PT, the data stored in the recipe memory will not be lost.
	RWI	Refers to the index address saved in the recipe data that is stored in the flash memory, which can be saved when the power is OFF. Even if the battery is dead in PT, the stored data in the flash memory can be retained.
FRW	Refers to the word address stored in the flash memory, which can be retained when the power of PT turns OFF. When the battery is dead in PT, the data saved in flash memory will not be affected.	



	Items	Descriptions of Function
Internal Address inside PT	FRWI	Refers to the index address of word address saved in flash memory, which can be retained when the power of PT turns OFF. When the battery is dead in PT, the data saved in flash memory will not be affected.
	ERW	Refers to the word address stored in the external memory, which can be retained when the power of PT turns OFF. When the battery is dead in PT, the data saved in external memory will not be affected.
File Formats Supported by RecipeEditor	.rcp	It is the file format which is used by PT device.
	.frp	It is the file format of Recipe data saved and used in the flash memory of the NB.
	.csv	It can be imported/exported with Microsoft Excel or others.
Security Level		The security level is classified into 16 levels (0 to 15). The optional passwords can be specified every one password for each level with eight digits. And the greater the level number, the higher the level. 15-level is the highest and 0-level is the lowest. When the security level is 0, password cannot be specified. The number of the security level is specified to "3" by default.
User Permission		User permission can be specified for 32 users at max. Also all the 32 kinds of user permission can be specified for each user. The same user permission can be specified to the multiple different users. The addition and deletion of user or the modification of user permission settings can be performed on NB units using system memory. The default valid time of user permission is 10 minutes. When 10 minutes passed after the login, this user permission will be automatically cancelled, and the operation permission can be obtained by inputting the password again.

**Note** Data saving into a flash memory such as RB/RW and FRB/FRW or an external memory such as ERW is performed in accordance with CPU's processing load.  
 If turning off the power before saving, you may lose data because data is not instantly saved.

# A-3 List of memories supported by OMRON PLC

## ● Omron C Series

Device	Bit Address	Word Address	Format
Counter (Completion Flag)	C_FLAG 0-511	-----	DDD
Timer (Completion Flag)	T_FLAG 0-511	-----	DDD
Holding Area	H_bit 00.00-99.15	-----	DD.DD
Data Area	D_bit 0000.00-6655.15	-----	DDDD.DD
Link Area	LR_bit 00.00-63.15	-----	DD.DD
Auxiliary Area	A_bit 00.00-27.15	-----	DD.DD
CIO Area	CIO_IR_bit 000.00-511.15	-----	DDD.DD
Counter Area	-----	C 000-511	DDD
Timer Area	-----	T 000-511	DDD
Holding Area	-----	H 00-99	DD
Data Area	-----	D 0000-6655	DDDD
Link Area	-----	LR 00-63	DD
Auxiliary Area	-----	A 0-27	DD
CIO Area	-----	CIO_IR_word 000-511	DDD

## ● Omron CJ/CS/NX Series

Device	Bit Address	Word Address	Format
CIO Area	CIO_bit 0000.00-6143.15	-----	DDDD.DD
Work Area	W_bit 000.00-511.15	-----	DDD.DD
Auxiliary Area	A_bit 000.00-11535.15	-----	DDDDD.DD
Holding Area	H_bit 000.00-1535.15	-----	DDDD.DD
Timer (Completion Flag)	T_Flag 0000-4095	-----	DDDD
Counter (Completion Flag)	C_Flag 0000-4095	-----	DDDD
Data Memory	D_bit 00000.00-32767.15	-----	DDDDD.DD
Extension Data Memory Area (E0-E18)	E0_bit 0.00-32767.15 ... E18_bit 0.00-32767.15	-----	DDDDD.DD
Extension Data Memory(E0-E18)	-----	E0 0-32767 ... E18 0-32767	DDDDD
CIO Area	-----	CIO 0000-6143	DDDD
Work Area	-----	W 000-511	DDD
Auxiliary Area	-----	A 000-11535	DDDDD
Holding Area	-----	H 000-1535	DDDD
Timer Area	-----	T 0000-4095	DDDD
Counter Area	-----	C 0000-4095	DDDD
Data Memory	-----	D 00000-32767	DDDDD
Index memory Area	-----	IR 00-15	DD
Data memory Area	-----	DR 00-15	DD



**Additional Information**

As for the NX series, only NX1P2-□□□□ is supported. To use the PLC, the settings for the memory used for CJ-series Units are required. Make the settings on the Controller Unit.

● **Omron CP Series**

Device	Bit Address	Word Address	Format
Work Area	W_bit 0.00-511.15	-----	DDD.DD
Hold Area	H_bit 0.00-1535.15	-----	DDDD.DD
Data Area	D_bit 0.00-32767.15	-----	DDDDD.DD
Counter (Completion Flag)	C_Flag 0.00-4095.00	-----	DDDD.DD
Timer (Completion Flag)	T_Flag 0.00-4095.00	-----	DDDD.DD
Auxiliary	A_bit 0.00-959.15	-----	DDD.DD
CIO Area	CIO_bit 0.00-6143.15	-----	DDDD.DD
Work Area	-----	W 0-511	DDD
Hold Area	-----	H 0-1535	DDDD
Data Area	-----	D 0-32767	DDDDD
Counter Area	-----	C 0-4095	DDDD
Timer Area	-----	T 0-4095	DDDD
Auxiliary Area	-----	A 0-959	DDD
CIO Area	-----	CIO 0-6143	DDDD

● **OMRON CJ/CS/NJ/NX Series Ethernet (UDP Slave)**

Device	Bit Address	Word Address	Format
CIO Area	CIO_bit 0000.00-6143.15	-----	DDDD.DD
Work Area	W_bit 000.00-511.15	-----	DDD.DD
Auxiliary Area	A_bit 000.00-11535.15	-----	DDDDD.DD
Holding Area	H_bit 000.00-1535.15	-----	DDDD.DD
Timer (Completion Flag)	T_FLAG 0000-4095	-----	DDDD
Counter (Completion Flag)	C_FLAG 0000-4095	-----	DDDD
Data Memory	D_bit 00000.00-32767.15	-----	DDDDD.DD
Extension Data Memory Area (E0-E18)	E0_bit 0.00-32767.15 ... E18_bit 0.00-32767.15	-----	DDDDD.DD
Counter Release Forced Status Area	C_RELEASE_STATUS 0000-4095	-----	DDDD
Timer Release Forced Status Area	T_RELEASE_STATUS 0000-4095	-----	DDDD
Holding Release Forced Status Area	H_RELEASE_STATUS 0.00-511.15	-----	DDD.DD
Work Release Forced Status Area	W_RELEASE_STATUS 0.00-511.15	-----	DDD.DD
CIO Release Forced Status Area	CIO_RELEASE_STATUS 0.00-6143.15	-----	DDDD.DD

Device	Bit Address	Word Address	Format
Holding Set/Reset Forced Release Area	H_FORCED_RELEASE 0.00-511.15	-----	DDD.DD
Holding Forced Set/Reset Area	H_FORCED 0.00-511.15	-----	DDD.DD
Work Set/Reset Forced Release Area	W_FORCED_RELEASE 0.00-511.15	-----	DDD.DD
Work Forced Set/Reset Area	W_FORCED 0.00-511.15	-----	DDD.DD
CIO Set/Reset Forced Release Area	CIO_FORCED_RELEASE 0000.00-6143.15	-----	DDDD.DD
CIO Forced Set/Reset Area	CIO_FORCED 0000.00-6143.15	-----	DDDD.DD
Task Flag Area	TK_FLAG 0-127	-----	DDD
Counter Set/Reset Forced Release Area	C_FORCED_RELEASE 0000-4095	-----	DDDD
Counter Forced Set/Reset Area	C_FORCED 0000-4095	-----	DDDD
Timer Set/Reset Forced Release Area	T_FORCED_RELEASE 0000-4095	-----	DDDD
Timer Forced Set/Reset Area	T_FORCED 0000-4095	-----	DDDD
Extension Data Memory (E0-E18)	-----	E0 0-32767 ... E18 0-32767	DDDDD
EM Area	-----	EM 0-32767	DDDDD
CIO Area	-----	CIO 0000-6143	DDDD
Work Area	-----	W 000-511	DDD
Auxiliary Area	-----	A 000-11535	DDDDD
Holding Area	-----	H 000-1535	DDDD
Timer Area	-----	T 0000-4095	DDDD
Counter Area	-----	C 0000-4095	DDDD
Data Memory	-----	D 00000-32767	DDDDD
Index memory Area	-----	IR 00-15	DD
Data memory Area	-----	DR 00-15	DD
Task Flag Area	-----	TK 00-127	DDD



**Additional Information**

As for the NX series, only NX102-□□□□ and NX1P2-□□□□ are supported. To use the PLC, the settings for the memory used for CJ-series Units are required. Make the settings on the Controller Unit.

● OMRON CP Series Ethernet (UDP Slave)

Device	Bit Address	Word Address	Format
CIO Area	CIO_bit 0000.00-6143.15	-----	DDDD.DD
Work Area	W_bit 000.00-511.15	-----	DDD.DD
Auxiliary Area	A_bit 000.00-959.15	-----	DDD.DD
Holding Area	H_bit 000.00-1535.15	-----	DDDD.DD
Timer (Completion Flag)	T_FLAG 0000-4095	-----	DDDD
Counter (Completion Flag)	C_FLAG 0000-4095	-----	DDDD
Data Memory	D_bit 00000.00-32767.15	-----	DDDDD.DD
Counter Release Forced Status Area	C_RELEASE_STATUS 0000-4095	-----	DDDD
Timer Release Forced Status Area	T_RELEASE_STATUS 0000-4095	-----	DDDD
Holding Release Forced Status Area	H_RELEASE_STATUS 0.00-511.15	-----	DDD.DD
Work Release Forced Status Area	W_RELEASE_STATUS 0.00-511.15	-----	DDD.DD
CIO Release Forced Status Area	CIO_RELEASE_STATUS 0.00-6143.15	-----	DDDD.DD
Holding Set/Reset Forced Release Area	H_FORCED_RELEASE 0.00-511.15	-----	DDD.DD
Holding Forced Set/Reset Area	H_FORCED 0.00-511.15	-----	DDD.DD
Work Set/Reset Forced Release Area	W_FORCED_RELEASE 0.00-511.15	-----	DDD.DD
Work Forced Set/Reset Area	W_FORCED 0.00-511.15	-----	DDD.DD
CIO Set/Reset Forced Release Area	CIO_FORCED_RELEASE 0000.00-6143.15	-----	DDDD.DD
CIO Forced Set/Reset Area	CIO_FORCED 0000.00-6143.15	-----	DDDD.DD
Task Flag Area	TK_FLAG 0-31	-----	DD
Counter Set/Reset Forced Release Area	C_FORCED_RELEASE 0000-4095	-----	DDDD
Counter Forced Set/Reset Area	C_FORCED 0000-4095	-----	DDDD
Timer Set/Reset Forced Release Area	T_FORCED_RELEASE 0000-4095	-----	DDDD
Timer Forced Set/Reset Area	T_FORCED 0000-4095	-----	DDDD
CIO Area	-----	CIO 0000-6143	DDDD
Work Area	-----	W 000-511	DDD
Auxiliary Area	-----	A 000-959	DDD
Holding Area	-----	H 000-1535	DDDD
Timer Area	-----	T 0000-4095	DDDD
Counter Area	-----	C 0000-4095	DDDD
Data Memory	-----	D 00000-32767	DDDDD
Index memory Area	-----	IR 00-15	DD
Data memory Area	-----	DR 00-15	DD
Task Flag Area	-----	TK 00-31	DD

**Note**

Name	Operation
Forced Reset	Turns OFF (0) the bit/flag and places it in forced status.
Forced Set	Turns ON (1) the bit/flag and places it in forced status.
Forced Set/Reset OFF Release	Turns OFF (0) the bit/flag and releases the forced status.
Forced Set/Reset ON Release	Turns ON (1) the bit/flag and releases the forced status.
Forced Set/Reset Release	Releases the forced status while retaining the ON/OFF status.

## A-4 Usage of Forced Address Bit

When the OMRON PLC is connected via Ethernet, there are some special bit addresses:  
\_FORCED, \_FORCED\_RELEASE and \_RELEASE\_STATUS.

### Usage example:

W\_FORCED, W\_FORCED\_RELEASE and W\_RELEASE\_STATUS function as follows:

W\_FORCED will enforce the address bit to 0 or 1, and then retain it in the forced status.

W\_FORCED\_RELEASE will enforce the address bit to 0 or 1, but it releases the forced state.

W\_RELEASE\_STATUS will release the forced status and make no change.

### Usage example:

Place two Bit Switch components and one Bit Button component with settings as follows:

Switch No.	Component Name	Address	Switch Type
1	Bit Switch	W_FORCED 0.00	Alternate
2	Bit Switch	W_FORCED_RELEASE 0.00	Alternate
3	Bit Button	W_RELEASE_STATUS 0.00	Set

### Perform the test:

#### Operation 1:

Firstly, touch switch 1 to specify the value to “0 (forced)” and then touch switch 2 to modify the value to “1” and it causes the bit to be released of the forced state at the same time. Also when the bit is specified to “1 (forced)” with switch 1, touch switch 2 to modify the bit to “0” and it causes the bit to be released of the forced state at the same time.

#### Operation 2:

Firstly, touch switch 1 to specify the value to “0 (forced)” and then touch switch 3, but the bit will be remained as “0” and it causes the bit to be released of the forced state. Also when the bit is specified to “1 (forced)”, touch switch 3, but the bit will be remained as “1” and it causes the bit to be released of the forced state.

### Descriptions:

From the above results, it can be concluded that the difference between W\_FORCED\_RELEASE and W\_RELEASE\_STATUS is: the former sets the value of address bit to 0 or 1, and then releases its forced status, while the latter only releases the forced status of address bit without changing its value.

As W\_FORCED\_RELEASE is readable and writable, you can allocate it as readable and writable bit.

As W\_RELEASE\_STATUS is write-only, do not allocate it to reading status processing (e.g. Reading the ON/OFF status of lamps and switches).

# A-5 Differences of the software between NB and NB-S

Differences between the software of the NB series and the NB-S series are described below.

Function	NB series	NB-S series
	NB7W-TW0 □B	NB7W-TW1 □B
USB Host	USB memory is supported.	<p>The following functions related to USB memory cannot be used.</p> <ul style="list-style-type: none"> <li>• Event history,</li> <li>• Data Log,</li> <li>• XY Graph,</li> <li>• Data History,</li> <li>• File List,</li> </ul> <p style="text-align: right;">Etc.</p>
COM port	<p>COM1 and COM2 are supported. RS232C, RS422A, and RS485 are supported. You can use the Pass-Through function on models that have COM1 port and COM2 port.</p>	<p>The NB7W-TW10B only supports COM1 (RS232C).</p> <p>For this reason, functions that use two COM ports, and the functions below that use RS422A communication and functions, or an Ethernet port, cannot be used.</p> <ul style="list-style-type: none"> <li>• PLC Host Link communication (RS422A/485)</li> <li>• Path-Through function</li> <li>• PLC Ethernet UDP communication</li> <li>• Ethernet port transmission</li> </ul> <p style="text-align: right;">Etc.</p> <p>The NB7W-TW11B only supports an Ethernet port.</p> <p>For this reason, the COM port functions below cannot be used.</p> <ul style="list-style-type: none"> <li>• PLC Host Link communication</li> <li>• Serial port transmission</li> <li>• Path-Through function</li> </ul> <p style="text-align: right;">Etc.</p>
System time	The system clock is retained in memory even when the power is off.	<p>The system clock is not retained in memory. Each time the power is turned off, the clock resets to Jan 1, 2000, 0 hours, 0 minutes, 0 seconds.</p> <p>However, if communication is performed with an OMRON PLC, you can acquire the clock from the PLC and set it as the NB clock. (Refer to Operation, 3-10-1 PT)</p>
DIP switches	<p>You can use the DIP switches to change the starting operation mode to one of the following.</p> <ul style="list-style-type: none"> <li>• User Project Mode,</li> <li>• Downloader Mode,</li> <li>• Calibrate Mode,</li> <li>• System Setting Mode</li> </ul>	<p>You can long-press the upper left corner of the screen during startup to change the starting operation mode.</p> <ul style="list-style-type: none"> <li>• User Project Mode</li> <li>• Downloader Mode</li> <li>• Calibrate Mode</li> <li>• System Setting Mode</li> </ul>



# Revision History

---

A manual revision code appears as a suffix to the Catalog number on the front cover of the manual.

Cat. No. V122-E1-□

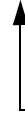

Revision code

Revision code	Date	Revised content
01	July 2016	Original production
02	October 2016	Changes and corrections
03	November 2016	Changes related to OS.
04	March 2017	Changes and corrections
05	December 2017	Changes and corrections
06	April 2018	Changes and corrections
07	October 2018	Changes and corrections
08	April 2019	Changes and corrections
09	November 2019	Changes and corrections
10	June 2020	Changes and corrections
11	October 2020	Changes and corrections
12	August 2022	Adding warnings of Safety Precautions





**OMRON Corporation Industrial Automation Company**

Kyoto, JAPAN

Contact: [www.ia.omron.com](http://www.ia.omron.com)

**Regional Headquarters**

**OMRON EUROPE B.V.**

Wegalaan 67-69, 2132 JD Hoofddorp  
The Netherlands

Tel: (31)2356-81-300/Fax: (31)2356-81-388

**OMRON ELECTRONICS LLC**

2895 Greenspoint Parkway, Suite 200  
Hoffman Estates, IL 60169 U.S.A.

Tel: (1) 847-843-7900/Fax: (1) 847-843-7787

**OMRON ASIA PACIFIC PTE. LTD.**

No. 438A Alexandra Road # 05-05/08 (Lobby 2),  
Alexandra Technopark,  
Singapore 119967

Tel: (65) 6835-3011/Fax: (65) 6835-2711

**OMRON (CHINA) CO., LTD.**

Room 2211, Bank of China Tower,  
200 Yin Cheng Zhong Road,  
PuDong New Area, Shanghai, 200120, China

Tel: (86) 21-5037-2222/Fax: (86) 21-5037-2200

**Authorized Distributor:**

© OMRON Corporation 2016-2022 All Rights Reserved.  
In the interest of product improvement,  
specifications are subject to change without notice.

Cat. No. V122-E1-12

0822