

## T20 Pendant

### User's Guide



**NOTE**

All rights reserved. No part of this publication may be reproduced, stored in a retrieval system, or transmitted, in any form, or by any means, mechanical, electronic, photocopying, recording, or otherwise, without the prior written permission of OMRON.

No patent liability is assumed with respect to the use of the information contained herein. Moreover, because OMRON is constantly striving to improve its high-quality products, the information contained in this manual is subject to change without notice. Every precaution has been taken in the preparation of this manual. Nevertheless, OMRON assumes no responsibility for errors or omissions. Neither is any liability assumed for damages resulting from the use of the information contained in this publication.

**Trademarks**

Company names and product names in this document are the trademarks or registered trademarks of their respective companies.

**Copyrights**

Microsoft product screen shots reprinted with permission from Microsoft Corporation.

# Introduction

---

This manual is OMRON's original instructions describing the setup, operation, and user maintenance of the product.

This document describes T20 Pendant functionality supported with firmware version 3.0.0.15.

Please read this manual and make sure you understand the functionality and performance of the T20 Pendant before attempting to use it.

Keep this manual in a safe place where it will be available for reference during operation.

## Intended Audience

This manual is intended for the following personnel, who must also have knowledge of factory automation (FA) systems and robotic control methods.

- Personnel in charge of introducing FA systems.
- Personnel in charge of designing FA systems.
- Personnel in charge of installing and maintaining FA systems.
- Personnel in charge of managing FA systems and facilities.

## Units

All units are metric unless otherwise noted.

# Manual Information

## Page Structure

The following page structure is used in this manual.

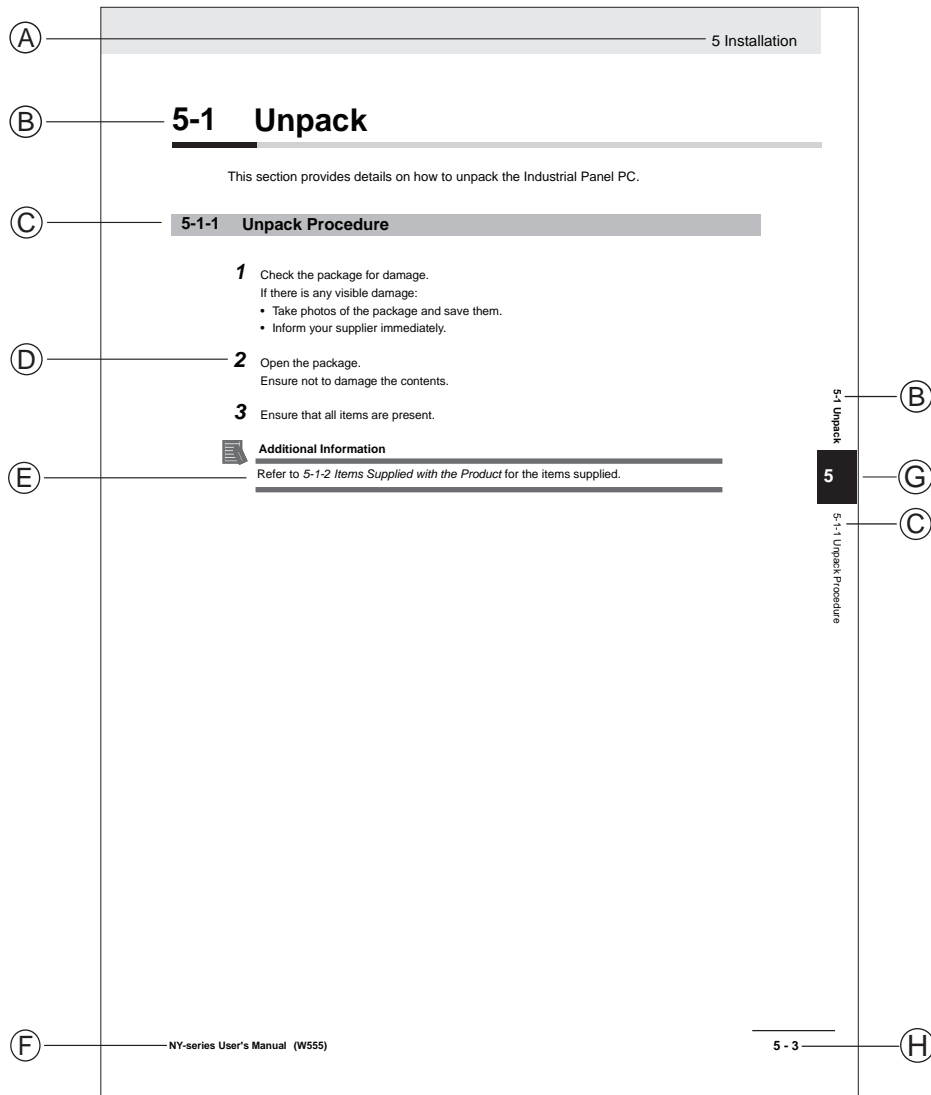

Note: This illustration is provided as a sample. It will not literally appear in this manual.

Item	Explanation	Item	Explanation
A	Level 1 heading	E	Special Information
B	Level 2 heading	F	Manual name
C	Level 3 heading	G	Page tab with the number of the main section
D	Step in a procedure	H	Page number

## Special Information

Special information in this manual is classified as follows:

**Precautions for Safe Use**

---

---

Precautions on what to do and what not to do to ensure safe usage of the product.

---

---

**Precautions for Correct Use**

---

---

Precautions on what to do and what not to do to ensure proper operation and performance.

---

---

**Additional Information**

---

---

Additional information to read as required.

This information is provided to increase understanding or make operation easier.

---

---

**Version Information**

---

---

Information on differences in specifications and functionality between different versions.

---

---



# Sections in this Manual

---



# CONTENTS

---

<b>Introduction .....</b>	<b>1</b>
Intended Audience .....	1
Units .....	1
<b>Manual Information .....</b>	<b>2</b>
Page Structure .....	2
Special Information .....	2
<b>Sections in this Manual .....</b>	<b>5</b>
<b>Terms and Conditions Agreement.....</b>	<b>8</b>
Warranty and Limitations of Liability .....	8
Application Considerations .....	8
Disclaimers .....	9
<b>Safety Precautions.....</b>	<b>10</b>
Definition of Precautionary Information.....	10
Symbols .....	10
Warnings.....	10
Cautions.....	12
<b>Precautions for Safe Use .....</b>	<b>14</b>
<b>Precautions for Correct Use .....</b>	<b>15</b>
<b>Related Manuals.....</b>	<b>16</b>
<b>Revision History.....</b>	<b>17</b>

## Section 1 Overview

---

<b>1-1 Product Description.....</b>	<b>1-2</b>
<b>1-2 Intended Use .....</b>	<b>1-3</b>
<b>1-3 Features and Components.....</b>	<b>1-4</b>
1-3-1 Pendant Indicators .....	1-4
1-3-2 Keypad Functions .....	1-5
1-3-3 Enable Switch .....	1-6
1-3-4 E-Stop Button.....	1-7
1-3-5 System Emergency Stop Circuitry .....	1-7
<b>1-4 Firmware .....</b>	<b>1-8</b>

## Section 2 Specifications

---

<b>2-1 General Specifications .....</b>	<b>2-2</b>
<b>2-2 Dimensions.....</b>	<b>2-3</b>
<b>2-3 Transport and Storage.....</b>	<b>2-4</b>



## Section 3 Operation

---

<b>3-1</b>	<b>Connecting the T20 Pendant .....</b>	<b>3-3</b>
3-1-1	Connecting the T20 Directly to the Robot .....	3-3
3-1-2	Connecting the T20 to the Robot with the SmartController EX.....	3-4
<b>3-2</b>	<b>Enabling Robot Power.....</b>	<b>3-6</b>
3-2-1	Turning High Power ON .....	3-6
3-2-2	Disabling High Power from T20 Pendant .....	3-7
<b>3-3</b>	<b>User Interface Operation .....</b>	<b>3-8</b>
3-3-1	User Interface Controls .....	3-8
3-3-2	Displaying the Home Screens.....	3-9
<b>3-4</b>	<b>Using Jog Mode .....</b>	<b>3-11</b>
3-4-1	COMP Mode .....	3-11
3-4-2	Joint Mode.....	3-11
3-4-3	World Mode .....	3-12
3-4-4	Tool Mode.....	3-13
3-4-5	Free Mode.....	3-14
<b>3-5</b>	<b>Speed Control .....</b>	<b>3-15</b>
3-5-1	Speed Indicator .....	3-15
3-5-2	Setting the Initial Speed .....	3-15
<b>3-6</b>	<b>Position Display .....</b>	<b>3-17</b>
<b>3-7</b>	<b>Smart Locations .....</b>	<b>3-18</b>
<b>3-8</b>	<b>Available Frames .....</b>	<b>3-21</b>
3-8-1	Enable Frame-Based Jogging.....	3-21
3-8-2	Frame Jogging Mode .....	3-21
<b>3-9</b>	<b>Available Tools .....</b>	<b>3-23</b>
<b>3-10</b>	<b>Location Teaching .....</b>	<b>3-24</b>
3-10-1	How to Teach a Location .....	3-25
3-10-2	How to Select an Array .....	3-25
3-10-3	Adding Approach Distance.....	3-26
3-10-4	Using JOG TO.....	3-26
3-10-5	Align .....	3-26
<b>3-11</b>	<b>I/O Signals .....</b>	<b>3-27</b>
3-11-1	Controlling the I/O Signals .....	3-27
<b>3-12</b>	<b>Displaying and Clearing Errors .....</b>	<b>3-29</b>
<b>3-13</b>	<b>System Maintenance Screen .....</b>	<b>3-30</b>
<b>3-14</b>	<b>Screen Saver Settings .....</b>	<b>3-31</b>
<b>3-15</b>	<b>Enabling Smart Locations.....</b>	<b>3-32</b>
<b>3-16</b>	<b>Setting Approach Distance .....</b>	<b>3-33</b>
<b>3-17</b>	<b>Enabling Pendant Message .....</b>	<b>3-34</b>
<b>3-18</b>	<b>System Information Screen .....</b>	<b>3-35</b>
3-18-1	Displaying System Information.....	3-35
<b>3-19</b>	<b>Displaying Recent Errors .....</b>	<b>3-36</b>
<b>3-20</b>	<b>Updating the Pendant Firmware.....</b>	<b>3-38</b>
<b>3-21</b>	<b>Loss of Communication .....</b>	<b>3-39</b>

## Section 4 Maintenance

---

<b>4-1</b>	<b>Maintenance Actions .....</b>	<b>4-2</b>
------------	----------------------------------	------------

# Terms and Conditions Agreement

## Warranty and Limitations of Liability

### Warranty

- **Exclusive Warranty**

Omron's exclusive warranty is that the Products will be free from defects in materials and workmanship for a period of twelve months from the date of sale by Omron (or such other period expressed in writing by Omron). Omron disclaims all other warranties, expressed or implied.

- **Limitations**

OMRON MAKES NO WARRANTY OR REPRESENTATION, EXPRESS OR IMPLIED, ABOUT NON-INFRINGEMENT, MERCHANTABILITY OR FITNESS FOR A PARTICULAR PURPOSE OF THE PRODUCTS. BUYER ACKNOWLEDGES THAT IT ALONE HAS DETERMINED THAT THE PRODUCTS WILL SUITABLY MEET THE REQUIREMENTS OF THEIR INTENDED USE.

Omron further disclaims all warranties and responsibility of any type for claims or expenses based on infringement by the Products or otherwise of any intellectual property right.

- **Buyer Remedy**

Omron's sole obligation hereunder shall be, at Omron's election, to (i) replace (in the form originally shipped with Buyer responsible for labor charges for removal or replacement thereof) the non-complying Product, (ii) repair the non-complying Product, or (iii) repay or credit Buyer an amount equal to the purchase price of the non-complying Product; provided that in no event shall Omron be responsible for warranty, repair, indemnity or any other claims or expenses regarding the Products unless Omron's analysis confirms that the Products were properly handled, stored, installed and maintained and not subject to contamination, abuse, misuse or inappropriate modification. Return of any Products by Buyer must be approved in writing by Omron before shipment. Omron Companies shall not be liable for the suitability or unsuitability or the results from the use of Products in combination with any electrical or electronic components, circuits, system assemblies or any other materials or substances or environments. Any advice, recommendations or information given orally or in writing, are not to be construed as an amendment or addition to the above warranty.

See <http://www.omron.com/global/> or contact your Omron representative for published information.

### Limitations of Liability

OMRON COMPANIES SHALL NOT BE LIABLE FOR SPECIAL, INDIRECT, INCIDENTAL, OR CONSEQUENTIAL DAMAGES, LOSS OF PROFITS OR PRODUCTION OR COMMERCIAL LOSS IN ANY WAY CONNECTED WITH THE PRODUCTS, WHETHER SUCH CLAIM IS BASED IN CONTRACT, WARRANTY, NEGLIGENCE OR STRICT LIABILITY. Further, in no event shall liability of Omron Companies exceed the individual price of the Product on which liability is asserted.

## Application Considerations

## Suitability for Use

---

Omron Companies shall not be responsible for conformity with any standards, codes or regulations which apply to the combination of the Product in the Buyer's application or use of the Product. At Buyer's request, Omron will provide applicable third party certification documents identifying ratings and limitations of use which apply to the Product. This information by itself is not sufficient for a complete determination of the suitability of the Product in combination with the end product, machine, system, or other application or use. Buyer shall be solely responsible for determining appropriateness of the particular Product with respect to Buyer's application, product or system. Buyer shall take application responsibility in all cases.

NEVER USE THE PRODUCT FOR AN APPLICATION INVOLVING SERIOUS RISK TO LIFE OR PROPERTY WITHOUT ENSURING THAT THE SYSTEM AS A WHOLE HAS BEEN DESIGNED TO ADDRESS THE RISKS, AND THAT THE OMRON PRODUCT(S) IS PROPERLY RATED AND INSTALLED FOR THE INTENDED USE WITHIN THE OVERALL EQUIPMENT OR SYSTEM.

## Programmable Products

---

- Omron Companies shall not be responsible for the user's programming of a programmable Product, or any consequence thereof.
- Omron Companies shall not be responsible for the operation of the user accessible operating system (e.g. Windows, Linux), or any consequence thereof.

## Disclaimers

### Performance Data

---

Data presented in Omron Company websites, catalogs and other materials is provided as a guide for the user in determining suitability and does not constitute a warranty. It may represent the result of Omron's test conditions, and the user must correlate it to actual application requirements. Actual performance is subject to the Omron's Warranty and Limitations of Liability.

### Change in Specifications

---

Product specifications and accessories may be changed at any time based on improvements and other reasons. It is our practice to change part numbers when published ratings or features are changed, or when significant construction changes are made. However, some specifications of the Product may be changed without any notice. When in doubt, special part numbers may be assigned to fix or establish key specifications for your application. Please consult with your Omron's representative at any time to confirm actual specifications of purchased Product.

### Errors and Omissions

---



Information presented by Omron Companies has been checked and is believed to be accurate; however, no responsibility is assumed for clerical, typographical or proofreading errors or omissions.

# Safety Precautions





## Definition of Precautionary Information

The following notation is used in this manual to provide precautions required to ensure safe usage of the LD-series AMR. The safety precautions that are provided are extremely important to safety. Always read and heed the information provided in all safety precautions.

The following notation is used.

 <b>DANGER</b>	Identifies an imminently hazardous situation which, if not avoided, is likely to result in serious injury, and might result in fatality or severe property damage.
 <b>WARNING</b>	Indicates a potentially hazardous situation which, if not avoided, could result in death or serious injury. Additionally, there may be severe property damage.
 <b>CAUTION</b>	Indicates a potentially hazardous situation which, if not avoided, may result in minor or moderate injury, or property damage.

## Symbols

	The circle and slash symbol indicates operations that you must not do. The specific operation is shown in the circle and explained in text. This example indicates prohibiting disassembly.
	The triangle symbol indicates precautions (including warnings). The specific operation is shown in the triangle and explained in text. This example indicates a precaution for electric shock.
	The triangle symbol indicates precautions (including warnings). The specific operation is shown in the triangle and explained in text. This example indicates a general precaution.
	The filled circle symbol indicates operations that you must do. The specific operation is shown in the circle and explained in text. This example shows a general precaution for something that you must do.
	The triangle symbol indicates precautions (including warnings). The specific operation is shown in the triangle and explained in text. This example indicates a precaution for high temperatures.

## Warnings

### General

#### ELECTROCUTION RISK

During maintenance, disconnect AC power from the robot, and install a lock-out tag-out to prevent anyone from reconnecting power.



---

**PERSONAL INJURY OR PROPERTY DAMAGE RISK**

A robot can cause serious injury or death, or damage to itself and other equipment, if the safety precautions in this manual are not observed.



---

Improper use of the pendant can cause hazards. Ensure that you always use the pendant properly, following the instructions in this manual.



---

When a joint is selected using the Joint/Axis control buttons while in Free mode, the corresponding joint is released and moves freely (in some mechanisms, multiple joints may be released). In many cases, the weight on the joint will be sufficient to move the joint and cause equipment damage or injury to personnel in the workspace.



---

When the cable entrance cover is removed, the T20 Pendant is sensitive to electrostatic discharge.



---

During maintenance, disconnect AC power from the robot, and install a lock-out tag-out to prevent anyone from reconnecting power.



---

A robot can cause serious injury or death, or damage to itself and other equipment, if the safety precautions in this manual are not observed.



## Cybersecurity

To maintain the security and reliability of the system, a robust cybersecurity defense program should be implemented, which may include some or all of the following:

### Anti-virus protection

- Install the latest commercial-quality anti-virus software on the computer connected to the control system and keep the software and virus definitions up-to-date.
- Scan USB drives or other external storage devices before connecting them to control systems and equipment.

### Security measures to prevent unauthorized network access

- Install physical controls so that only authorized personnel can access control systems and equipment.
- Reduce connections to control systems and equipment via networks to prevent access from untrusted devices.
- Install firewalls to block unused communications ports and limit communication between systems. Limit access between control systems and systems from the IT network.
- Control remote access and adopt multifactor authentication to devices with remote access to control systems and equipment.
- Set strong password policies and monitor for compliance frequently.

### Data input and output protection

- Backup data and keep the data up-to-date periodically to prepare for data loss.
- Validate backups and retention policies to cope with unintentional modification of input/output data to control systems and equipment.
- Validate the scope of data protection regularly to accommodate changes.
- Check validity of backups by scheduling test restores to ensure successful recovery from incidents.
- Safety design, such as emergency shutdown and fail-soft operations in case of data tampering and incidents.

### Additional recommendations

- When using an external network environment to connect to an unauthorized terminal such as a SCADA, HMI or to an unauthorized server may result in network security issues such as spoofing and tampering.
- You must take sufficient measures such as restricting access to the terminal, using a terminal equipped with a secure function, and locking the installation area by yourself.
- When constructing network infrastructure, communication failure may occur due to cable disconnection or the influence of unauthorized network equipment.
- Take adequate measures, such as restricting physical access to network devices, by means such as locking the installation area.
- When using devices equipped with an SD Memory Card, there is a security risk that a third party may acquire, alter, or replace the files and data in the removable media by removing or unmounting the media.
- Please take sufficient measures, such as restricting physical access to the Controller or taking appropriate management measures for removable media, by means of locking and controlling access to the installation area.
- Educate employees to help them identify phishing scams received via email on systems that will connect to the control network.



## Cautions



---

Do not use the T20 Pendant in hazardous environments (explosive gas, water, dust, oil, or mist), in mining operations, or outdoors. It has an IP rating of IP65.



---

Never clean the T20 Pendant display screen or other surfaces with solvents, abrasive cleaners, or scrubbing sponges.



# Precautions for Safe Use

---

- All personnel who install, operate, teach, program, or maintain the system must read this guide, read the Robot Safety Guide (Cat. No. I590), and complete a training course for their responsibilities in regard to the robot.
- All personnel who design the robot system must read this guide, read the Robot Safety Guide (Cat. No. I590), and must comply with all local and national safety regulations for the location in which the robot is installed.
- The robot system must not be used for purposes other than described in the robot user's guide. Contact your local OMRON representative if you are not sure of the suitability for your application.
- The user is responsible for providing safety barriers around the robot to prevent anyone from accidentally coming into contact with the robot when it is in motion.
- Lock out and tag out power to the robot and its power supply before performing any maintenance on the robot.
- You can contribute to resource conservation and protecting the environment by the proper disposal of Waste Electronics and Electrical Equipment (WEEE). All electrical and electronic products should be disposed of separately from the municipal waste system according to local ordinances using designated collection facilities.





# Precautions for Correct Use

---

To avoid malfunctions or damage through improper handling, and possible voiding of the warranty, abide by the following instructions during operation.

- When you are not using the T20 Pendant, place it in a safe location and clear of the robot working envelope.
- Never place the T20 Pendant with the display screen facing down, to avoid damaging the buttons or display.
- Never place the T20 Pendant on an unstable surface. It could fall to the ground and be damaged.
- Never place the T20 Pendant close to heat sources or in direct sunlight.
- Avoid exposing the T20 Pendant to mechanical vibrations, excessive dust, humidity, or strong magnetic fields.
- Never clean the T20 Pendant display screen or other surfaces with solvents, abrasive cleaners, or scrubbing sponges.
- Make sure that no foreign objects or liquids can penetrate into the T20 Pendant.

# Related Manuals

Use the following related manuals for reference.

Manual Title	Description
Robot Safety Guide (Cat. No. I590)	Describes how to use the OMRON robot safely.
SmartControllerEX User's Guide (Cat. No. I602)	Describes the V+ language and programming of a control system.
ACE User's Guide (Cat. No. I603)	Detailed descriptions of the keywords in the V+ language.
V+ Language User's Guide (Cat. No. I604)	Describes the V+ operating system. Loading, storing, and executing programs are covered in this guide.
V+ Language References Guide (Cat. No. I605)	Detailed descriptions of the keywords in the V+ language.
V+ Operating System User's Guide (Cat. No. I606)	Describes the V+ operating system. Loading, storing, and executing programs are covered in this guide.
V+ Operating System Reference Guide (Cat. No. I607)	Describes the V+ operating system commands (known as monitor commands).
V+3 User's Manual (Cat. No. I651)	Describes the V+ language and programming of a control system for V+ version 3.x and later.
V+3 Keyword Reference Manual (Cat. No. I652)	Detailed descriptions of the keywords in the V+ language for V+ version 3.x and later.
NJ-series Robot Integrated CPU Unit User's Manual (Cat. No. O037)	Describes the settings and operation of the CPU Unit and programming concepts for OMRON robot control.
Sysmac Studio Version 1 Operation Manual (Cat. No. W504)	Describes the operating procedures of the Sysmac Studio.
Sysmac Studio Integrated Robot System Building Function Operation Manual (Cat. No. W595)	Learning about the operating procedures and functions of the Sysmac Studio to configure Robot Integrated System using Robot Integrated CPU Unit.

# Revision History

---

A manual revision code appears as a suffix to the catalog number on the front and back covers of the manual.

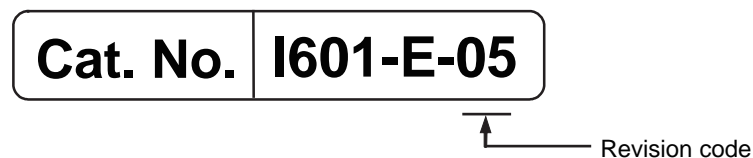

Revision code	Date	Revised content
01	June 2016	Minor specification updates.
02	March 2019	Minor updates for translation.
03	July 2020	Update for NJ-series Robot Integrated CPU Unit.
04	August 2020	Minor corrections and revisions.
05	March 2025	Minor corrections, and revisions.



# 1

## Overview

This section provides general information about the T20 Pendant.

---

<b>1-1</b>	<b>Product Description</b> .....	<b>1-2</b>
<b>1-2</b>	<b>Intended Use</b> .....	<b>1-3</b>
<b>1-3</b>	<b>Features and Components</b> .....	<b>1-4</b>
1-3-1	Pendant Indicators .....	1-4
1-3-2	Keypad Functions .....	1-5
1-3-3	Enable Switch .....	1-6
1-3-4	E-Stop Button .....	1-7
1-3-5	System Emergency Stop Circuitry .....	1-7
<b>1-4</b>	<b>Firmware</b> .....	<b>1-8</b>

# 1-1 Product Description

The T20 Pendant is an optional handheld device that allows the user to interface with a robot without the use of a personal computer. The pendant can be used to manually operate a robot, teach locations, and view V+ programs. It also has the ability to display system status, robot position and mobile I/O communications. The pendant is designed for right or left-handed use and all gripping and holding positions enable comfortable operation.

The T20 Pendant is designed for industrial use and is dust and water resistant. The pendant is equipped with both an E-stop button and Power Enable Switch to ensure safe operation.

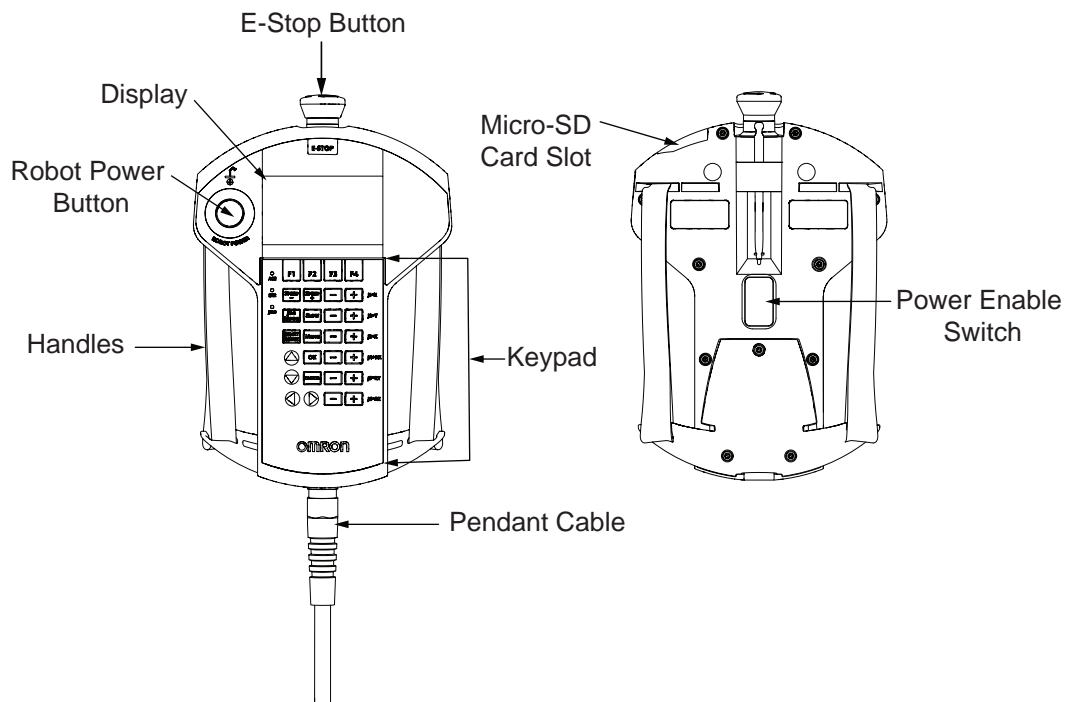

## 1-2 Intended Use

---

The T20 Pendant is intended to be used as a handheld user interface for OMRON Fixed Robots. The T20 Pendant is intended for use by trained personnel only and should not be used by individuals without training and authorization. Using the T20 Pendant to operate the robot arm not within its specified operational limits or misuse of the pendant may lead to serious injuries or damage to equipment. The T20 Pendant is limited to the use of general industrial equipment and must not be used in applications that violate the intended use. You must deploy it only in applications where you anticipate and mitigate potential risks to personnel and equipment. The T20 Pendant should be used in an environment, free from hazards, and with appropriate safety measures in place. It should not be used in environments with flammable or explosive materials, high voltage equipment, or other potential hazards.

# 1-3 Features and Components

The safety features include:

- Emergency stop switch (dual-channel circuit)
- Three-position enable switch that prevents pendant input or robot motion when the switch is not engaged

The software features include the ability to:

- Control the robot by enabling and disabling power and jogging the robot
- Teach locations
- Use Smart Locations, which allow you to work with locations through the *Frame* and *Tool* Screens
- Display robot position, system status, system identification, and error messages
- Display and exchange digital I/O with the robot



## Additional Information

- The pendant cannot exchange digital I/O over the EtherCAT network.
- The T20 Pendant can only move one robot at a time. The pendant can only be connected to a single robot at any given time. A single pendant connection can only control a single robot for systems using an iCS-ECAT or eCS-ECAT controller.

### 1-3-1 Pendant Indicators

Use the following diagram to understand the T20 Pendant controls and indicators.

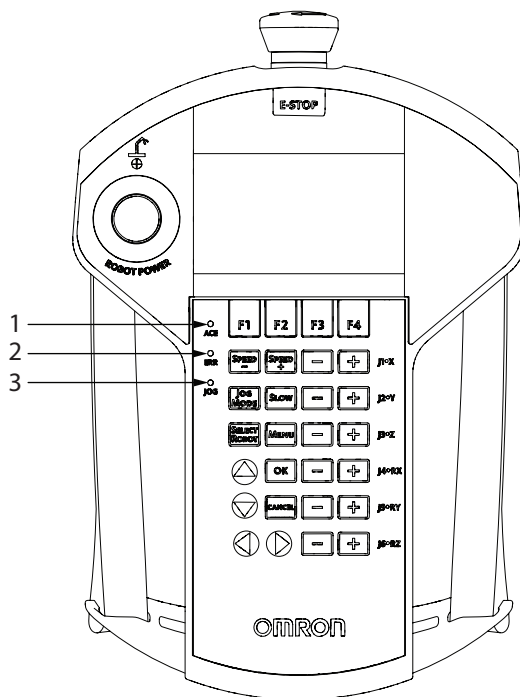

Item	Description
1	ACE LED Reserved for future use





Item	Description
3	JOGMODE Button Press to cycle through COMP, Joint, World, Tool, or Free modes, and then return to COMP Mode. The currently selected mode is displayed in the Jog Mode indicator on the left side of the display screen. A prolonged press on this button will change the mode back to COMP Mode.
4	MENU Button Press to display the Home 1 screen.
5	SELECT ROBOT Button When more than one robot is connected to a SmartController EX, press to cycle through the connected robots. The currently selected robot is displayed in the Selected Robot indicator on the display screen. The T20 Pendant can move multiple robots independently and sequentially, but cannot move multiple robots simultaneously.
6	OK Button Press to select a setting to be changed, to implement a change, or to clear an error message.
7	CANCEL Button Press to return to the previous screen or to clear an error message.
8	Arrow Buttons Press to make selections or to scroll through lists.
9	F1 - F4 Function Buttons When using the display screen, press the function button (F1 to F4 Buttons) that is under the soft key you want to select. For example, from the Home 1 screen, press the F1 Button to select the <i>Disp</i> (Display) soft key.
10	Joint/ Axis Control Buttons Press a '+' Button to move a joint or a Cartesian coordinate in the positive direction. Press a '-' Button to move in the negative direction. These buttons work all the time while power is ON and a jog mode is selected. Multiple joints or Cartesian coordinates can be moved simultaneously by pressing multiple buttons.



#### Additional Information

- The *Menu* Button always returns you to the *Home 1* Screen.
- The software incorporates a button blocking feature, which ignores continued button input while the pendant is processing the current input. This is most notable during the Power ON sequence, which may take a few seconds, during which time the pendant will not respond. This prevents the pendant from suddenly executing a series of queued-up inputs, if you have moved on to a different command screen.

### 1-3-3 Enable Switch

The pendant is equipped with a 3-position enable switch. The enable switch is located on the back of the pendant, as shown in the following figure.

WARNING

Improper use of the pendant can cause hazards. Ensure that you always use the pendant properly, following the instructions in this manual.



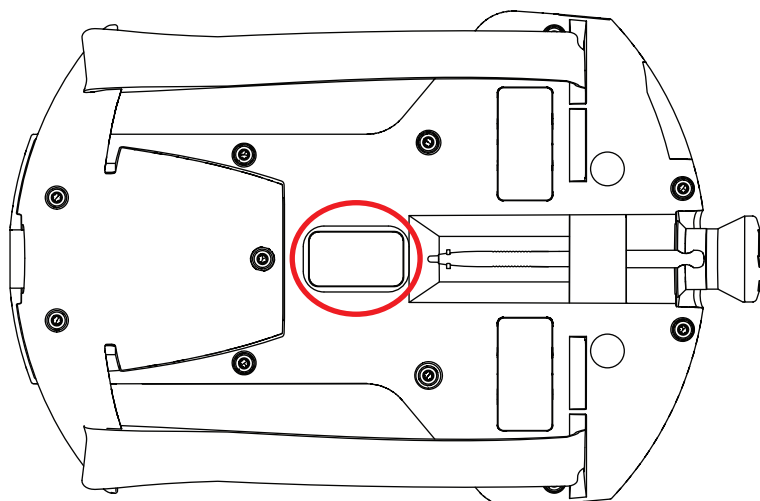

The full-out and full-in positions disable all output, as shown in the following table. In order to enable High Power in Manual mode, the switch must be activated. The High Power Enable Buttons on both the robot and the T20 Pendant function independently. The button on either device can enable/disable power on the system.

Function	Switch Position	Switch Contact
Home	Not pressed (out)	Open
Enable	Partially pressed (half-way, in middle position)	Closed
Panic	Fully pressed (in)	Open

### 1-3-4 E-Stop Button

The E-Stop provided complies with ISO 10218-1 (Clause 5.5.2), with stop category 1 (per IEC 60204). The *E-Stop* Button complies with ISO 13850. The E-Stop meets the requirements of PL-e per ISO 13849.

The *E-Stop* Buttons on the Front Panel and T20 Pendant both function and are individually detected.

### 1-3-5 System Emergency Stop Circuitry

There are two jumpers, or bypass plugs, that can be used with a T20 Pendant system. One is a screw-to-lock T20 Pendant Jumper Plug (Part Number 10048-000) for the pendant adapter cable, included with the T20 Pendant kit. The other is an XMCP jumper plug (Part Number 10052-000) included with the XSYSTEM cable assembly.

The reason for the jumper plugs is that the pendant emergency stop switch and the enable switch are wired into the system emergency stop circuitry. If the T20 is not connected and there is no jumper plug in the T20 cable, the system emergency stop circuitry will see this as an E-Stop having been activated, and you cannot enable High Power.

To prevent this, when either the pendant cable or the adapter cable will be unplugged, the corresponding jumper plug must be installed.

## 1-4 Firmware

---

The T20 Pendant will work with a robot that runs V+ firmware. The T20 Pendant must be running version 3.0.0.15 firmware when being operated with the iCS or eCS.

A T20 Pendant with version 3.0.0.15 firmware will also support eAIB, SmartController EX, eMB-40, and eMB-60 controllers running 2.4C12 or later. The T20 Pendant must be upgraded to at least 2.4.3.4 firmware to work with a controller running 2.4C12 or later.



# Specifications

This section provides specifications for the T20 Pendant and other associated items.

---

<b>2-1</b>	<b>General Specifications .....</b>	<b>2-2</b>
<b>2-2</b>	<b>Dimensions .....</b>	<b>2-3</b>
<b>2-3</b>	<b>Transport and Storage .....</b>	<b>2-4</b>

## 2-1 General Specifications

Description	Specification
Weight (without connector)	480 g
Ingress Protection	IP65
Shock Resistance (operating)	25 g / 11 ms (IEC 60068-2-27)
Display Type	High-resolution color OLED display
Construction	Steel panel housing, blue zinc-coated surface. Withstands grease, oil, alcohol, and lubricants.
Flammability Class	UL94-V0
Operating Temperature	0 to 45°C
Storage Temperature	-25 to 60°C
Relative Humidity (non-condensing)	5% to 95%



### CAUTION

Do not use the T20 Pendant in hazardous environments (explosive gas, water, dust, oil, or mist), in mining operations, or outdoors. It has an IP rating of IP65.



## 2-2 Dimensions

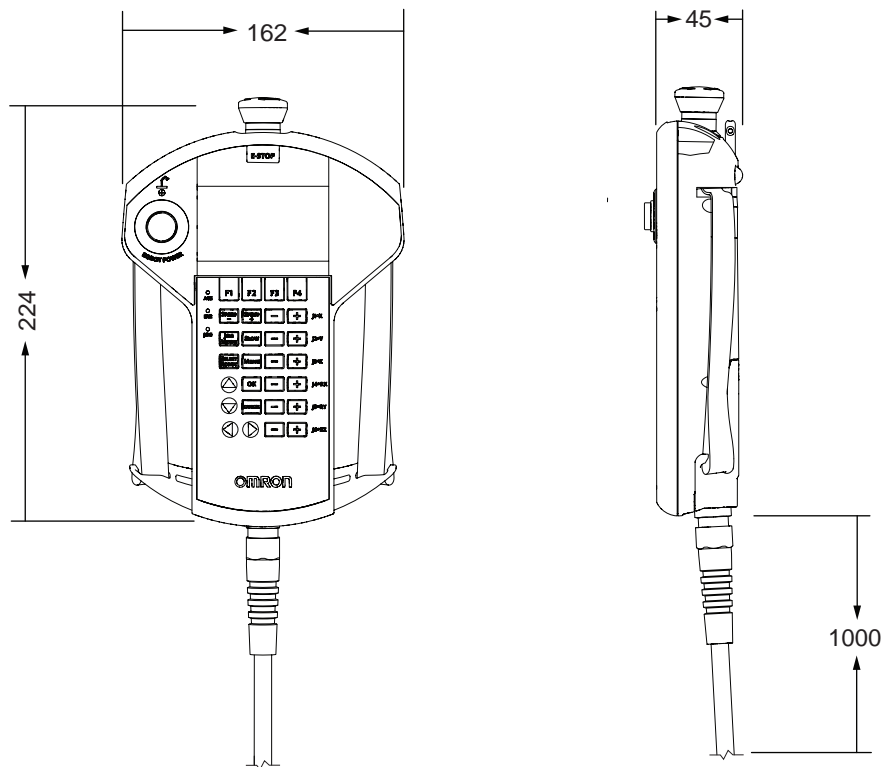

## 2-3 Transport and Storage

---

The T20 Pendant must be shipped and stored in a temperature controlled environment, within the range  $-25$  to  $+60^{\circ}\text{C}$  ( $-13$  to  $140^{\circ}\text{F}$ ). The recommended humidity range is 5% to 95%, non-condensing. It should be shipped and stored in the original packaging, which is designed to prevent damage from normal shock and vibration. You should protect the packaging from excessive shock and vibration. The pendant must always be stored and shipped in a clean, dry area that is free from condensation. When storing the T20 Pendant inside a cabinet there must be a cutout hole into the cabinet for the T20 Bypass Plug that is  $25+0.1$  mm in diameter. The maximum wall thickness through which this hole is cut should be 6.5 mm.



# 3

## Operation

This section provides information about the operation of the AMR.

---

<b>3-1</b>	<b>Connecting the T20 Pendant.....</b>	<b>3-3</b>
3-1-1	Connecting the T20 Directly to the Robot .....	3-3
3-1-2	Connecting the T20 to the Robot with the SmartController EX .....	3-4
<b>3-2</b>	<b>Enabling Robot Power .....</b>	<b>3-6</b>
3-2-1	Turning High Power ON .....	3-6
3-2-2	Disabling High Power from T20 Pendant .....	3-7
<b>3-3</b>	<b>User Interface Operation .....</b>	<b>3-8</b>
3-3-1	User Interface Controls .....	3-8
3-3-2	Displaying the Home Screens .....	3-9
<b>3-4</b>	<b>Using Jog Mode.....</b>	<b>3-11</b>
3-4-1	COMP Mode.....	3-11
3-4-2	Joint Mode.....	3-11
3-4-3	World Mode .....	3-12
3-4-4	Tool Mode.....	3-13
3-4-5	Free Mode .....	3-14
<b>3-5</b>	<b>Speed Control.....</b>	<b>3-15</b>
3-5-1	Speed Indicator .....	3-15
3-5-2	Setting the Initial Speed .....	3-15
<b>3-6</b>	<b>Position Display .....</b>	<b>3-17</b>
<b>3-7</b>	<b>Smart Locations .....</b>	<b>3-18</b>
<b>3-8</b>	<b>Available Frames .....</b>	<b>3-21</b>
3-8-1	Enable Frame-Based Jogging .....	3-21
3-8-2	Frame Jogging Mode .....	3-21
<b>3-9</b>	<b>Available Tools .....</b>	<b>3-23</b>
<b>3-10</b>	<b>Location Teaching.....</b>	<b>3-24</b>
3-10-1	How to Teach a Location .....	3-25
3-10-2	How to Select an Array.....	3-25
3-10-3	Adding Approach Distance.....	3-26
3-10-4	Using JOG TO .....	3-26
3-10-5	Align .....	3-26
<b>3-11</b>	<b>I/O Signals.....</b>	<b>3-27</b>
3-11-1	Controlling the I/O Signals.....	3-27
<b>3-12</b>	<b>Displaying and Clearing Errors .....</b>	<b>3-29</b>

<b>3-13</b>	<b>System Maintenance Screen</b> .....	<b>3-30</b>
<b>3-14</b>	<b>Screen Saver Settings</b> .....	<b>3-31</b>
<b>3-15</b>	<b>Enabling Smart Locations</b> .....	<b>3-32</b>
<b>3-16</b>	<b>Setting Approach Distance</b> .....	<b>3-33</b>
<b>3-17</b>	<b>Enabling Pendant Message</b> .....	<b>3-34</b>
<b>3-18</b>	<b>System Information Screen</b> .....	<b>3-35</b>
3-18-1	<b>Displaying System Information</b> .....	<b>3-35</b>
<b>3-19</b>	<b>Displaying Recent Errors</b> .....	<b>3-36</b>
<b>3-20</b>	<b>Updating the Pendant Firmware</b> .....	<b>3-38</b>
<b>3-21</b>	<b>Loss of Communication</b> .....	<b>3-39</b>

## 3-1 Connecting the T20 Pendant

The following sections describe how to connect the T20 Pendant to a robot with and without a Smart-Controller EX.

### 3-1-1 Connecting the T20 Directly to the Robot

To directly connect the T20 Pendant to the robot you must connect the XSYSTEM Cable to the robot and then connect the T20 Pendant to the XSYSTEM Cable with the T20 Pendant Adapter Cable. When the pendant is not in use the T20 Pendant Jumper Plug must be placed either at the end of the T20 Pendant Adapter Cable or directly to the XMCP connector. The robot will not operate without a T20 Pendant Jumper Plug in place.

The following figure shows how to connect the T20 Pendant to the robot with the XSYSTEM cable. This cable is supplied with the robot.

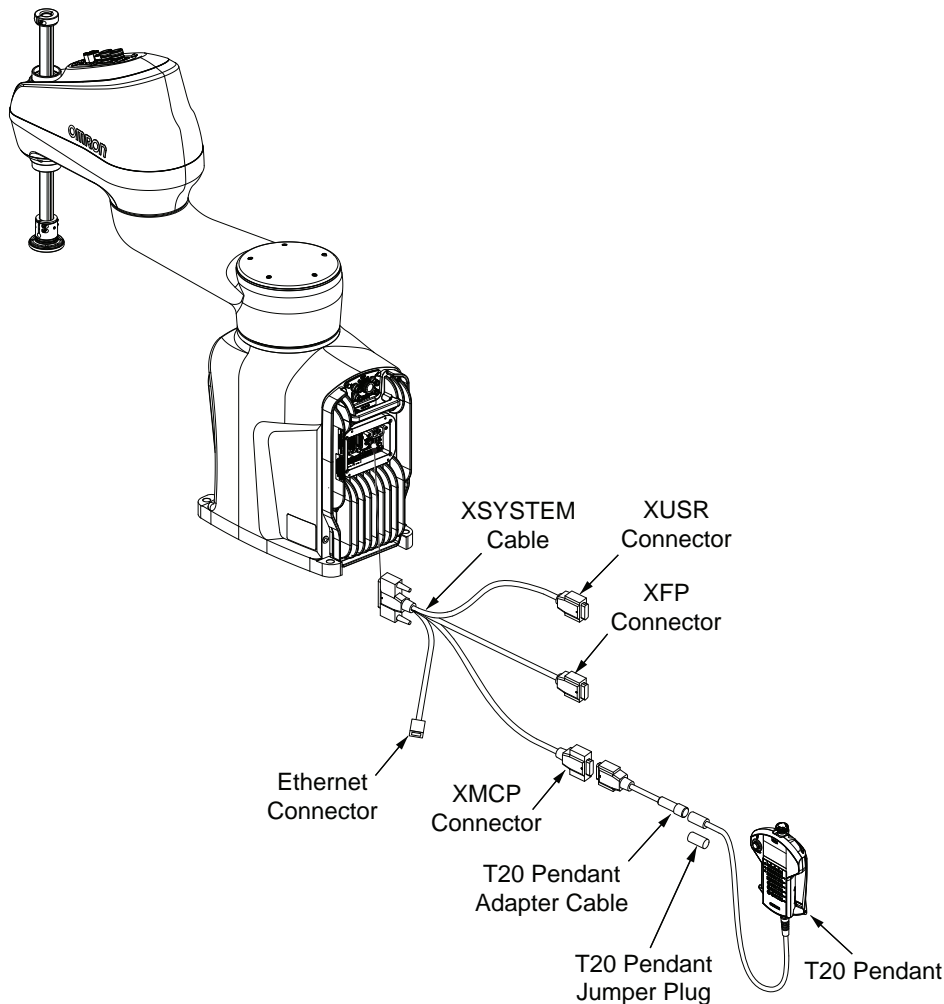

There can be as many pendants in the system as there are robots. Therefore, each pendant is only controlling the robot it is directly connected to. It won't be possible to connect to, select, or control any other robot with the pendant. The pendant needs to be plugged directly into the robot in order to control it, even if other robots are on the EtherCAT network.

To control multiple robots with one pendant you must connect the T20 Pendant to the robots with a Smart Controller EX.



**Additional Information**

Refer to the robot's user manual for additional information about connecting the T20 Pendant and optional hardware to the robot.

**3-1-2 Connecting the T20 to the Robot with the SmartController EX**

The SmartController EX power must be turned OFF when connecting the T20 Pendant. After the T20 Pendant is connected, power ON the SmartController EX and wait for the boot-up sequence to finish before operating the Pendant.

The following figure shows a Front Panel and an T20 Pendant connected to a SmartController EX motion controller.

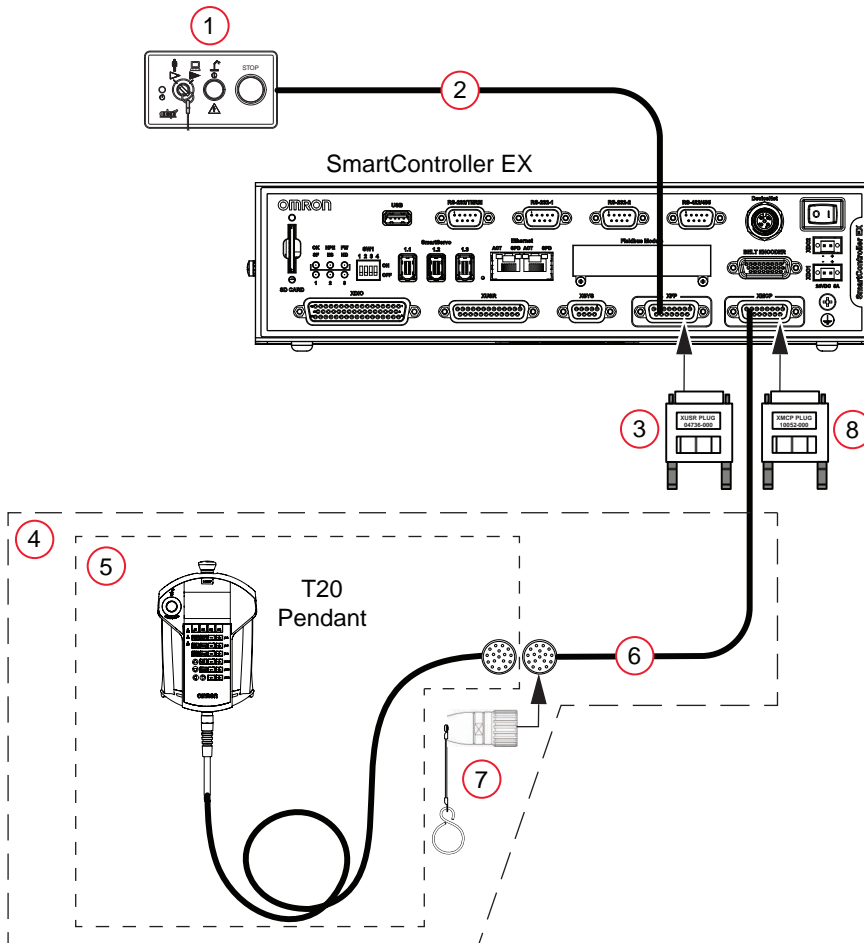

**Precautions for Correct Use**

A Front Panel or Front Panel Jumper Plug must be connected to the XSYSTEM XFP cable or to the SmartController EX. A T20 Pendant, T20 Pendant Bypass Plug, or XMCP Jumper Plug must also be connected.

Item	Description	Part Number
1	Front Panel	90356-10358
2	Front Panel Cable (3 m)	10356-10500

Item	Description	Part Number
3	Front Panel Jumper Plug	04736-000
4	T20 Pendant Kit	10046-010
5	T20 Pendant Assembly	10054-010
6	T20 Pendant Adapter Cable (3m)	10051-003
7	T20 Pendant Bypass Plug	10048-000
8	XMCP Jumper Plug	10052-000



#### Additional Information

Items 1 and 2 are included with most OMRON robots. Items 3 and 8 are included with the SmartController EX. Item 4 includes items 5, 6, and 7.

## 3-2 Enabling Robot Power

---

This section discusses how to enable the robot power in both Auto and Manual Modes, as well as after an E-Stop Button is pressed. This is also referred to as enabling High Power.

Enabling the robot energizes all robot servo motors. When the robot is enabled, it is capable of moving.



### Additional Information

---

When power is disabled, the pendant automatically changes to *COMP* mode, and cannot change out of *COMP* mode. The Power Button is functional even when the screen saver is on. Pressing any other button only clears the screen saver.

---

### 3-2-1 Turning High Power ON

The Robot Power light uses the same blinking pattern as the Front Panel: A fast blink appears when the Enable Switch is released in Manual Mode. A slow blink appears when the V+ Enable Power command has been issued from the user terminal, executing program, or pendant.

#### Auto Mode

---

Use the following procedure to turn High Power ON in Auto Mode.

- 1** Make sure the Auto/Manual Mode key switch on the Front Panel is set to Auto Mode.
- 2** Press and release the Robot Power Button on the pendant. After a few seconds, High Power to the robot turns ON, and the Robot Power Button on the pendant lights.

#### Manual Mode

---

Use the following procedure to turn High Power ON in Manual Mode.

- 1** Make sure that the Auto/Manual key switch on the Front Panel of the robot is set to Manual Mode. If any errors occur, the ERR LED will illuminate. Press the OK Button or Cancel Button to clear errors.
- 2** Press and release the Robot Power Button on the pendant.
- 3** Press the pendant Enable Switch to the middle position. After a few seconds, High Power to the robot turns ON, and the Robot Power Button on the pendant lights.



### Additional Information

---

When enabling power in Manual Mode, the pendant will display a notification screen that requests that user press and hold the pendant Enable Switch.

---

## After an E-Stop

Use the following procedure to turn ON High Power after pressing the pendant Emergency Stop (E-Stop) Button.

- 1** Twist the E-Stop Button to the right (clockwise). The button is spring-loaded and will return to its normal position. If any errors occur, the ERR LED lights. Press the OK Button or Cancel Button to clear errors.
- 2** Press the Enable Switch (to its enable position) to turn ON High Power.

## After Enable Switch is Released

When the system is set to *Manual* Mode and you release the Enable Switch (or select the "panic" position), the system turns off in a controlled manner. This puts the system in a different state than when the E-Stop Button is pressed.

Use the following procedure to turn ON High Power when the pendant is in this controlled state.

- 1** Press the Enable Switch (to its enable position). If any errors occur, the ERR LED will illuminate. Press the OK Button or Cancel Button to clear errors.
- 2** Press and release the Robot Power Button to turn ON High Power.

### 3-2-2 Disabling High Power from T20 Pendant

Use one of the following three options for disabling High Power from the T20 Pendant.

- Press Robot Power Button
- Press the E-Stop Button
- Release or fully press the Enable Switch (only available when the system is in *Manual* mode)

## 3-3 User Interface Operation

This section describes how to use the T20 user interface.

### 3-3-1 User Interface Controls

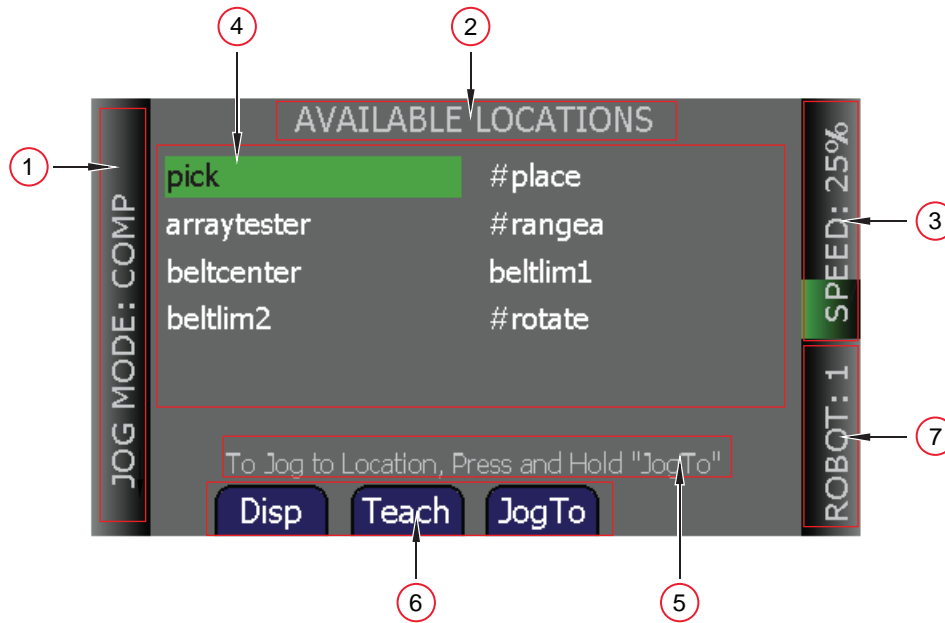

Item	Indicator	Description
1	Jog Mode Indicator	Displays the currently selected <i>Jog Mode: COMP, Joint, World, Tool, or Free</i> . This indicator flashes when the jog mode changes.
2	Current Screen Title	Displays the name of the currently displayed screen.
3	Speed Indicator	Displays the current robot speed setting as a percentage of maximum monitor speed (COMP Mode) or jog speed (non-COMP modes). Also, the green speed gauge increases or decreases in size to indicate higher or lower speed, respectively. While slow speed is active, maximum slow-mode speed is 20% of maximum monitor or jog speed, depending on the jog mode selected.
4	Main Display Area	Displays information about the robot and errors.
5	User Message Area	Displays user messages, such as operating instructions.
6	Soft Key Labels	Displays the labels of the soft keys associated with the currently displayed screen. In some circumstances, soft key labels will be displayed, but will not be available. They will be blue if available, and grey if not.
7	Selected Robot Indicator	Displays the currently selected robot. The currently selected robot is the robot that can be moved and monitored by the software. (This indicator is only applicable when more than one robot is connected to a SmartController EX motion controller.) This indicator flashes when the robot number changes.



### 3-3-2 Displaying the Home Screens

Pressing the Menu Button on the T20 Pendant displays the Home 1 screen as shown below. There are three Home screens. Press the F4 Button to select *Next >* to step through each screen.



The following table describes the soft keys shown on the Home 1 screen. The soft keys are used for quick access to the different screens and functions on the T20 Pendant.

Soft Key	Description
<b>Disp</b>	Accesses the current World or Joint position screens. It also allows you to open and close the gripper.
<b>Loc</b>	Accesses the available locations and associated commands (such as a pick or place), Teach, JogTo, Align, and New functions.
<b>I/O</b>	Accesses the Type and Toggle functions, which allow you to select the type of I/O, and toggle the selected signal ON or OFF.
<b>Next &gt;</b>	Access the Home 2 screen, which displays additional soft keys.



The following table describes the soft keys shown on the Home 2 screen. The soft keys are used for quick access to the different screens and functions on the T20 Pendant.

Soft Key	Description
Frame	Allows displaying available frames and selecting a frame for movement.
Tool	Allows displaying available tools and displaying and setting the current tool.
Step	Reserved for future use.
Next >	Access the Home 3 screen, which displays additional soft keys.



The following table describes the soft keys shown on the Home 3 screen. The soft keys are used for quick access to the different screens and functions on the T20 Pendant.

Soft Key	Description
Maint	Accesses the <i>System Maintenance</i> Screen, for setting screen saver, initial speed, Smart Locations, Approach Distance, Pendant Messages, System Information, Error Functions, and Firmware Updates on the pendant.
Next >	Returns to the Home 1 screen.

## 3-4 Using Jog Mode

Jog Mode and the Jog Control Buttons allow you to position the connected or selected robot. The Jog Modes are available in the following order: COMP (computer), Joint, World, Tool, and Free. When High Power is enabled and the robot is calibrated, press the Jog Mode Button to step through these modes in sequential order. The selected mode is displayed in the Jog Mode Indicator. When any of these modes other than COMP is active, the Jog LED will illuminate. You can use the Jog Control feature while any of the software screens are displayed.

### 3-4-1 COMP Mode

In COMP Mode, an executing program or the system terminal has control of the robot. To select COMP Mode, press the Jog Mode Button until *COMP* is displayed in the Jog Mode Indicator.



#### Additional Information

You cannot use jog control to move a robot while in COMP Mode.

### 3-4-2 Joint Mode

When Jog Mode is selected, movement is about the axis of the specified joint. The following figure shows a robot with three rotational joints (Joints 1, 2, and 4) and one translational joint (Joint 3). Positive rotation of Joints 1 and 2 is counterclockwise as viewed from above. Positive rotation of Joint 4 is clockwise as viewed from above. Positive movement of Joint 3 is downward.

Different robots or motion devices will have different joint numbers assigned to their joints. When you first move an unfamiliar robot using Jog Mode, set the Jog Speed to 10 or lower, put the robot in a safe area, and carefully move the robot using the different joint numbers to verify how the pendant moves the robot. See the documentation for the motion devices you are using for details on their joint assignments.

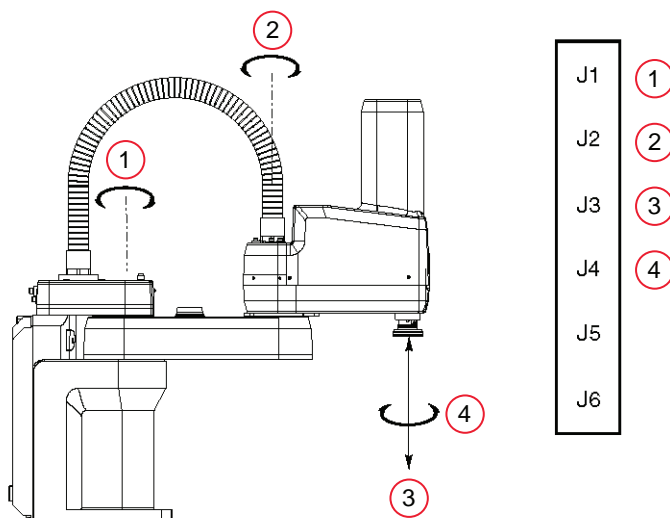

Item	Description
1	Joint 1
2	Joint 2

Item	Description
3	Joint 3
4	Joint 4

## Positioning in Joint Mode

Use the following procedure to position the robot while in Joint Mode.

- 1 Press the Jog Mode Button until *Joint* is displayed in the Jog Mode Indicator.
- 2 Press and hold the '+' Button to move the robot joint in the positive direction; press and hold the '-' Button to move the robot joint in the negative direction.

### 3-4-3 World Mode

When *World* is selected in the JOG Mode Indicator, movement in the X, Y, or Z direction is parallel to an axis of the World Coordinate System.

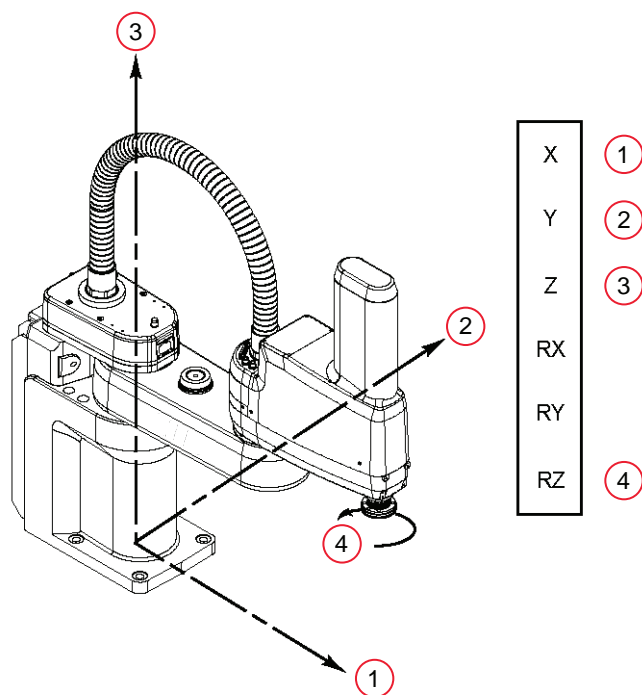

Item	Description
1	+X (X Direction)
2	+Y (Y Direction)
3	+Z (Z Direction)
4	+RZ, CCW (RZ Rotation)

## Positioning in World Mode

Use the following procedure to position the robot while in World Mode.

- 1 Press the Jog Mode Button until *World* is displayed in the Jog Mode Indicator.

- 2 Press and hold the '+' Button to move the robot tool flange in the positive direction; press and hold the '-' Button to move the flange in the negative direction.

### 3-4-4 Tool Mode

When *Tool* is selected in the JOG Mode Indicator, movement in the X, Y, or Z direction is along an axis of the Tool Coordinate System. The Tool Coordinate System is centered at the robot tool flange with the Z-axis pointing away from the flange. On most robots, the positive X-axis is aligned with the center of the tool flange keyway.

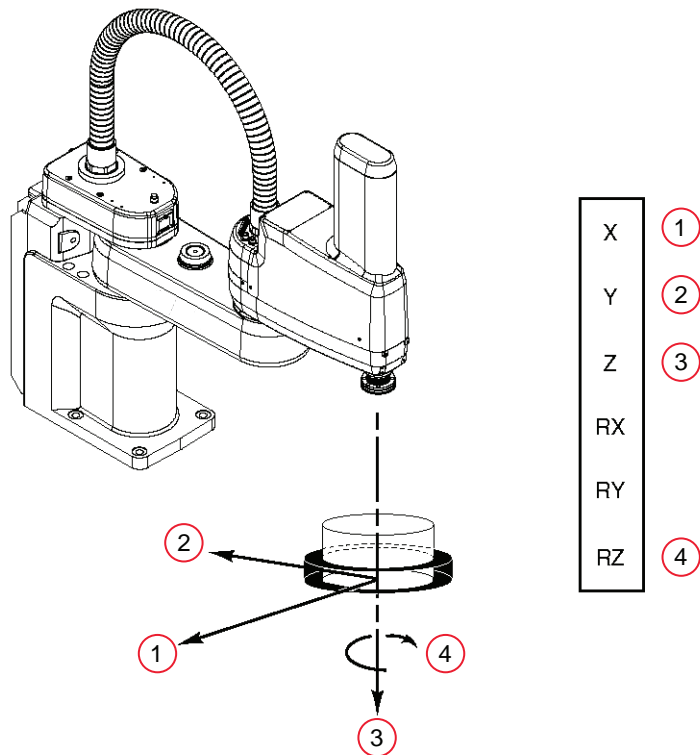

Item	Description
1	+X (X Direction)
2	+Y (Y Direction)
3	+Z (Z Direction)
4	+RZ (Rotation About Tool Z Axis)



#### Additional Information

The previous drawing assumes that the tool transformation is set to null (all values are 0). If a tool transformation is in effect, the tool coordinate system will be offset and rotated by the value of the tool transformation. Any motion in *Tool* mode will now be relative to the offset coordinate system, and not the center of the tool flange.

## Positioning in Tool Mode

Use the following procedure to position the robot while in Tool Mode.

- 1 Press the Jog Mode Button until *Tool* is displayed in the Jog Mode Indicator.

- 2 Press and hold the '+' Button to move the robot tool flange in the positive direction; press and hold the '-' Button to move the flange in the negative direction. In a four-axis robot, positive rotation of the gripper (RZ) is clockwise as viewed from above.

### 3-4-5 Free Mode

When *Free* is selected in the JOG Mode Indicator, the motor torque will be zeroed and the brake (if any) for the selected joint will be released. You can make multiple selections with the Joint/Axis Control Buttons to release as many joints as required.

To select Free Mode, press the Jog Mode Button until *Free* is displayed in the Jog Mode Indicator. As soon as another jog control mode is selected, all joints are returned to servo control and will not move freely.

On some robots, Free Mode is disabled for some of the joints.

The joint assignments in Free Mode are the same as the joint assignments in Joint Mode. Refer to the preceding figure in 3-4-2 *Joint Mode* on page 3-11.

## WARNING

When a joint is selected using the Joint/Axis control buttons while in Free Mode, the corresponding joint is released and moves freely (in some mechanisms, multiple joints may be released). In many cases, the weight on the joint will be sufficient to move the joint and cause equipment damage or injury to personnel in the workspace.



## Positioning in Free Mode

Use the following procedure to position the robot in Free Mode.

- 1 Press the Jog Mode Button until *Free* is displayed in the Jog Mode Indicator.
- 2 Press and hold the Enable Switch in the middle position to enable output.
- 3 Press the '+' Button of the selected Joint/Axis position to release the joint.
- 4 Manually move the joint to the desired position.
- 5 Press the '-' Button of the selected Joint/Axis position to lock the joint.



### Additional Information

The Enable Switch must be held in the middle position to release or lock a joint.

## 3-5 Speed Control

When using JOG Mode you can change the robot speed using the Speed +, Speed -, and Slow Buttons. The selected speed will be applied when you use the jog controls to move the robot.

Jog Speed is the percentage of the speed in manual mode, which is configurable in the ACE or Sysmac Studio software with the manual control maximum speed parameter.



### Additional Information

In COMP Mode you cannot use the pendant to control the robot's speed.

### 3-5-1 Speed Indicator

The Speed Indicator is located on the right-hand side of the T20 Pendant's screen. It displays the current Robot Speed setting as a percentage of maximum monitor speed or jog speed. The green gauge of the Speed Indicator increases in height when the speed is increased, and decreases in height when the speed is decreased.

When Slow Speed is active, a red horizontal line and hash marks are displayed in the part of the speed indicator above 20%. This represents that the robot is limited to 20% of the maximum speed.



### Additional Information

- In COMP Mode, the Speed Control and Speed Indicator pertain to Monitor Speed.
- In other modes, the Speed Control and Speed Indicator pertain to Jog Speed.

### 3-5-2 Setting the Initial Speed

You can select Normal or Slow as the default speed setting when the system starts up. The pendant comes with Normal as the default speed setting.

Use the following procedure to select the initial speed.

- 1 Ensure you are not in COMP Mode. To set the initial speed you must be in Joint, World, or Tool mode.

- 2** From the Home 1 screen, press the F4 Button twice to select *Next >* twice to display the Home 3 screen.
- 3** Press the press the F1 Button to select *Maint.* The System Maintenance screen opens.
- 4** Press the up/down arrow buttons to select the *Initial Speed* field. Press the OK Button.
- 5** Press the up/down arrow buttons to select either *Normal* or *Slow* for the initial speed.
- 6** Press the OK Button to accept the change.



## 3-6 Position Display

To display coordinate information about the robot's current position, press the F1 Button to select *Disp.* The coordinates for the robot's current location are displayed.



- Press the F1 Button to select *Disp.* to toggle the display between the *Current World Position* and *Current Joint Position* screens.
- Press the F2 Button to select *Grip* to open and close a gripper installed on the tool flange.
- Press the F3 Button to select *Loc* to display the *Available Locations* screen.

## 3-7 Smart Locations

When Smart Locations is enabled the pendant displays all locations that have the string “tool” in them on the *Available Tools* screen, all locations that have the string “frame” in them in the *Available Frames* screen, and all locations that don’t match “tool” or “frame” in the *Available Locations* screen. If the option is disabled, all locations are shown on all three screens.

To enable the Smart Locations feature refer to *3-15 Enabling Smart Locations* on page 3-32

The following images show the *Available Frames*, *Available Locations*, and *Available Tools* screens when Smart Locations is enabled.

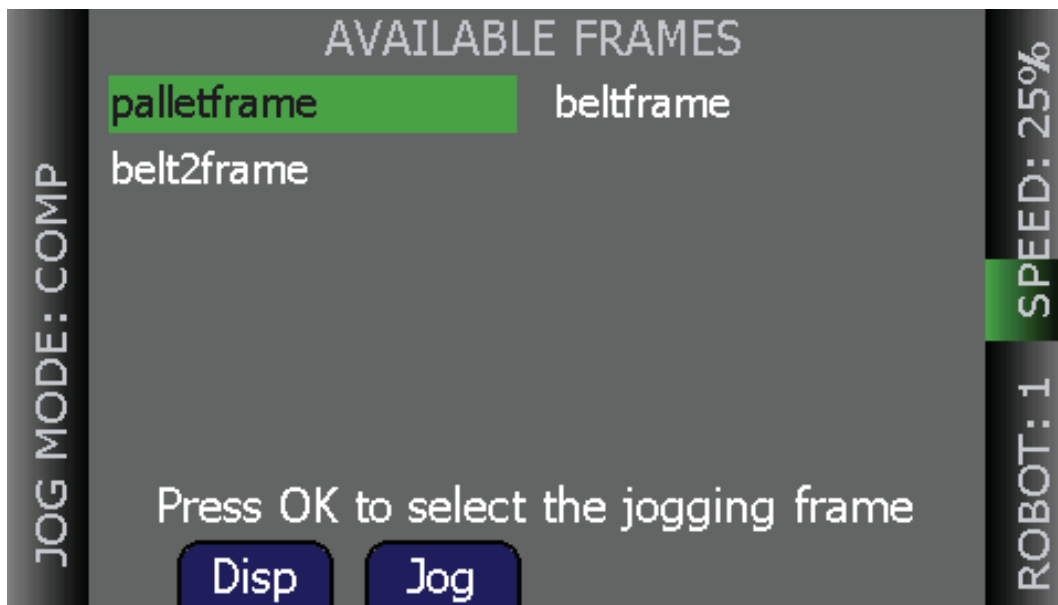



The following images show the *Available Frames*, *Available Locations*, and *Available Tools* screens when Smart Locations is disabled.

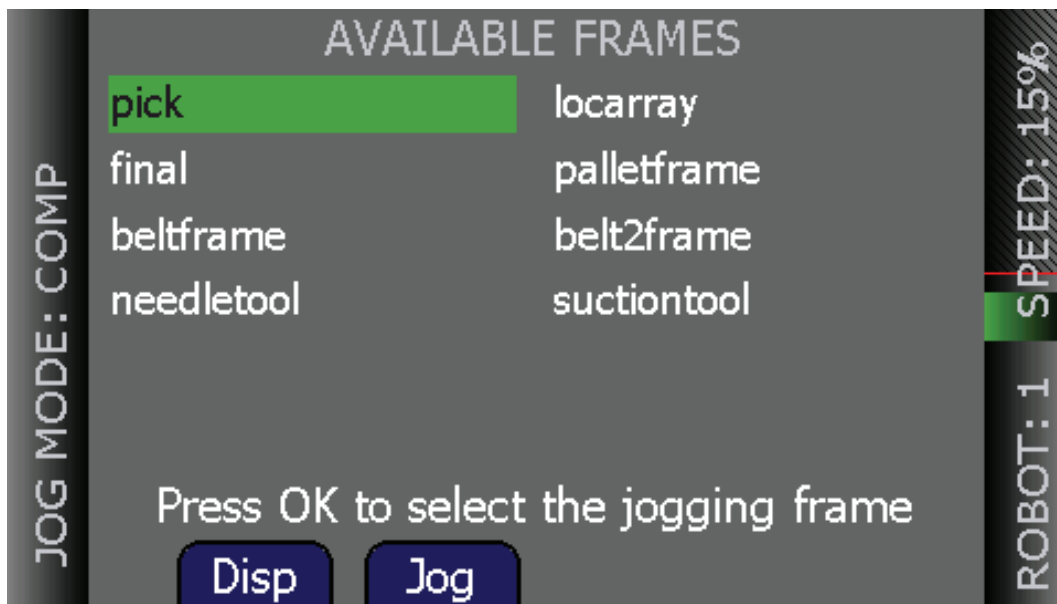

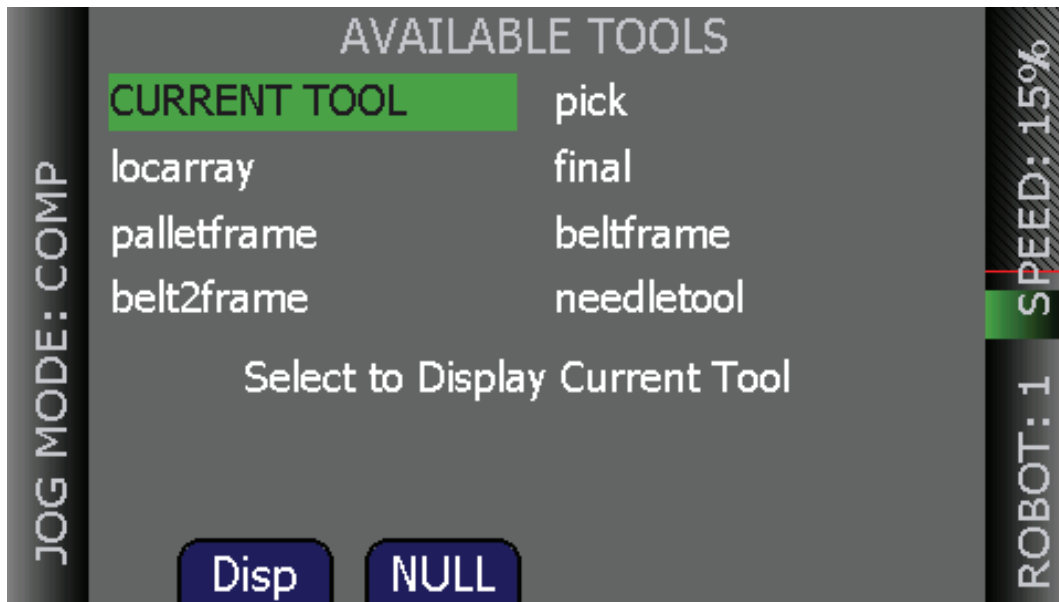
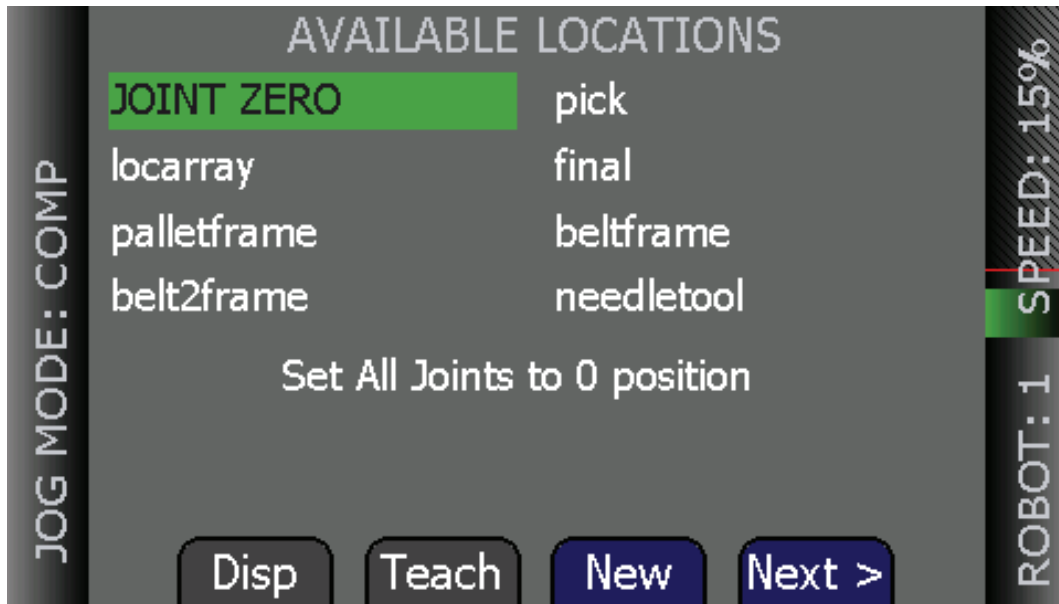

## 3-8 Available Frames

The *Available Frames* screen is used to set the jog mode relative to the selected frame. This is the only way to enter the Frame Jog Mode. When this is done, the Jog Controls will move the robot in relation to the selected frame, rather than the World Coordinates.

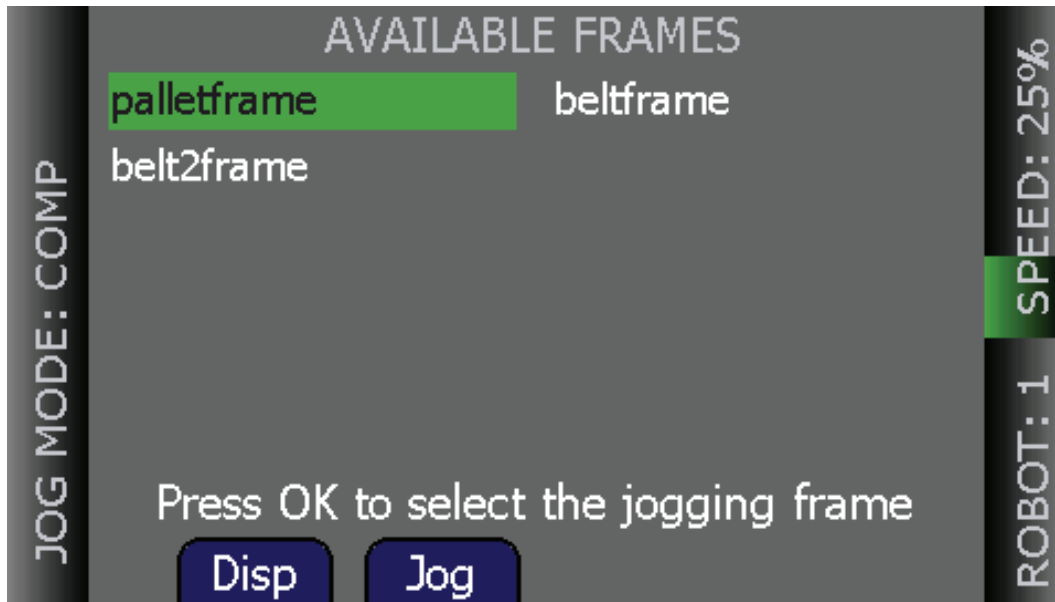

### Additional Information

Once you use Jog Mode to cycle to another mode, you cannot return to Frame Mode without going back to this screen.

### 3-8-1 Enable Frame-Based Jogging

Use the following procedure to set the system to jog in Frame Mode (this is displayed as *JOG REL: <FrameName>*).

- 1** From the Home 2 screen, press the F1 Button to select *Frame* to open the *Available Frames* screen.
- 2** Use the arrow buttons to select the desired frame.
- 3** Press the F2 Button to select *Jog* to enable jogging based on the selected frame.

### 3-8-2 Frame Jogging Mode

When locations are taught while in Frame Mode (see the previous section), they are taught relative to the selected frame. When locations are jogged to while in Frame Mode, they are jogged relative to the currently selected frame.

This feature was designed to allow you to teach, and then jog to locations relative to another frame, such as a palette, all from the pendant. However, it does provide the opportunity for confusion: The most likely user error here would be to teach a position in "*JOG REL: <FrameName>*", then change

jog modes, and later try to jog to the new position while in World Mode. This error would produce either no movement (if the position is unreachable) or, possibly, movement to an arbitrary location, because the relative frame is no longer involved.

## 3-9 Available Tools

The *Available Tools* screen provides the ability to view and set a tool transformation or offset.

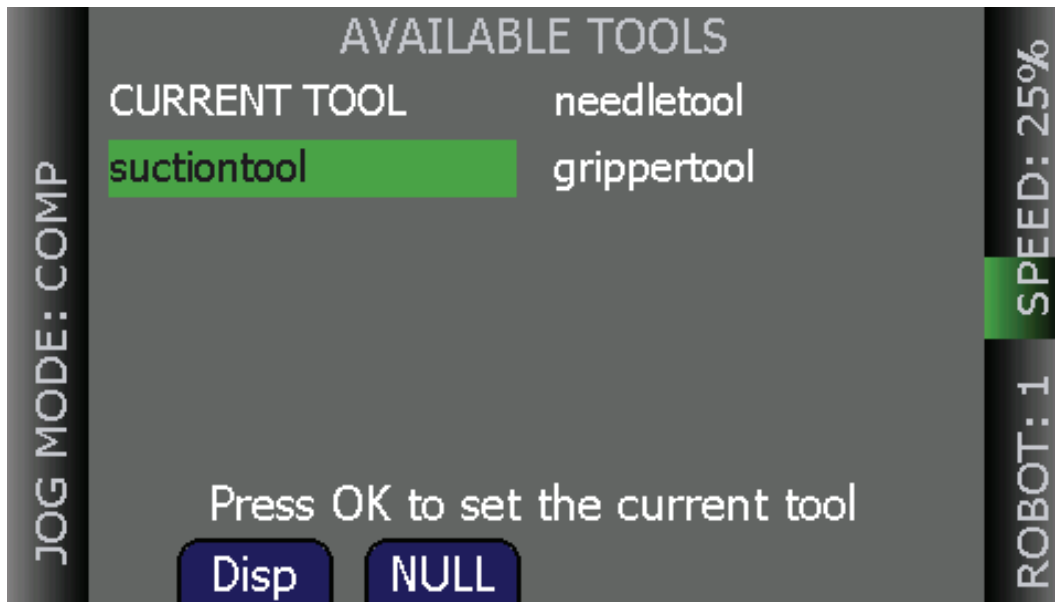

While on this screen, you can:

- Press the F1 Button to select *Disp.* to display the value of the selected tool transformation (you can select *CURRENT TOOL* to display the current tool transformation). After you display a tool (other than *CURRENT TOOL*), pressing the F1 Button to select *Disp.* will then toggle between that tool and the current tool, which allows you to see if it is the selected tool.
- To set a tool select the desired tool from the list and press the OK Button to set it.
- Press the F2 Button to select *NULL* to set the current tool transformation, or offset, to *null tool* (no tool offset frame in use).

## 3-10 Location Teaching

Press the F2 Button to select *Loc* from the Home 1 screen to display the *Available Locations* screen shown in the following figure.

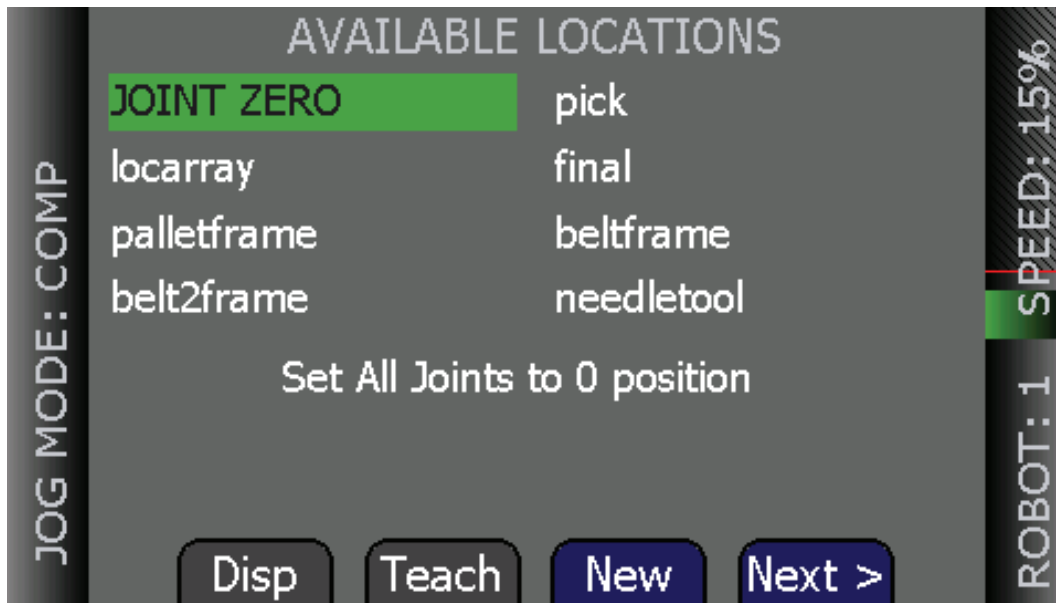

The following table describes the soft keys shown on the *Available Locations* screens.

Soft Key	Description
<i>Disp</i>	Shows the current position of the robot.
<i>Teach</i>	Teaches the current position to the selected location.
<i>New</i>	Creates a new location named <i>pendant.loc[X]</i> where X is the first available value (1,2,3...).
<i>JogTo</i>	Press and hold to move (jog) the robot to the selected position.
<i>Appro</i>	Press to bring the robot to the approach position for the selected location. The approach position is the location less 'A' mm along the Z-axis of the tool transformation (or offset), where 'A' is the approach distance set on the <i>System Maintenance</i> screen.



Soft Key	Description
<i>Align</i>	Aligns the robot tool Z-axis with the nearest world axis.
<i>Next&gt;</i>	Advance to the next <i>Available Locations</i> screen.

### 3-10-1 How to Teach a Location

Use the following procedure to teach a location.

- 1** From the *Available Locations* screen, press the arrow buttons to select the desired location from the list of locations.
- 2** Press the F2 Button to select *Teach*. The *TEACH pick* screen opens for the selected location.
- 3** Use the jog controls to position the robot at the desired location.
- 4** When the robot is at the desired location, press the OK Button to teach the position.



#### Additional Information

To store a taught position for later use, it must be saved to the permanent memory of the robot's control system. Refer to the *Automated Control Environment (ACE) Version 4 User's Manual (Cat. No. I633)* or *Sysmac Studio Robot Integrated System Building Function with Robot Integrated CPU Unit Operation Manual (Cat. No. W595)* for additional information about saving a configuration.

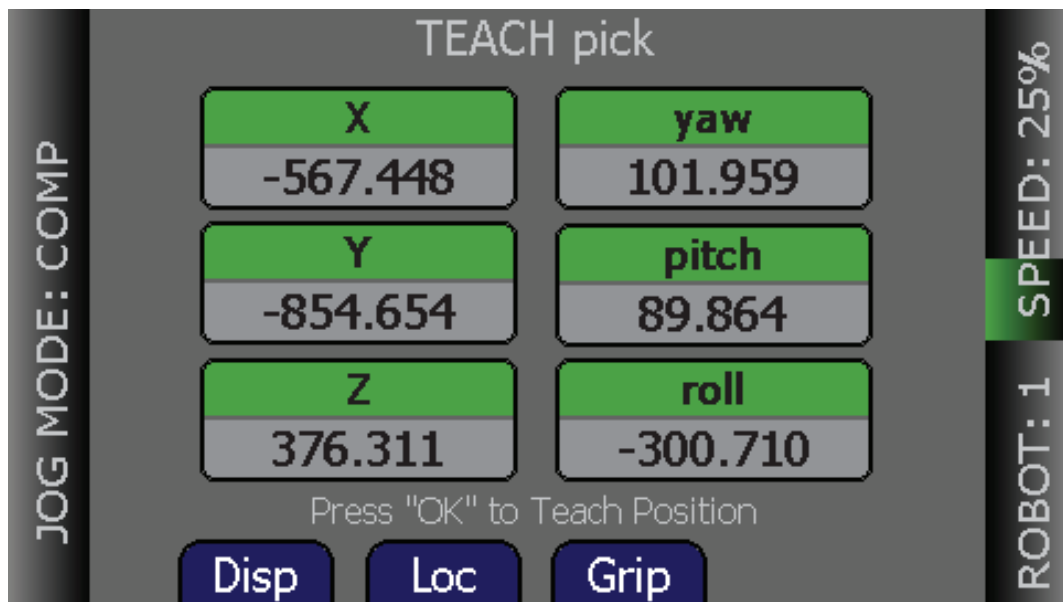

### 3-10-2 How to Select an Array

Use the following procedure to select an array.

- 1** From the *Available Locations* screen, press the up/down arrow buttons to select the desired array, and then press the F2 Button to select *Expand*. The valid members of the selected array are displayed.

- 2 Press the up/down arrow buttons to select the desired location. Press the Cancel Button to return to the previous screen.

### 3-10-3 Adding Approach Distance

You can specify an approach distance through the *System Maintenance* screen. For details, see 3-16 *Setting Approach Distance* on page 3-33.

After the approach distance is set, you can use the F2 Button to select *Appro* to bring the robot to the approach position for the selected location. The approach position is the location less 'A' mm along the Z-axis of the tool transformation (or offset), where 'A' is the approach distance set on the *System Maintenance* screen.

### 3-10-4 Using JOG TO

Use *Jog To* to move the robot to a selected location (stored in memory). Use the following procedure to jog the robot to a location.

- 1 While the Home 1 screen is displayed, press the F2 Button to select *Loc* to display the *Available Locations* screen.
- 2 Press the arrow buttons to select the desired location.
- 3 Press and hold the F1 Button to select *Jog To* until the robot is at the desired location. Release the button.



#### Additional Information

---

The predefined *JOINT ZERO* location, sets the robot to *#PPOINT (0,0,0,0,0,0)*.

---

### 3-10-5 Align

While the *Available Locations* screen is displayed, you can select a location and then press the F3 Button to select *Align* to align the nearest axis of the tool transformation (or offset) to the Z axis.



#### Additional Information

- The *Align* feature is only available for six-axis robots, like the Viper robots.
  - Other than the green Joint/Axis Control Buttons, *Jog To* and *Align* are the only functions available for moving the robot.
-

## 3-11 I/O Signals

Press the F3 Button to select I/O on Home 1 screen to display the screens used to control I/O signals. The I/O Signals feature allows users to toggle outputs ON (active, high) and OFF (inactive, low).

Round icons represent input signals and square icons represent output signals. The available signal types are: digital output, digital input, soft, and robot. The image below is an example of how digital inputs are displayed on the T20 Pendant.

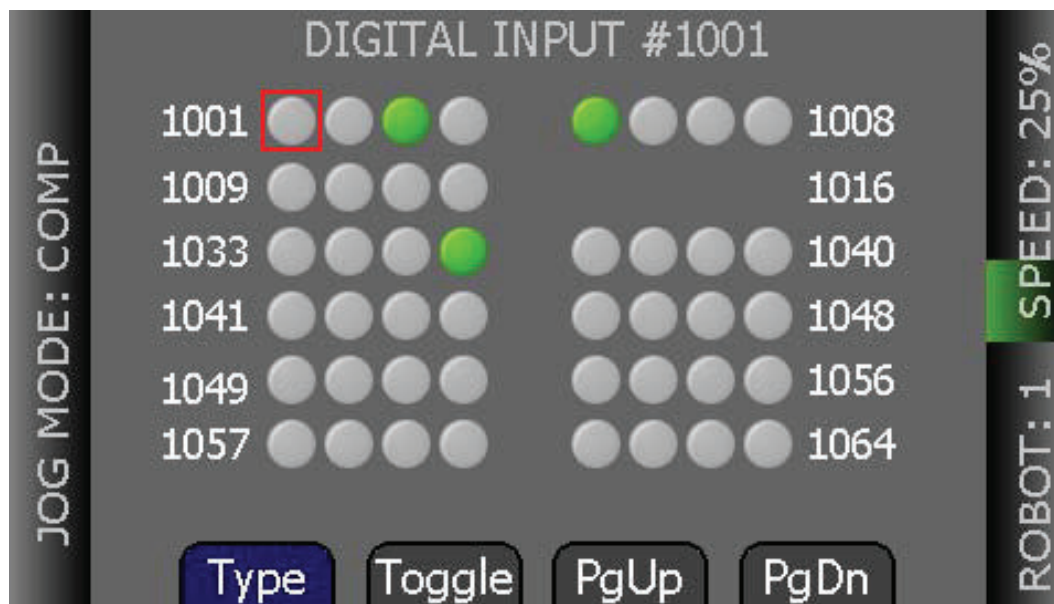

### Additional Information

The T20 Pendant does not support I/O access over EtherCAT.

### 3-11-1 Controlling the I/O Signals

After selecting I/O, perform the following steps to control I/O signals.

- 1** Press the F1 Button to select *Type* to cycle through the available signal types until the desired signal type is displayed. The current signal type and the selected signal number are displayed at the top of the screen.
- 2** Press the arrow buttons to select the desired signal. The selected signal is identified by a red outline.  
If more than one row of signals is available, press the up/down arrow buttons to scroll through the rows of signals. If more than one screen full of signals is displayed, select F3 or F4 for the *PgUp* or *PgDn* to scroll through the screens.
- 3** For output signals, press the F2 Button to select *Toggle* to turn the selected signal ON or OFF.

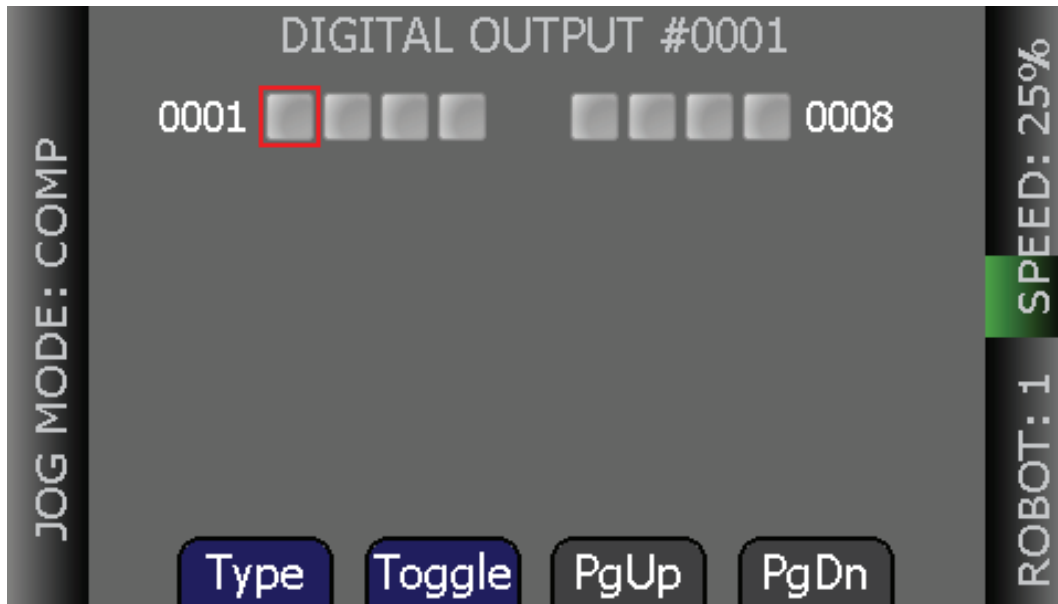
**Additional Information**

As there is only one screen available for digital outputs, the *PgUp* and *PgDn* soft keys are not available on the *Digital Output* screen.

## 3-12 Displaying and Clearing Errors

When errors occur, the ERR LED lights and a screen describing the error is displayed. Press the OK Button or Cancel Button to clear the error information.

While the error screen is displayed, the Menu button, arrow buttons, and soft keys are disabled. Even though the soft keys remain blue, they are not active in this state.

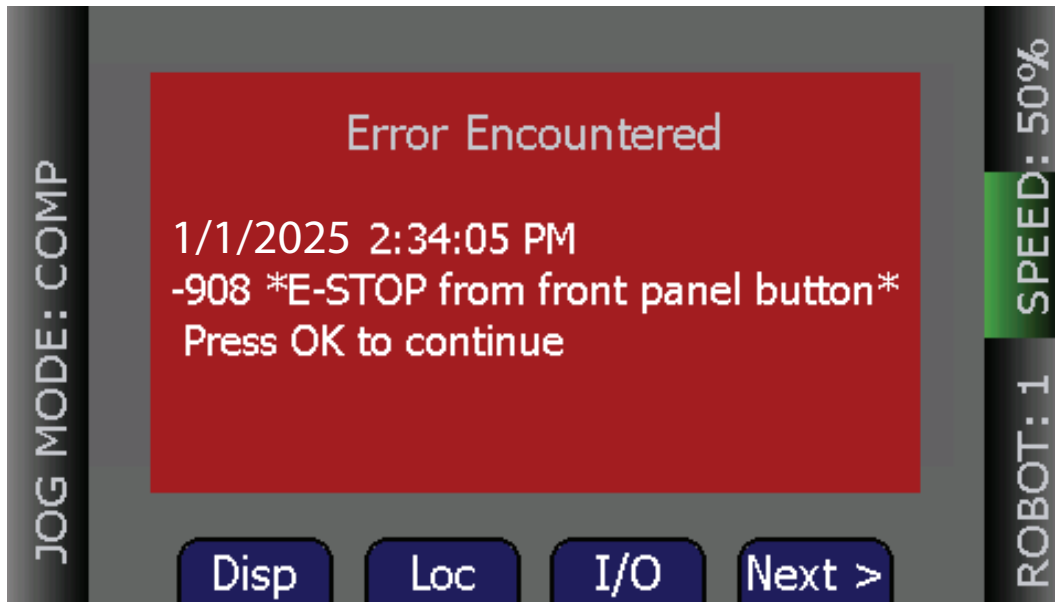

In order for these errors to be displayed, the *Pendant Msgs* must be enabled, from the *System Maintenance* screen.

## 3-13 System Maintenance Screen

The *System Maintenance* Screen is used to set various pendant options, obtain information on the system, and view the error log.

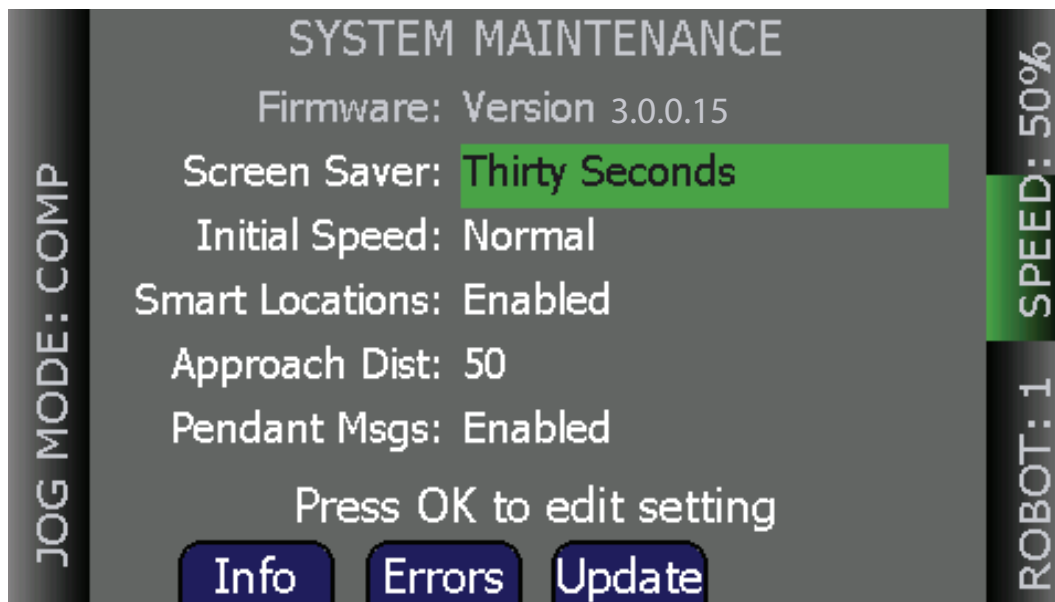

The following table describes the options shown on the *System Maintenance* Screen.

Option	Description
<i>Screen Saver</i>	Sets the screen-idle time ( <i>Thirty Seconds, One Minute, Two Minutes, Five Minutes, Ten Minutes, Twenty Minutes, One Hour</i> ) before the screen saver is activated.
<i>Initial Speed</i>	Sets the default speed used when the system starts up ( <i>Slow, Normal</i> ).
<i>Smart Locations</i>	Enables/disables the <i>Smart Locations</i> feature, which organizes the locations by type.
<i>Approach Dist</i>	Sets the approach distance (1 mm to 200 mm).
<i>Pendant Msgs</i>	Enables/disables whether errors are displayed. If disabled, errors are not reported to the pendant.

The following table describes the soft keys shown on the *System Maintenance* Screen.

Soft Key	Description
<i>Info</i>	Accesses a screen that displays the system information from the controller.
<i>Errors</i>	Accesses the error log.
<i>Update</i>	Updates the pendant firmware.

## 3-14 Screen Saver Settings

---

You can specify the length of time without activity before the screen saver is activated. Use the following procedure to set the *Screen Saver* idle time.

- 1** From the Home 1 screen, press the F4 Button twice to select *Next >* twice to display the Home 3 screen.
- 2** Press the F1 Button to select *Maint.* to open the *System Maintenance* Screen.
- 3** If necessary, press the up/down arrow buttons to select the *Screen Saver* field. Press the OK Button.
- 4** Press the up/down arrow buttons to select the length of time before the screen saver is activated.  
The options available are:
  - *Thirty Seconds*
  - *One Minutes*
  - *Two Minutes*
  - *Five Minutes*
  - *Ten Minutes*
  - *Twenty Minutes*
  - *One Hour*
- 5** Press the OK Button to accept the change.

## 3-15 Enabling Smart Locations

---

The Smart Locations feature allows you to view Tool, Frame, and General locations on separate pages.

Use the following procedure to enable the *Smart Locations* option.

- 1** From the Home 1 screen, press the F4 Button twice to select *Next >* twice to display the Home 3 screen.
- 2** Press the F1 Button to select *Maint.* to open the *System Maintenance* Screen.
- 3** Press the up/down arrow buttons to select the *Smart Locations* option. Press the OK Button.
- 4** Press the up/down arrow buttons to select *Enabled* or *Disabled*.
- 5** Press the OK Button to accept the change.



## 3-16 Setting Approach Distance

---

The Approach Distance feature is used to specify the distance from which the robot will approach the selected location.

Use the following procedure to select the Approach Distance.

- 1** From the Home 1 screen, press the F4 Button twice to select *Next >* twice to display the Home 3 screen.
- 2** Press the F1 Button to select *Maint.* to open the *System Maintenance* Screen.
- 3** Press the up/down arrow buttons to select the *Approach* field. Press OK.
- 4** Press the up/down arrow buttons to select a value from *1 mm* to *200 mm*.
- 5** Press the OK Button to accept the change.

## 3-17 Enabling Pendant Message

---

You can disable all error messages except the *Connection Lost* Screen, which is displayed if the T20 Pendant ever loses connection to the SmartController EX motion controller.

Use the following procedure to enable the display of error messages on the pendant.

- 1** From the Home 1 screen, press the F4 Button twice to select *Next* > twice to display the Home 3 screen.
- 2** Press the press the F1 Button to select *Maint.* to open the *System Maintenance* Screen.
- 3** Press the up/down arrow buttons to select the *Pendant Msgs* option. Press the OK Button.
- 4** Press the up/down arrow buttons to select *Enabled* or *Disabled*.
- 5** Press the OK Button to accept the change.

## 3-18 System Information Screen

The *System Information* screen displays identity information about components of the system, as returned by the *ID* and *NET* monitor commands.

The screen displays the IP address of the connected controller. The controller type and OP/SV switch position have the following effect on the IP address displayed.

Controller Type	OP/SV Switch Position	IP Address Displayed
SmartController EX	N/A	SmartController EX
eAIB or eMB		eAIB or eMB
iCS-ENET		iCS-ENET
iCS-ECAT or eCS-ECAT	OP	NJ-series Robot Integrated CPU unit
	SV	iCS-ECAT or eCS-ECAT

### 3-18-1 Displaying System Information

Use the following procedure to access the *System Information* Screen.

- 1** From the Home 1 screen, press the F4 Button twice to select *Next* > twice to display the Home 3 screen.
- 2** Press the F1 Button to select *Maint.* to open the *System Maintenance* Screen.
- 3** From the *System Maintenance* Screen, press the F1 Button to select *Info*. The following screen opens.

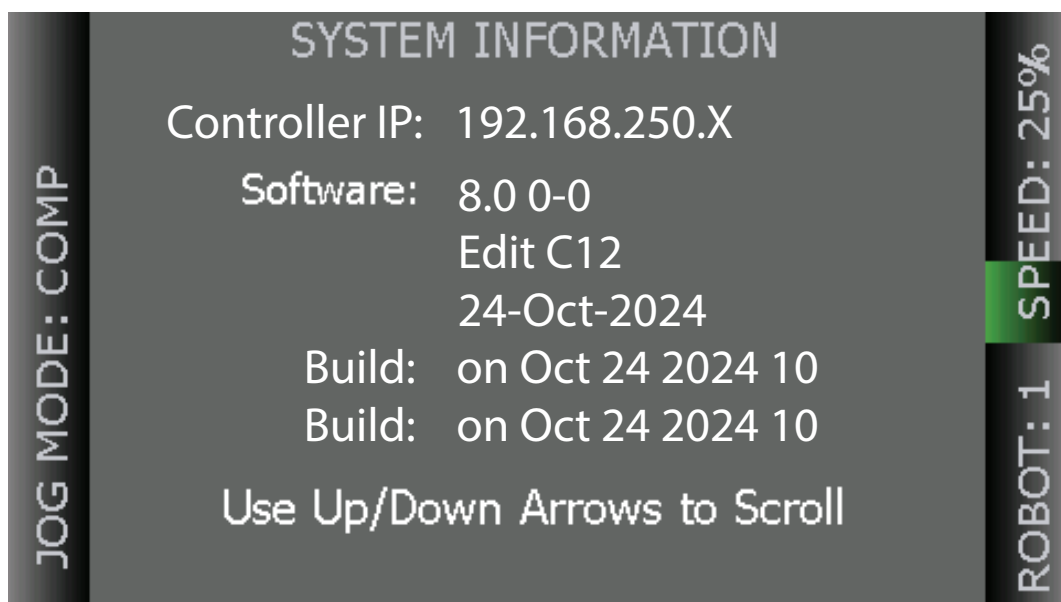

## 3-19 Displaying Recent Errors

You can display a list of errors that have occurred since the pendant was last powered up. Use the following procedure to display recent errors.

- 1** From the Home 1 screen, press the F4 Button twice to select *Next* > twice to display the Home 3 screen.
- 2** Press the F1 Button to select *Maint.* to open the *System Maintenance* Screen.
- 3** Press the F2 Button to select *Errors*. The *Recent Errors* Screen opens.
- 4** If necessary, press the up/down arrow buttons to select the error of interest.
- 5** Press the F1 Button to select *Detail* to display details about the selected error.

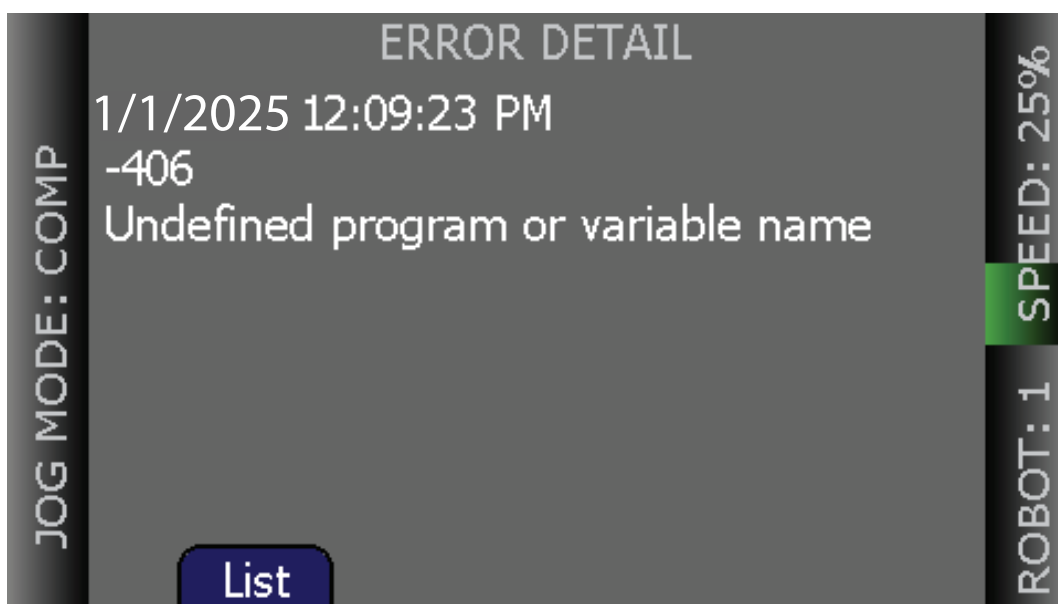
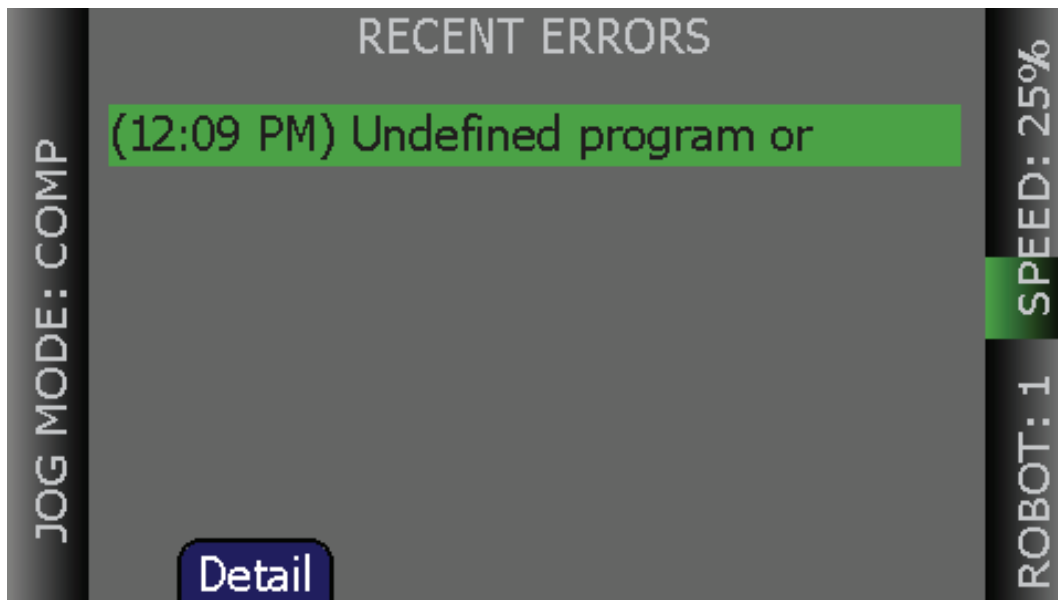

- 6 Press the F1 Button to select *List* to return to the *Recent Errors* Screen.

## 3-20 Updating the Pendant Firmware

Use the following procedure to update the Pendant firmware.

- 1** Turn OFF power to the SmartController EX motion controller or disconnect the T20 Pendant from the controller (see 3-1 *Connecting the T20 Pendant* on page 3-3).
- 2** Insert a Micro SD card containing the firmware update files and "*T20UpdatePackage.dat*" into the pendant. Make sure the files are located under the following path and folder name: "*T20Update*".

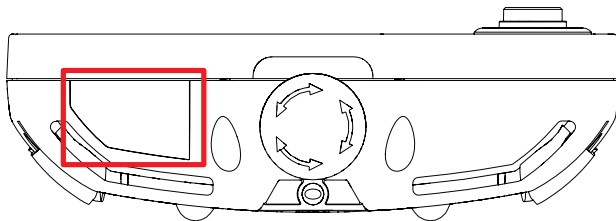

- 3** Reapply power to the controller, or reconnect the T20 Pendant to the controller, depending on how you removed power.
- 4** After a reboot, on the Home 1 screen, press the F4 Button twice to select *Next* > twice to display the Home 2 screen.
- 5** Press the F1 Button to select *Maint.* to open the *System Maintenance* Screen.
- 6** Press the F3 Button to select *Update*.
- 7** Press the OK Button. A screen displaying status messages about the update will be displayed. The messages should indicate that the system was able to detect the firmware update and that the firmware update was successfully verified.
- 8** Press the OK Button. The firmware will be copied to the pendant.
- 9** After the update has completed, the pendant reboots automatically.  
If you encounter any problems while updating the firmware, check the following:
  - Make sure the Micro SD card is fully inserted in the pendant and that you reboot the pendant after inserting the Micro SD card.
  - Make sure the firmware update files are stored in a folder named "*T20Update*" on the Micro SD card.
  - The update package performs a checksum test to verify the integrity of the contents of the update files. If any of the files are corrupted, the update package will fail to verify the contents. If this error occurs, obtain new update files from your local OMRON representative.



### Additional Information

In the event a firmware update fails, you can operate the pendant using the factory-installed firmware, which is always present on the pendant.

## 3-21 Loss of Communication

If the T20 Pendant ever loses communication with the connected controller for any reason (e.g. controller reboot), a *Communication Lost* screen will be displayed. From this screen, pressing the OK Button will tell the pendant to try to reestablish communication with the controller.



If the reconnection fails, use the ACE or Sysmac Studio software to verify that the controller's monitor window is responsive. If this state persists, contact your local OMRON representative for assistance.



### Additional Information

If the pendant ever loses contact with the controller, the pendant will display the *Communication Lost* screen. From this screen, you will be prompted to reconnect with the controller. This message is not affected by the *Pendant Msgs* setting.

You can display a list of errors that have occurred since the pendant was last powered up. For details, see 3-19 *Displaying Recent Errors* on page 3-36.







# Maintenance

This section provides information on the maintenance of the T-20 Pendant.

---

4-1	Maintenance Actions .....	4-2
-----	---------------------------	-----

## 4-1 Maintenance Actions

---

Periodically check the protective covers of the T20 Pendant to ensure that all housing screws are firmly tightened, and that there is no damage to the cable entry area, sealing plug, or cable strain-relief. To clean the T20 Pendant, use a soft cloth dampened with a small amount of water or a mild cleaning agent.

### CAUTION

Never clean the T20 Pendant display screen or other surfaces with solvents, abrasive cleaners, or scrubbing sponges.





## **OMRON Corporation Industrial Automation Company**

**Kyoto, JAPAN**

**Contact : [www.ia.omron.com](http://www.ia.omron.com)**

### **Regional Headquarters**

#### **OMRON EUROPE B.V.**

Wegalaan 67-69, 2132 JD Hoofddorp  
The Netherlands  
Tel: (31) 2356-81-300 Fax: (31) 2356-81-388

#### **OMRON ASIA PACIFIC PTE. LTD.**

438B Alexandra Road, #08-01/02 Alexandra  
Technopark, Singapore 119968  
Tel: (65) 6835-3011 Fax: (65) 6835-3011

#### **OMRON ELECTRONICS LLC**

2895 Greenspoint Parkway, Suite 200  
Hoffman Estates, IL 60169 U.S.A.  
Tel: (1) 847-843-7900 Fax: (1) 847-843-7787

#### **OMRON ROBOTICS AND SAFETY TECHNOLOGIES, INC.**

4225 Hacienda Drive, Pleasanton, CA 94588 U.S.A.  
Tel: (1) 925-245-3400 Fax: (1) 925-960-0590

#### **OMRON (CHINA) CO., LTD.**

Room 2211, Bank of China Tower, 200 Yin Cheng Zhong Road,  
PuDong New Area, Shanghai, 200120, China  
Tel: (86) 21-6023-0333 Fax: (86) 21-5037-2388

**Authorized Distributor:**

©OMRON Corporation 2023 All Rights Reserved.  
In the interest of product improvement,  
specifications are subject to change without notice.

**Cat. No. I601-E-05** 0325

10433-000