

The
SOLUTIONS

**[Safety Door Switches,
Safety Limit Switches]**

Must-read Before using a switch

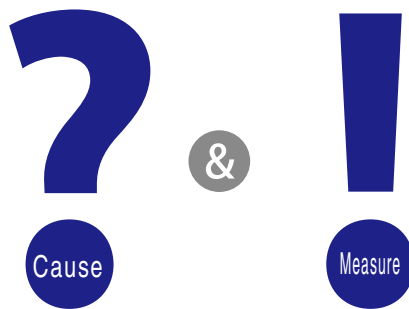

Let's Prolong Switch Life by Preventing Failures!

Introduction

We would like to thank you for using our switches.

We started to develop switches over half a century ago. In order to do everything possible to meet the needs of our customers, we have been committed to various types of switch development and quality improvement. We summarized preventive measures against failures in this guide so that customers will use our switches more safely.

We would appreciate if "The Solution" would be useful in preventive/corrective actions when a malfunction occurs.

We will continue to meet our customers' needs by focusing on core technologies, and appreciate your continued business.

OMRON Corporation

Notes

- This manual is aimed at safety door switches (excluding non-contact door switches) and safety limit switches.
- "The Solution" introduces some typical examples of failures found by our customers.
- Please understand some cases may not apply to "The Solution".
- For precautions to be taken in cases other than those specified in "The Solution", please refer to the precautions specified in the data sheet of each product (be sure to use correctly), and the "Precautions Common to Safety Door Switches" and "Precautions Common to Safety Limit Switches".
- If you wish to check the switch by yourself before requesting our analysis, please check only the appearance and operation, and return the switch to us without disassembling it (such as opening the cover).
- Please note that if you disassemble a switch (such as opening the cover), we may not be able to investigate the true cause.

Table of Contents

D4SL-N	
■The mechanism of failure occurrence	A-1
If the release key is in the UNLOCK state...	A-3
If the voltage applied to the solenoid is insufficient...	A-4
If the set stroke of the operation key is inappropriate...	A-5
If voltage is applied to the solenoid before inserting the operation key... (Only solenoid lock models)	A-7
If the door is tried to be forcibly opened while it is locked...	A-8
If an abnormal voltage is applied between the power supply terminals...	A-10
If a large quantity of foreign material flows into the head...	A-11

D4NL	
■The mechanism of failure occurrence	B-1
If the release key is in the UNLOCK state...	B-3
If the voltage applied to the solenoid is insufficient...	B-4
If the set stroke of the operation key is inappropriate...	B-5
If the head is attached while the release key is in the LOCK state... (Only mechanical lock models)	B-7
If the door is tried to be forcibly opened while it is locked...	B-9
If fluid enters inside the switch...	B-11

D4JL	
■The mechanism of failure occurrence	C-1
If the release key is in the UNLOCK state...	C-3
If the voltage applied to the solenoid is insufficient...	C-5
If the set stroke of the operation key is inappropriate...	C-6

D4BL	
■The mechanism of failure occurrence	D-1
If the voltage applied to the solenoid is insufficient...	D-3
If the set stroke of the operation key is inappropriate...	D-4

D4BS•D4GS-N•D4NS	
■The mechanism of failure occurrence	E-1
D4BS If the set stroke of the operation key is inappropriate...	E-3
D4GS-N If the set stroke of the operation key is inappropriate...	E-4
D4NS If the set stroke of the operation key is inappropriate...	E-6
D4NS If the cover securing screws are tightened without the cover...	E-8

Common for Safety Limit Switches	
■The mechanism of failure occurrence	F-1
If the operating/return stroke is insufficient...	F-3
If fluid enters inside the switch...	F-5

Common for Safety Door Switches / Safety Limit Switches	
■The mechanism of failure occurrence	G-1
If a silicon gas is present in the vicinity...	G-3

D4SL-N

D4NL

D4JL

D4BL

D4BS•D4GS-N•D4NS

Common for Safety Limit Switches

Common for Safety Door Switches / Safety Limit Switches

D4SL-N

The mechanism of failure occurrence

Cause/reason	Possible failure when using the switch
<p>The release key remains in the UNLOCK state</p>	<p><Operating failure> The operation key comes off without being locked. <Contact failure> Mechanical lock models ...The contact of the lock monitor switch does not switch even after inserting the operation key. Solenoid lock models ...The contact of the lock monitor switch does not switch even after inserting the operation key and operating the solenoid.</p>
<p>Insufficient voltage application to the solenoid</p>	<p><Operating failure> Mechanical lock models ...The lock cannot be released. Solenoid lock models ...The lock cannot be applied. <Contact failure> The contact of the lock monitor switch does not switch.</p>
<p>Inappropriate set stroke of the operation key</p>	<p><If the stroke is insufficient> • The lock cannot be applied or released even if the solenoid is operated. • The contact of the door open/close detection and lock monitor switch does not switch. <If the stroke is excessive> • The head collides with the collars of the operation key.</p>
<p>Voltage application to the solenoid before insertion of the operation key (Solenoid lock models)</p>	<p><Operating failure> The operation key comes off without being locked. <Contact failure> The contact of the lock monitor switch does not switch.</p>
<p>If the door is tried to be forcibly opened while it is locked</p>	<p><Operating failure> • The operation key comes off without being locked. • The operation key cannot be inserted again. • The operation key does not come off even after unlocking.</p>
<p>If an abnormal voltage is applied between the power supply terminals</p>	<p><Operating failure> • The solenoid does not operate, and the lock cannot be applied or released. • The LED does not light up. • The solenoid is malfunctioning.</p>
<p>Flow of large quantity of foreign material into the head</p>	<p><Operating failure> The operation key cannot be inserted.</p>



Direct causes leading to failures	Checkpoint for prevention (measures)
<ul style="list-style-type: none"> The release key remains in the UNLOCK state The release key stops halfway through 	<p>Before using the product, make sure the release key is in the LOCK state. (The mechanical lock models are shipped with the release key in the UNLOCK state.)</p>
<p>Insufficient voltage application to the solenoid</p>	<p>Make sure that rated operating voltage is applied to the solenoid. Rated operating voltage: 24 VDC +10%/-15% (20.4 to 26.4 V)</p>
<p>Deviation of the operation key from the set zone</p>	<p>Make sure the distance from the end part of the head till the end part of the operation key is within a range of 0.5 to 3 mm (appropriate set zone).</p>
<p>Voltage application before insertion of the operation key</p>	<p>For solenoid lock models, be sure to supply power to the solenoid after the door is closed (after the operation key is inserted in the switch).</p>
<p>Damage of internal parts (cam)</p>	<ul style="list-style-type: none"> Do not forcibly open the door while it is locked. Even when the door is closed with force, a pull-out force may be applied on the operation key in the locked state because of rebound. (Mechanical lock models)
<p>The electronic parts are damaged, and the solenoid either does not operate or starts malfunctioning</p>	<ul style="list-style-type: none"> Do not use a DC power supply that tends to generate noise (simple half-wave rectified or full-wave rectified DC power supply). If there is a power line (motor or inverter) parallel to or in contact with the switch wiring, which tends to generate noise, be sure to separate the switch wiring from the power line.
<p>Position deviation of internal parts (cam)</p>	<p>Use the switches at a location where cut shavings, oil, water, or chemicals do not come in contact with the operation key insertion slot of the head portion.</p>

[If the release key is in the UNLOCK state...]

■ What are the possible failures?



<Operating failure>

The operation key comes off without being locked.

<Contact failure>

Mechanical lock models ... The contact of the lock monitor switch does not switch even after inserting the operation key.

Solenoid lock models ... The contact of the lock monitor switch does not switch even after inserting the operation key and operating the solenoid.

■ The failure case

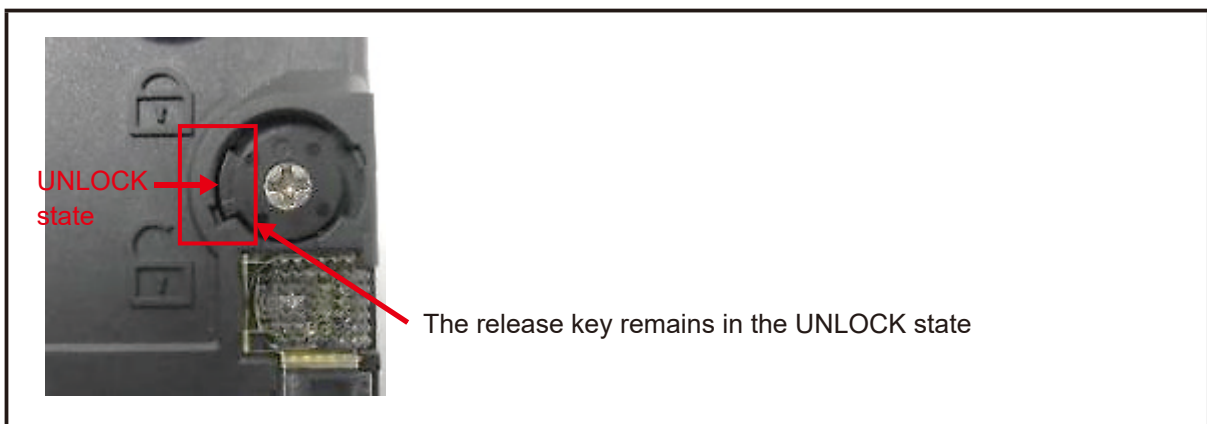

■ Checkpoint for prevention!



Check if the release key is in the UNLOCK state.

The mechanical lock models are shipped with the release key in the UNLOCK state.

Before using the product, switch the release key to the LOCK state.

Fully turn the release key so that it does not stop halfway through in both the LOCK and UNLOCK state.

- When a Switch with a solenoid lock is in a locked state (i.e., when the solenoid is ON), do not change the release key from the LOCK to the UNLOCK position. Internal parts may be damaged.
- After setting the release key to UNLOCK to, for example, perform maintenance, be sure to return it to LOCK setting before resuming operation.
- The release key is set in the unlock position at the factory for the D4SL-N□□□A and to the lock position for the D4SL-N□□□G.
- In the unlock position, even when the door of large machines or stamping machines is closed during preliminary adjustment, the door will remain unlocked and the machines will not be activated.

[LOCK state]

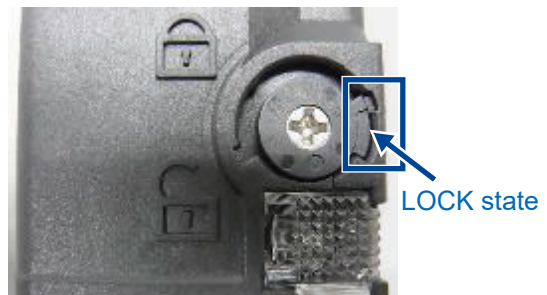

[If the voltage applied to the solenoid is insufficient...]

■ What are the possible failures?



<Operating failure>
 Mechanical lock models ... The lock cannot be released.
 Solenoid lock models..... The lock cannot be applied.
 <Contact failure>
 The contact of the lock monitor switch does not switch.

■ Checkpoint for prevention!



Check if the voltage applied to the solenoid has fallen below the rated operating voltage.

If rated voltage is not applied to the solenoid due to an abnormality in the load or wiring, the solenoid may not operate.

Rated operating voltage: 24 VDC +10%/-15% (20.4 to 26.4 V)

Solenoid Coil Characteristics

Item	24 VDC
Rated operating voltage (100% ED)	24 VDC ^{+10%} / _{-15%}
Current consumption*	Power ON: 6-contact type Approx. 6.4 W at 0.26 A 4-contact/5-contact type Approx. 4.8 W at 0.2 A Constant: Approx. 2.6 W (average) at 0.2 A (max.)
Insulation	Class E (120°C max.)

* A starting current is applied to the solenoid for Approx. 10 seconds.
 After this, the internal circuit switches to a constant current.

[If the set stroke of the operation key is inappropriate...]

■ What are the possible failures?



<If the stroke is insufficient (The failure case →)>

- The lock cannot be applied or released even if the solenoid is operated.
- The contact of the door open/close detection and lock monitor switch does not switch.

<If the stroke is excessive (The failure case ←)>

- The head collides with the collars of the operation key.

■ The failure case

- The set zone range (0.5 to 3 mm) is exceeded.

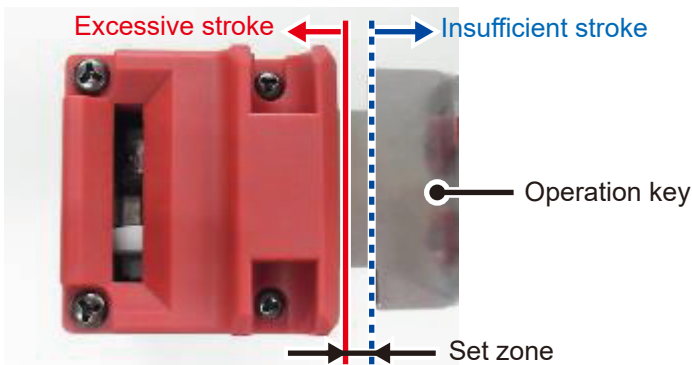

■ Checkpoint for prevention!



(1) Check if the operation key stroke is insufficient.

If the operation key stroke is insufficient, the lock cannot be applied or released. Also, the output may not be correct.

The appropriate set zone range for the switch is a distance of 0.5 to 3 mm from the end part of the head till the end part of the operation key. (See the □ part)

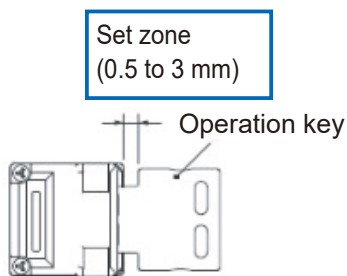

* If you use the D4SL-NK5 with the front key hole oriented in the direction shown in the right diagram, the set zone will be 2.1 to 3.0 mm.

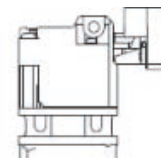

■ Securing the Door

When the door is closed (with the Operation Key inserted), the Operation Key may exceed the set zone because of, for example, the door's own weight, machine vibration, or the door cushion rubber.

Secure the door with a stopper (hook) so that the Operation Key remains within the set zone.



(2) Check if the head collides with the collars of the operation key.

Do not use a Switch as a stopper.

Be sure to install a stopper as shown in the following illustration so that the Operation Key does not touch the head.

Do not subject the Switch to a shock that exceeds the Switch's shock resistance of $1,000 \text{ m/s}^2$.

Collars of the operation key (○ part)

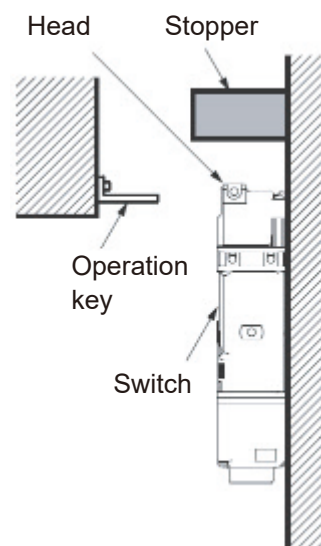
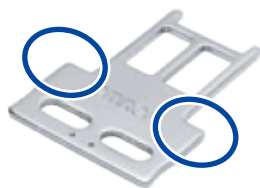

[If voltage is applied to the solenoid before inserting the operation key...]

(D4SL-N□□□G Solenoid lock models only)

■ What are the possible failures?



<Operating failure>

The operation key comes off without being locked.

<Contact failure>

The contact of the lock monitor switch does not switch.

■ Checkpoint for prevention!



Check if the operation key is inserted before voltage is applied to the solenoid, or while power is being supplied.

For solenoid lock models, be sure to supply power to the solenoid after the door is closed (after the operation key is inserted). If the door is closed after power is supplied to the solenoid, locking the operation key may not be possible.

* The solenoid carry current is applied for Approx. 10 seconds, after which the internal circuit switches to a constant current. The lock may not operate properly while the constant current is applied.

[If the door is tried to be forcibly opened while it is locked.]

■ What are the possible failures?



<Operating failure>

- The operation key comes off without being locked.
- The operation key cannot be inserted again.
- The operation key does not come off even after unlocking.

■ The failure case

Stress is applied to the metallic cam and the metallic cam breaks.

The lock cannot be applied, and operating failures such as obstruction to the cam rotation by the fragments of the broken cam may occur.

Inside the head

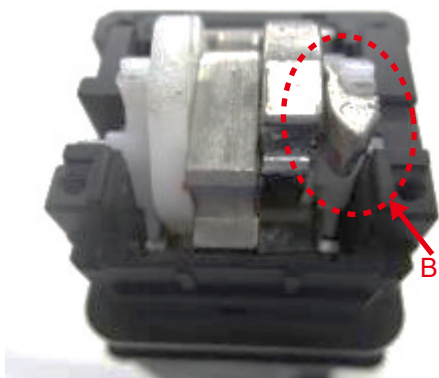

Metallic cam



Breakage

Operation key comes off

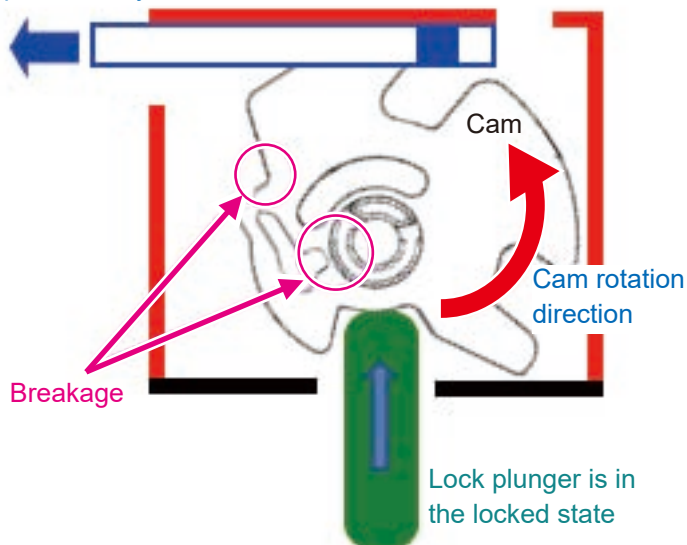

When the operation key has been completely inserted (locked state), the cam rotates in the direction of the arrow when an attempt is made to pull out the operation key in the direction of opening the door, because of which stress is applied to the ○ parts of the cam, resulting in breakage.

■ Checkpoint for prevention!



Check if the door is tried to be forcibly opened while it is locked.

If a pull-out force is applied to the operation key in the locked state, the cam may break.

Do not forcibly open the door while it is locked.

Even when the door is closed with force, a pull-out force may be applied on the operation key in the locked state because of rebound. (Mechanical lock models)

◆ Securing the Door

If the closed door (with the Operation Key inserted) pulls the Operation Key past the operating/lock position (i.e., the set zone (□ part)) because of, for example, the door's own weight, machine vibration, or the door cushion rubber, the Switch may be damaged.

As a measure against rebounding, secure the door with a fastener (hook) or something similar.

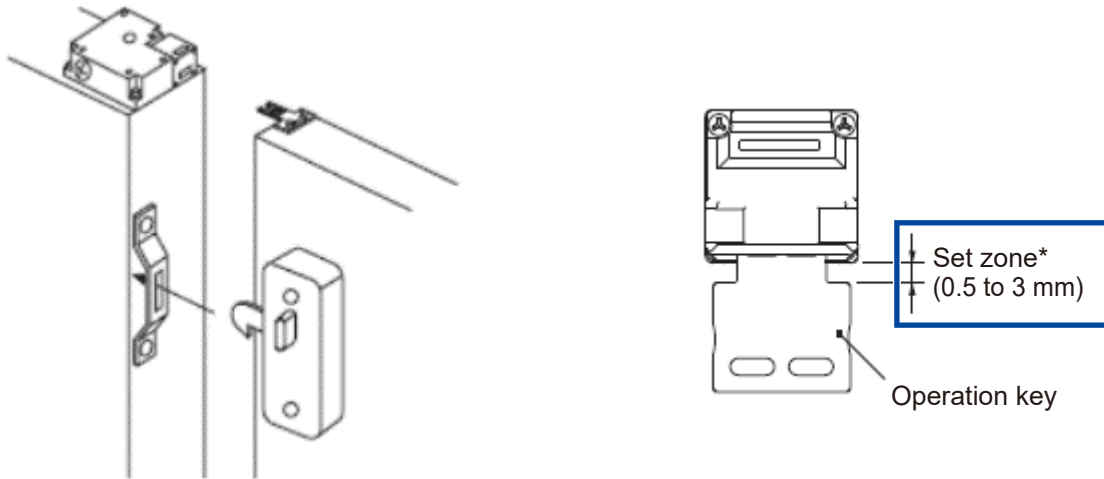

* The switch shown in the figure above is for the D4NL, but the manner of fixing is the same.

[If an abnormal voltage is applied between the power supply terminals...]

■ What are the possible failures?



<Operating failure>

- The solenoid does not operate, and the lock cannot be applied or released.
- The LED does not light up.
- The solenoid is malfunctioning.
- and more.

■ The failure case

If excess current flows through the power supply terminals E1 (+) and E2 (-), or abnormal voltages such as noise and surge are applied, the electronic parts are damaged, and the solenoid either does not operate or starts malfunctioning.

Example of transistor damage

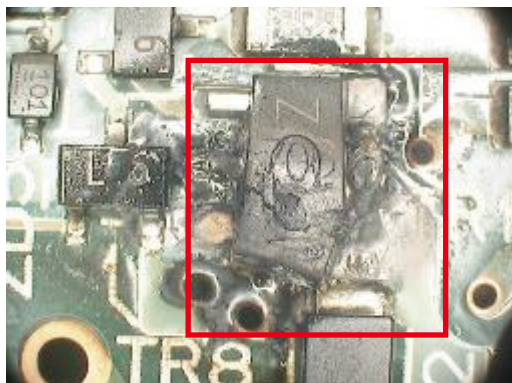

Example of fuse damage

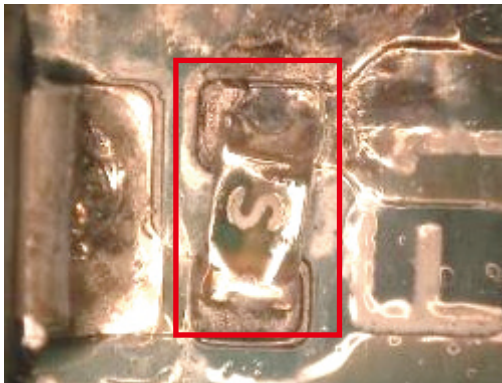

■ Checkpoint for prevention!



(1) Check if DC power supply that tends to generate noise is in use.

If simple half-wave rectified or full-wave rectified DC power supply is in use, an operating failure or damage to the elements may occur as a result of noise and ripples.



(2) Check if there is a power line parallel to or in contact with the switch wiring.

If there is a power line (motor or inverter) parallel to or in contact with the switch wiring, noise may be induced through the capacitance of the wire coating.

Be sure to separate the switch wiring from the power line.

[If a large quantity of foreign material flows into the head...]

■ What are the possible failures?



<Operating failure>
The operation key cannot be inserted.

■ The failure case

As a result of inflow of foreign material into the head, the cam may not be able to rotate properly, resulting in position deviation.

As a result of position deviation, it may not be possible to insert the operation key.

<Inside the head>

* **Parts A** ... Operation key insertion parts in cams

Normal state inside the head

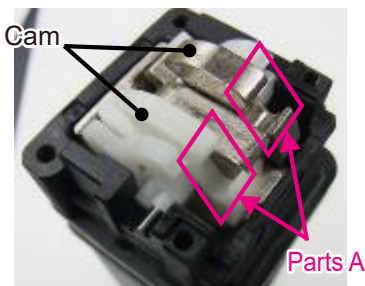

Parts A are in normal position

Normal state inside the head



The position of **parts A** is deviating



A large quantity of foreign material has flown in

■ Checkpoint for prevention!



Check if the switch is being used in a dusty environment or where cuttings may be scattered.

Although the switch box is protected from dust, oil or water penetration, do not use the D4SL in places where cutting chips, oil, water or chemicals may enter through the key hole on the head, otherwise Switch damage or malfunctioning may occur.

This could result in position deviation of the internal parts (cam), early wear-out, damage, or failure.



Operation key
insertion slot

m e m o

A series of horizontal dashed lines for writing a memo.

D4NL

The mechanism of failure occurrence

Cause/reason

The release key remains in the UNLOCK state

Insufficient voltage application to the solenoid

Inappropriate set stroke of the operation key

Attachment of head in the release key LOCK state
(Mechanical lock models)

If the door is tried to be forcibly opened while it is locked

Inflow of fluid into the switch

Possible failure when using the switch

<Operating failure>
The operation key comes off without being locked.
<Contact failure>
Mechanical lock models
...The contact of the lock monitor switch does not switch even after inserting the operation key.
Solenoid lock models
...The contact of the lock monitor switch does not switch even after inserting the operation key and operating the solenoid.

<Operating failure>
Mechanical lock models
...The lock cannot be released.
Solenoid lock models
...The lock cannot be applied.
<Contact failure>
The contact of the lock monitor switch does not switch.

<If the stroke is insufficient>
• The lock cannot be applied or released even if the solenoid is operated.
• The contact of the door open/close detection and lock monitor switch does not switch.
<If the stroke is excessive>
• The head collides with the collars of the operation key.

<Operating failure>
Regardless of whether the release key is in the LOCK or UNLOCK state, the operation key comes off, or the operation key cannot be pulled out or inserted.
<Contact failure>
The contact either does not turn ON or does not switch even when the operation key is inserted.

<Operating failure>
Regardless of whether the release key is in the LOCK or UNLOCK state, the operation key comes off, or the operation key cannot be pulled out or inserted again.
<Contact failure>
The contact either does not turn ON or does not switch even when the operation key is inserted.

<Operating failure>
• The solenoid does not operate even when voltage is applied.
• The operation key cannot be inserted.
<Contact failure>
• The contact does not turn ON or is unstable.
• The contact is constantly powered on

D4NL



Direct causes leading to failures

- The release key remains in the UNLOCK state
- The release key stops halfway through

Insufficient voltage application to the solenoid

Deviation of the operation key from the set zone

Damage of internal parts (lock plate)

Damage of internal parts (lock plate)

- Solenoid burnout or short-circuiting
- Corrosion of contact
- Cam position deviation due to grease solidification

Checkpoint for prevention (measures)

Before using the product, make sure the release key is in the LOCK state.
(The mechanical lock models are shipped with the release key in the UNLOCK state.)

Make sure that rated operating voltage is applied to the solenoid.
[24 VDC model]
Rated operating voltage: 24 VDC +10%/-15% (20.4 to 26.4 V)
[110 VAC model]
Rated operating voltage: 110 VAC±10% (99 to 121 V)

Make sure the distance from the end part of the head till the end part of the operation key is within a range of 0.5 to 3 mm (appropriate set zone).

The head removal → installation work must be performed either after changing the release key to the "UNLOCK state" or while the operation key is inserted in the head.

- Do not forcibly open the door while it is locked.
- Even when the door is closed with force, a pull-out force may be applied on the operation key in the locked state because of rebound. (Mechanical lock models)

- Do not use the switch in oil or water, or in an environment where the switch is constantly exposed to water or oil.
- Tighten each screw to an appropriate tightening torque.

[If the release key is in the UNLOCK state...]

■ What are the possible failures?



<Operating failure>

The operation key comes off without being locked.

<Contact failure>

Mechanical lock models ... The contact of the lock monitor switch does not switch even after inserting the operation key.

Solenoid lock models ... The contact of the lock monitor switch does not switch even after inserting the operation key and operating the solenoid.

■ The failure case

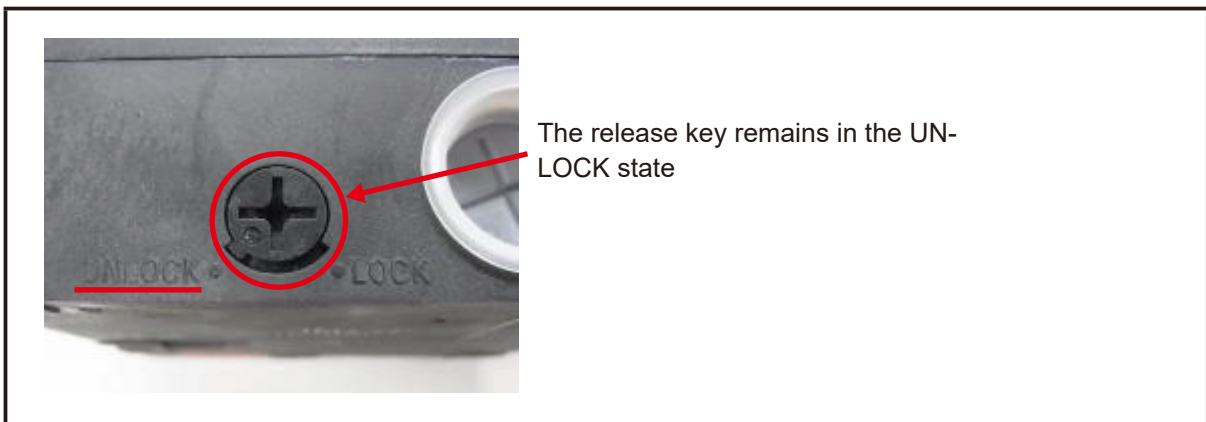

■ Checkpoint for prevention!



Check if the release key is in the UNLOCK state.

The mechanical lock models are shipped with the release key in the UNLOCK state.

Before using the product, switch the release key to the LOCK state.

Fully turn the release key so that it does not stop halfway through in both the LOCK and UNLOCK state.

- When a Switch with a solenoid lock is in a locked state (i.e., when the solenoid is ON), do not change the release key from the LOCK to the UNLOCK position. Internal parts may be damaged.
- The release key is set in the unlock position at the factory for the D4NL-□□□A/B/C and to the lock position for the D4NL-□□□G/H/J.

[LOCK state]



[If the voltage applied to the solenoid is insufficient...]

■ What are the possible failures?



<Operating failure>

Mechanical lock models ... The lock cannot be released.

Solenoid lock models ... The lock cannot be applied.

<Contact failure>

The contact of the lock monitor switch does not switch.

■ Checkpoint for prevention!



Check if the voltage applied to the solenoid has fallen below the rated operating voltage.

If rated voltage is not applied to the solenoid due to an abnormality in the load or wiring, the solenoid may not operate.

[24 VDC model]

Rated operating voltage: 24 VDC +10%/-15% (20.4 to 26.4 V)

[110 VAC model]

Rated operating voltage: 110 VAC±10% (99 to 121 V)

Solenoid Coil Characteristics

Item	Type	24 VDC	110 VAC
Rated operating voltage (100% ED)		24 VDC ^{+10%} / _{-15%}	110 VAC±10%
Current consumption		Approx. 200 mA	Approx. 50mA
Insulation		Class B (130°C max.)	

[If the set stroke of the operation key is inappropriate...]

■ What are the possible failures?



<If the stroke is insufficient (The failure case ↑)>

- The lock cannot be applied or released even if the solenoid is operated.
- The contact of the door open/close detection and lock monitor switch does not switch.

<If the stroke is excessive (The failure case ↓)>

- The head collides with the collars of the operation key.

■ The failure case

- The set zone range (0.5 to 3 mm) is exceeded.

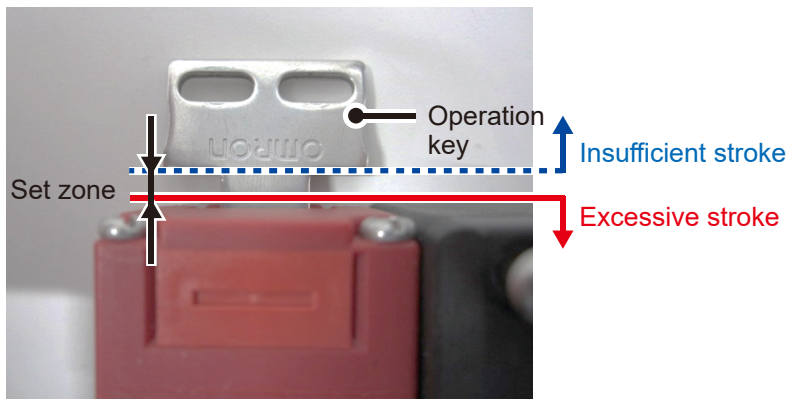

■ Checkpoint for prevention!



(1) Check if the operation key stroke is insufficient.

If the operation key stroke is insufficient, the lock cannot be applied or released. Also, the output may not be correct.

The appropriate set zone range for the switch is a distance of 0.5 to 3 mm from the end part of the head till the end part of the operation key. (See the □ part)



(2) Check if the main unit (head) is used as a stopper.

Be sure to install a stopper as shown in the following illustration to ensure that the base of the Operation Key does not strike the Head, and adjust the stopper to be within the setting zone of the base of the Operation Key.

Collars of the operation key (○ part)

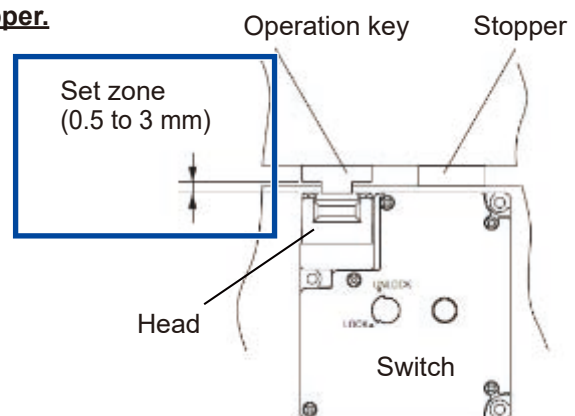
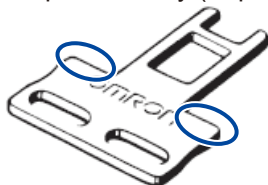

■ Securing the Door

To ensure that the door stops within the set zone, secure the door with a fastener (hook) or something similar.

When the door is closed (with the Operation Key inserted), the Operation Key may exceed the set zone because of, for example, the door's own weight, machine vibration, or the door cushion rubber.

Also, it may not be possible to pull out the Operation Key if there is weight placed on the Operation Key. Secure the door with a stopper so that the Switch is not included as the locking member of the door.

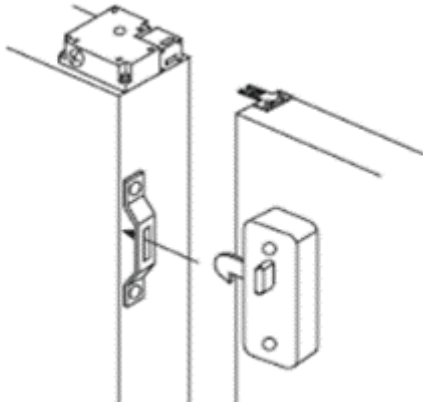

* The switch shown in the figure above is for the D4NL, but the manner of fixing is the same.

[If the head is attached while the release key is in the LOCK state...]

(D4NL-□□□□A, -□□□□B Mechanical lock models only)

■ What are the possible failures?



<Operating failure>

- Regardless of whether the release key is in the LOCK or UNLOCK state, the operation key comes off.
- Else, the operation key cannot be pulled out or inserted.

<Contact failure>

- The contact either does not turn ON or does not switch even when the operation key is inserted.

■ The failure case

- If the head is attached to the main unit while the release key is in the LOCK state and the operation key has not been inserted, the internal parts may be damaged.



When the operation key is not inserted in the head

The attachment screws are tightened and the head is forcibly assembled.

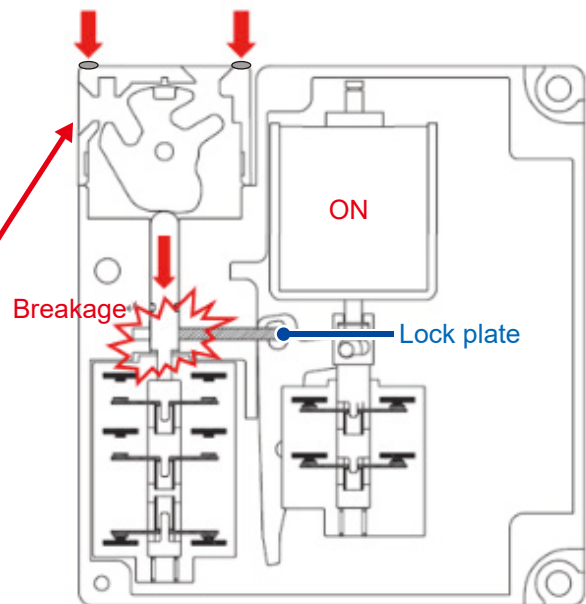

NG switch

OK switch

If the fragments of the lock plate obstruct the sliding of the internal parts, it may not be possible to pull out the operation key.

* Depending on the intervening position of fragments, the operation key may or may not come off.



The lock plate is broken

■ **Checkpoint for prevention!**



Check if the release key is in the LOCK state. (Mechanical lock models)

The head removal → installation work must be performed either after changing the release key to the "UNLOCK state" or while the operation key is inserted in the head.

* The lock plate is used to control the motion of the plunger, and by controlling the plunger, the cam inside the head can no longer rotate and is set to the locked state.

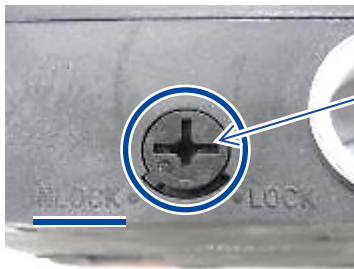

Release key UNLOCK state

[If the door is tried to be forcibly opened while it is locked.]

■ What are the possible failures?



<Operating failure>

- Regardless of whether the release key is in the LOCK or UNLOCK state, the operation key comes off.
- Else, the operation key cannot be pulled out or inserted again.

<Contact failure>

- The contact either does not turn ON or does not switch even when the operation key is inserted.

■ The failure case

- If the door is forcibly opened in the locked state, the internal parts are damaged.

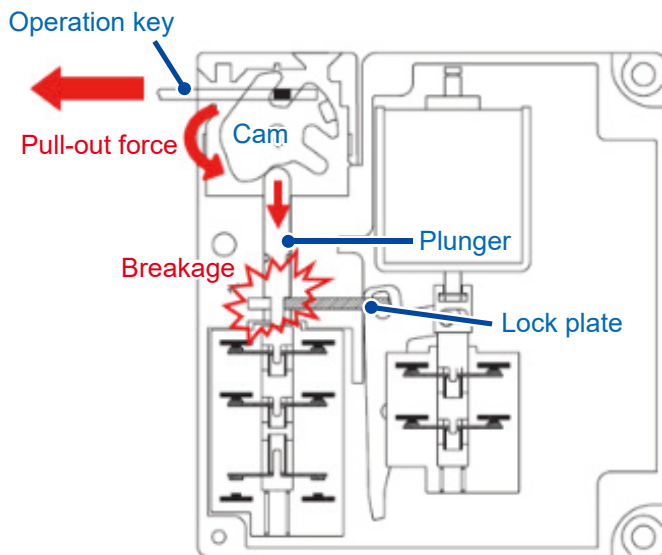

NG switch

OK switch

If the fragments of the lock plate obstruct the sliding of the internal parts, it may not be possible to pull out the operation key.

* Depending on the intervening position of fragments, the operation key may or may not come off.



The lock plate is broken

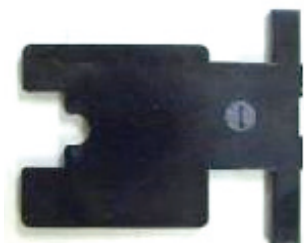

■ **Checkpoint for prevention!**



Check if the door is tried to be forcibly opened while it is locked.

If a pull-out force is applied to the operation key in the locked state, the lock plate is forcibly pushed in by the plunger, resulting in breakage of the lock plate.

Do not forcibly open the door while it is locked.

Even when the door is closed with force, a pull-out force may be applied on the operation key in the locked state because of rebound. (Mechanical lock models)

◆ **Securing the Door**

When the door is closed (with the Operation Key inserted), the Operation Key may exceed the set zone because of, for example, the door's own weight, machine vibration, or the door cushion rubber.

Also, it may not be possible to pull out the Operation Key if there is weight placed on the Operation Key. Secure the door with a stopper so that the Switch is not included as the locking member of the door.

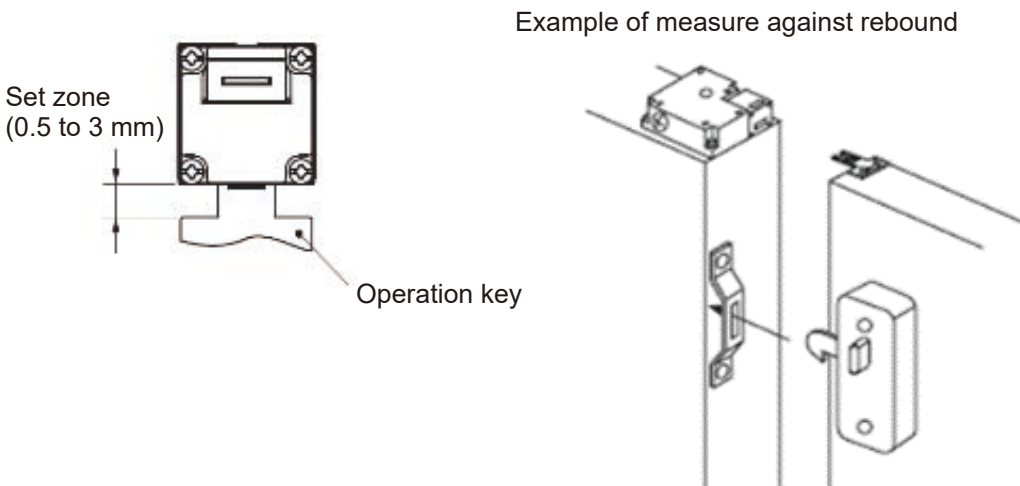

[If fluid enters inside the switch...]

■ What are the possible failures?



<Operating failure>

- The solenoid does not operate even when voltage is applied.
- The operation key cannot be inserted.

<Contact failure>

- The contact does not turn ON or is unstable.
- The contact is constantly powered on

■ The failure case

- If the switch is installed at a location where the cutting oil is scattered at all times

[Solenoid burnout]

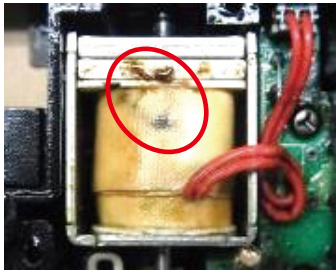

* Discoloration and burnout of the coil inside the coating

[Corrosion of contact]



* Green rust appears and the contact is corroded

[Cam position deviation due to grease solidification]

Inside the head

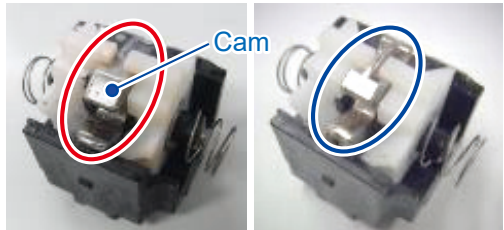

NG switch

OK switch (for comparison)

* NG switch... The sliding property of the cam declines because of the solidified grease, and the position of the cam deviates

■ Checkpoint for prevention!



(1) Check if fluid is constantly deposited on the switch.

Do not use the switch in oil or water, or in an environment where the switch is constantly exposed to water or oil as the water or oil may enter inside the switch.

Alternatively, examine measures of preventing the entry of fluid by changing the switch installation location or installing a protective cover.

The switches have a protective structure IP67 (drip-proof switches) and are not completely waterproof.

Although the switch box is protected from dust or water penetration, do not use the D4NL in places where foreign material may enter through the key hole on the head, otherwise Switch damage or malfunctioning may occur.



(2) Check if the screw is loose at any part.

The looseness in screws causes moisture or oil to enter inside the switch, resulting in corrosion or short-circuiting. Therefore, tighten each part to the appropriate tightening torque.

Type	Appropriate tightening torque
Terminal screw	0.59 to 0.78 N•m
Cover mounting screw	0.49 to 0.69 N•m
Head mounting screw	0.49 to 0.59 N•m
Operation key mounting screw	2.35 to 2.75 N•m
Switch mounting screw	0.49 to 0.69 N•m
Cable gland	1.77 to 2.16 N•m
Cap screw	1.27 to 1.67 N•m

D4JL

The mechanism of failure occurrence

D4JL

Cause/reason	Possible failure when using the switch
The release key remains in the UNLOCK state	<p><Operating failure> The operation key comes off without being locked.</p> <p><Contact failure> Mechanical lock models ...The contact of the lock monitor switch does not switch even after inserting the operation key. Solenoid lock models ...The contact of the lock monitor switch does not switch even after inserting the operation key and operating the solenoid.</p>
Insufficient voltage application to the solenoid	<p><Operating failure> Mechanical lock models ...The lock cannot be released. Solenoid lock models ...The lock cannot be applied.</p> <p><Contact failure> The contact of the lock monitor switch does not switch.</p>
Inappropriate set stroke of the operation key	<p><If the stroke is insufficient></p> <ul style="list-style-type: none">• The lock cannot be applied or released even if the solenoid is operated.• The contact of the door open/close detection and lock monitor switch does not switch. <p><If the stroke is excessive></p> <ul style="list-style-type: none">• The head collides with the collars of the operation key.

D4JL



Direct causes leading to failures

- The release key remains in the UNLOCK state
- The release key stops halfway through

Checkpoint for prevention (measures)

Before using the product, make sure the release key is in the LOCK state.
(The mechanical lock models are shipped with the release key in the UNLOCK state.)

Insufficient voltage application to the solenoid

Make sure that rated operating voltage is applied to the solenoid.
Rated operating voltage: 24 VDC +10%/-15% (20.4 to 26.4 V)

Deviation of the operation key from the set zone

Set the operation key to 0.8 (installation support tool) to 3.3 mm.

[If the release key is in the UNLOCK state...]

■ What are the possible failures?



<Operating failure>

The operation key comes off without being locked.

<Contact failure>

Mechanical lock models ... The contact of the lock monitor switch does not switch even after inserting the operation key.

Solenoid lock models ... The contact of the lock monitor switch does not switch even after inserting the operation key and operating the solenoid.

■ The failure case

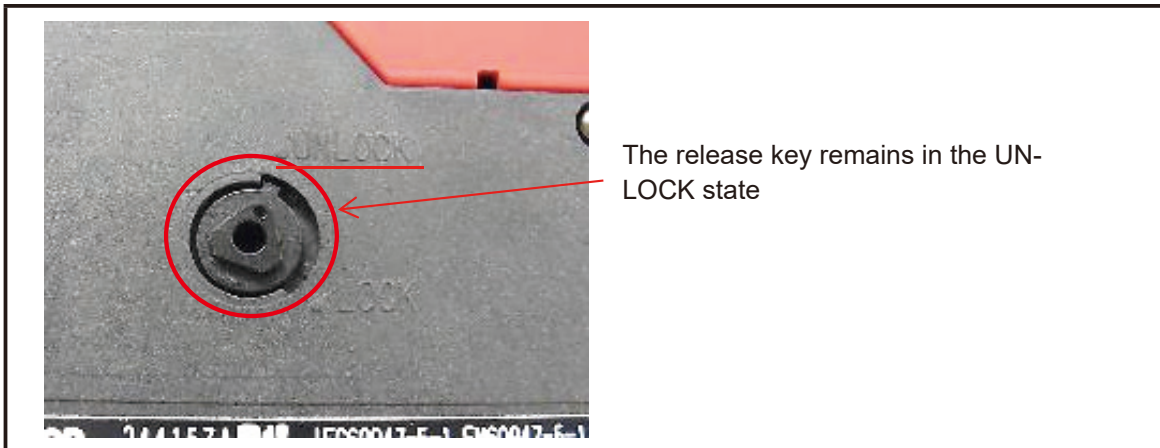

■ Checkpoint for prevention!



(1) Check if the release key is in the UNLOCK state.

The mechanical lock models are shipped with the release key in the UNLOCK state.

Before using the product, switch the release key to the LOCK state.

Fully turn the release key so that it does not stop halfway through in both the LOCK and UNLOCK state.

- When a Switch with a solenoid lock is in a locked state (i.e., when the solenoid is ON), do not change the release key from the LOCK to the UNLOCK position. Internal parts may be damaged.
- After setting the release key to UNLOCK to, for example, change the head direction or perform maintenance, be sure to return it to the LOCK setting before resuming operation.
- The release key is set in the unlock position at the factory for the D4JL-□□□A-□5, D4JL-□□□A-□6, D4JL-□□□A-□7-□□ and D4JL-□□□A-□8-01-SJ and in the lock position for the D4JL-□□□G-□5.
- If the release key is set to UNLOCK when the Switch is used for the door of a machine room to ensure the safety of people performing adjustment work inside, the door will not be locked when the door is closed and no power will be supplied to the equipment.
- Do not use the release key to start or stop machines.

[LOCK state]



(2) Check if the rear release button is in a pushed-in state or a halfway position.

The switches are shipped with the rear release button in the "Unlocked" state (pushed-in position).

Pull out the button before using the switch.

If the button is left pressed in, the door will not lock when the door is closed and power will not be supplied to the equipment.

If the return of the rear release button is insufficient, it could result in malfunctioning.

<Rear release button>

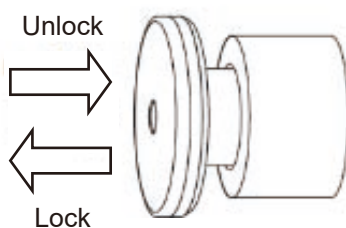

Pushed-in state: "Unlock"
Restored (return) state: "Lock"

[If the voltage applied to the solenoid is insufficient...]

■ What are the possible failures?



<Operating failure>
Mechanical lock models ... The lock cannot be released.
Solenoid lock models ... The lock cannot be applied.
<Contact failure>
The contact of the lock monitor switch does not switch.

■ Checkpoint for prevention!



Check if the voltage applied to the solenoid has fallen below the rated operating voltage.

If rated voltage is not applied to the solenoid due to an abnormality in the load or wiring, the solenoid may not operate.

Rated operating voltage: 24 VDC +10%/-15% (20.4 to 26.4 V)

Solenoid Coil Characteristics

Item	Type	24 VDC
Rated operating voltage (100% ED)		24 VDC ^{+10%} _{-15%}
Current consumption		Approx. 200 mA
Insulation class		Class B (130°C max.)

[If the set stroke of the operation key is inappropriate...]

■ What are the possible failures?



<If the stroke is insufficient (The failure case ↓)>

- The lock cannot be applied or released even if the solenoid is operated.
- The contact of the door open/close detection and lock monitor switch does not switch.

<If the stroke is excessive (The failure case ↑)>

- The head collides with the collars of the operation key.

■ The failure case

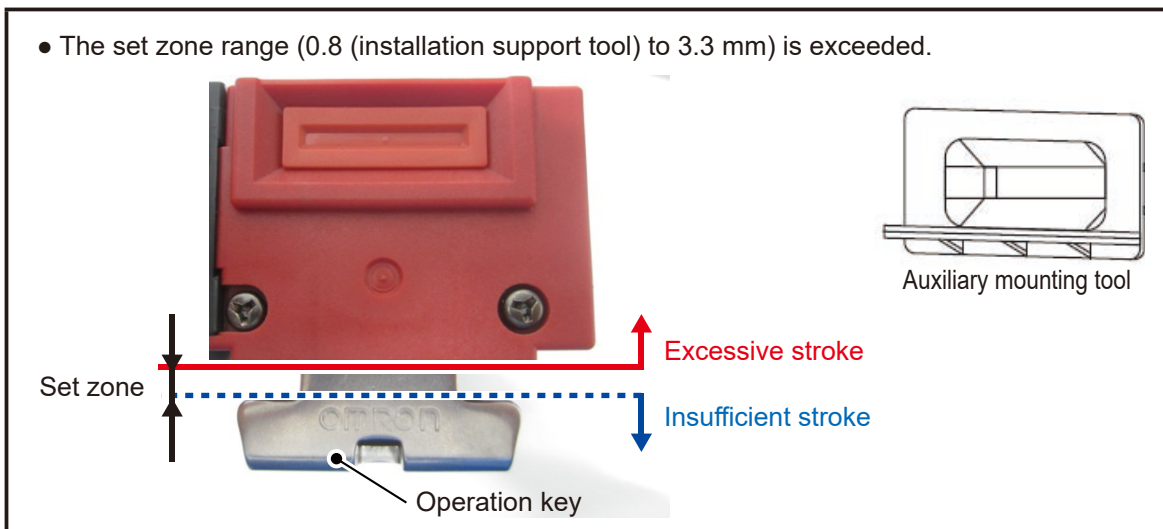

■ Checkpoint for prevention!



(1) Check if the operation key is set at the correct position.

If the operation key deviates from the set zone, the lock cannot be applied or released.

Also, the stroke may become insufficient and the output may not be correct.

The appropriate set zone for the switch is a distance of 3.3 mm from the installation support tool. (See the □ part)

Ensure that the alignment offset between the Operation Key and the key hole does not exceed ± 0.8 mm. If the Operation Key is offset or at an angle, accelerated wear or damage to the Switch may result.

Collars of the operation key (○ part)

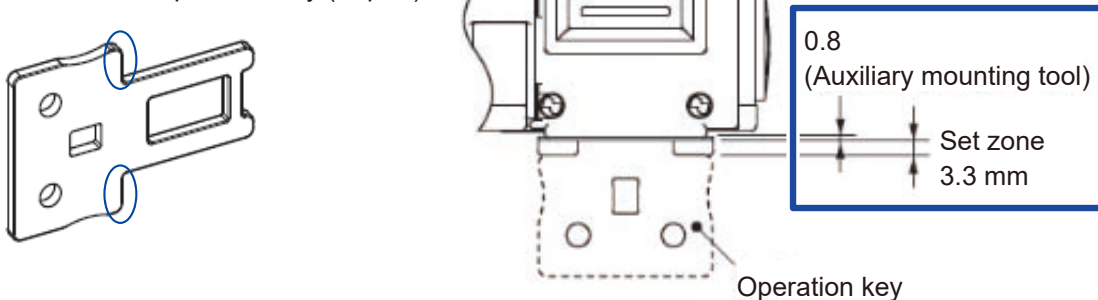

■ Securing Doors

When the door is closed (with the Operation Key inserted), the Operation Key may exceed the set zone because of, for example, the door's own weight, machine vibration, or the door cushion rubber.

Then, when an attempt is made to open the door, it may result in damage or malfunction. Also, it may not be possible to unlock the Switch if there is weight placed on the Operation Key. Do not rely on the Switch to substitute for a door locking device. Secure the door with a stopper so that the Operation Key remains within the set zone.

■ Installing the stopper

Do not use the Switch as a stopper. Be sure to install a stopper as shown in the following illustration when mounting the Switch and adjust the stopper so that the Operation Key is within the setting zone.

Do not subject the Switch(head) to a shock that exceeds the Switch's shock resistance of $1,000 \text{ m/s}^2$.

Correct)

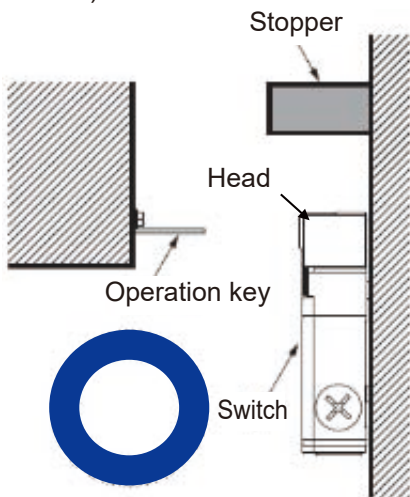

Incorrect)

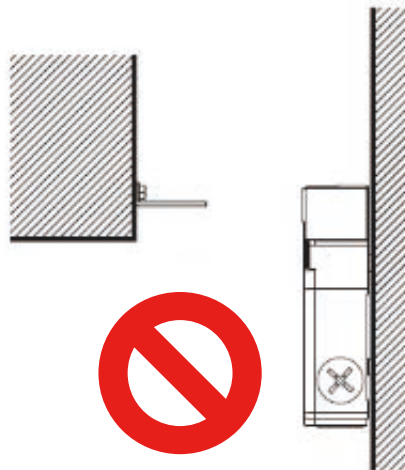

m e m o

D4BL

The mechanism of failure occurrence

Cause/reason	Possible failure when using the switch
Insufficient voltage application to the solenoid	<p><Operating failure> Mechanical lock models ...The lock cannot be released. Solenoid lock models ...The lock cannot be applied.</p> <p><Contact failure> The contact between 12 and 31, and between 22 and 41 (*1) does not switch. (*1) For D4BL-2GRD-AT</p>
Inappropriate set stroke of the operation key	<p><If the stroke is insufficient></p> <ul style="list-style-type: none">• The lock cannot be applied or released even if the solenoid is operated.• The contact of the door open/close detection and lock monitor switch does not switch. <p><If the stroke is excessive></p> <ul style="list-style-type: none">• The head collides with the collars of the operation key.

D4BL



Direct causes leading to failures

Insufficient voltage application to the solenoid

Deviation of the operation key from the set zone

Checkpoint for prevention (measures)

Make sure that rated operating voltage is applied to the solenoid.
Rated operating voltage: 24 VDC +10%/-15% (20.4 to 26.4 V)

Make sure the distance from the end part of the head till the end part of the operation key is within a range of 0.5 to 5 mm (appropriate set zone).

[If the voltage applied to the solenoid is insufficient...]

■ What are the possible failures?



<Operating failure>

Mechanical lock models ... The lock cannot be released.

Solenoid lock models ... The lock cannot be applied.

<Contact failure>

The contact between 12 and 31, and between 22 and 41 (*1) does not switch.

(*1) For D4BL-2GRD-AT

■ Checkpoint for prevention!



Check if the voltage applied to the solenoid has fallen below the rated operating voltage.

If rated voltage is not applied to the solenoid due to an abnormality in the load or wiring, the solenoid may not operate.

Rated operating voltage: 24 VDC +10%/-15% (20.4 to 26.4 V)

Solenoid coil characteristics

Item	Type	24 VDC mechanical lock models	24 VDC solenoid lock models
Rated operating voltage		24 VDC ^{+10%} / _{-15%} (100% ED)	
Current consumption		Approx. 300 mA	
Insulation class		Class B (130°C or less)	

[If the set stroke of the operation key is inappropriate...]

■ What are the possible failures?



<If the stroke is insufficient (The failure case ←)>

- The lock cannot be applied or released even if the solenoid is operated.
- The contact of the door open/close detection and lock monitor switch does not switch.

<If the stroke is excessive (The failure case →)>

- The head collides with the collars of the operation key.

■ The failure case

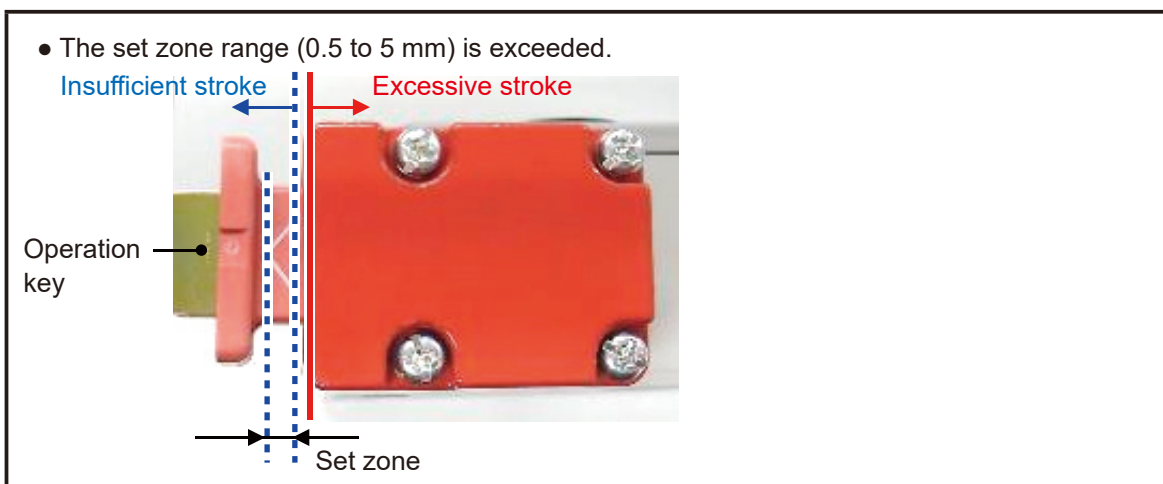

■ Checkpoint for prevention!



(1) Check if the operation key is set at the correct position.

If the operation key deviates from the set zone, the lock cannot be applied or released.

Also, the stroke may become insufficient and the output may not be correct.

The appropriate set zone range for the switch is a distance of 0.5 to 5 mm from the end part of the head till the end part of the operation key (within the range of the ◀ : mark). (See the □ part)

Correct)

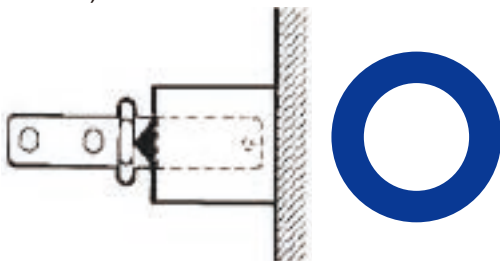

Incorrect)

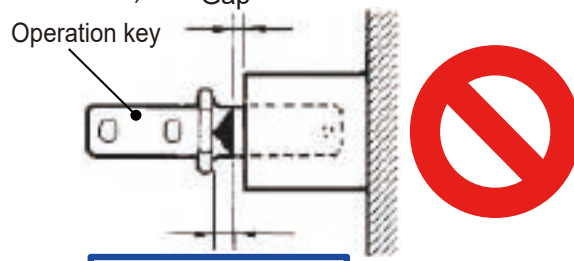

Set zone
(0.5 to 5 mm)



(2) Check if the force of the pull-out direction is applied to the operation key.

By applying the force of the pull-out direction on the operation key and forcibly closing the door, the rebound force is exerted and the operation key deviates from the set zone.

■ Stopper Installation

Do not use a Switch as a stopper. Be sure to install a stopper as shown in the following illustration when mounting the Switch so that the Operation Key is within 0.5 to 5 mm of the set zone.

Do not subject the Switch(head) to a shock that exceeds the Switch's shock resistance of 1,000 m/s².

Collars of the operation key (○ part)

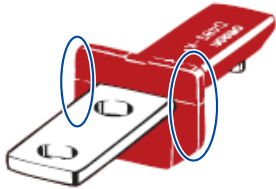

Correct)

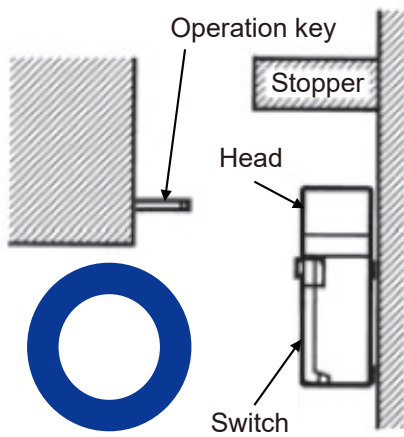

Incorrect)

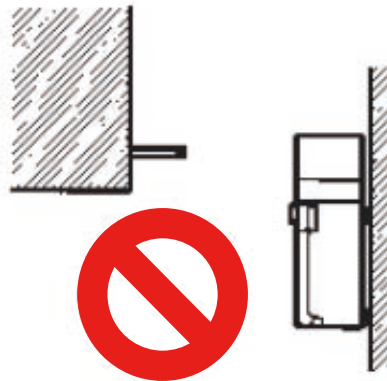

m e m o

A series of horizontal dashed lines for writing.



D4BS•D4GS-N•D4NS

The mechanism of failure occurrence

Cause/reason	Possible failure when using the switch
Common to all models Inappropriate set stroke of the operation key	D4BS <Contact failure> The output is not correct.
	D4GS-N <If the stroke is insufficient> • The output is not correct. <If the stroke is excessive> • The head collides with the collars of the operation key.
	D4NS <If the stroke is insufficient> • The output is not correct. <If the stroke is excessive> • The head collides with the collars of the operation key.
D4NS Tightening of cover securing screws without the cover	<Contact failure> • There is no power supply or the contact is constantly powered on • Regardless of whether the operation key is inserted or not inserted, conduction does not switch.

D4BS



D4GS-N



D4NS



Direct causes leading to failures

Deviation of the operation key from the set zone

Checkpoint for prevention (measures)

D4BS

Adjust the operation key within the appropriate set zone (triangular mark) range.

D4GS-N

Make sure the distance from the end part of the head till the end part of the operation key is within a range of 0.5 to 3 mm (appropriate set zone).

D4NS

Make sure the distance from the end part of the head till the end part of the operation key is within a range of 0.5 to 3 mm (appropriate set zone).

Obstruction to sliding of parts due to insertion of securing screws deep inside, by as much as the thickness of the cover

After the wiring work, be sure to close the cover and then tighten the securing screws.

D4BS

[If the set stroke of the operation key is inappropriate...]

■ What are the possible failures?



<Contact failure>
The output is not correct.

■ The failure case

- The set zone range (< part) is exceeded.

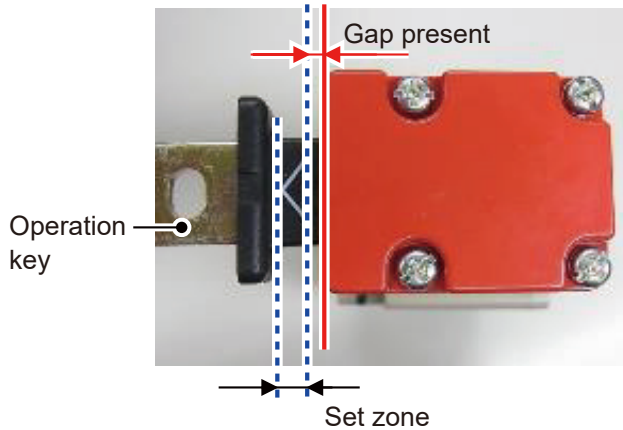

■ Checkpoint for prevention!



(1) Check if the operation key is set at the correct position.

If the operation key deviates from the set zone, the stroke may become insufficient and the output may not be correct.

Adjust the operation key of the switch within the appropriate set zone (triangular mark: ◀ range, as shown in the figure below. (See the □ part)

Correct)

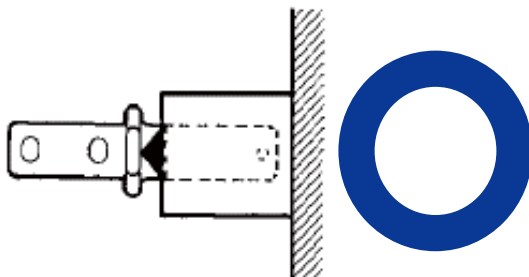

Incorrect)

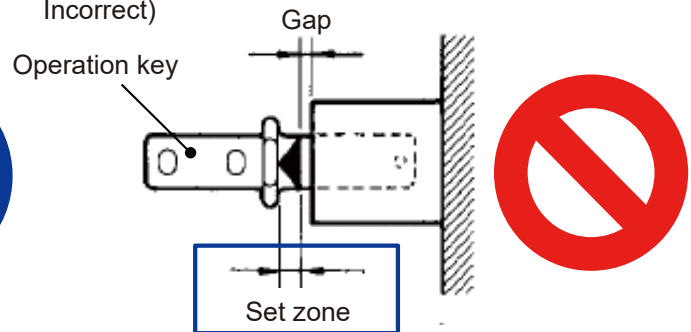

D4GS-N

[If the set stroke of the operation key is inappropriate...]

■ What are the possible failures?



<If the stroke is insufficient (The failure case ←)>

- The output is not correct.

<If the stroke is excessive (The failure case →)>

- The head collides with the collars of the operation key.

■ The failure case

- The set zone range (0.5 to 3 mm) is exceeded.

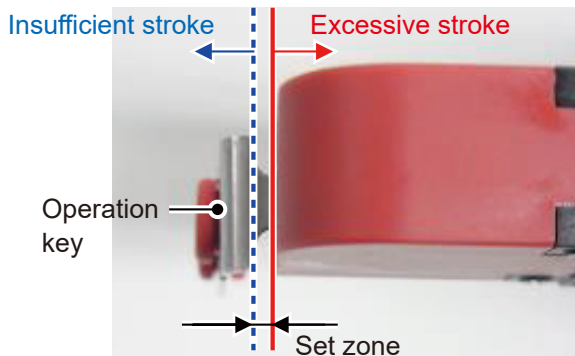

■ Checkpoint for prevention!



(1) Check if the operation key is set at the correct position.

If the operation key deviates from the set zone, the stroke may become insufficient and the output may not be correct.

The appropriate set zone range for the switch is a distance of 0.5 to 3 mm from the end part of the head till the end part of the operation key, as shown in the figure below. (See the □ part)

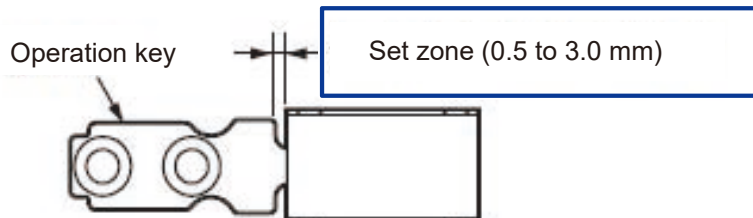



(2) Check if the head collides with the collars of the operation key.

Do not use a Switch as a stopper.

Be sure to install a stopper as shown in the following illustration when mounting the Switch and adjust the stopper so that the Operation Key is within the setting zone.

Do not subject the Switch(head) to a shock that exceeds the Switch's shock resistance of 1,000 m/s².

Collars of the operation key (○ part)

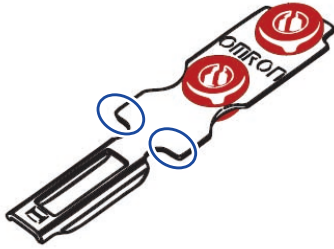

Correct)

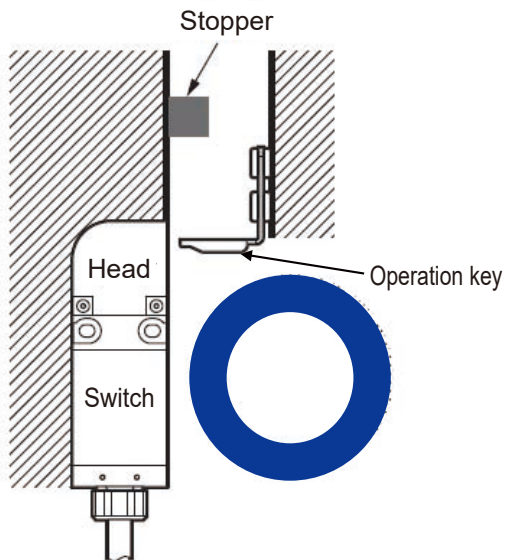

Incorrect)

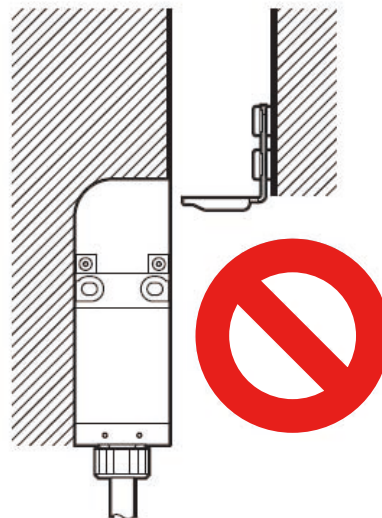

D4NS

[If the set stroke of the operation key is inappropriate...]

■ What are the possible failures?



<If the stroke is insufficient (The failure case →)>

- The output is not correct.

<If the stroke is excessive (The failure case ←)>

- The head collides with the collars of the operation key.

■ The failure case

- The set zone range (0.5 to 3 mm) is exceeded.

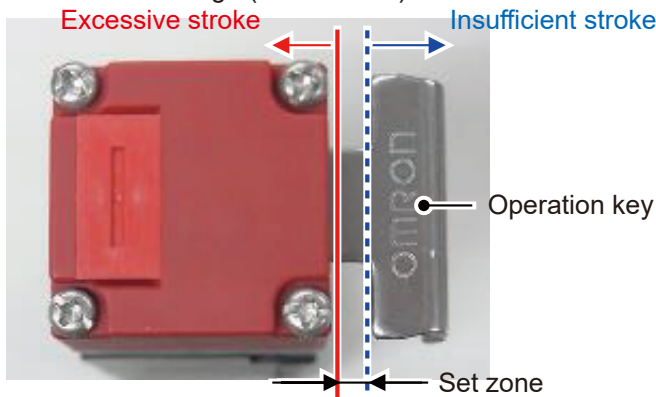

■ Checkpoint for prevention!



(1) Check if the operation key is set at the correct position.

If the operation key deviates from the set zone, the stroke may become insufficient and the output may not be correct.

The appropriate set zone range for the switch is a distance of 0.5 to 3 mm from the end part of the head till the end part of the operation key, as shown in the figure below. (See the □ part)

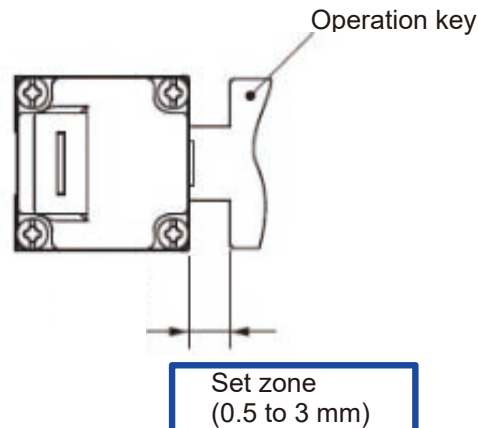



(2) Check if the head collides with the collars of the operation key.

Do not use a Switch as a stopper. Be sure to install a stopper as shown in the following illustration to ensure that the base of the Operation Key does not strike the Head, and adjust the stopper to be within the setting zone (0.5 to 3 mm) of the base of the Operation Key. Do not subject the Switch(head) to a shock that exceeds the Switch's shock resistance of 1,000 m/s².

Collars of the operation key (○ part)

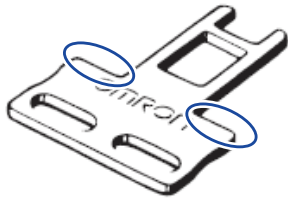

Correct)

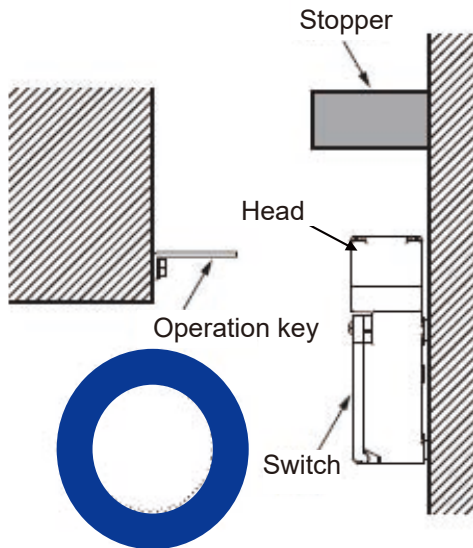

Incorrect)

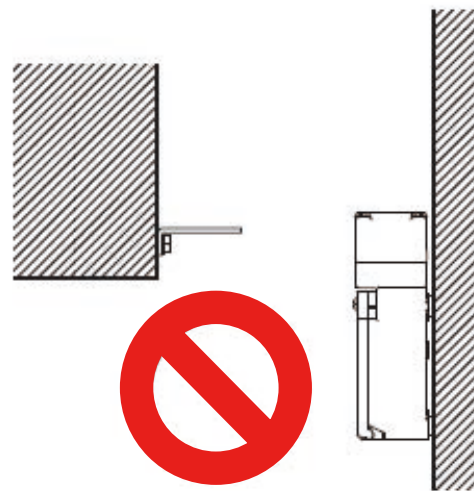

D4NS

[If the cover securing screws are tightened without the cover...]

■ What are the possible failures?



<Contact failure>

- There is no power supply or the contact is constantly powered on
- Regardless of whether the operation key is inserted or not inserted, conduction does not switch.

■ The failure case

- When the cover securing screws are tightened while the cover is open or is not installed

[As seen from the top (head removed)]

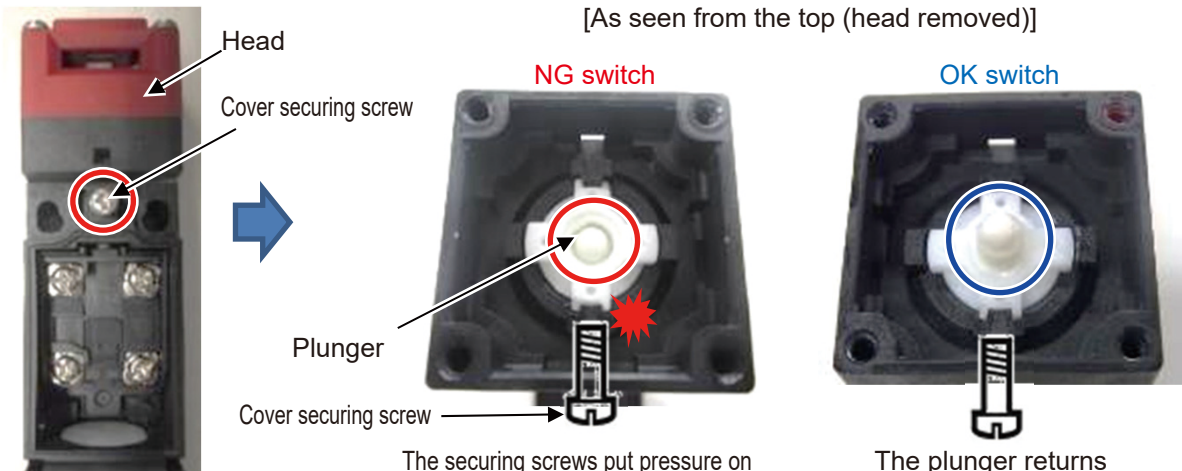

The securing screws put pressure on the plunger sliding surface because of which the plunger can no longer return

The plunger returns (Normal state)

[As seen from the side (cross-section)]

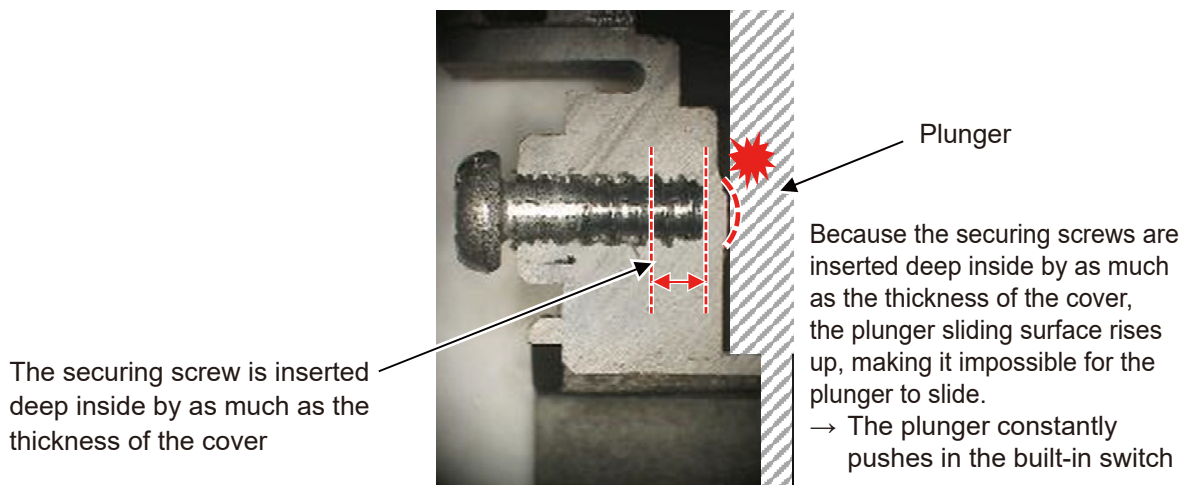

The securing screw is inserted deep inside by as much as the thickness of the cover

Because the securing screws are inserted deep inside by as much as the thickness of the cover, the plunger sliding surface rises up, making it impossible for the plunger to slide.

→ The plunger constantly pushes in the built-in switch

■ **Checkpoint for prevention!**



Check if the cover securing screws are tightened while the cover is open or is not installed.

If the cover securing screws are directly tightened with force when the cover is not installed, the securing screws are inserted deep inside by as much as the thickness of the cover, which obstructs the sliding of the plunger and may lead to conduction failure.

After the wiring work, be sure to close the cover and then tighten the securing screws.

m e m o

A series of horizontal dashed lines for writing.

Common for Safety Limit Switches

The mechanism of failure occurrence

Cause/reason

Insufficient operating/return stroke

Inflow of fluid into the switch

Possible failure when using the switch

<Contact failure>

- Although the actuator is operating, power is either not supplied, or the power supply is unstable.
- Although the actuator is operating, power is supplied constantly.

<Contact failure>

- The contact does not turn ON or is unstable.
- The contact is constantly powered on.

D4N

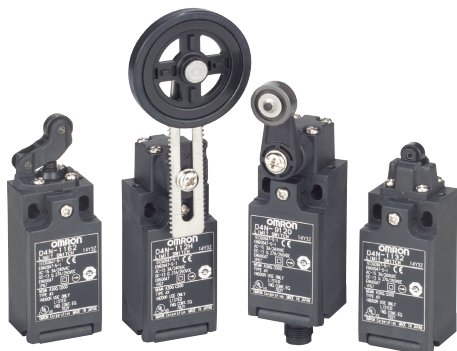

D4F



D4B-□N



D4N-□R

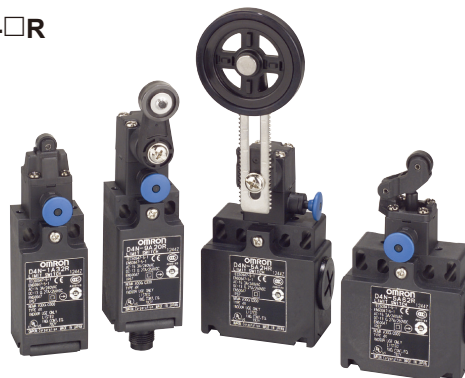

Direct causes leading to failures	Checkpoint for prevention (measures)
Unstable contact	<ul style="list-style-type: none">• Do not set the actuator ON/OFF operation near the contact switching position.• Make sure there is no looseness in the switch installation screws, or deformation of the operating body.
Corrosion of contact	<ul style="list-style-type: none">• Do not use the switch in oil or water, or in an environment where the switch is constantly exposed to water or oil.• Tighten each screw to an appropriate tightening torque.

[If the operating/return stroke is insufficient...]

■ What are the possible failures?



<Contact failure>

- Although the actuator is operating, power is either not supplied, or the power supply is unstable.
- Although the actuator is operating, power is supplied constantly.

■ Checkpoint for prevention!



(1) Check if the actuator ON/OFF operation is set near the contact switching position.

The contact is unstable in the area near the contact switching position (OP: Operating position, RP: Reversing position), and therefore, a conduction failure may occur.

In such a case, the switch becomes susceptible to vibrations and impacts as well.

When using a normally open switch (NO), ensure an operating stroke of 80% to 100% of the OT (over-travel) stipulated value.

When using a normally closed switch (NC), set the stroke such that the operating body is completely separated from the actuator and the switch returns up to the FP (free position), and a slight deviation or error is absorbed.

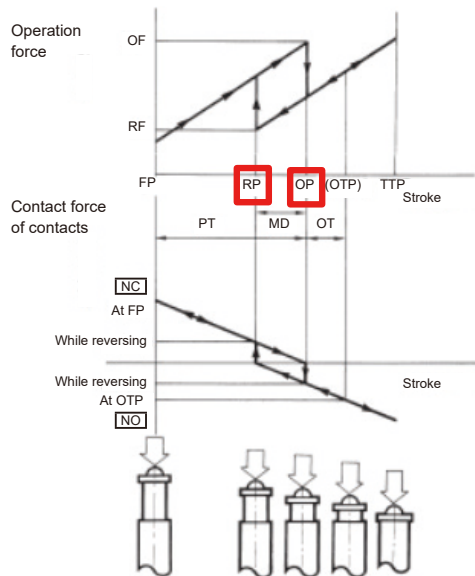

□part: Contact switching position, which is the area where the contact tends to be unstable



(2) Check if there is looseness in the switch installation screws, or deformation of the operating body.

If the switch installation screws are loose, or the operating body is deformed or distorted, normal operation may not be performed in spite of the correct stroke setting.

Even if there is no initial problem, the failure described above may occur as time passes, and therefore, be careful when installing the switch and also perform periodic inspection.

[If fluid enters inside the switch...]

■ What are the possible failures?



<Contact failure>

- The contact does not turn ON or is unstable.
- The contact is constantly powered on.

■ The failure case

- If the switch is installed at a location where the cutting oil is scattered at all times

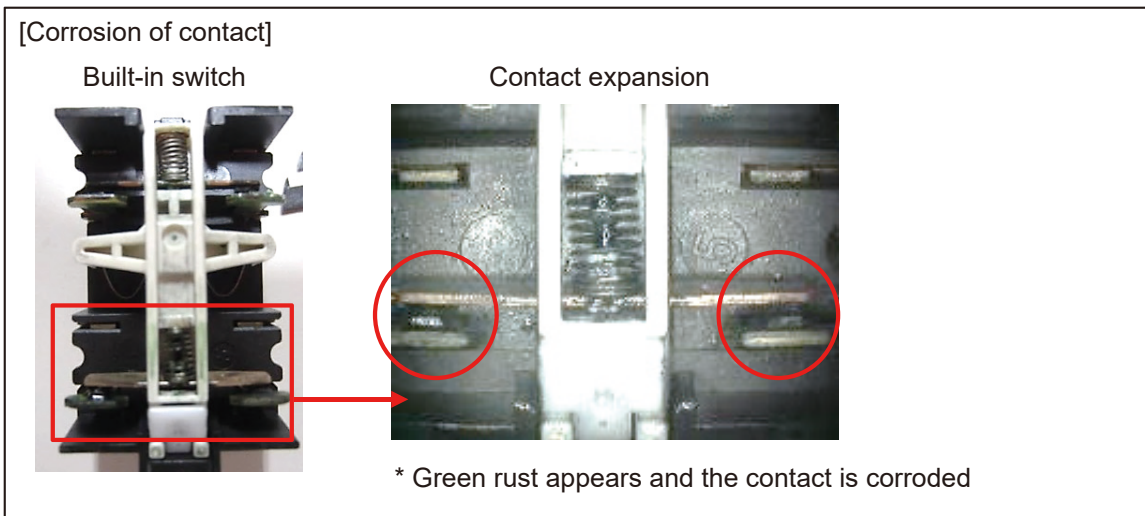

* The photograph shows a case of inflow of oil in the D4N built-in switch

■ Checkpoint for prevention!



(1) Check if oil is constantly deposited on the switch.

Do not use the switch in oil or water, or in an environment where the switch is constantly exposed to water or oil as the water or oil may enter inside the switch.

Alternatively, examine measures of preventing the entry of fluid by changing the switch installation location or installing a protective cover.

The safety limit switches (D4N, D4F, D4B-□N, D4N-□R) have a protective structure IP67 (drip-proof switches) and are not completely water-proof.



(2) Check if the screw is loose at any part.

The looseness in screws causes moisture or oil to enter inside the switch, resulting in corrosion or short-circuiting. Therefore, tighten each part to the appropriate tightening torque.

[D4N]

(1)	Terminal screw	0.6 to 0.8 N•m
(2)	Cover mounting screw	0.5 to 0.7 N•m
(3)	Head mounting screw	0.5 to 0.6 N•m
(4)	Lever mounting screw	1.6 to 1.8 N•m
(5)	Body mounting screw	0.5 to 0.7 N•m
(6)	Connector, M12 adapter	1.8 to 2.2 N•m
(7)	Cap screw	1.3 to 1.7 N•m

[D4B-□N]

No.	Type	Appropriate tightening torque
(1)	M3.5 terminal screw	0.59 to 0.78 N•m
(2)	Cover mounting screw	1.18 to 1.37 N•m
(3)	Head mounting screw	0.78 to 0.88 N•m
(4)	M5 body mounting screw	4.90 to 5.88 N•m
(5)	Connector	1.77 to 2.16 N•m
(6)	Lever Mounting Screws (Roller Levers)	4.90 to 5.88 N•m

m e m o

A series of horizontal dashed lines for writing a memo.

Common for Safety Door Switches / Safety Limit Switches

The mechanism of failure occurrence

Cause/reason

Presence of a silicon gas in the vicinity

Possible failure when using the switch

<Contact failure>
The switch does not turn ON.
The contact resistance is high, or the contact is unstable.

D4SL-N



D4NL



D4NS

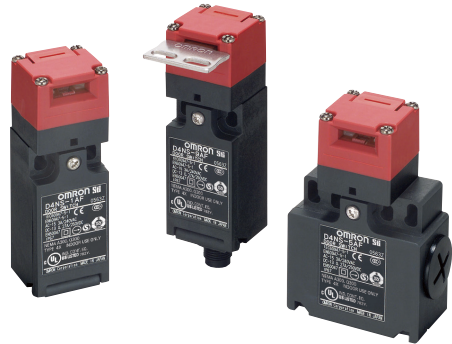

D4JL

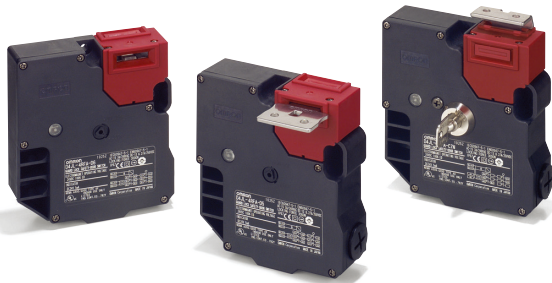

D4GS-N



D4NH



D4BS



D4BL

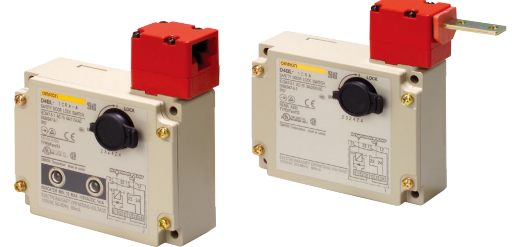

Direct causes leading to failures

Generation of silicon oxide on the contact surface

Checkpoint for prevention (measures)

If a silicon-based material is used near the switch or in the parting agent of molded products, either eliminate or change the material.

D4N

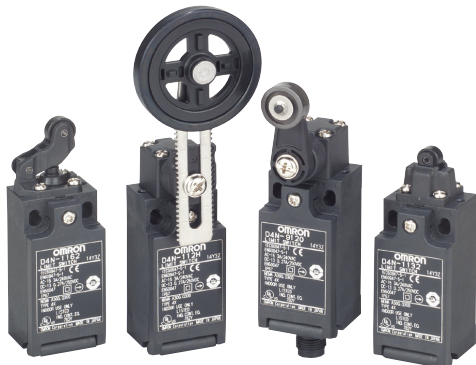

D4F



D4B-□N

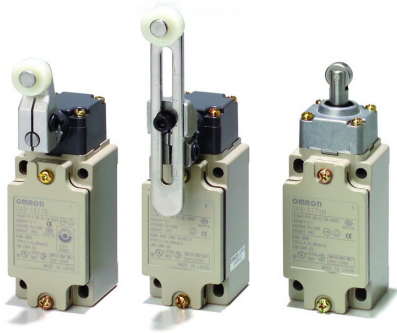

D4N-□R

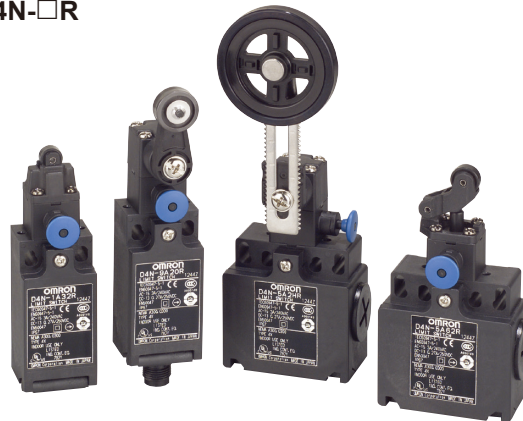

[If a silicon gas is present in the vicinity...]

■ What are the possible failures?



<Contact failure>

The switch does not turn ON.

The contact resistance is high, or the contact is unstable.

■ The failure case

- If a material containing a silicon component is present near the switch, silicon oxide is generated in the contact
Example) D4N

Photograph of a contact



Generation of black-colored foreign material is seen

Elemental analysis result of ○ part

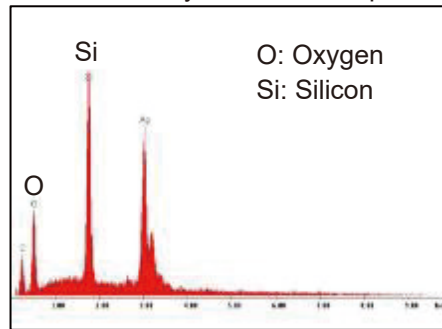

Detection of silicon oxide

■ Checkpoint for prevention!



Check if a material containing a silicon (siloxane with a low molecular weight) component is present near the switch you are using.

Examples of sources generating a silicon gas are as follows:

[Source]

Silicone-based coating agents, silicone-based adhesives, silicone rubber, silicone oil/grease, silicone-based mold release agents, silicone fillers, silicone wires, and the like

Silicon oxide is generated on the contact surface when the gas emitted from the silicon-based material present near the switch reacts with the arc heat during a load break.

If a source generating a silicone gas is present, be sure to suppress the arc by a contact protective circuit, or eliminate the source from near the switch or change to other materials.

As an example, silicon-based mold release agents may be used in molds in the case of molded products. Make sure such materials are not present in the vicinity.

(We use fluorine-based mold release agents in our switches.)

Silicon oxide is generated on the contact surface when the gas emitted from the silicon-based material present near the switch reacts with the arc heat during a load break.

(1) Siloxane with a low molecular weight is volatilized from silicon-based materials

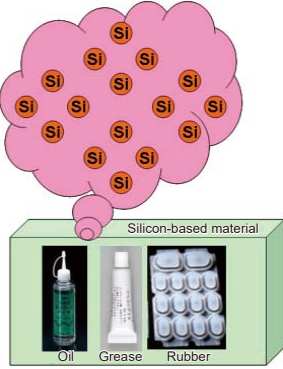

(2) The volatilized siloxane with low molecular weight reaches near the contacts

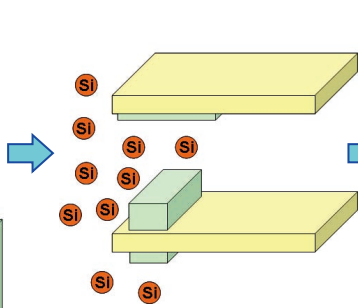

(3) An arc is generated due to the opening/closing of contacts

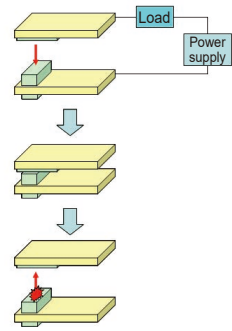

(4) The siloxane with a low molecular weight decomposes as a result of the arc heat to generate silicon oxide

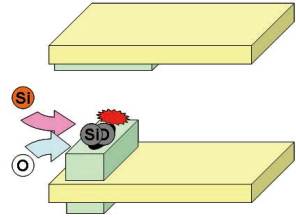

m e m o

A series of horizontal dashed lines for writing a memo.

Terms and Conditions Agreement

Read and understand this catalog.

Please read and understand this catalog before purchasing the products. Please consult your OMRON representative if you have any questions or comments.

Warranties.

- (a) Exclusive Warranty. Omron's exclusive warranty is that the Products will be free from defects in materials and workmanship for a period of twelve months from the date of sale by Omron (or such other period expressed in writing by Omron). Omron disclaims all other warranties, express or implied.
- (b) Limitations. OMRON MAKES NO WARRANTY OR REPRESENTATION, EXPRESS OR IMPLIED, ABOUT NON-INFRINGEMENT, MERCHANTABILITY OR FITNESS FOR A PARTICULAR PURPOSE OF THE PRODUCTS. BUYER ACKNOWLEDGES THAT IT ALONE HAS DETERMINED THAT THE PRODUCTS WILL SUITABLY MEET THE REQUIREMENTS OF THEIR INTENDED USE.

Omron further disclaims all warranties and responsibility of any type for claims or expenses based on infringement by the Products or otherwise of any intellectual property right. (c) Buyer Remedy. Omron's sole obligation hereunder shall be, at Omron's election, to (i) replace (in the form originally shipped with Buyer responsible for labor charges for removal or replacement thereof) the non-complying Product, (ii) repair the non-complying Product, or (iii) repay or credit Buyer an amount equal to the purchase price of the non-complying Product; provided that in no event shall Omron be responsible for warranty, repair, indemnity or any other claims or expenses regarding the Products unless Omron's analysis confirms that the Products were properly handled, stored, installed and maintained and not subject to contamination, abuse, misuse or inappropriate modification. Return of any Products by Buyer must be approved in writing by Omron before shipment. Omron Companies shall not be liable for the suitability or unsuitability or the results from the use of Products in combination with any electrical or electronic components, circuits, system assemblies or any other materials or substances or environments. Any advice, recommendations or information given orally or in writing, are not to be construed as an amendment or addition to the above warranty.

See <http://www.omron.com/global/> or contact your Omron representative for published information.

Limitation on Liability; Etc.

OMRON COMPANIES SHALL NOT BE LIABLE FOR SPECIAL, INDIRECT, INCIDENTAL, OR CONSEQUENTIAL DAMAGES, LOSS OF PROFITS OR PRODUCTION OR COMMERCIAL LOSS IN ANY WAY CONNECTED WITH THE PRODUCTS, WHETHER SUCH CLAIM IS BASED IN CONTRACT, WARRANTY, NEGLIGENCE OR STRICT LIABILITY.

Further, in no event shall liability of Omron Companies exceed the individual price of the Product on which liability is asserted.

Suitability of Use.

Omron Companies shall not be responsible for conformity with any standards, codes or regulations which apply to the combination of the Product in the Buyer's application or use of the Product. At Buyer's request, Omron will provide applicable third party certification documents identifying ratings and limitations of use which apply to the Product. This information by itself is not sufficient for a complete determination of the suitability of the Product in combination with the end product, machine, system, or other application or use. Buyer shall be solely responsible for determining appropriateness of the particular Product with respect to Buyer's application, product or system. Buyer shall take application responsibility in all cases.

NEVER USE THE PRODUCT FOR AN APPLICATION INVOLVING SERIOUS RISK TO LIFE OR PROPERTY OR IN LARGE QUANTITIES WITHOUT ENSURING THAT THE SYSTEM AS A WHOLE HAS BEEN DESIGNED TO ADDRESS THE RISKS, AND THAT THE OMRON PRODUCT(S) IS PROPERLY RATED AND INSTALLED FOR THE INTENDED USE WITHIN THE OVERALL EQUIPMENT OR SYSTEM.

Programmable Products.

Omron Companies shall not be responsible for the user's programming of a programmable Product, or any consequence thereof.

Performance Data.

Data presented in Omron Company websites, catalogs and other materials is provided as a guide for the user in determining suitability and does not constitute a warranty. It may represent the result of Omron's test conditions, and the user must correlate it to actual application requirements. Actual performance is subject to the Omron's Warranty and Limitations of Liability.

Change in Specifications.

Product specifications and accessories may be changed at any time based on improvements and other reasons. It is our practice to change part numbers when published ratings or features are changed, or when significant construction changes are made. However, some specifications of the Product may be changed without any notice. When in doubt, special part numbers may be assigned to fix or establish key specifications for your application. Please consult with your Omron's representative at any time to confirm actual specifications of purchased Product.

Errors and Omissions.

Information presented by Omron Companies has been checked and is believed to be accurate; however, no responsibility is assumed for clerical, typographical or proofreading errors or omissions.

OMRON Corporation Industrial Automation Company
Kyoto, JAPAN

Contact: www.ia.omron.com

Regional Headquarters

OMRON EUROPE B.V.

Wegalaan 67-69, 2132 JD Hoofddorp
The Netherlands
Tel: (31)2356-81-300/Fax: (31)2356-81-388

OMRON ELECTRONICS LLC

2895 Greenspoint Parkway, Suite 200
Hoffman Estates, IL 60169 U.S.A.
Tel: (1) 847-843-7900/Fax: (1) 847-843-7787

OMRON ASIA PACIFIC PTE. LTD.

No. 438A Alexandra Road # 05-05/08 (Lobby 2),
Alexandra Technopark,
Singapore 119967
Tel: (65) 6835-3011/Fax: (65) 6835-2711

OMRON (CHINA) CO., LTD.

Room 2211, Bank of China Tower,
200 Yin Cheng Zhong Road,
PuDong New Area, Shanghai, 200120, China
Tel: (86) 21-5037-2222/Fax: (86) 21-5037-2200

Authorized Distributor:

© OMRON Corporation 2021 All Rights Reserved.
In the interest of product improvement,
specifications are subject to change without notice.

Cat. No. F116-E1-01

0321