

Machine Automation Controller NJ-series

IO-Link Connection Guide (EtherCAT(R) Host Communications)

OMRON Corporation

Proximity Sensor
(E2E-series IO-Link)

[IO-Link Master Unit]
OMRON Corporation
GX-series IO-Link Master Unit
(GX-ILM[][][][]))



Network
Connection
Guide

About Intellectual Property Rights and Trademarks

Microsoft product screen shots reprinted with permission from Microsoft Corporation.

Windows is a registered trademark of Microsoft Corporation in the USA and other countries.

EtherCAT(R) is registered trademark and patented technology, licensed by Beckhoff Automation GmbH, Germany.

Sysmac is a trademark or registered trademark of OMRON Corporation in Japan and other countries for OMRON factory automation products.

Company names and product names in this document are the trademarks or registered trademarks of their respective companies.

Table of Contents

1. Related Manuals	1
2. Terms and Definitions	2
3. Precautions	3
4. Overview	4
5. Applicable Devices and Device Configuration	5
5.1. Applicable Devices	5
5.2. Device Configuration.....	6
6. Communications Settings	2
6.1. EtherCAT Connection Parameter	2
6.2. IO-Link Connection Parameter	2
6.3. Device Variables.....	2
7. IO-Link Connection Procedure	5
7.1. Work Flow	5
7.2. EtherCAT Slave Unit Setup.....	2
7.3. Network Configuration for Host Communications.....	4
7.4. IO-Link Master Unit Setup.....	8
7.5. Controller Setup	11
7.6. IO-Link Communication Status Check.....	18
8. Initialization method	26
8.1. Initializing Controller.....	26
8.2. Initializing IO-Link Master Unit	27
8.3. Initializing Proximity Sensor	27
9. Revision History	28

1. Related Manuals

To ensure system safety, make sure to always read and follow the information provided in all Safety Precautions and Precautions for Safe Use in the manuals for each device which is used in the system.

The table below lists the manuals which pertain to this document.

Cat. No.	Model	Manual name
W500	NJ501-□□□□ NJ301-□□□□ NJ101-□□□□	NJ-series CPU Unit Hardware User's Manual
W501	NJ501-□□□□ NJ301-□□□□ NJ101-□□□□	NJ/NX-series CPU Unit Software User's Manual
W505	NJ501-□□□□ NJ301-□□□□ NJ101-□□□□	NJ/NX-series CPU Unit Built-in EtherCAT(R) Port User's Manual
W504	SYSMAC-SE2□□□□	Sysmac Studio Version 1 Operation Manual
W488	GX-ILM□□□□	EtherCAT Remote I/O Terminal GX-series EtherCAT Slave Units User's Manual
W570	NX-ILM□□□□ GX-ILM□□□□	IO-Link System User's Manual
W570	NX-ILM□□□□ GX-ILM□□□□	IO-Link System User's Manual
9540393-4	E2E(Q)-□-IL□	PROXIMITY SENSOR INSTRUCTION SHEET
9540292-0	E2E(Q)-□-IL□	PROXIMITY SENSOR INDEX LIST

2. Terms and Definitions

Term	Explanation and Definition
IO-Link device	A device with a sensor or an actuator that can perform IO-Link communications with an IO-Link master.
IO-Link master	A device that performs IO-Link communications with IO-Link devices in an IO-Link System and that simultaneously functions as a slave for host communications. "IO-Link Master Unit" is used to refer to a specific Unit in this document.
IO-Link Mode	A communication mode of an IO-Link master to perform IO-Link communications with IO-Link devices.
Cyclic communications	Communications that exchange data in a fixed period with no need for programming.
I/O data	All target data in cyclic communications with a host. IO-Link Systems contain the following two types of I/O data. <ul style="list-style-type: none"> • Target data in cyclic communications with a host in an IO-Link master • Target data in IO-Link devices for cyclic communications with an IO-Link master
Process data	I/O data in IO-Link devices. You can allocate a maximum of 32 bytes of process data in a master.
IODD file	A definition file for an IO-Link device. The parameter settings for an IO-Link device can be made by installing this file in CX-ConfiguratorFDT.
Slave unit	A generic name for a device that performs EtherCAT communications with an EtherCAT master in an EtherCAT system. There are various types of slaves such as servo drives that handle position data and I/O terminals that handle bit signals.
Node address	A node address is an address to identify a unit connected to EtherCAT.
ESI file	An ESI file contains information unique to EtherCAT slave units in XML format. Installing an ESI file enables Sysmac Studio to allocate EtherCAT slave process data and make other settings.

3. Precautions

- (1) Understand the specifications of devices which are used in the system. Allow some margin for ratings and performance. Provide safety measures, such as installing a safety circuit, in order to ensure safety and minimize the risk of abnormal occurrence.
- (2) To ensure system safety, make sure to always read and follow the information provided in all Safety Precautions and Precautions for Safe Use in the manuals for each device which is used in the system.
- (3) The user is encouraged to confirm the standards and regulations that the system must conform to.
- (4) It is prohibited to copy, to reproduce, and to distribute a part or the whole of this document without the permission of OMRON Corporation.
- (5) The information contained in this document is current as of August 2016. It is subject to change for improvement without notice.

The following notations are used in this document.

 WARNING	Indicates a potentially hazardous situation which, if not avoided, may result in minor or moderate injury, or may result in serious injury or death. Additionally there may be significant property damage.
--	---

 Caution	Indicates a potentially hazardous situation which, if not avoided, may result in minor or moderate injury or property damage.
--	---



Precautions for Correct Use

Precautions on what to do and what not to do to ensure proper operation and performance.



Additional Information

Additional information to read as required.

This information is provided to increase understanding or make operation easier.

Symbol



The filled circle symbol indicates operations that you must do. The specific operation is shown in the circle and explained in the text. This example shows a general precaution for something that you must do.

4. Overview

This document describes the procedures for connecting E2E-series IO-Link Proximity Sensor (hereinafter referred to as Proximity Sensor) that is connected via IO-Link to IO-Link Master Unit (GX-ILM[][][]) to NJ-series Machine Automation Controller (hereinafter referred to as Controller) via EtherCAT through IO-Link Master Unit and for checking their communication status - all of which are produced by OMRON Corporation.

Refer to *Section 6. Communications Settings* and *Section 7. IO-Link Connection Procedure* to understand setting methods and key points to perform cyclic communications in the IO-Link system.

Depending on the descriptions given in this document, IO-Link Master Unit is called "EtherCAT Slave Unit", and a generic EtherCAT slave for EtherCAT communications is called "slave unit".

< GX-series IO-Link Master Unit (GX-ILM[][][]) >

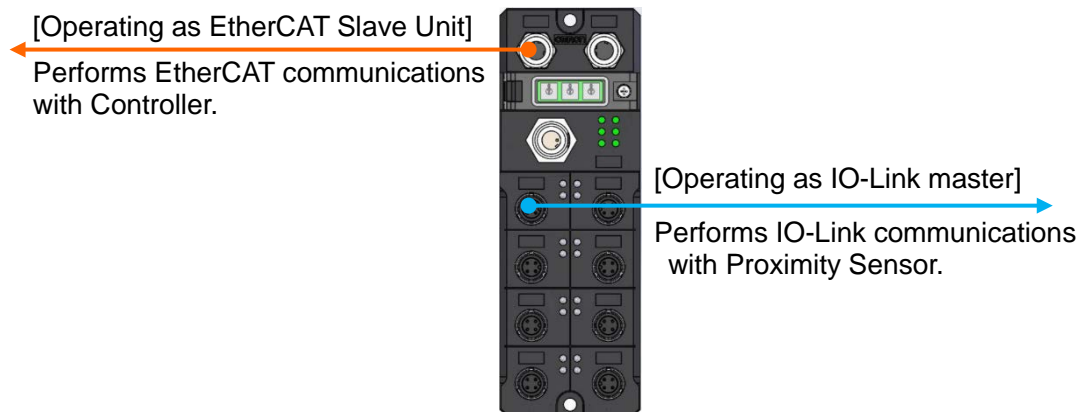

5. Applicable Devices and Device Configuration

5.1. Applicable Devices

The applicable devices are as follows:

Manufacturer	Name	Model
OMRON	NJ-series CPU Unit	NJ501-□□□□ NJ301-□□□□ NJ101-□□□□
OMRON	GX-series IO-Link Master Unit	GX-ILM□□□
OMRON	E2E-series IO-Link Proximity Sensor	E2E(Q)-□-IL□



Precautions for Correct Use

In this document, the devices with models and versions listed in 5.2. *Device Configuration* are used as examples of applicable devices to describe the procedures for connecting the devices and checking their connections.

You cannot use devices with versions lower than the versions listed in 5.2.

To use the above devices with models not listed in 5.2. or versions higher than those listed in 5.2., check the differences in the specifications by referring to the manuals before operating the devices.



Additional Information

This document describes the procedures for establishing the network connections.

It does not provide information on operation, installation, wiring method, device functionality, or device operation, which is not related to the connection procedures. Refer to the manuals or contact your OMRON representative.

5.2. Device Configuration

The hardware components to reproduce the connection procedures in this document are as follows:

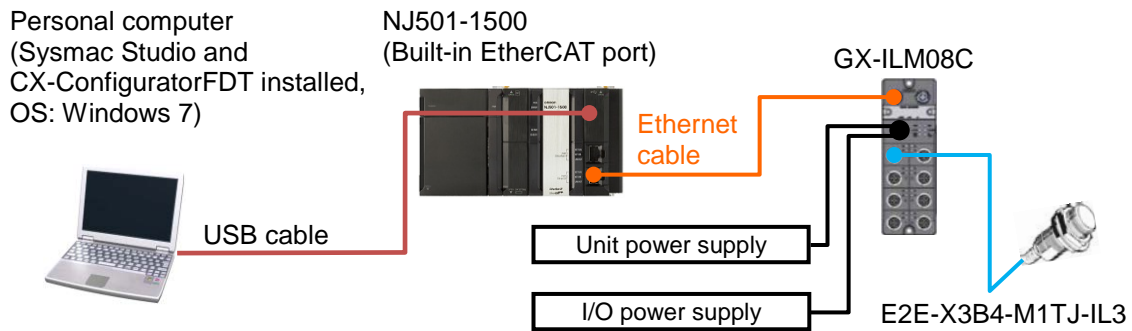

Manufacturer	Name	Model	Version
OMRON	NJ-series CPU Unit (Built-in EtherCAT port)	NJ501-1500	Ver.1.12
OMRON	Power Supply Unit	NJ-PA3001	
OMRON	Sysmac Studio	SYSMAC-SE2[] [] [] []	Ver.1.16
OMRON	CX-ConfiguratorFDT	(Included in Sysmac Studio)	Ver.2.2
-	Personal computer (OS: Windows 7)	-	
-	USB cable (USB 2.0 type B connector)	-	
OMRON	Ethernet cable (with industrial Ethernet connector)	XS5W-T421-[]M[]-K	
OMRON	GX-series IO-Link Master Unit	GX-ILM08C	Ver.1.0
-	Unit power supply (24 VDC)	-	
-	I/O power supply (24 VDC)	-	
OMRON	IO-Link Proximity Sensor	E2E-X3B4-M1TJ-IL3	Ver.1.00

Precautions for Correct Use

The connection line of EtherCAT communications cannot be shared with other Ethernet networks. Do not use devices for Ethernet such as a switching hub.

Use an Ethernet cable (double shielding with aluminum tape and braiding) of Category 5 or higher, and use a shielded connector of Category 5 or higher.

Connect the cable shield to the connector hood at both ends of the cable.

Precautions for Correct Use

Update Sysmac Studio and CX-ConfiguratorFDT to the versions specified in this *Clause 5.2.* or to higher versions. If you use a version higher than the one specified, the procedures and related screenshots described in *Section 7.* and subsequent sections may not be applicable. In that case, use the equivalent procedures described in this document by referring to the *Sysmac Studio Version 1 Operation Manual* (Cat. No. W504) and the *CX-ConfiguratorFDT Online Help*.



Additional Information

For specifications of Ethernet cables and network wiring, refer to *Section 4. EtherCAT Network Wiring* of the *NJ/NX-series CPU Unit Built-in EtherCAT(R) Port User's Manual* (Cat. No. W505).



Additional Information

For specifications of Unit and I/O power supplies for IO-Link Master Unit, refer to the *EtherCAT Remote I/O Terminal GX-series EtherCAT Slave Units User's Manual* (Cat. No. W488).



Additional Information

The system configuration in this document uses USB for the connection between Personal computer and Controller. For information on how to install the USB driver, refer to *A-1 Driver Installation for Direct USB Cable Connection* in *Appendices* of the *Sysmac Studio Version 1 Operation Manual* (Cat. No. W504).

6. Communications Settings

This section describes the contents of the parameters and device variables settings that are all defined in this document.

6.1. EtherCAT Connection Parameter

The parameter required for connecting Controller and IO-Link Master Unit (as EtherCAT Slave Unit) via EtherCAT is shown below.

<EtherCAT Slave Unit Setting>

Item	Set value	Remarks
Node address	1	Set the address using the hardware switches on IO-Link Master Unit.

6.2. IO-Link Connection Parameter

The parameter required for connecting IO-Link Master Unit and Proximity Sensor via IO-Link is shown below.

In this document, Proximity Sensor is connected to Port 1 on IO-Link Master Unit.

<IO-Link Master Unit Setting>

Item	Set value
Port1 IO-Link Device Configuration Data / Master Control	IO-Link Mode (Default)

6.3. Device Variables

The I/O data (process data) for Proximity Sensor are allocated to the Controller's device variables as PDO communications data for IO-Link Master Unit. The device variables are named automatically from a combination of the device names and the port names.

The device variables and the data types are shown in the following pages.



Additional Information

The device variables are named automatically from a combination of the device names and the port names.

The default device names are "E" followed by a serial number that starts from 001.



Additional Information

With Sysmac Studio, two methods can be used to specify an array for a data type.

After specifying, (1) is converted to (2), and the data type is always displayed as (2).

(1)BOOL[16] / (2)ARRAY[0..15] OF BOOL

In this document, the data type is simplified by displaying BOOL[16].

(The example above means a BOOL data type with sixteen array elements.)

■Output area (Controller to IO-Link Master Unit)

Device name	Variable	Data type	Description
E001	E001_Port1_Output_Data01	BYTE[2]	Port 1 Output Data01
	E001_Port2_Output_Data01	BYTE[2]	Port 2 Output Data01
	:	:	:
	E001_Port8_Output_Data01	BYTE[2]	Port 8 Output Data01

■Input area (IO-Link Master Unit to Controller)

Device name	Variable	Data type	Description
E001	E001_I_O_Port_Status	WORD	I/O Port Status
	E001_Port1_IN_Data_Enable	BOOL	Port1 IN Data Enable
	E001_Port2_IN_Data_Enable	BOOL	Port2 IN Data Enable
	:	:	:
	E001_Port8_IN_Data_Enable	BOOL	Port8 IN Data Enable
	E001_Communication_Module_Error	BOOL	Communication Module Error
	E001_IO_Power_On_Off_Status	BOOL	IO Power On/Off Status
	E001_Port1_2_I_O_Port_Error_Status	WORD	Port1_2 I/O Port Error Status
	E001_Port1_Communication_Error	BOOL	Port1 Communication Error
	E001_Port1_Short_Error	BOOL	Port1 Short Error
	E001_Port1_Compare_Error	BOOL	Port1 Compare Error
	E001_Port1_Device_IO_Size_Error	BOOL	Port1 Device IO Size Error
	E001_Port1_Device_Error	BOOL	Port1 Device Error
	E001_Port1_Device_Information	BOOL	Port1 Device Warning
	E001_Port1_PDO_Error	BOOL	Port1 PDO Error
	E001_Port2_Communication_Error	BOOL	Port2 Communication Error
	: (Same status as for Port 1)	:	:
	E001_Port3_4_I_O_Port_Error_Status	WORD	Port3_4 I/O Port Error Status
	: (Same status as for Port1_2)	:	:
	E001_Port5_6_I_O_Port_Error_Status	WORD	Port5_6 I/O Port Error Status
	: (Same status as for Port1_2)	:	:
	E001_Port7_8_I_O_Port_Error_Status	WORD	Port7_8 I/O Port Error Status
	: (Same status as for Port1_2)	:	:
	E001_Port1_Input_Data01	BYTE[2]	Port 1 Input Data01 <Stores the I/O data for Proximity Sensor.>
	[0]	BYTE	<Stores Byte0 (PD0).>
	[1]	BYTE	<Stores Byte1 (PD1).>
	E001_Port2_Input_Data01	BYTE[2]	Port 2 Input Data01
	:	:	:
	E001_Port8_Input_Data01	BYTE[2]	Port 8 Input Data01
	E001_New_Messages_Available	BOOL	New Messages Available
	E001_Sysmac_Error_Status	BYTE	Sysmac Error Status
	E001_Observation	BOOL	Observation levels of information
	E001_Minor_Fault	BOOL	Minor Fault levels of information

■I/O data (process data) for Proximity Sensor

(Data to be stored in the device variable *E001_Port1_Input_Data01* listed in the table for the input area)

Byte0 (PD0)								割り当て Assignment	詳細 Details
7	6	5	4	3	2	1	0	モニタ出力 Monitor Output	センシングの検出量を8bit (0-255)で出力する 詳細は6項を参照。 The sensing data are output as eight bits(0-255). For details, refer to Section 6

Byte1 (PD1)								割り当て Assignment	詳細 Details
7	6	5	4	3	2	1	0	制御出力 Control Output	0: OFF 1: ON
								— Reserved	0
								— Reserved	0
								— Reserved	0
								不安定検出アラーム Instability Detection Alarm	0: 安定状態 Stable 1: 不安定状態 Unstable
								過接近検出アラーム Target too Close Alarm	0: 安定状態 Not close 1: 過接近状態 Too close
								— Reserved	0
								異常 Error	検出コイル断線等センサ内部に異常が発生しており、 交換が必要な場合の診断出力 This is the diagnostic output issued when an error such as disconnection of the detection coil has occurred inside the sensor and the sensor must be replaced. 0:正常 Normal (OFF) 1: 異常 Error (ON)

7. IO-Link Connection Procedure

This section describes the procedures for connecting Proximity Sensor to IO-Link Master Unit via IO-Link and for connecting Controller to IO-Link Master Unit on the EtherCAT network.

The explanations of procedures for setting up Controller and IO-Link Master Unit given in this document are based on the factory default settings.

For the initialization, refer to *Section 8. Initialization Method*.

7.1. Work Flow

Take the following steps to connect Proximity Sensor to IO-Link Master Unit via IO-Link and to connect Controller to IO-Link Master Unit on the EtherCAT network.

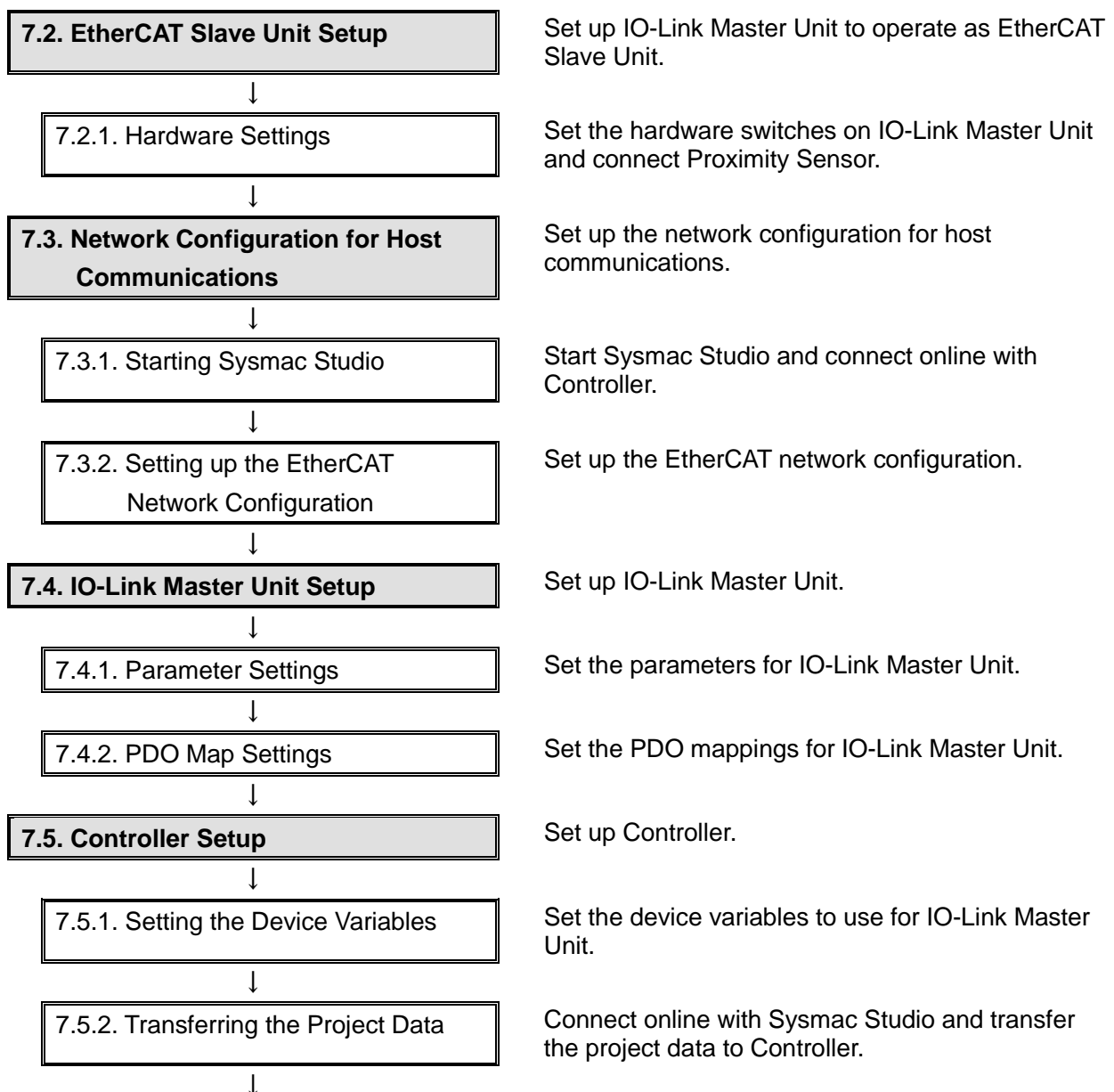

7.6. IO-Link Communication Status Check

Confirm that cyclic communications in the IO-Link system performs normally.



7.6.1. Checking the Connection Status

Check the connection status of each device.



7.6.2. Checking the Receive Data

Check that the correct data are received.

7.2. EtherCAT Slave Unit Setup

Set up IO-Link Master Unit to operate as EtherCAT Slave Unit.

7.2.1. Hardware Settings

Set the hardware switches on IO-Link Master Unit and connect Proximity Sensor.



Precautions for Correct Use

Make sure that the power supply is OFF when you set up.

- 1 Make sure that IO-Link Master Unit is powered OFF.

*If it is ON, the settings described in the following steps and subsequent procedures may not be applicable.

- 2 Check the position of the hardware switches on IO-Link Master Unit by referring to the figure on the right.

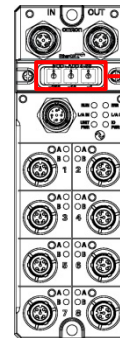

- 3 Set Node address setting switches as follows:

- Node address setting switches
- $x16^0$: 1
- $x16^1$: 0
- $x16^2$: 0



Node address setting switches

Node address setting ($x16^0$)
 Node address setting ($x16^1$)
 Node address setting ($x16^2$)

*The node address is set to 1.

- 4 Connect an Ethernet cable to EtherCAT communications connector, IN on IO-Link Master Unit.

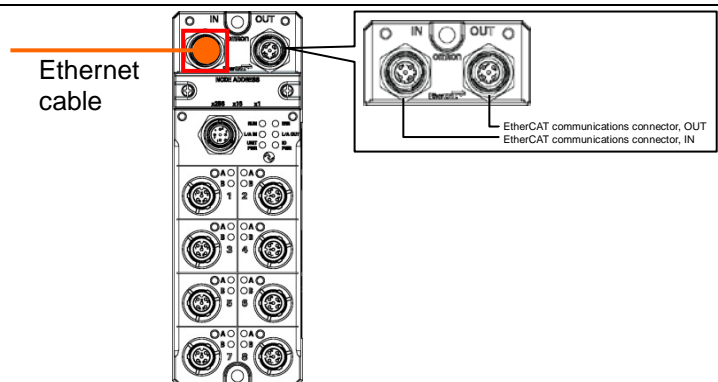

5 Connect Unit power supply and I/O power supply to Power supply connector.

*For connecting the power supplies for GX-series EtherCAT Slave Units, refer to 4.3. *Connecting to Unit Power Supply and I/O Power Supply of the EtherCAT Remote I/O Terminal GX-series EtherCAT Slave Units User's Manual* (Cat. No. W488).

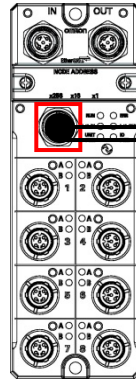

Power Supply Connector

Pin	Signal	Description
1	UNT_P+	Unit power supply +
2	UNT_P-	Unit power supply -
3	I/O_P+	I/O power supply +
4	I/O_P-	I/O power supply -
5	-	Not used.

6 Connect Proximity Sensor to Port 1 of IO connector on IO-Link Master Unit.

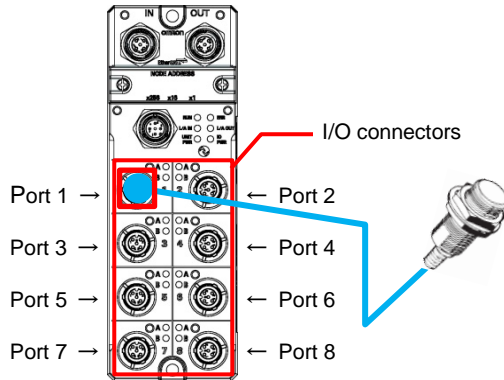

7.3. Network Configuration for Host Communications

Set up the network configuration for host communications.

7.3.1. Starting Sysmac Studio

Start Sysmac Studio and connect online with Controller.

Install Sysmac Studio and the USB driver on Personal computer beforehand.



Additional Information

For details on the online connections to Controller, refer to *Section 6. Online Connections to a Controller* of the *Sysmac Studio Version 1 Operation Manual* (Cat. No. W504).

<p>1 Connect the Ethernet cable to the built-in EtherCAT port (PORT2) on Controller, and connect a USB cable to the peripheral (USB) port. As shown in 5.2. <i>Device Configuration</i>, connect Personal computer and IO-Link Master Unit to Controller.</p>	
<p>2 Turn ON Controller and Unit power supply for IO-Link Master Unit.</p> <p>*The I/O power supply for IO-Link Master Unit remains OFF.</p>	
<p>3 Start Sysmac Studio.</p> <p>*If the User Account Control Dialog Box is displayed at start, make a selection to start Sysmac Studio.</p>	
<p>4 Sysmac Studio starts. Click Connect to Device.</p>	

5 The Connect to Device Dialog Box is displayed.
 Select *Direct connection via USB* in the *Connection type* Field.
 Uncheck both *Transfer from Device* and *Display the Troubleshooting Dialog Box* in the *Operation after Connection* Field.

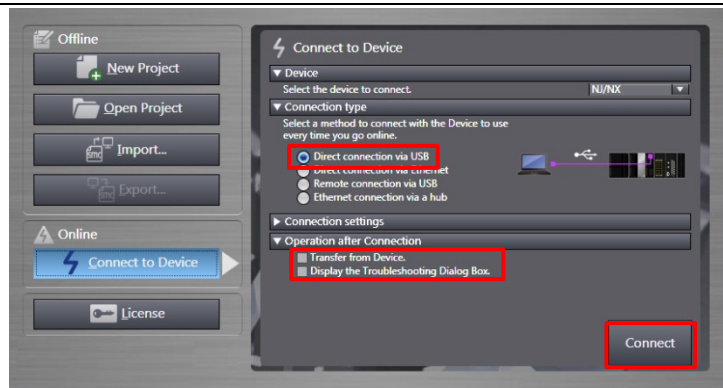

Click **Connect**.

6 A confirmation dialog box is displayed. Check the contents and click **OK**.

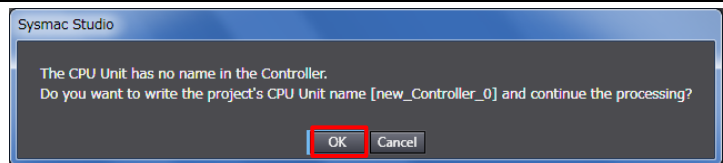

*The displayed dialog depends on the status of Controller. Check the contents and click on an appropriate button to proceed with the processing.

7 The dialog box on the right is displayed. Check the contents and click **OK**.

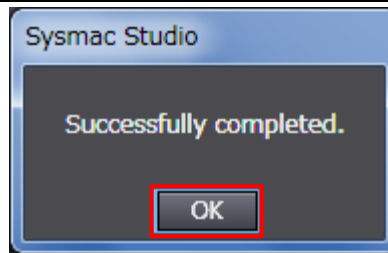

8 The Auto Connect Project Dialog Box is displayed online. When an online connection is established, a yellow bar is displayed under the toolbar.

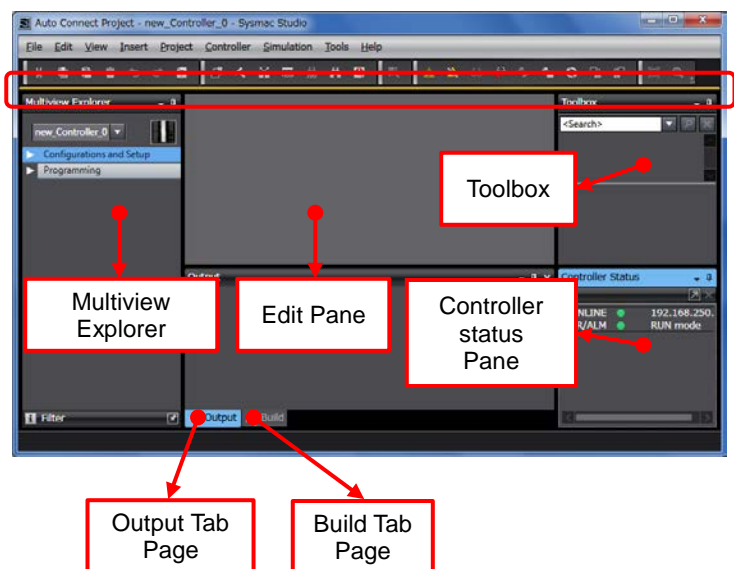

The following panes are displayed in this window.
 Left: Multiview Explorer
 Top right: Toolbox
 Bottom right: Controller Status Pane
 Top middle: Edit Pane
 The following tabs are displayed in the bottom middle of this window.
 Output Tab Page
 Build Tab Page

7.3.2. Setting up the EtherCAT Network Configuration

Set up the EtherCAT network configuration.

- 1 Double-click **EtherCAT** under **Configurations and Setup** in the Multiview Explorer.

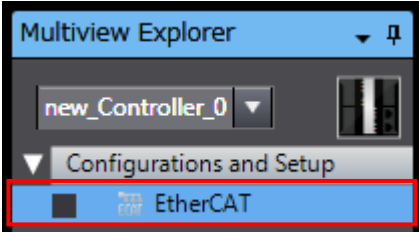

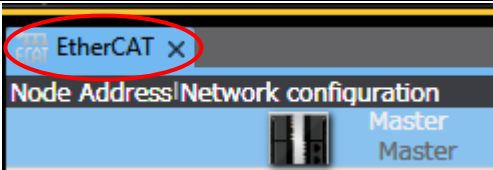
- 2 The EtherCAT Tab Page is displayed in the Edit Pane.

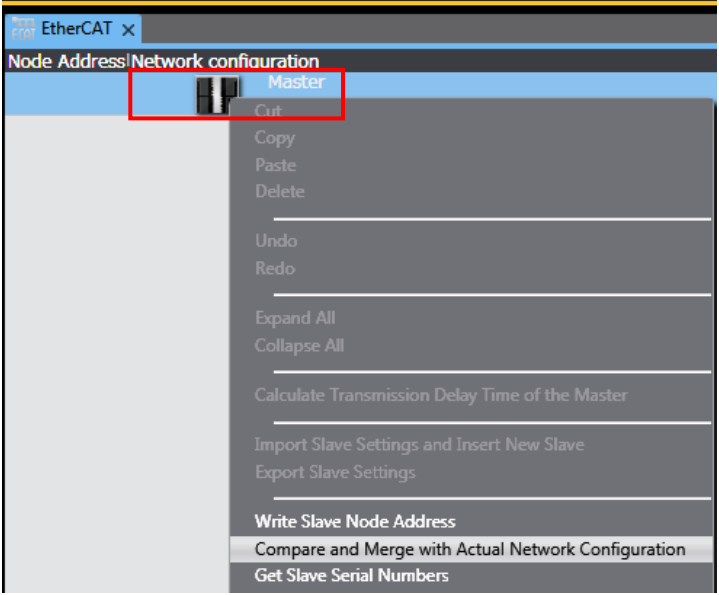
- 3 Right-click **Master** on the EtherCAT Tab Page in the Edit Pane and select **Compare and Merge with Actual Network Configuration**.



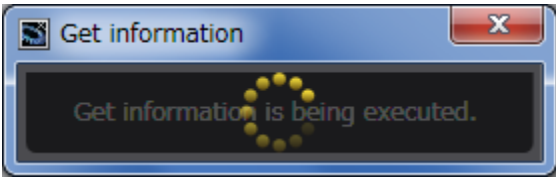

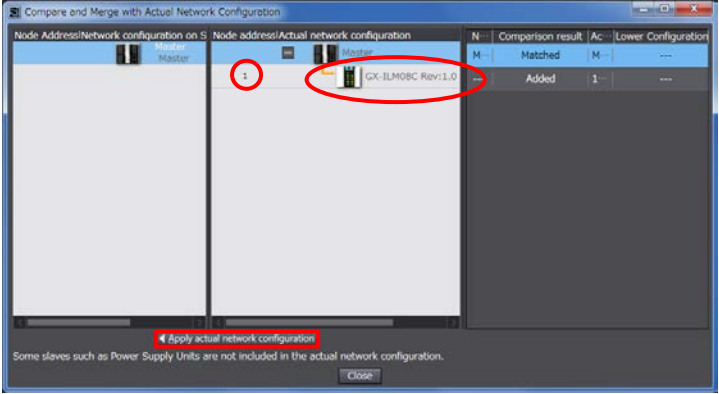

A screen is displayed stating "Get information is being executed".

- 4 The Compare and Merge with Actual Network Configuration Dialog Box is displayed. Node address 1 and GX-ILM08C Rev:1.0 are added to the Actual network configuration after the comparison.

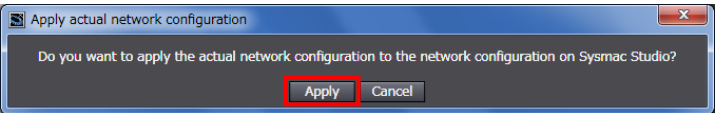

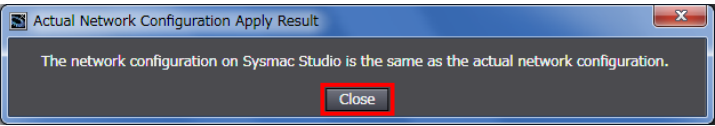
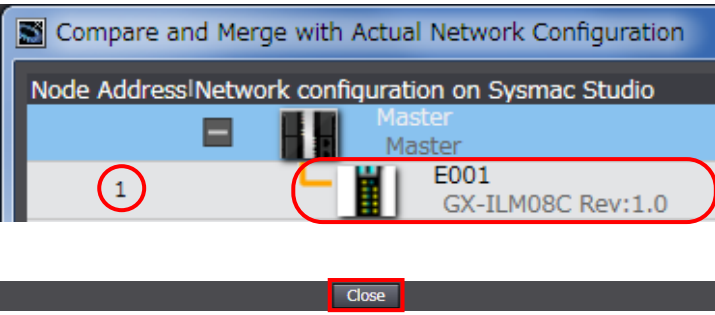
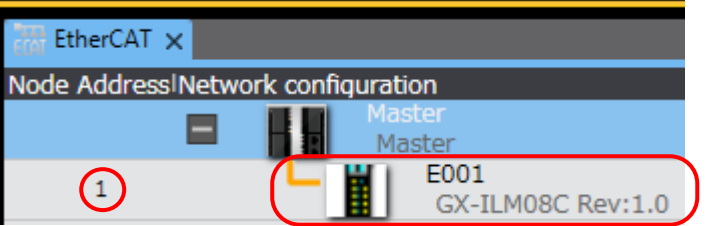
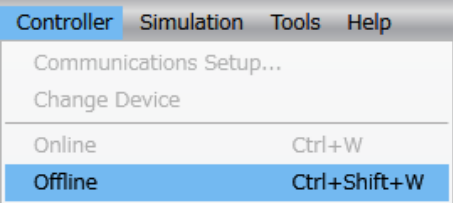
Click **Apply actual network configuration**.

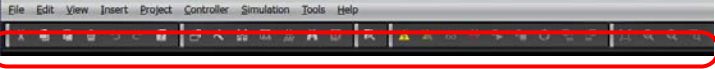
<p>5 The dialog box on the right is displayed. Check the contents and click Apply.</p> <p>The dialog box on the right is displayed. Check the contents and click Close.</p>	  
<p>6 As a node address 1 slave, E001 GX-ILM08C Rev:1.0 is added to the Network configuration on Sysmac Studio.</p> <p>Check that the data above is added. Click Close.</p>	
<p>7 Node address 1 and E001 GX-ILM08C Rev:1.0 are added to the EtherCAT Tab Page in the Edit Pane.</p>	
<p>8 Select Offline from the Controller Menu.</p> <p>The yellow bar under the toolbar disappears.</p>	  

7.4. IO-Link Master Unit Setup

Set up IO-Link Master Unit.

7.4.1. Parameter Settings

Set the parameters for IO-Link Master Unit.

In this document, the default values are used for the parameter settings of IO-Link Master Unit. Check that IO-Link Mode is set as the communications mode for Port 1 to which Proximity Sensor is connected.



Additional Information

If you use the functions such as the connected device verification and the backup and restoration of parameter settings in IO-Link devices, refer to the *EtherCAT Remote I/O Terminal GX-series EtherCAT Slave Units User's Manual* (Cat. No. W488) and the *IO-Link System User's Manual* (Cat. No. W570).

<p>1 Select GX-ILM08C Rev:1.0 on the EtherCAT Tab Page in the Edit Pane. Check that the device name is E001.</p> <p>*The device name can be changed as desired. The device name you set is used at the beginning of the device variable name.</p> <p>Click Edit Backup Parameter Settings.</p>	
<p>2 The Node1:GX-ILM08C (E001) Tab Page is displayed.</p>	

- 3 Check that IO-Link Mode is selected as the set value of 0x8000:28 Port1 IO-Link Device Configuration Data/Master Control by scrolling up or down the table for setting values.

*If IO-Link Mode is not displayed in the *Value* Column, select the mode from the pull-down list.

Click **OK**.

The screenshot shows the EtherCAT configuration interface for Node1: GX-ILM08C (E001). A table lists various configuration items with their corresponding values. The item '0x8000:28 Port1 IO-Link Device Configuration Data/Master Control' is highlighted, and its value is '3: IO-Link Mode', which is shown in a pull-down list. The 'OK' button at the bottom is also highlighted.

Item name	Value
0x8000:04 Port1 IO-Link Device Configuration Data/Device ID	0
0x8000:05 Port1 IO-Link Device Configuration Data/Vendor ID	0
0x8000:20 Port1 IO-Link Device Configuration Data/IO-Link Revision	0
0x8000:24 Port1 IO-Link Device Configuration Data/Process Data In Length	2
0x8000:25 Port1 IO-Link Device Configuration Data/Process Data Out Length	2
0x8000:28 Port1 IO-Link Device Configuration Data/Master Control	3: IO-Link Mode
0x8001:00 Port1 Serial Number Configuration Data/Port1 Serial Number C...	
0x8010:04 Port2 IO-Link Device Configuration Data/Device ID	0

Help
Data type : ---
Comment : IO-Link communication mode setting
0: Inactive
1: SIO(DI) Mode
2: SIO(DO) Mode
3: IO-Link Mode

Buttons: Transfer to Slave, Transfer from Slave, Compare, Return to Default, OK, Cancel, Apply

7.4.2. PDO Map Settings

Set the PDO mappings for IO-Link Master Unit.

As the default values are used for the PDO mappings in this document, the PDO entries are made without editing any of the values.



Additional Information

To save the I/O data size for unused ports, delete the PDO entries for the unused ports from the PDO map settings.

The Edit PDO Map Settings Window is displayed by clicking **Edit PDO Map Settings** shown on the right.

For information on how to edit, refer to the *IO-Link System User's Manual* (Cat. No. W570).

Item name	Value
Device name	E001
Model name	GX-ILM08C
Product name	GX-ILM08C GX-Series IP67...
Revision	1.0
Node Address	1
Enable/Disable Settings	Enabled
Serial Number	0x00000000
PDO Map Settings	
0x7000:01	1st receive PDO...
0x7010:01	2nd receive PDO...
0x7020:01	3rd receive PDO...
0x7030:01	4th receive PDO...
0x7040:01	5th receive PDO...
0x7050:01	6th receive PDO...
0x7060:01	7th receive PDO...
0x7070:01	8th receive PDO...
0x3000:01	257th transmit P...
0x3001:01	258th transmit P...
0x3002:01	259th transmit P...
0x3003:01	260th transmit P...
0x3004:01	261th transmit P...
0x6000:01	1st transmit PD...
0x6010:01	2nd transmit PD...
0x6020:01	3rd transmit PD...
0x6030:01	4th transmit PD...
0x6040:01	5th transmit PD...
0x6050:01	6th transmit PD...
0x6060:01	7th transmit PD...
0x6070:01	8th transmit PD...
0x10F3:04	511th transmit P...
0x2002:01	512th transmit P...

Enable Distributed Clock: Disabled (FreeRun)

Edit PDO Map Settings

7.5. Controller Setup

Set up Controller.

7.5.1. Setting the Device Variables

Set the device variables to use for IO-Link Master Unit.

- 1 Double-click **I/O Map** under **Configurations and Setup** in the Multiview Explorer.

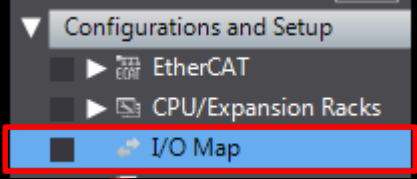

- 2 The I/O Map Tab Page is displayed in the Edit Pane. Check that Node1 is displayed in the *Position* Column and that the added IO-Link Master Unit is displayed in the *Port* Column.

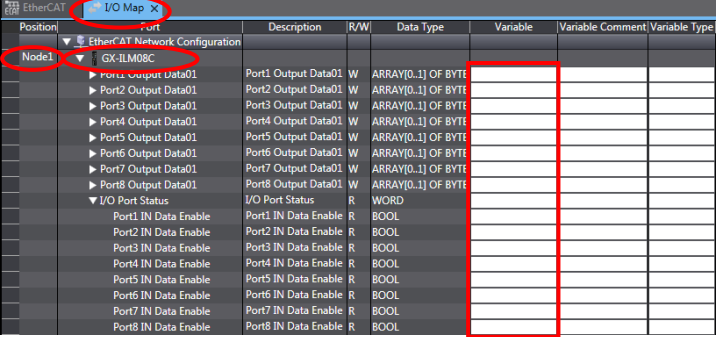
*To manually set a variable name for IO-Link Master Unit, click an entry cell in the *Variable* Column and enter a name.

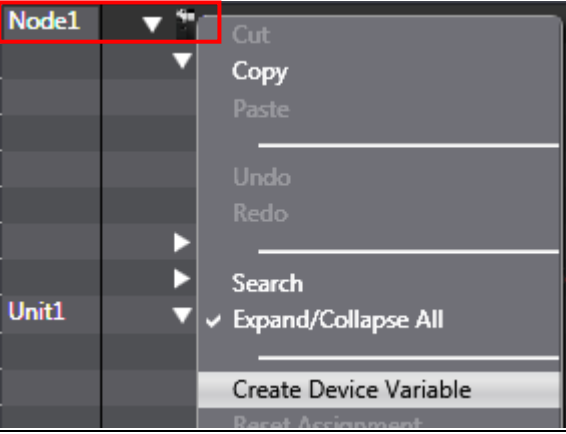

Position	Port	Description	R/W	Data Type	Variable	Variable Comment	Variable Type
Node1	GX-ILM08C						
	Port1 Output Data01	Port1 Output Data01	W	ARRAY[0..1] OF BYTE			
	Port2 Output Data01	Port2 Output Data01	W	ARRAY[0..1] OF BYTE			
	Port3 Output Data01	Port3 Output Data01	W	ARRAY[0..1] OF BYTE			
	Port4 Output Data01	Port4 Output Data01	W	ARRAY[0..1] OF BYTE			
	Port5 Output Data01	Port5 Output Data01	W	ARRAY[0..1] OF BYTE			
	Port6 Output Data01	Port6 Output Data01	W	ARRAY[0..1] OF BYTE			
	Port7 Output Data01	Port7 Output Data01	W	ARRAY[0..1] OF BYTE			
	Port8 Output Data01	Port8 Output Data01	W	ARRAY[0..1] OF BYTE			
	I/O Port Status	I/O Port Status	R	WORD			
	Port1 IN Data Enable	Port1 IN Data Enable	R	BOOL			
	Port2 IN Data Enable	Port2 IN Data Enable	R	BOOL			
	Port3 IN Data Enable	Port3 IN Data Enable	R	BOOL			
	Port4 IN Data Enable	Port4 IN Data Enable	R	BOOL			
	Port5 IN Data Enable	Port5 IN Data Enable	R	BOOL			
	Port6 IN Data Enable	Port6 IN Data Enable	R	BOOL			
	Port7 IN Data Enable	Port7 IN Data Enable	R	BOOL			
	Port8 IN Data Enable	Port8 IN Data Enable	R	BOOL			
- 3 Right-click **Node1** and select **Create Device Variable**.

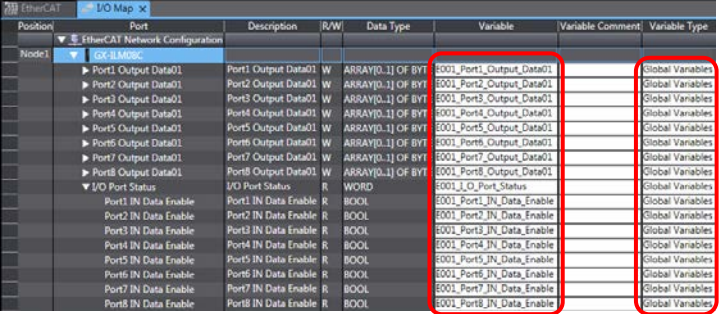
- 4 The variable names and types are set.



Position	Port	Description	R/W	Data Type	Variable	Variable Comment	Variable Type
Node1	GX-ILM08C						
	Port1 Output Data01	Port1 Output Data01	W	ARRAY[0..1] OF BYT	E001_Port1_Output_Data01		Global Variables
	Port2 Output Data01	Port2 Output Data01	W	ARRAY[0..1] OF BYT	E001_Port2_Output_Data01		Global Variables
	Port3 Output Data01	Port3 Output Data01	W	ARRAY[0..1] OF BYT	E001_Port3_Output_Data01		Global Variables
	Port4 Output Data01	Port4 Output Data01	W	ARRAY[0..1] OF BYT	E001_Port4_Output_Data01		Global Variables
	Port5 Output Data01	Port5 Output Data01	W	ARRAY[0..1] OF BYT	E001_Port5_Output_Data01		Global Variables
	Port6 Output Data01	Port6 Output Data01	W	ARRAY[0..1] OF BYT	E001_Port6_Output_Data01		Global Variables
	Port7 Output Data01	Port7 Output Data01	W	ARRAY[0..1] OF BYT	E001_Port7_Output_Data01		Global Variables
	Port8 Output Data01	Port8 Output Data01	W	ARRAY[0..1] OF BYT	E001_Port8_Output_Data01		Global Variables
	I/O Port Status	I/O Port Status	R	WORD	E001_I_O_Port_Status		Global Variables
	Port1 IN Data Enable	Port1 IN Data Enable	R	BOOL	E001_Port1_IN_Data_Enable		Global Variables
	Port2 IN Data Enable	Port2 IN Data Enable	R	BOOL	E001_Port2_IN_Data_Enable		Global Variables
	Port3 IN Data Enable	Port3 IN Data Enable	R	BOOL	E001_Port3_IN_Data_Enable		Global Variables
	Port4 IN Data Enable	Port4 IN Data Enable	R	BOOL	E001_Port4_IN_Data_Enable		Global Variables
	Port5 IN Data Enable	Port5 IN Data Enable	R	BOOL	E001_Port5_IN_Data_Enable		Global Variables
	Port6 IN Data Enable	Port6 IN Data Enable	R	BOOL	E001_Port6_IN_Data_Enable		Global Variables
	Port7 IN Data Enable	Port7 IN Data Enable	R	BOOL	E001_Port7_IN_Data_Enable		Global Variables
	Port8 IN Data Enable	Port8 IN Data Enable	R	BOOL	E001_Port8_IN_Data_Enable		Global Variables



Additional Information

The device variables are named automatically from a combination of the device names and the port names.

The default device names are "E" followed by a serial number that starts from 001.



Additional Information

In this document, device variables are automatically named for a unit (a slave).

Device variables can also be manually named for ports.

7.5.2. Transferring the Project Data

Connect online with Sysmac Studio and transfer the project data to Controller.

⚠ WARNING

When you transfer a user program, configuration data, setup data, device variables, or values in memory used for CJ-series Units from Sysmac Studio, the devices or machines may perform unexpected operation regardless of the operating mode of CPU Unit.

Always confirm safety at the destination node before you transfer the project data.



⚠ Caution

After you transfer the project data, CPU Unit restarts, and communications with the slave unit is cut off. During the period, the slave unit outputs behave according to the slave unit settings. The time that communications is cut off depends on the EtherCAT network configuration.

Before you transfer the project data, confirm that the slave unit settings will not adversely affect the device.



⚠ Caution

The slave unit will be reset after performing the synchronization in step 7 and subsequent steps, and the device may perform unexpected operation.

Always confirm safety before you perform the synchronization.

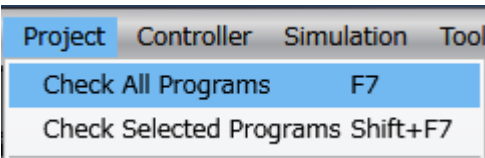
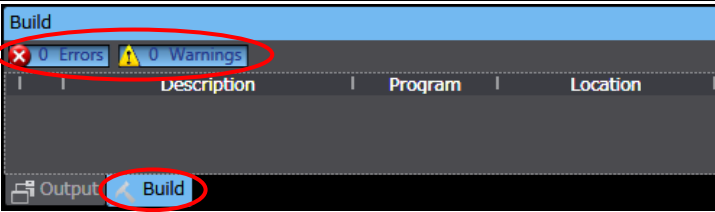
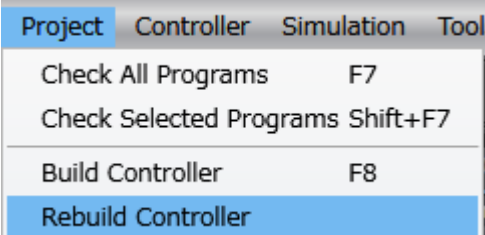

1	Select Check All Programs from the Project Menu.	
2	The Build Tab Page is displayed. Check that "0 Errors" and "0 Warnings" are displayed.	
3	Select Rebuild Controller from the Project Menu.	

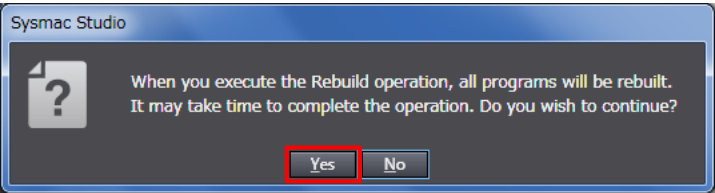
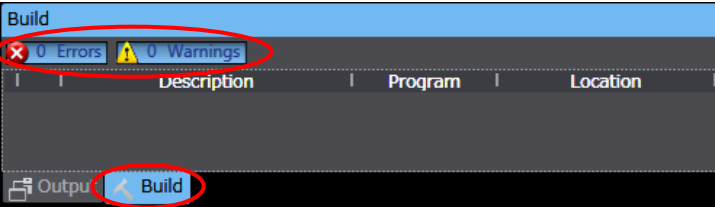
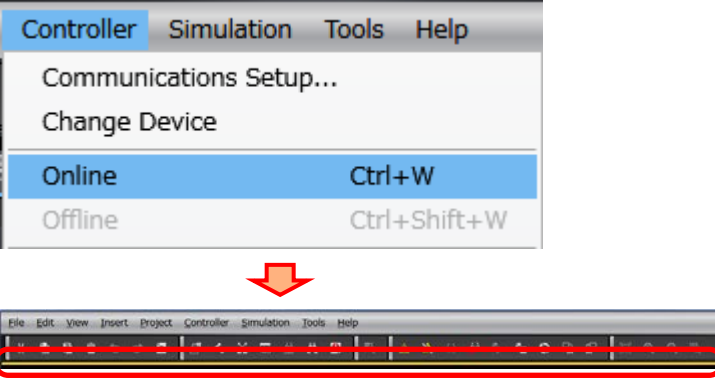
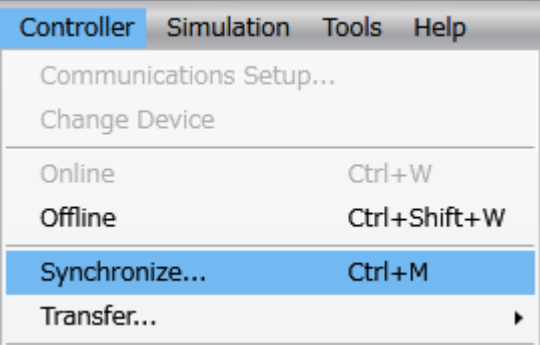
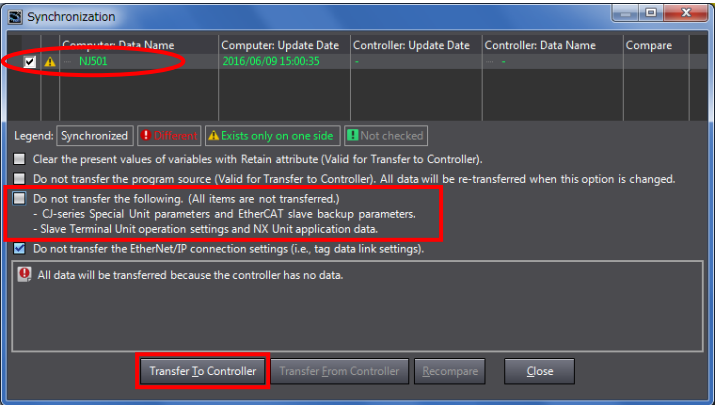
<p>4 The dialog box on the right is displayed. Confirm that there is no problem, and click Yes.</p>	
<p>5 Check that "0 Errors" and "0 Warnings" are displayed on the Build Tab Page.</p>	
<p>6 Select Online from the Controller Menu.</p> <p>When an online connection is established, a yellow bar is displayed under the toolbar.</p>	
<p>7 Select Synchronize from the Controller Menu.</p>	
<p>8 The Synchronization Dialog Box is displayed.</p> <p>Check that the data to transfer (NJ501 in the right dialog box) is selected.</p> <p>Uncheck <i>Do not transfer the following</i>. (All items are not transferred.) to make "Slave Terminal Unit operation settings" transfer.</p> <p>Click Transfer To Controller.</p> <p>*After executing Transfer To Controller, the Sysmac Studio data is transferred to Controller, and the data is synchronized.</p>	

9 The dialog box on the right is displayed. Confirm that there is no problem, and click **Yes**.

A screen is displayed stating "Synchronizing".

The dialog box on the right is displayed. Confirm that there is no problem, and click **No**.

*Do not return to RUN mode.

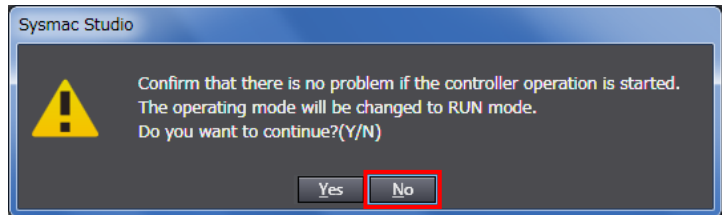
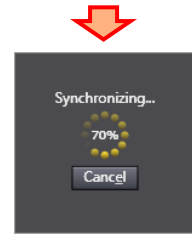
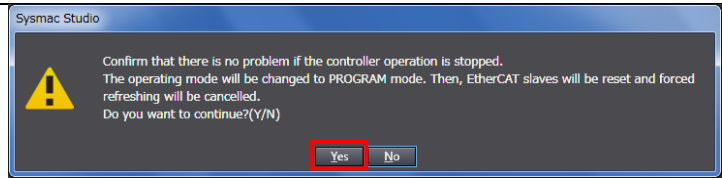

10 As shown in the figure on the right, the font color that is used to display the text of synchronized data changes to the same color as the one used to specify "Synchronized". Check that a message is displayed stating "Cycle the power supply to the slave(s) to apply the settings". Click **Close**.

*When the Sysmac Studio project data coincides with the Controller data, the synchronized data will have the same font color as the one used to specify "Synchronized".

*If the synchronization fails, check the wiring and repeat from step 1.

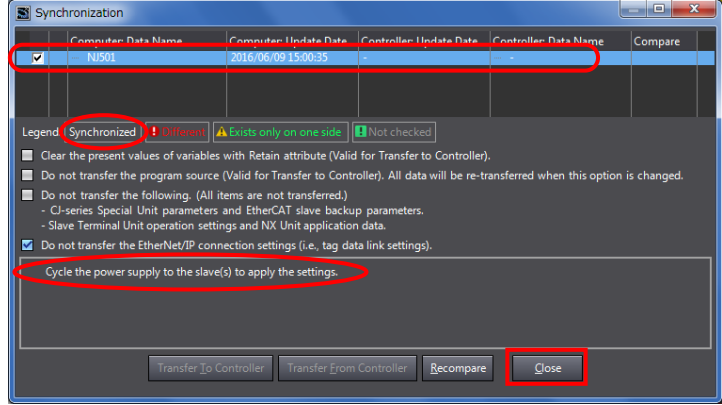

11 To reflect the settings, turn OFF Unit power supply for IO-Link Master Unit, then turn it back ON.

12 Check that the LED status is as shown below, which indicates that IO-Link Master Unit is able to communicate.

- RUN : Not lit
- ERR : Not lit
- L/A IN : Green flickering
- L/A OUT: Not lit

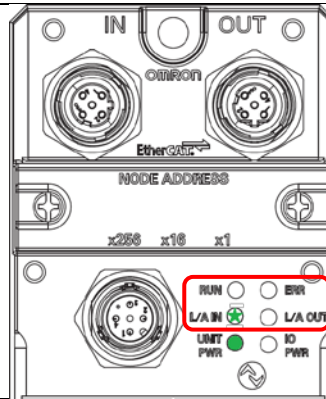

13 The LED status of Controller is as shown below when an error occurs in EtherCAT communications due to the temporary interruption of Unit power supply for IO-Link Master Unit.

- NET RUN : Not lit
- NET ERR : Red flashing
- LINK/ACT : Yellow flashing

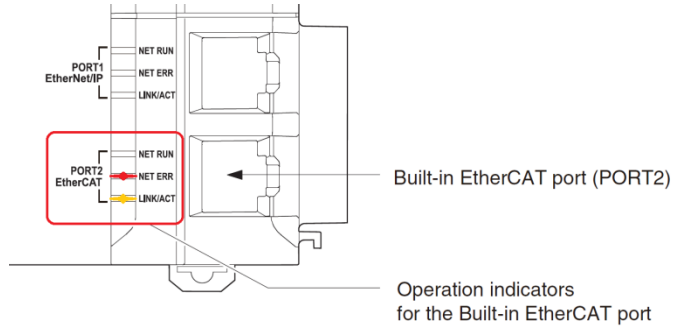

14 Select **Troubleshooting** from the Tools Menu.

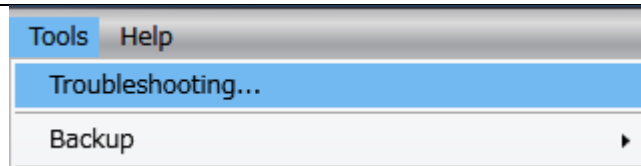

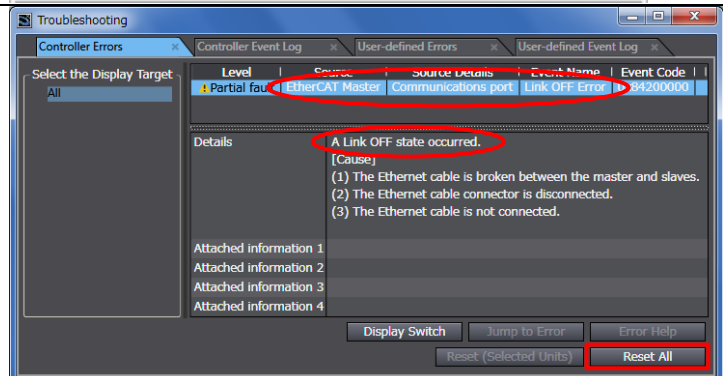

15 The Troubleshooting Dialog Box is displayed. Check that a Link OFF Error occurs as shown in the figure on the right.

Click **Reset All**.

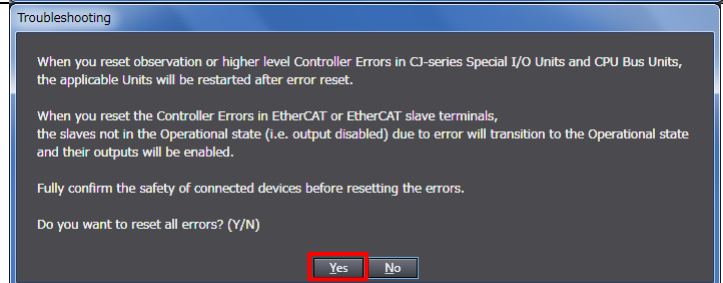

16 The dialog box on the right is displayed. Check the contents and click **Yes**.



- 17 Check that the error is not displayed. Click  at the top right of the Troubleshooting Dialog Box to close.

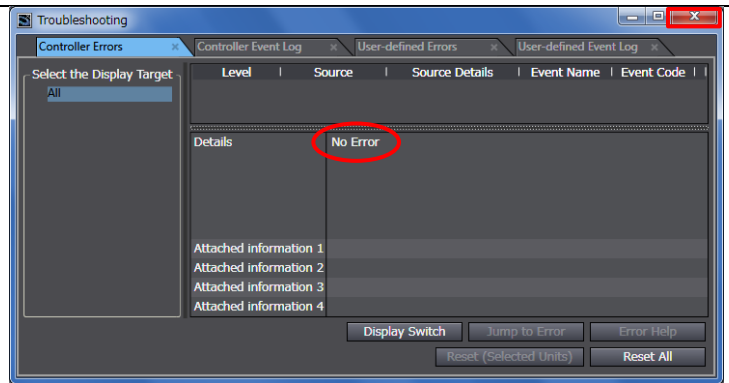

- 18 Turn ON I/O power supply for IO-Link Master Unit.

7.6. IO-Link Communication Status Check

Confirm that cyclic communications in the IO-Link system performs normally.

7.6.1. Checking the Connection Status

Check the connection status of each device.

- 1 Check with LED indicators on Controller that PDO communications via EtherCAT performs normally.

The LED indicators in normal status are as follows:
 NET RUN: Green lit
 NET ERR: Not lit
 LINK/ACT: Yellow flashing

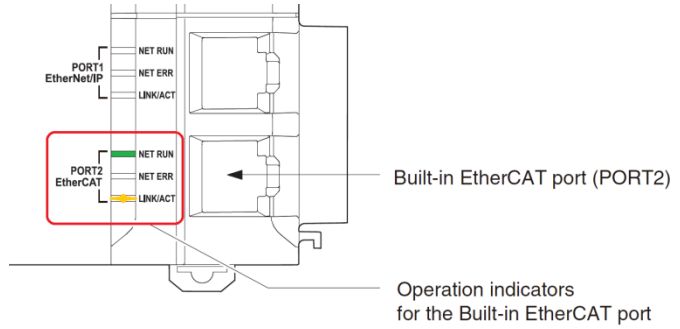

- 2 Check the LED indicators on IO-Link Master Unit.

The LED indicators in normal status are as follows:
 RUN: Green lit
 ERR: Not lit
 L/A IN: Green flickering
 L/A OUT: Not lit

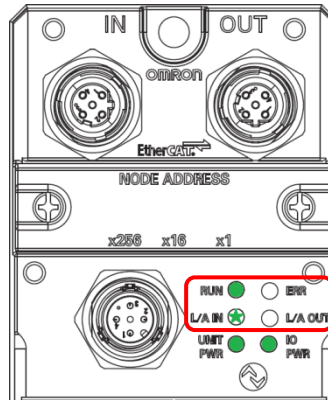

- 3 Check the I/O indicator for Port 1 on IO-Link Master Unit.

The I/O indicator in normal status is as follows:
 A: Green lit

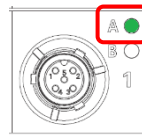

- 4 Check the LED indicator on Proximity Sensor.

The LED indicator in normal status is as follows:
 Stability indicator /
 Communication indicator:
 Green blinking
 (1sec cycle)

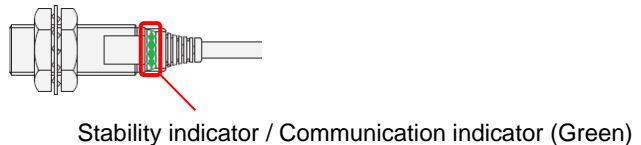

7.6.2. Checking the Receive Data

Check that the correct data are received.

Check that CX-ConfiguratorFDT is being installed on Personal computer.

CX-ConfiguratorFDT is included in Sysmac Studio.

⚠ Caution

If you wire the I/O in the state where the devices are powered ON, doing so may cause damage to the devices.

Always read and follow the information provided in all safety precautions in the manuals for each device to be wired.



⚠ Caution

If you change the variable values on a Watch Tab Page when Sysmac Studio is online with CPU Unit, the devices connected to the output unit may operate regardless of the operating mode of CPU Unit.

Always ensure safety before you change the variable values on a Watch Tab Page when Sysmac Studio is online with CPU Unit



- 1 Select **Watch Tab Page** from the View Menu.

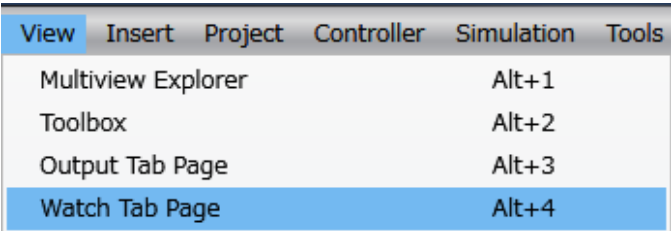

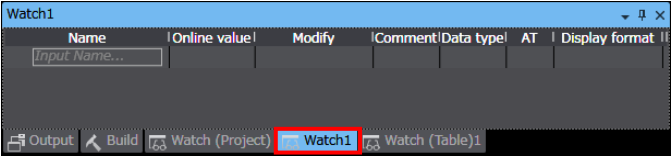
- 2 Select the **Watch1** Tab.

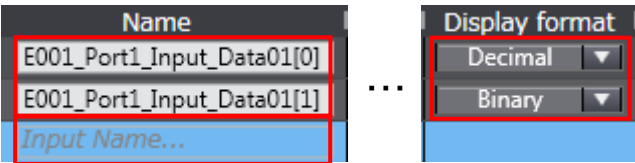

- 3 Click *Input Name* and enter the following variable names for monitoring. Select the display format of each variable as shown below.

<p>Name:</p> <p style="padding-left: 20px;"><i>E001_Port1_Input_Data01[0]</i></p> <p style="padding-left: 40px;">Display format: Decimal</p> <p>Name:</p> <p style="padding-left: 20px;"><i>E001_Port1_Input_Data01[1]</i></p> <p style="padding-left: 40px;">Display format: Binary</p>	
--	--

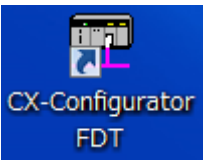
- 4 Start CX-ConfiguratorFDT.

*Click **Yes** if a dialog box to update the device catalog is displayed when starting CX-ConfiguratorFDT.

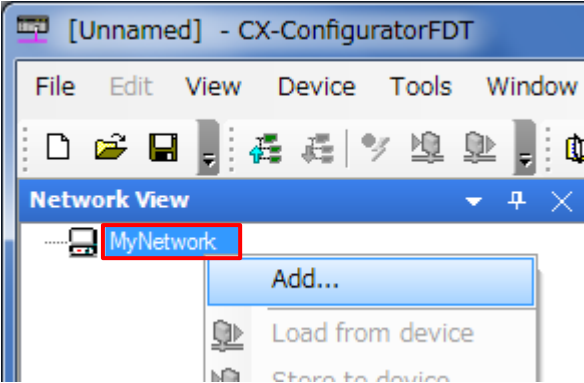
- 5 CX-ConfiguratorFDT starts. Right-click **MyNetwork** in the Network View and select **Add** from the menu.

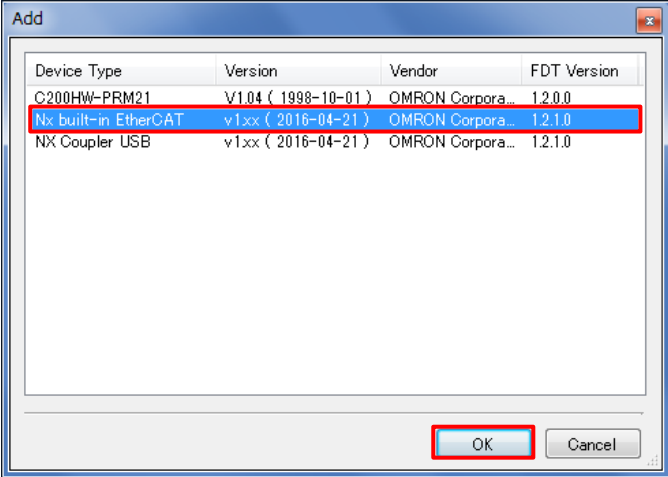

- 6 The Add Dialog Box is displayed. Select **Nx built-in EtherCAT**. Click **OK**.

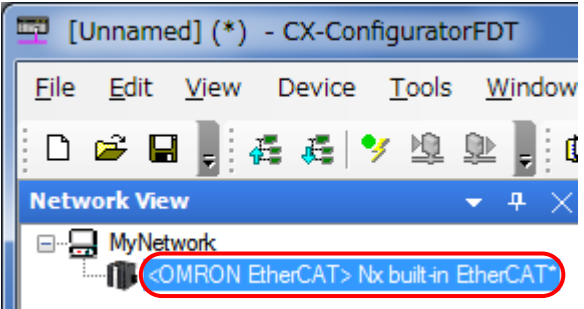

Device Type	Version	Vendor	FDT Version
C200HW-PRM21	V1.04 (1998-10-01)	OMRON Corpora...	12.0.0
Nx built-in EtherCAT	v1xx (2016-04-21)	OMRON Corpora...	12.1.0
NX Coupler USB	v1xx (2016-04-21)	OMRON Corpora...	12.1.0
- 7 Check that <OMRON EtherCAT> Nx built-in EtherCAT is added under MyNetwork in the Network View.

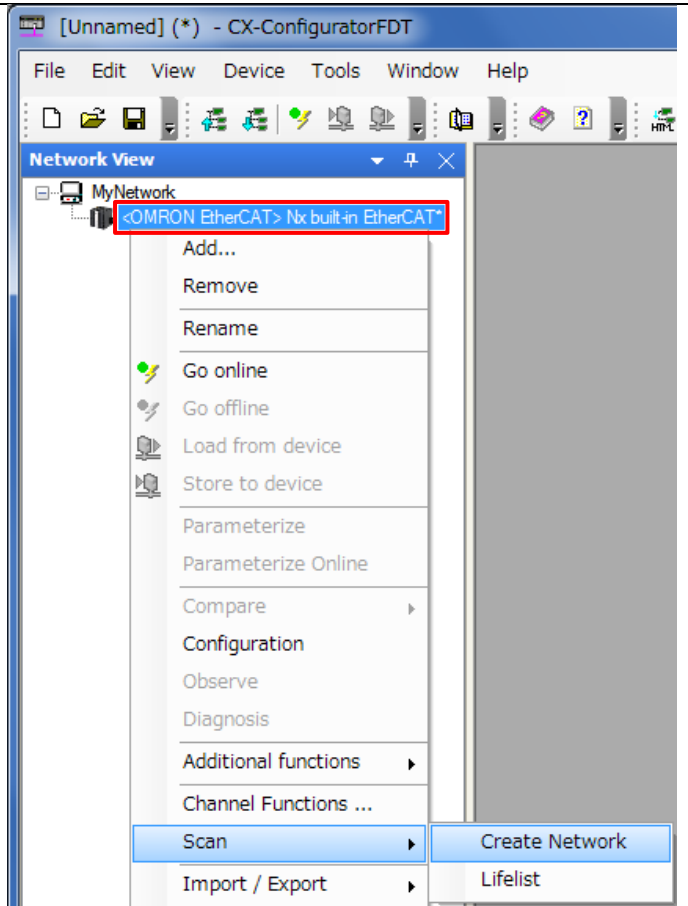

- 8 Right-click <OMRON EtherCAT> Nx built-in EtherCAT and select **Scan - Create Network** from the menu.



- 9 The Lifelist Dialog Box is displayed after completing the network scan. Check that <OMRON EtherCAT:1> GX-ILM08C is added under Nx built-in EtherCAT. Click **Add All and Continue**.

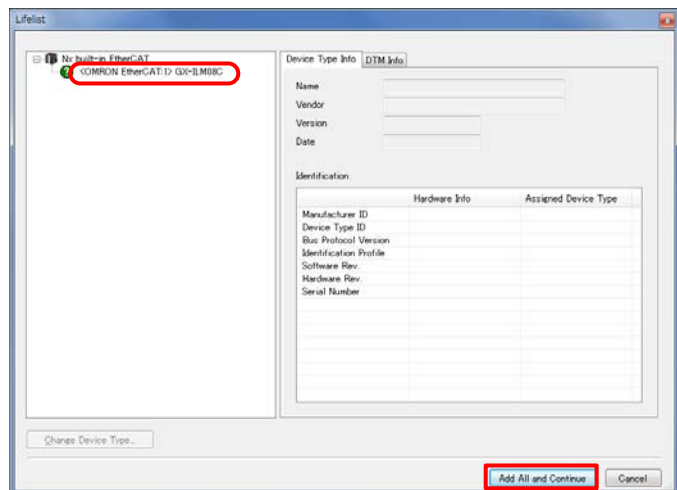
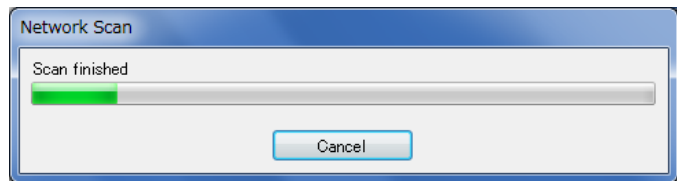

- 10 The Lifestlist Dialog Box is displayed again after completing the network scan.
 Check that <IO-Link Port_1:NOT_APPLICABLE> E2E-X3B4-IL3 IODD1.1 is added under GX-ILM08C.
 Click **Add All and Continue**.

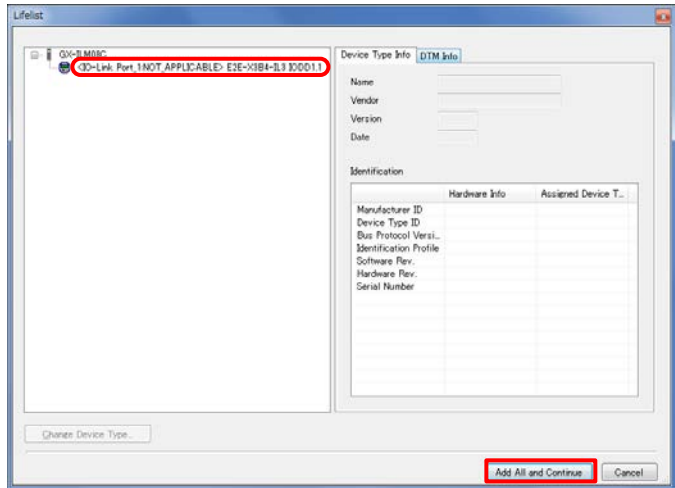
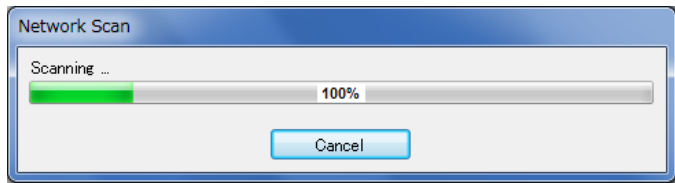

- 11 Check that the network configuration is created in the Network View as shown on the right.

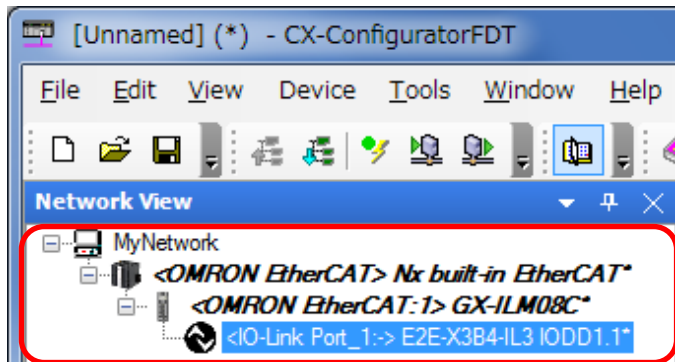

- 12 Right-click <IO-Link Port_1-> E2E-X3B4-IL3 IODD1.1 and select **Go online** from the menu.

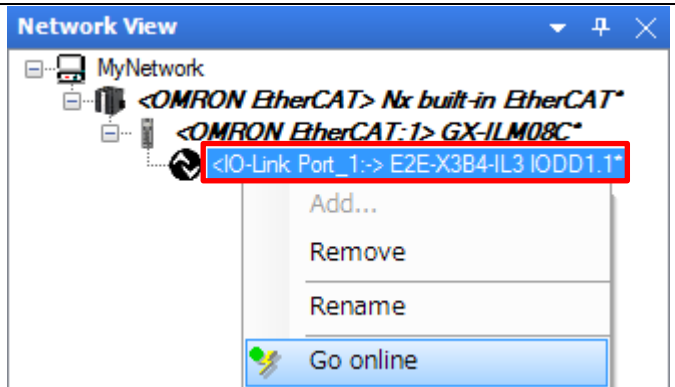

- 13 Check that Proximity Sensor is connected online.
 Right-click <IO-Link Port_1:-> E2E-X3B4-IL3 IODD1.1 and select **Configuration** from the menu.

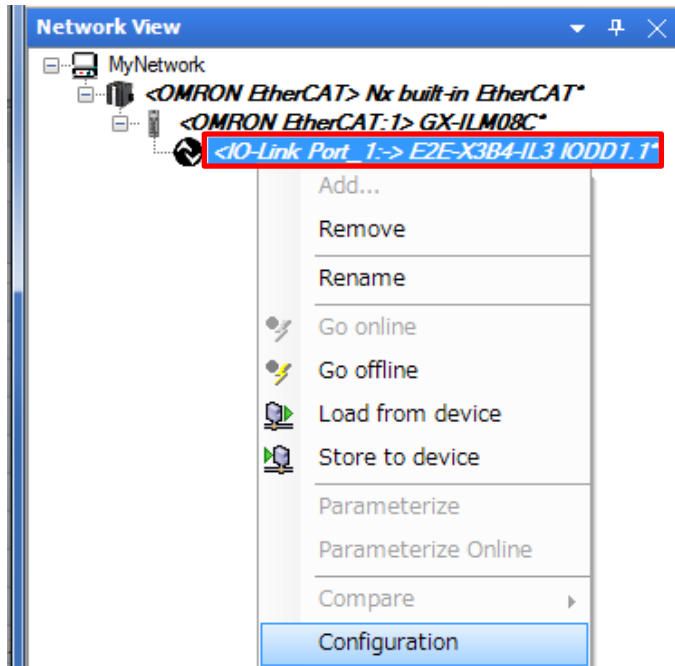

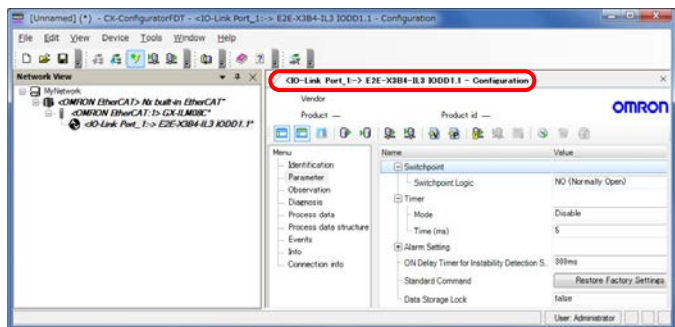

*When <IO-Link Port_1:-> E2E-X3B4-IL3 IODD1.1 is displayed in bold italic font, Proximity Sensor is connected online.

- 14 The <IO-Link Port_1:-> E2E-X3B4-IL3 IODD1.1 - Configuration Tab Page is displayed.

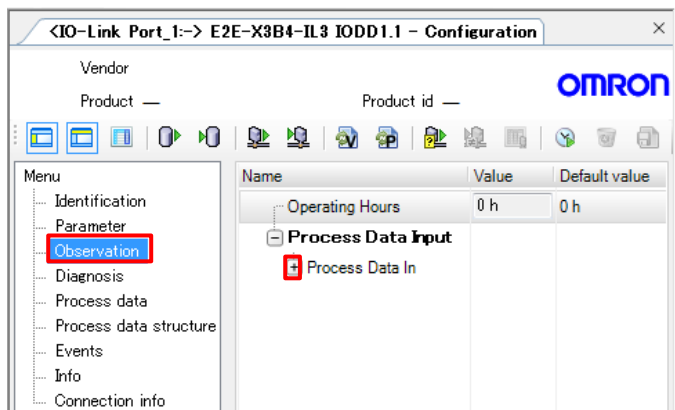

- 15 Select **Observation** listed under Menu on the <IO-Link Port_1:-> E2E-X3B4-IL3 IODD1.1 - Configuration Tab Page.
 If Process Data In on the right side of the tab page is not expanded, click the + Button of Process Data In to expand.



- 16 Click the  icon (Enable or disable cyclic read from device for dynamic variables) on the <IO-Link Port_1:-> E2E-X3B4-IL3 IODD1.1 - Configuration Tab Page.
 The present values of the process data for Proximity Sensor are displayed in the *Value* Column.

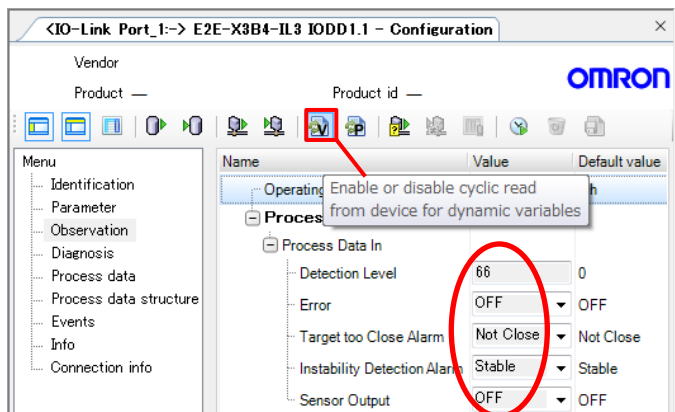

17 Make sure that there is no sensing object in front of Proximity Sensor and that Operation indicator is not lit.

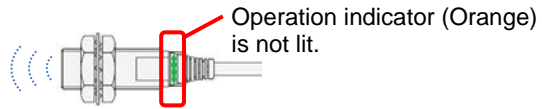

18 Check that the values of proximity Sensor in CX-ConfiguratorFDT are as shown below.

Detection Level: 66
Sensor Output: OFF

*The value of the detection level differs depending on the environmental settings of Proximity Sensor.

Name	Value	Default value
Operating Hours	0 h	0 h
Process Data Input		
Process Data In		
Detection Level	66	0
Error	OFF	OFF
Target too Close Alarm	Not Close	Not Close
Instability Detection Alarm	Stable	Stable
Sensor Output	OFF	OFF

19 Check that the online values on the Watch Tab Page of Sysmac Studio are as shown below.

E001_Port1_Input_Data01[0]
: 66
E001_Port1_Input_Data01[1]
: 0000 0000 (Bit 0 is 0.)

Name	Online value
<i>E001_Port1_Input_Data01[0]</i>	66
<i>E001_Port1_Input_Data01[1]</i>	0000 0000

*For details on each of the variables, refer to 6.3. *Device Variables*.

*You can check that the monitor output (Detection Level) of Port 1 is 66 and that the control output (Sensor Output) is OFF; these values are the same as the ones described in step 18.

20 Place Sensing object in front of Proximity Sensor and check that Operation indicator is lit in orange.

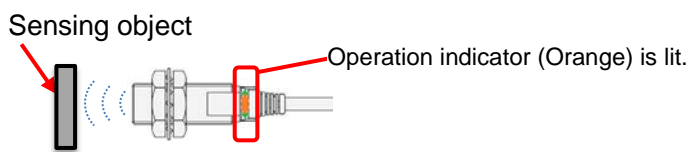

21 Check that the values of Proximity Sensor in CX-ConfiguratorFDT are as shown below.

Detection Level: 137

Sensor Output: ON

*The value of the detection level differs depending on the environmental settings of Proximity Sensor.

Name	Value	Default value
Operating Hours	0 h	0 h
Process Data Input		
Process Data In		
Detection Level	137	0
Error	OFF	OFF
Target too Close Alarm	Not Close	Not Close
Instability Detection Alarm	Stable	Stable
Sensor Output	ON	OFF

22 Check that the online values on the Watch Tab Page of Sysmac Studio are as shown below.

E001_Port1_Input_Data01[0]

: 137

E001_Port1_Input_Data01[1]

: 0000 0011 (Bit 0 is 1.)

Name	Online value
<i>E001_Port1_Input_Data01[0]</i>	137
<i>E001_Port1_Input_Data01[1]</i>	0000 0001

*For details on each of the variables, refer to 6.3. *Device Variables*.

*You can check that the monitor output (Detection Level) of Port 1 is 137 and that the control output (Sensor Output) is ON; these values are the same as the ones described in step 21.

8. Initialization method

The setting procedures in this document are based on the factory default settings. Some settings may not be applicable unless you use the devices with the factory default settings.

8.1. Initializing Controller

To initialize the Controller settings, it is necessary to initialize CPU Unit.

Change the operating mode of Controller to PROGRAM mode and select **Clear All Memory** from the Controller Menu in Sysmac Studio. The Clear All Memory Dialog Box is displayed.

Check the contents and click **OK**.

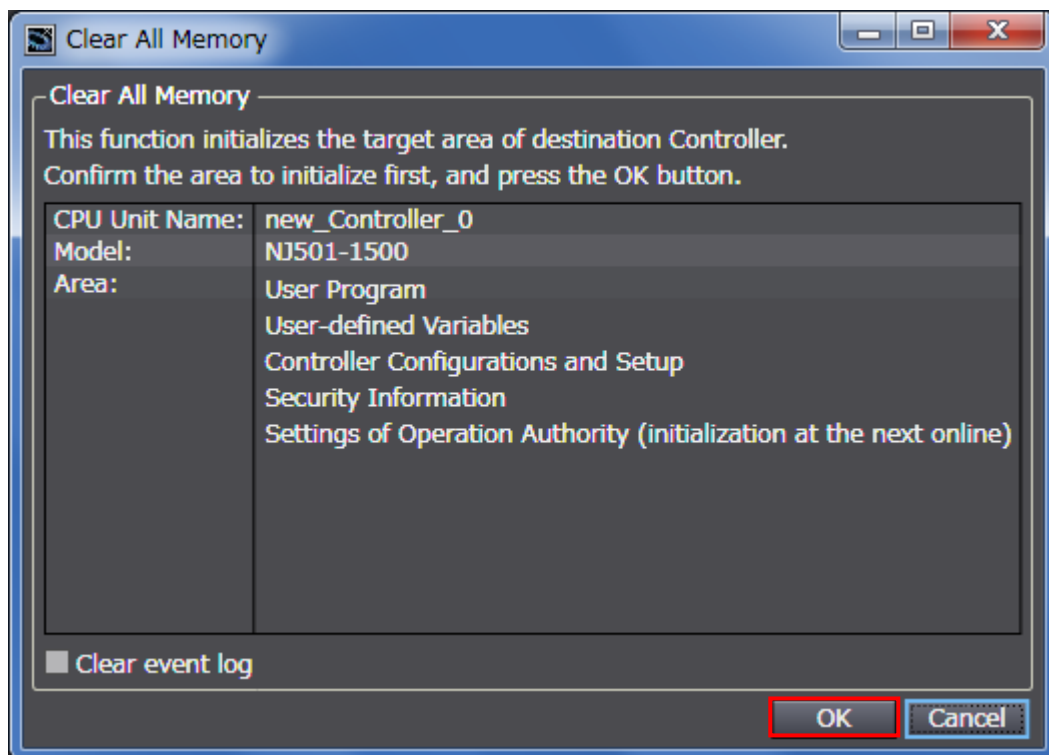

8.2. Initializing IO-Link Master Unit

To initialize the IO-Link Master Unit settings, display the tab page in step 2 of 7.4.1. *Parameter Settings* of this document, and connect Sysmac Studio online with Controller.

By clicking **Return to Default**, all the parameters of IO-Link Master Unit are restored to the factory default settings.

Click **Transfer to Slave**.

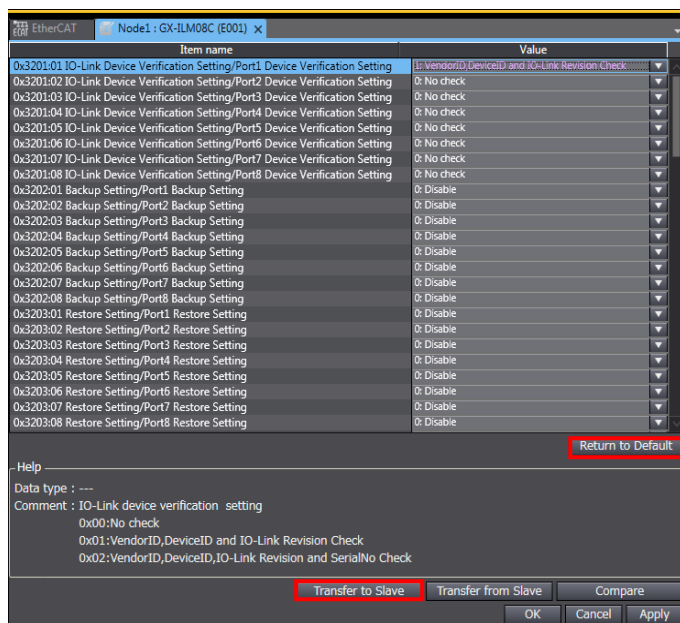

Precautions for Correct Use

In the initialization of IO-Link Master Unit, the backup data for the IO-Link devices that is stored in IO-Link Master Unit is not cleared. If you need to clear the backup data stored in IO-Link Master Unit, refer to *Clearing Backup Data* in 7-4-2 *Backing Up Settings* of the *IO-Link System User's Manual* (Cat. No. W570) to clear the backup data.

8.3. Initializing Proximity Sensor

To initialize Proximity Sensor, execute System-Command to "Restore factory settings". For details, refer to 4. *Service data* of the *PROXIMITY SENSOR INDEX LIST* (Cat. No. 9540292-0).

9. Revision History

Revision code	Date of revision	Description of revision
01	August 23, 2016	First edition

OMRON Corporation Industrial Automation Company

Tokyo, JAPAN

Contact: www.ia.omron.com

Regional Headquarters

OMRON EUROPE B.V.

Wegalaan 67-69, 2132 JD Hoofddorp
The Netherlands

Tel: (31)2356-81-300/Fax: (31)2356-81-388

OMRON ELECTRONICS LLC

2895 Greenspoint Parkway, Suite 200
Hoffman Estates, IL 60169 U.S.A

Tel: (1) 847-843-7900/Fax: (1) 847-843-7787

OMRON ASIA PACIFIC PTE. LTD.

No. 438A Alexandra Road # 05-05/08 (Lobby 2),
Alexandra Technopark,
Singapore 119967

Tel: (65) 6835-3011/Fax: (65) 6835-2711

OMRON (CHINA) CO., LTD.

Room 2211, Bank of China Tower,
200 Yin Cheng Zhong Road,
PuDong New Area, Shanghai, 200120, China

Tel: (86) 21-5037-2222/Fax: (86) 21-5037-2200

Authorized Distributor:

© OMRON Corporation 2016 All Rights Reserved.
In the interest of product improvement,
specifications are subject to change without notice.

Cat. No. P667-E1-01

0816-(-)