

FA Communications Software

CX-Compolet / SYSMAC Gateway

Flexible & High Speed PLC-Accessing Softwares

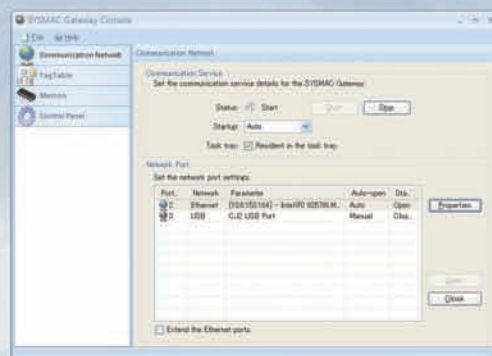

» High Speed

» Direct Data link Access

» Flexible

OMRON's FA Communications Software High-speed, and Direct Data Link Access

The need for faster transmission of more and more information between personal computers and PLCs is coupled with the need for frequent changes to specifications, such as address allocations in PLCs, a demand for software standardization to eliminate dependence on specific applications and networks, and a demand for cost reductions.

OMRON provides the functions to solve these problems. Data links are now possible using Ethernet. Data links can even be accessed via a LAN port on a notebook computer. And FA Communications Software can be used to access PLC data by using only tag names to enable more flexible and higher-speed access of PLC data from personal computers, and that lowers costs by eliminating the need for a special board for data links.

Windows 11 (64bit version*) / Visual Studio 2022 supported

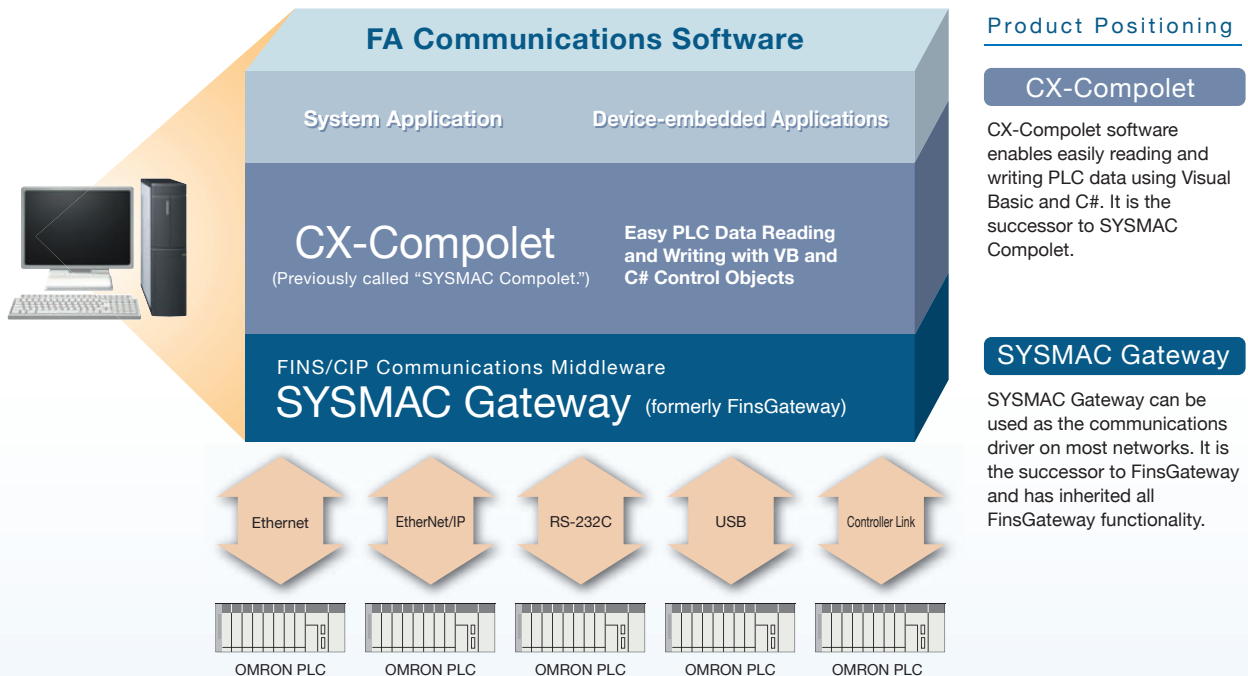

* This software runs on WOW64 (Windows-On-Windows 64). Refer to the sample program included with the product to run applications as 64-bit processes.

Sysmac is a trademark or registered trademark of OMRON Corporation in Japan and other countries for OMRON factory automation products.

Microsoft, Visual Basic, Visual Studio, ActiveX and Windows are either registered trademarks or trademarks of Microsoft Corporation in the United States and/or other countries.

Microsoft product screen shots reprinted with permission from Microsoft Corporation.

iPhone and iPad are registered trademarks of Apple Inc.

Other company names and product names in this document are the trademarks or registered trademarks of their respective companies.

Lets You Create Applications with Flexible, to PLCs from Personal Computers.

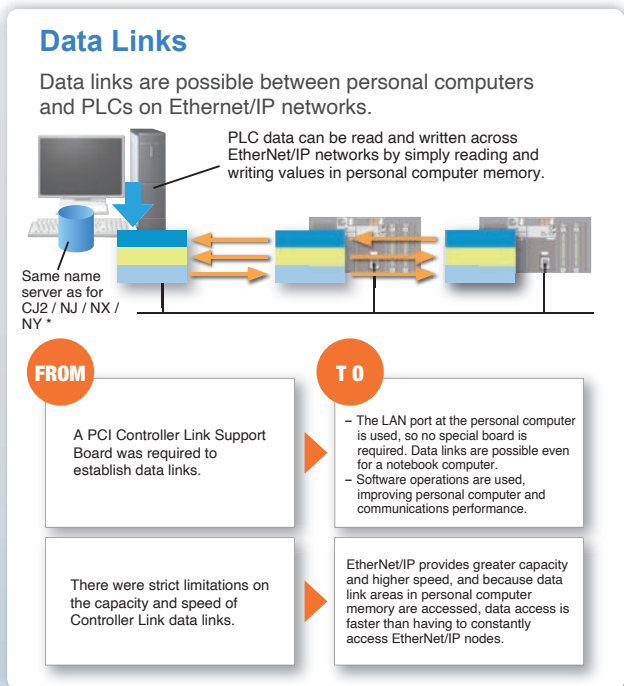
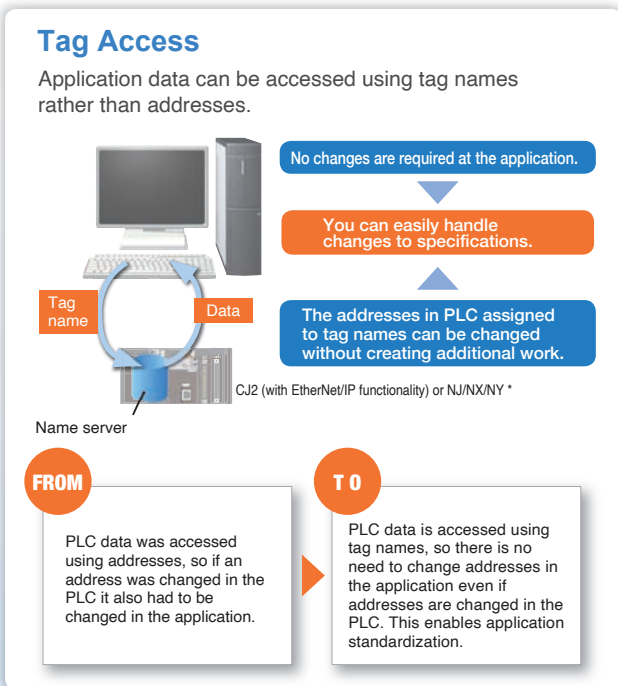
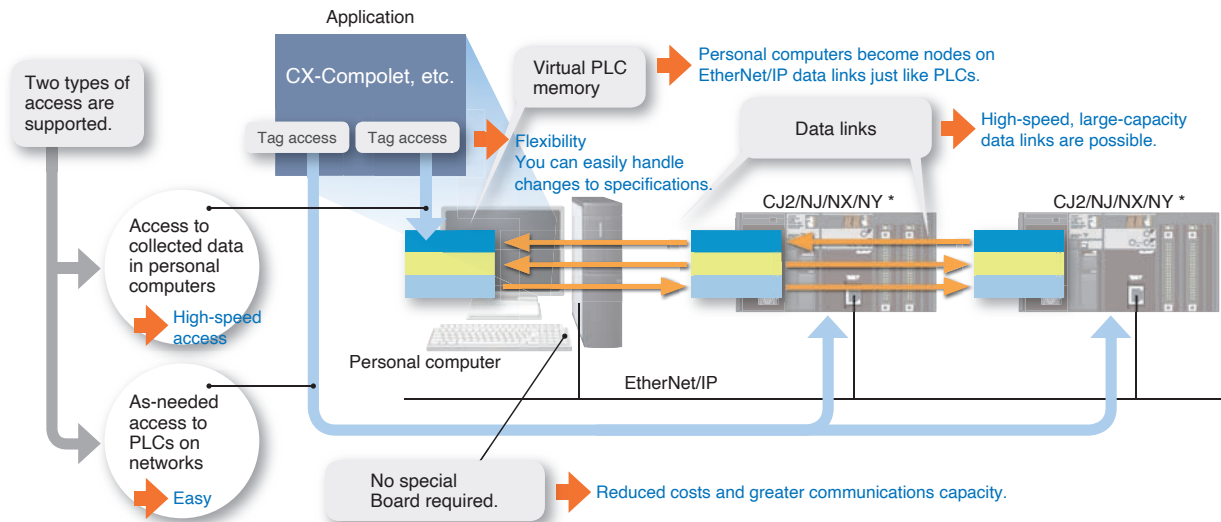
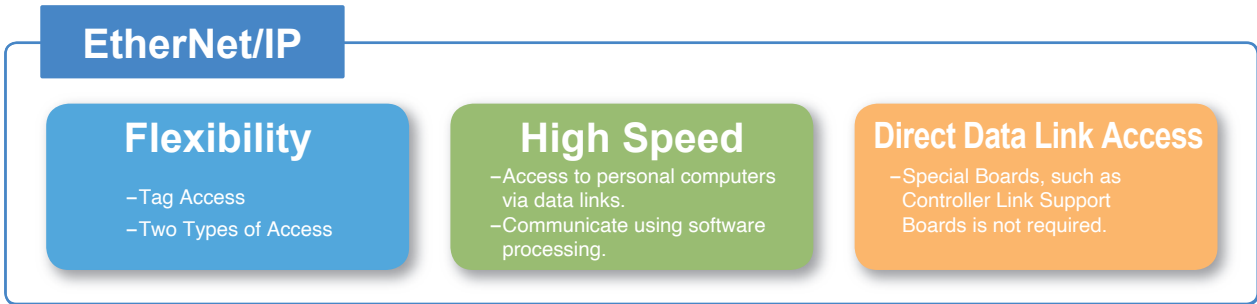

Note: The Network Configurator included in the CX-One Package or Sysmac Studio is required to set tag data links. Tag access is available with CJ2-series and NJ/NX-series CPU Units, NY-series Industrial PC with EtherNet/IP functionality. But, the tag data link with internal port of NY series is impossible.
 * NY-series is only Industrial PC Platform NY-series IPC Machine Controller.

Easily Create Programming to Read and Write PLC Data using VB or C#.

CX-Compolet

.NET Control Objects ActiveX Control Objects are also included.

CX-Compolet is a package of software components that make it easy to program reading and writing OMRON PLC data.

- Read and write I/O memory in the PLC, change the operating mode, read error logs, and perform other operations.
- Supports Microsoft Visual Studio 2012/2013/2015/2017/2019/2022.
- For the CJ2 (with EtherNet/IP functionality) or NJ/NX/NY, I/O memory in the PLC can be accessed by using tag names rather than addresses.
- Array and structure variable access is possible.
- Read and write variables corresponding to the data types of CIP that conform to ODVA specifications.

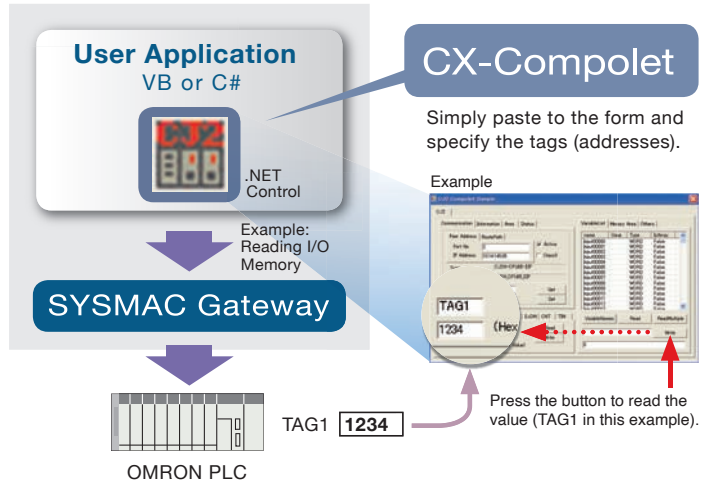

Situation → Creating and Modifying VB/C# Communications Programming Is Too Much Work

Problem		Solution	
Customers who are developing VB/C# applications including communications with PLCs	Having to program communications frame assembly, reception response interpretation, and monitoring is too much work.	▶	Processing such as communications frame assembly is prepared in advance.
	Having to change communications processing, e.g., for Ethernet and serial communications, is too much work.	▶	Data is accessed by using tag names rather than by using addresses, so programming does not have to be changed even if PLC addresses are changed. *
	Handling PLC address changes is particularly time consuming.	▶	Array variables are supported, so data can be easily specified by simply changing the element subscript with the same tag name. *
	For a block of data of the same data type, it is too much work to have to specify the addresses one by one rather than being able to view them as one group and access that data as an element.	▶	

* When combined with the CJ2 (with EtherNet/IP functionality) or NJ/NX/NY.

Procedure

Simply Paste to a Form and Enter a Line of Code.

- 1 After installation, the NJ Compolet Icon will be displayed in the controls.
 - 2 Position the NJ Compolet Icon in the form.
 - 3 Arrange the command buttons, text boxes, etc. in the form.
 - 4 Set the remote PLC in the properties.
 - 5 In the Command Button Code Dialog Box, enter the PLC tag name on one line. (The tag name below is "PV.")
- Code Example: `Text1=NJ Compolet1.ReadVariable "PV"`

Application Example

Easily Program Device Alarm Monitoring.

- Using the control components provided by CX-Compolet frees the application designers from having to program the communications portions of the application.
- Data for device alarms and other data are sent to the applications using non-solicited EtherNet/IP communications events.
- Standardization is made easy by specifying data using tag names (such as "Alarm A" and "Alarm B") in the applications.

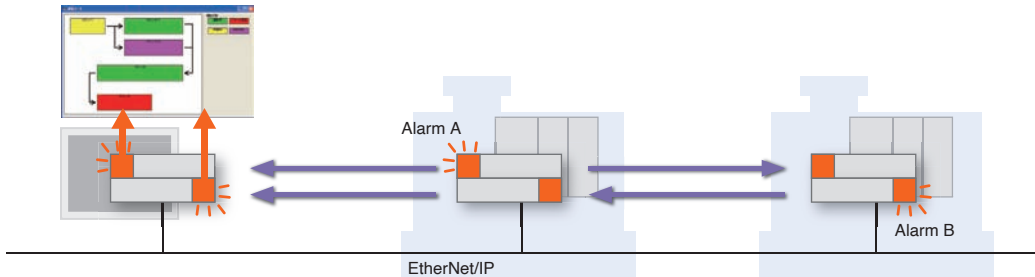

Main CX-Compolet Functions

Interface	Function	Description
Properties	Communications with OMRON PLCs	Specifies the PLC to communicate with, and reads network information.
	Reading and writing I/O memory	Read and writes data in memory areas, such as the DM Area or CIO Area. For example, DM word 100 can be specified by using "D100" or by using a tag name.
	Operating status	Reads and changes the operating mode.
	Area information	Reads information such as the program area size and number of DM Area words.
	Error information	Reads the value and error message when an error occurs.
	Other OMRON PLC information	Reads the model and reads and changes the clock.
	Getting tag information	Gets the NJ/NX/NY-series / CJ2 (with EtherNet/IP functionality) tag name list.
Methods	Reading and writing I/O memory	Reads and writes memory, such as consecutive words in the DM Area or CIO Area. For example, it is possible to specify the data type (integer, single, etc.) or change the data type (BCD, BIN, SBIN).
	Creating I/O tables	Creates the I/O tables for the present configuration.
	Force-setting, force-resetting and clearing bits	Force-sets, force-resets, and clears bits.
	Communications with OMRON PLCs	Specifies the PLC to communicate with.
	FINS service execution	Sends FINS commands and gets the responses that are received.
	Uploads the event log from the PLC *	Uploads the specified category of the event log from the PLC. The date/time and type (system event, access event, or user-defined event) of the past errors stored in the PLC can be uploaded collectively or by category.
Getting processing time of reading or writing value of tags	Gets statistical information (minimum value, maximum value, average value) of processing time for reading or writing values of tags. (Version 1.74 or higher)	
Events	Scheduled events	Events occur at regular intervals.

* Supported only by the NJ/NX-series Machine Automation Controllers and NY-series Industrial PC.
 The event log of the Communications Coupler Units, NX Units, EtherCAT slaves, or CJ-series Units cannot be uploaded.
 Refer to the Troubleshooting Manuals of the CPU Units for details of the event log.

An OMRON PLC Driver with Virtual PLC Memory Functionality

SYSMAC Gateway

Communications Driver and Virtual PLC Memory

SYSMAC Gateway provides an OMRON PLC communications driver and virtual memory. OMRON's FA Communications Software uses the SYSMAC Gateway communications middleware as a common platform.

- In addition to FINS communications, operation of SYSMAC Gateway has been verified on EtherNet/IP.
- Virtual PLC event memory is provided to enable a personal computer to participate as a data link node.
- Changes to memory can be detected in applications at the personal computer.
- The status of SYSMAC Gateway (EtherNet/IP communications) can be checked in task tray.

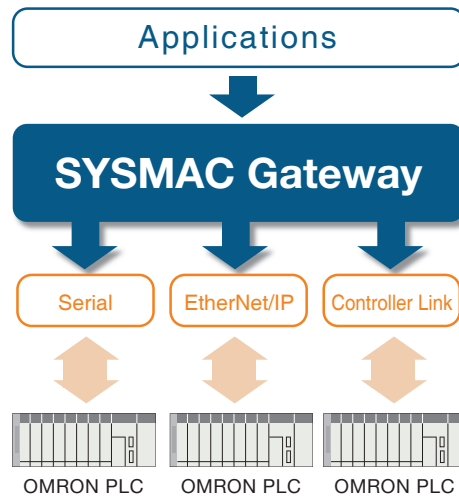

Note: Communications are possible via USB and Ethernet too.

Situation → Developing or Modifying PLC Applications Is Too Much Work

Problem		Solution	
Customers who have created their own communications programs	Modifying programs for different networks is a lot of work.	Time spent on programming communications can be reduced by absorbing the differences between networks.	
Customers who are already using FinsGateway	-Insufficient speed. -Insufficient data link capacity.	Using EtherNet/IP enables high-speed, large-capacity data links with no need for a special communications board.	
	Programming communications to send and receive messages for each node or block of data is too much work.	Communications efficiency can be optimized by using EtherNet/IP data links.	
Customers who want to standardize personal computer applications	Having to modify personal computer applications whenever the PLC memory map is changed is too much work.	For the CJ2 (with EtherNet/IP functionality) or NJ/NX/NY, tag access and tag data links (*1) provide freedom from PLC memory maps.	

Task Tray Notification and Troubleshooter

Statuses of EtherNet/IP communications (network, tags, operation history) are displayed. Explicit Message Task Monitor allows you to check the load for CIP message communications processing within SYSMAC Gateway, helping you analyze causes of communications problems related to processing loads.

Event Log Utility

This utility provides the functionality to upload and display the event log information recorded in the NJ/NX-series Machine Automation Controllers, Industrial PC Platform NY-series IPC Machine Controller.

Application Example

Using Events to Provide Notification of Changes in Data

- The application is notified using events only when preset conditions are met.
- Eliminating programming for checking cyclic data changes reduces the load on the personal computer processor.
- Notification of data changes is provided immediately, eliminating wasted communications time.

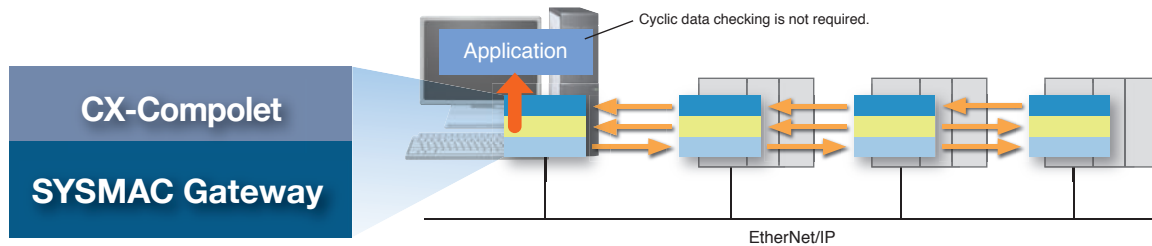

Main SYSMAC Gateway Functions

Item	Description
Supported protocols	SYSWAY, SYSWAY-CV, Peripheral Bus (Toolbus), FINS, and CIP
Supported PLCs	NX, NJ, NY, CJ2, CJ1, CS1, CP1, C, and CVM1 / CV
Supported networks	Ethernet (FINS, Data link), EtherNet/IP (CIP, Data link), RS-232C (SYSWAY, SYSWAY-CV, Data link), USB, and Controller Link (FINS, Data link)
Virtual event memory	CIO, Auxiliary (A), Holding (H), Work (W), DM, and EM1 to EM1F
Tag access	For the CJ2 (with EtherNet/IP functionality) or NJ/NX/NY, access by tag name is enabled.

CIP Service Specifications

Item	Description	
Tag data links ^{*1}	Number of connections	1,536
	Allowable communications bandwidth	40,000pps ^{*2}
	Refresh period (RPI)	1 to 10,000ms (unit:1ms) ^{*3}
	Link data capacity	1,108,992words max.
Explicit messages	Data size per connection	722words (1,444bytes) max.
	Message send function (client)	CIP connectionless (UCMM) and CIP connection (Class 3) communications
	Message receive function (server)	CIP connectionless (UCMM) and CIP connection (Class 3) communications
	Data size	502bytes
	CIP routing	Not supported.

*1. Tag data links between SYSMAC Gateway and the NJ/NX-series CPU Unit or Industrial PC Platform NY-series IPC Machine Controller can be created within the CJ-series specifications for variable with basic data type, array variable, and structure variable. SYSMAC Gateway memory allocation of structure variable is the same as the CJ-series. But, the tag data link with internal port of NY series is impossible.

*2. Reference value. The performance depend on your personal computer and the execution status of Windows applications.

*3. The RPIs that can be set depend on the number of connections.

The Main APIs You Can Set with the SDK

CIP Communication

Basic operation	
CIPApp_openConnectionExplicit	Opens an explicit message connection (Class3/UCMM).
CIPApp_closeConnectionExplicit	Closes the explicit message connection.
CIPApp_sendRequestExplicit	Sends an explicit message.
CIPApp_receiveExplicit	Receives an explicit message.

Operation to manipulate send / receive data	
CIPUtil_constructNetworkPath	Constructs the Network Path for the explicit message to send.
CIPUtil_constructRequestPathWithCIA	Constructs the RequestPath for the explicit message to send, with class / instance / attributeID.
CIPUtil_constructRequestPathWithTagName	Constructs the RequestPath for the explicit message to send, with a tag name.

Getting internal information	
CIPPort_getStatus	Gets the network port status.
CIPPort_getConnectionStatus	Gets the datalink connection status.

Note: There are 12 other APIs.

Fins Communication

Basic operation	
Fins_sendData	Sends a FINS message.
Fins_receiveData	Receives a FINS message.

Getting internal information	
Fins_getNetworkInfo	Gets the network information.

Operation to manipulate send / receive data	
FinsHead_compose	Constructs the FINS message header.
FinsHead_composeResponse	Constructs the FINS response header.

Note: There are 13 other APIs.

Datalink / Event memory access

Memory read / write	
Em_readMemory	Reads data from event memory.
Em_writeMemory	Writes data to event memory.

event send / receive	
Em_sendEvent	Sends events.
Em_receiveEvent	Receives events.

Setting or clearing message-driven event reception	
Em_setCondition	Sets normal event-occurrence condition.
Em_clearCondition	Clears normal or wide-area event-occurrence condition.

Getting internal information	
Em_getConditionList	Gets the setting list of normal event conditions.

Note: There are 30 other APIs.

CX-Compolet and SYSMAC Gateway can access the PLCs in the following configurations.

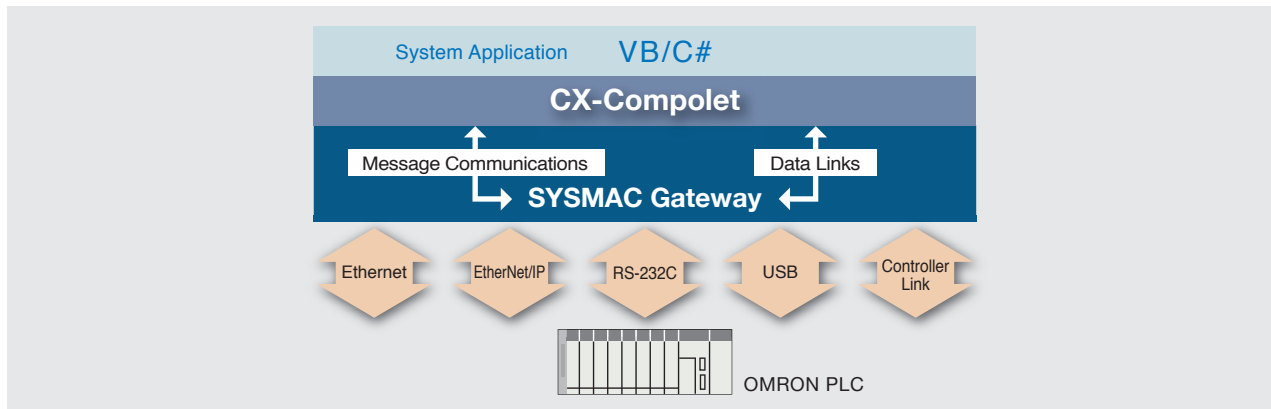

EtherNet/IP

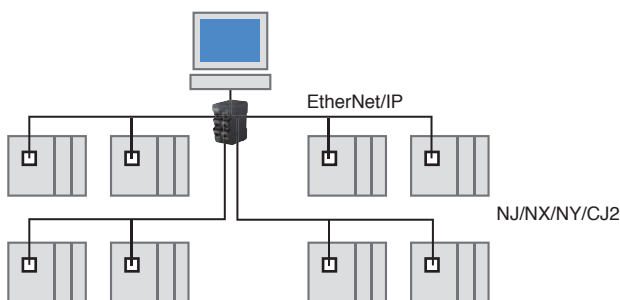

For systems linked with databases, the Database Connection CPU Unit is available. Please contact your OMRON sales representative for details.

USB

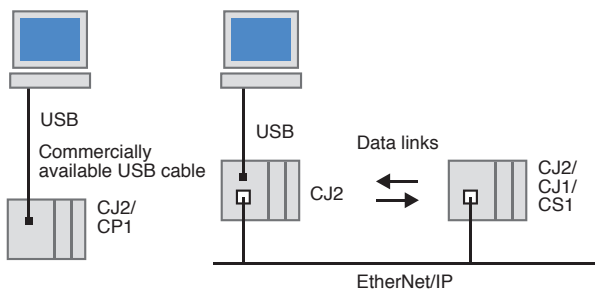

Ethernet (FINS)



RS-232C

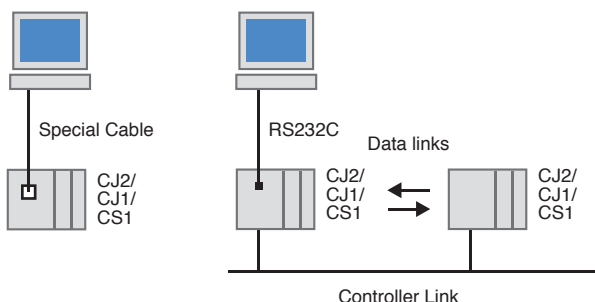

Controller Link

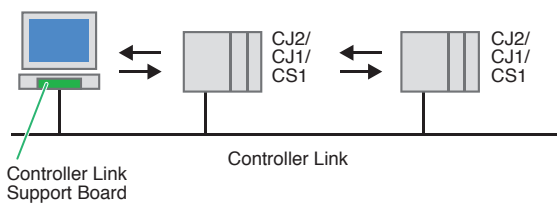

Note: The above configurations are only examples. Communications are also possible with PLCs other than those shown here. For details, refer to Correspondence between Main PLC Models and Connected Networks.

Application Example 1

Device controlled with PC (FPD manufacturing process)

- No special hardware for control network is required.

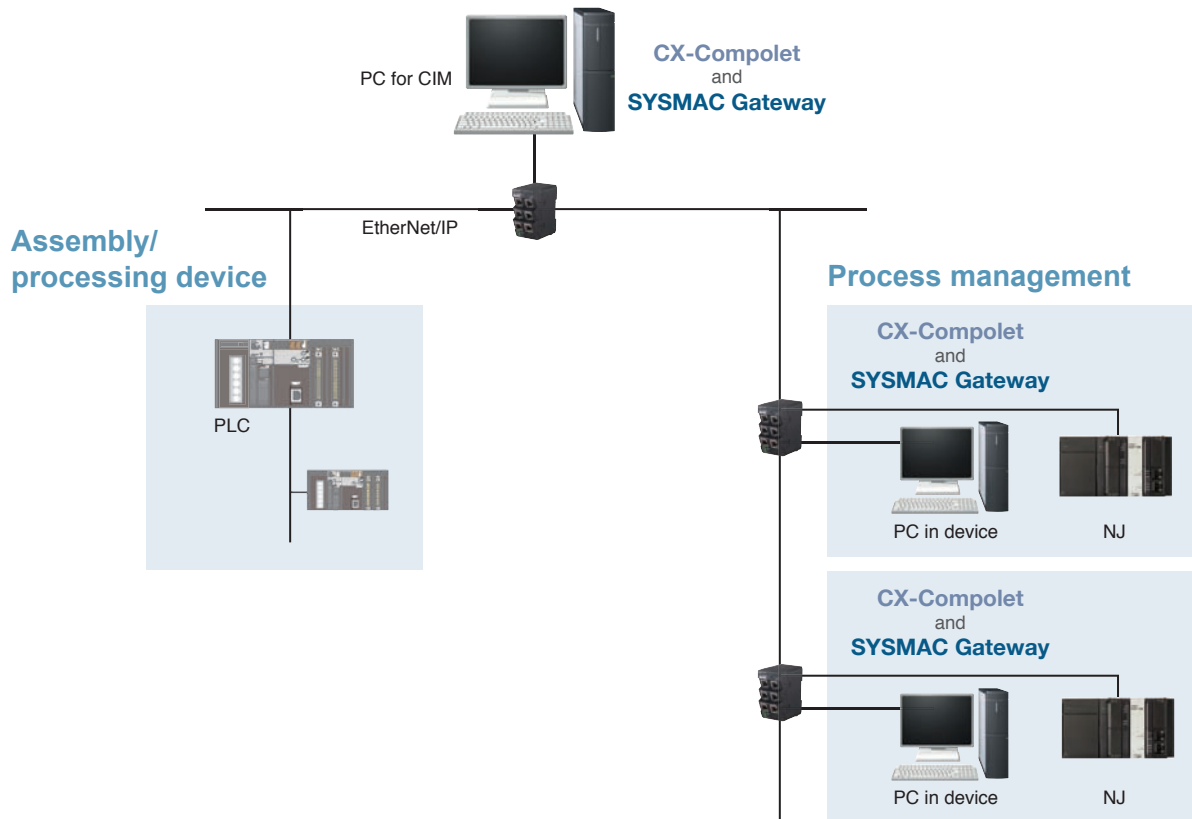

Application Example 2

Use of wireless LAN in notebook computer

- You can operate easily with a notebook computer because of EtherNet/IP data link communications without special hardware.

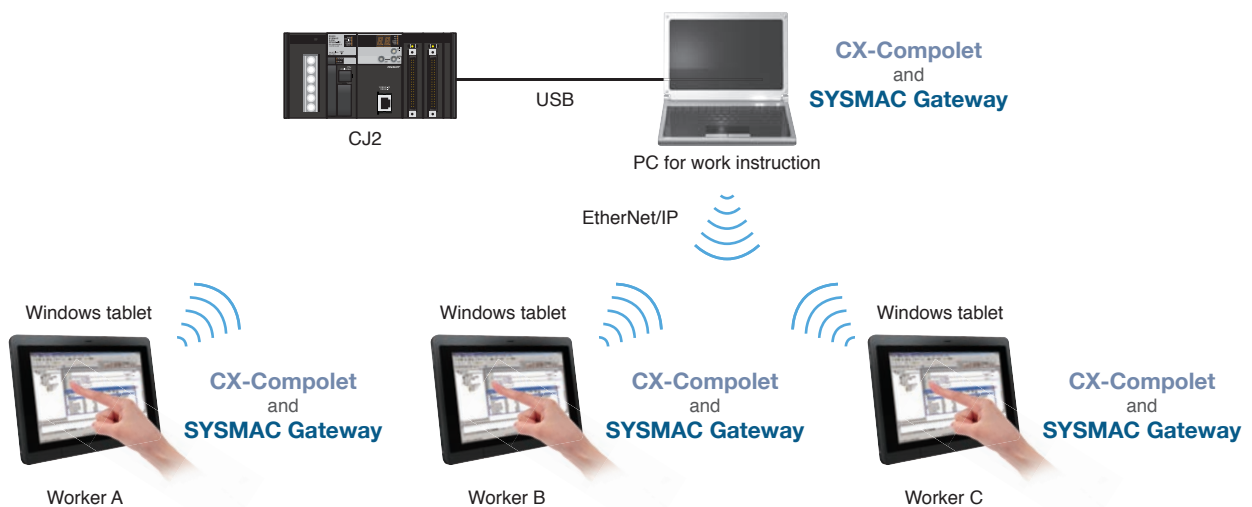

Note: The above configurations are application examples.
Make sure that you read the online help in the setup disk and check the operating conditions on site before using.

Ordering Information

■ CX-Compolet

Product	Specifications			Model
		Number of licenses	Media	
CX-Compolet *1	Software components that can make it easy to create programs for communications between a computer and controllers. Product includes CX-Compolet and SYSMAC Gateway functions.	1	DVD	WS02-CPLC1 *2
	Supported execution environment: .NET Framework (2.0, 3.0, 3.5, 4.6.1, 4.7 or 4.8)	3	—	WS02-CPLC1-L3
	Development environment: Visual Studio 2012/2013/2015/2017/2019/2022	5	—	WS02-CPLC1-L5
	Additional licenses (This product provides only additional licenses for WS02-CPLC1. Purchase of WS02-CPLC1 is required.)	10	—	WS02-CPLC1-L10
Development languages: Visual Basic, C# Supported communications: Equal to SYSMAC Gateway.	CX-Compolet (standalone) (SYSMAC Gateway functions are not included.)	1	CD-ROM	WS02-CPLC2

*1 One license is required per computer (execution environment).

*2 We offer RHEL type.

Please contact your OMRON sales representative for details.

■ SYSMAC Gateway (Communications Middleware)

Product	Specifications			Model
		Number of licenses	Media	
SYSMAC Gateway *1	Communications middleware for personal computers running Windows. Supports CIP communications and tag data links (EtherNet/IP) in addition to FinsGateway functions. (Fins Gateway functions are included.) Supported communications: RS-232C, USB, Controller Link, Ethernet, EtherNet/IP	1	CD-ROM	WS02-SGWC1
	Additional licenses (This product provides only additional licenses for WS02-SGWC1. Purchase of WS02-SGWC1 is required.)	10	—	WS02-SGWC1-L10
SYSMAC Gateway SDK	Software development kit for creating communications programs using SYSMAC Gateway. Development languages: C, C++	1*2	CD-ROM	WS02-SGWC1S

*1 One license is required per computer (execution environment).

*2 One license is required per computer (development environment). SYSMAC Gateway SDK doesn't include the license of SYSMAC Gateway.

Purchase the WS02-SGWC1 separately if an execution environment is required.

System Requirements (CX-Compolet / SYSMAC Gateway)

Item	Requirement
Operating system (OS) Japanese or English system *2	Microsoft Windows Server 2008 R2 (64bit*1) Microsoft Windows Server 2012 (64bit*1) Microsoft Windows Server 2012 R2 (64bit*1) Microsoft Windows Server 2016 (64bit*1) Microsoft Windows Server 2019 (64bit*1) Microsoft Windows Server 2022 (64bit*1) Microsoft Windows 7 SP1 (32bit/64bit*1) Microsoft Windows 8.1 (32bit/64bit*1) Microsoft Windows 10 (32bit/64bit*1) Microsoft Windows 11 (64bit*1)
Personal compute	Windows computers with Intel 32bit (x86) processor or 64bit (x64) -based processor
Hard disk	At least 400 MB of available space

*1 This software runs on WOW64 (Windows-On-Windows 64). Refer to the sample program included with the product to run applications as 64-bit processes.

*2 We offer RHEL type.

Please contact your OMRON sales representative for details.

Note 1: USB Port on the PC can not be shared between SYSMAC Gateway and CX-One in Windows Vista or higher.

Note 2: System requirements for Windows computers are the same as those recommended by Microsoft.

Note 3: The compatible functions of SYSMAC Compolet V2 are supported by Windows XP only.

Comparison between SYSMAC Gateway SDK and CX-Compolet

Yes : Supported, No : Not Supported

Communications Method	Protocols	Specifying memory areas	SYSMAC Gateway SDK (WS02-SGWC1S)	CX-Compolet+SYSMAC Gateway (WS02-CPLC1)
Message Communications	FINS	Physical address	Yes	Yes
	CIP	Physical address	Yes *1	Yes
		Tag names	No	Yes
Tag Data Links (EtherNet/IP)	CIP	Physical address	Yes *2	Yes
		Tag names	No	Yes
Development languages			C, C++	Visual Basic, C#

*1 Please use after understanding the CIP Communications Specifications.

*2 Data is transferred through the event memory.

Correspondence between Main PLC Models and Connected Networks

Yes : Supported, No : Not Supported

Personal computer		RS-232C				USB	Ethernet (LAN)		Controller Link
		SYSDWAY (Host Link C Mode)	SYSDWAY-CV (Host Link FINS)	CompoWay/F (master at personal computer)	Peripheral Bus		FINS	EtherNet (FINS)	
PLC									
NX7/NJ1 (unit version 1.10 or later) ^{*1} NJ5/NJ3 (unit version 1.03 or later) ^{*2} NX5 (unit version 1.60 or later) ^{*3} NX1 (unit version 1.30 or later) ^{*4} NX1P (unit version 1.13 or later) ^{*5} NY5□□-1 (unit version 1.12 or later) ^{*5} NX701-Z/NY5□□-Z (unit version 1.18 or later) ^{*6}		No	No	No	No	No	No	Yes ^{*7}	No
CJ2 with EtherNet/IP functionality		Yes	Yes	No	Yes (Peripheral Bus - CS/CJ)	Yes	Yes	Yes (Specification using tag names is possible.)	Yes ^{*8}
CJ1		Yes	Yes	No	Yes (Peripheral Bus - CS/CJ)	No	Yes ^{*8} (Communications Units are not required for CJ1M PLCs with EtherNet functionality.)	Yes ^{*8,9}	Yes ^{*8}
CS1		Yes	Yes	No	Yes (Peripheral Bus - CS/CJ)	No	Yes ^{*8}	Yes ^{*8,9}	Yes ^{*8}
CP1		Yes ^{*10}	Yes ^{*10}	No	Yes ^{*10} (Peripheral Bus - CS/CJ)	Yes	Yes ^{*11}	No	Yes ^{*8} (CP1H only)
C Series	C200HX/HG/HE, CQM1H	Yes	No	No	Yes (Peripheral Bus - C)	No	No	No	Yes ^{*8}
	CPM1/CPM2	Yes	No	No	Yes (Peripheral Bus - C)	No	No	No	No
CVM1/CV		Yes	Yes	No	Yes (Peripheral Bus - CV)	No	Yes ^{*8}	No	Yes ^{*8}
CompoWay/F Slaves, such as Temperature Controllers		No	No	Yes	No	No	No	No	No

Note: Including models whose production were/will be discontinued.

*1. To connect the NX701-1□□□/NJ101-□□□□ Controller, CX-Compolet / SYSDWAY Gateway version 1.70 or higher is required.

*2. To connect the NJ3/5 Controller, CX-Compolet / SYSDWAY Gateway version 1.31 or higher is required.

*3. To connect the NX502-1□□□ Controller, CX-Compolet / SYSDWAY Gateway version 1.81 or higher is required.

*4. To connect the NX1 Controller, CX-Compolet / SYSDWAY Gateway version 1.72 or higher is required.

*5. To connect the NX1P/NY5□□-1 Controller, CX-Compolet / SYSDWAY Gateway version 1.71 or higher is required.

*6. To connect the NX701-Z□□□/NY5□□-Z□□□□ Controller, CX-Compolet / SYSDWAY Gateway version 1.73 or higher is required.

*7. Tag data links between SYSDWAY Gateway and the NJ/NX-series CPU Unit or Industrial PC Platform NY-series IPC Machine Controller can be created within the CJ-series specifications for variable with basic data type, array variable, and structure variable. SYSDWAY Gateway memory allocation of structure variable is the same as the CJ-series.

But, the tag data link with internal port of NY series is impossible.

*8. A separate Communications Unit is required.

*9. Specification using tag names is not possible.

*10. It cannot be used for CP1E E-type.

*11. The CP1W-CIF41 is required for the CP1H / CP1L other than CP1L-EM/EL. The CP1W-CIF41 version 2.0 or later is required for the CP1E N-type. It cannot be used for CP1E E-type.

Correspondence between supported OS and Development environment & CX-Compolet / SYSDWAY Gateway

		Supported CX-Compolet/SYSDWAY Gateway	
Supported OS	Client	Windows 7 SP1 (32bit)	Ver.1.10 or higher
		Windows 7 SP1 (64bit)	Ver.1.20 or higher
		Windows 8.1 (32bit/64bit)	Ver.1.40 or higher
		Windows 10 (32bit/64bit)	Ver.1.70 or higher
		Windows 11 (64bit)	Ver.1.81 or higher
	Server	Windows Server 2008 R2 (64bit)	Ver.1.20 or higher
		Windows Server 2012/R2 (64bit)	Ver.1.50 or higher
		Windows Server 2016 (64bit)	Ver.1.72 or higher
		Windows Server 2019 (64bit)	Ver.1.80 or higher
	Windows Server 2022 (64bit)	Ver.1.81 or higher	
Development environment	Visual Studio 2012	Ver.1.50 or higher	
	Visual Studio 2013	Ver.1.40 or higher	
	Visual Studio 2015	Ver.1.70 or higher	
	Visual Studio 2017	Ver.1.72 or higher	
	Visual Studio 2019	Ver.1.80 or higher	
	Visual Studio 2022	Ver.1.81 or higher	

Note1: From SYSDWAY Gateway version 1.80, the unit revision has been changed to revision 4. When EtherNet/IP tag data links are set for SYSDWAY Gateway unit revision 1 to version 3, the settings need to be changed to revision 4 with Network Configurator for EtherNet/IP.

2: When EtherNet/IP tag data links are set to use SYSDWAY Gateway unit revision 4 (version 1.80 or higher) as a node, Network Configurator for EtherNet/IP version 3.72 or higher is required. (Network Configurator for EtherNet/IP is included in
 • CX-Compolet WS02-CPLC1 version 1.80 or higher
 • SYSDWAY Gateway WS02-SGWC1 version 1.80 or higher

3: If you need to upgrade to the latest version of CX-Compolet, consult you OMRON representative.

Correspondence between supported OS & Connected Networks

Yes : Supported, No : Not Supported

		Ethernet		RS-232C	USB	Controller Link	
		EtherNet (FINS)	EtherNet/IP			PCI	
Supported OS	Client	Windows 7 SP1 (32bit)	Yes	Yes	Yes	Yes	
		Windows 7 SP1 (64bit)					No
		Windows 8.1 (32bit/64bit)					No
		Windows 10 (32bit/64bit)					No
		Windows 11 (64bit)					No
	Server	Windows Server 2008 R2 (64bit)	Yes	Yes	Yes	Yes	No
		Windows Server 2012/R2 (64bit)	Yes	Yes	Yes	Yes	No
		Windows Server 2016 (64bit)	Yes	Yes	Yes	Yes	No
		Windows Server 2019 (64bit)	Yes	Yes	Yes	Yes	No
		Windows Server 2022 (64bit)	Yes	Yes	Yes	Yes	No

Technical Guide

Guide name	Man.No.	Description
CX-Compolet Application Design Guide for CIP communications	V240	Describes design procedure of applications using CX-Compolet and SYSMAC Gateway, operation check procedure, and troubleshooting communications errors.

Third party products

We will introduce software that supports CX-Compolet/SYSMAC Gateway and can be easily connected to OMRON NJ-series.

InduSoft, Inc.

InduSoft Web Studio

Powerful HMI, SCADA and OEE/Dashboard development software designed for deployment anywhere.



Features:

- Mobile accessibility via three types of thin clients, including Enhanced Studio Mobile Access, which offers access to process information on Android, iPhone and iPad.
- Over 240 native communication drivers, as well as support for OPC and direct integration to SYSMAC Gateway (former FINS Gateway).
- All the tools required to develop SCADA, HMI, and OEE/Dashboard applications, including: alarms, trending, reporting, and events.

Contact Us :
InduSoft, Inc.
info@indusoft.com
https://www.indusoft.com/

TAKEBISHI CORPORATION

DeviceXplorer OPC Server (Industrial Communications Software)

You will access to OMRON PLCs from SCADA, CAD, and other general-purpose package software.

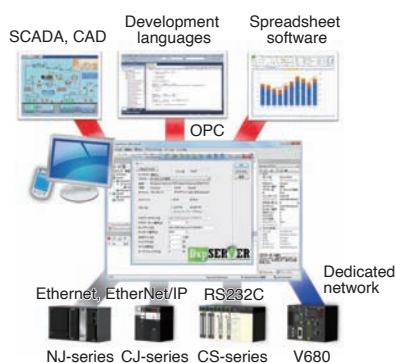

Features:

- Accessible to OMRON PLCs including new NJ series.
- Ideal for 24-hour continuous operation! Communications parameters can be changed while the system is running.
- OPC UA interface is the first software in Asia.

* World's first OPC server supporting NJ series as of July 2012.

Contact Us :
TAKEBISHI CORPORATION
fa-support@takebishi.co.jp
https://www.faweb.net/en/

Wellintech Co., Ltd

KingView (High-Performance software for Industrial Supervisory Control And Data Acquisition)

KingView allows you to develop Windows based control, monitoring, analyze and data collection applications.

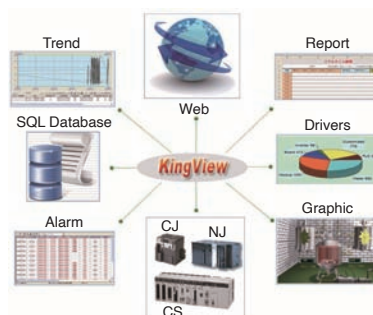

Features:

- Made by the SCADA manufacturer, who is the first to develop the NJ series driver worldwide, and is available in English, Chinese and Japanese. *
- Automatically read the variables of the NJ series and create on KingView.
- Communicate with series of OMRON PLCs.

* World's first SCADA supporting NJ series as of November 2011.

Contact Us :
Wellintech Co., Ltd
marketing@wellintech.com
http://www.kingview.com/

Note 1: OMRON can not guarantee the contents on this page. Please contact each company for details.

Note 2: Do not use this document to operate the Unit.

OMRON Corporation Industrial Automation Company

Kyoto, JAPAN

Contact : www.ia.omron.com

Regional Headquarters

OMRON EUROPE B.V.

Wegalaan 67-69, 2132 JD Hoofddorp
The Netherlands
Tel: (31) 2356-81-300 Fax: (31) 2356-81-388

OMRON ELECTRONICS LLC

2895 Greenspoint Parkway, Suite 200
Hoffman Estates, IL 60169 U.S.A.
Tel: (1) 847-843-7900 Fax: (1) 847-843-7787

OMRON ASIA PACIFIC PTE. LTD.

438B Alexandra Road, #08-01/02 Alexandra
Technopark, Singapore 119968
Tel: (65) 6835-3011 Fax: (65) 6835-3011

OMRON (CHINA) CO., LTD.

Room 2211, Bank of China Tower,
200 Yin Cheng Zhong Road,
PuDong New Area, Shanghai, 200120, China
Tel: (86) 21-6023-0333 Fax: (86) 21-5037-2388

Authorized Distributor:

©OMRON Corporation 2009-2023 All Rights Reserved.
In the interest of product improvement,
specifications are subject to change without notice.

CSM_17_1

Cat. No. V302-E1-19 0823 (0109)